

YASKAWA

Advanced Safety Module

for Sigma-7 SERVOPACK SGD7S-□□□DA0□8□□F91, 400 V

Product Manual

Model: SGD7S-OSB01A
SGD7S-OSB02A

To properly use the product, read this manual thoroughly and retain for easy reference, inspection, and maintenance. Ensure the end user receives this manual.

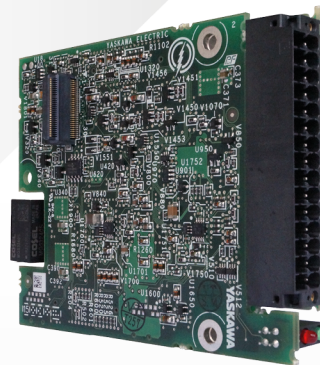

Table of contents

1	General	9
1.1	Information About This Operating Manual	9
1.2	Legend	10
1.3	Limitation of Liability	11
1.4	Related Documents	12
1.5	Technical Terms and Abbreviations	13
1.6	Safety Precautions That Must Always Be Observed	19
1.7	Approvals, Directives and Standards	20
1.8	Warranty	21
1.8.1	Details of Warranty	21
1.8.2	Limitations of Liability	21
1.8.3	Suitability for Use	22
1.8.4	Specifications Change	22
1.9	Use Of This Manual	22
1.10	Data Types	23
2	Safety Precautions	24
2.1	Overview	24
2.2	Contents of the Operating Manual	24
2.3	Alterations and Rebuilding of the Safety Module	24
2.4	Intended Use	24
2.5	User Responsibility	25
2.6	Protective Category	25
2.7	Personnel Training	25
2.8	Personal Protective Equipment	26
2.9	Special Dangers	26
2.10	Electric Safety	27
2.11	Notice on Power Supply	27
2.12	Safety Equipment	27
2.13	Conduct in the Event of Danger and Accidents	27
2.14	Signs	28
3	Main Characteristics for Functional Safety	29
3.1	Overview	29
3.2	Safety-Related Parameters for an Operation of 20 Years	29
3.3	SERVOPACK Installation Environment and Harmonized Standards	34
4	Checking Products	36
4.1	Overview	36
4.2	Unpacking	36
4.3	Checking Products on Delivery	36
4.4	Nameplate (Ratings) and Model Designation	37
4.5	Allowed compatible software versions	38

5	Specifications	39
5.1	Overview	39
5.2	General	39
5.3	Interaction With Other System Components	39
5.4	Safety Module Variants	39
5.5	Basic Specification of the Advanced Safety Module	40
5.6	Typical Reaction Time	40
5.7	Environmental Conditions	42
5.8	Board Outline	43
6	Wiring and Connection	44
6.1	Overview	44
6.2	SERVOPACK Installation	44
6.3	Safety Precautions	44
6.4	System Configuration Diagram	46
6.5	Electrical Specifications	49
6.5.1	Power Supply Specification	49
6.5.2	I/O Signal Connections	49
6.5.3	Digital Input Characteristics and Connections	52
6.5.4	Analog Input Characteristics and Connections	53
6.5.5	Digital Output Characteristics and Connections	57
6.6	Digital Input Configuration and Operation	62
6.7	Analog Input Configuration and Operation	63
6.8	Digital Output Configuration and Operation	64
6.8.1	Output Signal Behavior (Transition) of a Virtual Output, an EDM Output and a (Safe) Digital Output	65
6.8.2	Reaction Time of a Digital Output When a Safety Function Is Activated	66
6.8.3	Reaction Time of a Digital Output When an Alarm is Detected by the Safety Module	68
6.8.4	Reaction Time of SERVOPACK Safe State Request	68
6.9	EMC Installation Conditions	69
6.10	Concept Example for Safety Integrity Level	70
6.10.1	Overview	70
6.10.2	For Rotary Servomotors or Direct Drive Servomotors	71
6.10.3	For Linear Servomotors	72
7	Precautions and Basic Settings Required Before Starting Operation	74
7.1	Overview	74
7.2	General Safety Precautions	74
7.3	Safety Precautions for Using the Safety Module	76
7.4	Planning of a Safety-Oriented Control System	76
7.4.1	General	76
7.4.2	Risk Assessment	77

7.5	Limitations.	80
7.5.1	Limitations on the Use of the Test Without Motor Function.	80
7.5.2	Limitation When Setting the Communication Channel for the USB Connection.	80
7.5.3	Device Combination.	80
7.6	Basic Settings Required Before Starting Operation.	80
7.6.1	Overview.	80
7.6.2	Disabling the Test Without Motor Function.	81
7.6.3	Safety Option Module Setup Alarm Clear.	81
7.6.4	Configuration of the Motor and Encoder.	81
7.6.5	Setting Motor Information.	83
7.6.6	Setting Encoder Information.	83
7.6.7	Safety-Related Module Parameter Setting.	85
8	Safety Functions.	86
8.1	Overview.	86
8.2	Safety Features.	86
8.2.1	General.	86
8.2.2	Safety Functions Selection.	89
8.2.3	Safety Functions Activation.	90
8.3	Safe Torque Off (STO).	90
8.4	Safe Stop 1, Ramp Monitored (SS1-r).	92
8.5	Safe Stop 1, Time Monitored (SS1-t).	94
8.6	Safe Stop 2, Ramp Monitored (SS2-r).	96
8.7	Safe Stop 2, Time Monitored (SS2-t).	97
8.8	Safe Operating Stop (SOS).	99
8.9	Safely Limited Speed (SLS).	100
8.10	Safely Limited Acceleration (SLA).	102
8.11	Safe Speed Range (SSR).	103
8.12	Safe Direction (SDI).	105
8.13	Safely Limited Position (SLP).	107
8.14	Safely Limited Increment (SLI).	109
8.15	Safely Limited Torque (SLT).	111
8.16	Safe Motor Temperature (SMT).	113
8.17	Safe Cam (SCA).	115
8.18	Safe Speed Monitor (SSM).	117
8.19	Priority of Safety Functions.	119
8.20	Output Signal Behavior.	119
8.20.1	General.	119
8.20.2	Output Signal Behavior After a Limit Violation.	120
8.20.3	Limitations for Safety Functions.	122

9	Setting Parameters.	124
9.1	Overview.	124
9.2	Advanced Safety Module Parameter Editor.	124
9.2.1	Introduction.	124
9.2.2	General Device Parameters.	126
9.2.3	Motor and Encoder Parameters.	127
9.2.4	User Units.	127
9.2.5	I/O Configuration Parameters.	129
9.2.6	Safety Functions.	130
9.2.7	Double Confirmation.	130
9.2.8	Plausibility Checks.	130
9.2.9	Parameter Validation and Safe Container Creation.	131
9.2.10	System Validation and Operation.	138
9.3	Types of Parameters.	138
9.3.1	Overview.	138
9.3.2	Safety-Related Module Parameters.	138
9.3.3	Safety-Related Servo Parameters.	138
10	Set-Up and Replacement of the Safety Module.	140
10.1	Overview.	140
10.2	Initial Set-Up of a New Safety Module With a New SERVOPACK.	140
10.3	Parameterisation With the Advanced Safety Module Parameter Editor.	141
10.4	Replacement Procedure.	143
10.4.1	Initialisation of a New Safety Module With a SERVOPACK Already in Operation.	143
10.4.2	Initialisation of a Safety Module Already in Operation With a New SERVOPACK.	147
10.4.3	End of Use of the Safety Module.	150
10.5	Safety Module Detection Function.	150
10.5.1	Connected State Detection Function.	150
10.5.2	Solid Detection Function.	150
10.6	Safe Home Position (SHP).	151
11	Utility Functions.	156
11.1	Overview.	156
11.2	Utility Functions for Editing Parameters.	156
11.3	Utility Functions for Setup.	156
11.4	Utility Functions for Displaying Product Information.	163
12	Monitor Function.	165
12.1	Overview.	165
12.2	Monitoring Data via the Digital Operator and SigmaWin+.	165
12.2.1	General.	165
12.2.2	Monitor Function for SERVOPACK.	165
12.2.3	Monitor Function for Safety Module.	166
12.3	Tracing Data via SigmaWin+.	172

12.4	Monitoring Data via Network.	177
12.4.1	Overview.	177
12.4.2	FSoE (Fail-Safe over EtherCAT) Technology.	177
12.5	Status Display.	182
13	Active Mode Function.	183
13.1	Overview.	183
13.2	General.	183
13.3	Basic Functions.	183
13.3.1	Overview.	183
13.3.2	Internal Deceleration References.	184
13.3.3	Active Mode Hold Time.	184
13.3.4	Position Error Level for Releasing Active Mode.	185
13.3.5	Speed Reference Level for Releasing Active Mode.	186
13.4	Settings.	186
13.5	Return Method.	187
14	Troubleshooting.	189
14.1	Overview.	189
14.2	Safety Precautions.	189
14.3	List of Alarms.	190
14.4	Troubleshooting of Alarms.	192
14.5	Warnings.	198
15	Maintenance and Repair.	200
15.1	Safety Precautions.	200
15.2	Maintenance.	200
15.3	Repair.	200
16	Disassembly and Storage.	201
16.1	Overview.	201
16.2	Safety Precautions.	201
16.3	Safety Regulations.	201
16.4	Requirements on the Personnel Conducting the Work.	202
16.5	Disassembly.	202
16.6	Storage Conditions.	203
16.7	Recommissioning.	203
17	Disposal.	204
17.1	Overview.	204
17.2	Safety Precautions.	204
17.3	Safety Regulations.	204
17.4	Requirements on the Personnel Conducting the Work.	204
17.5	Disposal Instructions.	204
17.6	Recycling Collection Center/Offices.	204
18	Revision History.	205

19	Appendix	209
	Appendix.....	211
A	Reference List of Parameters	213
A.1	SERVOPACK Parameters (Pn).....	213
A.2	Safe Parameters.....	217
A.3	FSoE Parameters.....	258
A.4	Monitoring Parameters.....	271
B	EtherCAT Object List	278
B.1	Module Information Objects.....	278
B.2	EtherCAT Communication Objects.....	278
B.3	Application Objects.....	285
C	Device Combinations	310

1 General

1.1 Information About This Operating Manual

General Information	<p>This operating manual contains information for the entire life cycle of the Advanced Safety Module for Sigma-7 Series SERVOPACKs.</p> <p>Be sure to refer to this manual when performing design and maintenance in order to select and setup devices correctly.</p> <p>A copy of the source language manual is provided with all translated versions of this manual. If the translation contains unclear passages or inconsistencies, the original source language manual must be consulted for clarification and the manufacturer must be informed before the product that was purchased is used.</p> <p>Figures provided in this manual are typical examples or conceptual representations. There may be differences between them and actual wiring, circuits, and products.</p>
Product-Specific Information	<p>This operating manual provides important information for the use of an Advanced Safety Module (SGD7S-OSB01A respectively SGD7S-OSB02A) for a Sigma-7-Series SERVOPACK (SGD7S-□□□DA0□8□□F91) with a 400-VAC power input. It is aimed at qualified functional safety specialists who work with the product. Respect of the safety guidelines and instructions in this operating manual are prerequisites for the safe work.</p> <p>Furthermore, the local accident prevention legislation and general safety regulations applying to the safety module's field of application must also be complied with.</p> <p>Read the operating manual completely before starting work on the safety module. Pay special attention to the safety instructions. The operating manual is a component of the product and must be kept accessible in the immediate vicinity of the safety module at all times.</p>
Qualifications for the Intended User	<p>YASKAWA Europe GmbH has prepared this manual and the associated product for electrical and functional safety specialists and trained safety engineers who are experienced in installing, adjusting, inspecting and replacing parts of servo drives. Persons without technical training, minors, persons with disabilities or mental problems, persons with perception problems, and persons with pacemakers must not use or operate this product.</p>
Storage	<p>This operating manual is part of the product. It should be stored near the product and protected from environmental influences.</p> <p>At the sale of the product, this operating manual must be handed over to a specialist and to the operating personnel working with the product.</p>
Replacement	<p>If this manual becomes illegible or is lost, you can order a replacement from the manufacturer. For this purpose, you need the document number located on the cover sheet.</p>
Copyright	<p>YASKAWA Europe GmbH owns the copyright for all documentation containing the company signature of YASKAWA Europe GmbH.</p> <p>Without the prior written permission of YASKAWA Europe GmbH, no part of this documentation may be reproduced, stored in a retrieval system, or transmitted, in any form, or by any means, mechanical, electronic, photocopying, recording, or otherwise. No patent liability is assumed with respect to the use of the information contained herein.</p> <p>The content of this publication has been prepared with care to ensure that it conforms to the products described. As YASKAWA Europe GmbH is constantly striving to improve its high-quality products, the information contained herein is subject to change without notice.</p>

Legend

We also cannot completely exclude deviations due to the further development of the products described. However, the information contained herein is checked regularly and necessary corrections are included in subsequent editions of this publication.

All rights reserved.

Replacement Parts

**WARNING**

Improper or defective replacement parts can lead to damage, malfunctions or total failure.

Therefore, procure and use only original replacement parts.

If you need a replacement for your product, please contact your authorized dealer.

Disposal

Before disposing the product, destroy its functionality.

The marking of the product with the crossed-out wheeled bin symbol means that the product should be sent to the recycling system at the end of its life. You should dispose of it separately at an appropriate collection point and not put it in the normal waste stream.

See also → [‘Disposal’...page 204](#).

Customer Service

Our customer service is available for technical support.

Information on the competent contact person can be found at any time via telephone, fax, E-mail or over the Internet.

Terms Used

A list of the terms and abbreviations used can be found in → [‘Technical Terms and Abbreviations’...page 13](#).

Trademarks

- EtherCAT® is a registered trademark and patented technology, licensed by Beckhoff Automation GmbH, Germany.
- Safety over EtherCAT® is a registered trademark and patented technology, licensed by Beckhoff Automation GmbH, Germany.
- Other product names and company names are the trademarks or registered trademarks of the respective company. “TM” and the ® mark do not appear with product or company names in this manual.

Certification

The Advanced Safety Module for Sigma-7-Series SERVOPACKs from YASKAWA Europe GmbH has been developed in accordance with the standards specified in → [‘Approvals, Directives and Standards’...page 20](#) and certified by TÜV SÜD.

TÜV certificate number	Z10 112111
Test report number	YE96393T
Notified body	TÜV SÜD Product Service GmbH
Notified body number	0123

1.2 Legend

In operating manuals, instructions and notices draw the reader’s attention to situations that may result in personal injury or material damage if these instructions and notices are not observed.

Safety Instructions

Safety instructions draw attention to potential health hazards. To prevent personal injury and equipment damage in advance, the following signal words are used to indicate safety instructions in this document. The signal words are used to classify the hazards and the degree of damage or injury that may occur if a product is used incorrectly. The general safety sign in the following examples may be replaced by a specific sign in the case of concrete safety instructions. Information marked as shown below is important for safety. Always read this information and heed the precautions that are provided.

**DANGER**

... notifies of an imminent dangerous situation which will lead to death or serious injuries if not avoided.

**WARNING**

... notifies of a potentially dangerous situation which can lead to death or serious injuries if not avoided.

**CAUTION**

... notifies of a potentially dangerous situation which can lead to minor or slight injuries if not avoided.

Notices

Notes indicate how to use the product correctly and avoid damage to property.

**NOTICE**

... notifies of a potentially dangerous situation which can lead to property damage if not avoided.

Recommendations

... draw attention to useful tips and recommendations as well as information for efficient and trouble-free operation.

1.3 Limitation of Liability

General Information

All statements and instructions in this operating manual have been compiled in compliance with the applicable standards and legislation while taking the current level of technology and our long-term experience and findings into account.

The actual scope of materials delivered can vary from the explanations and illustrations described here in the event of custom designs, the use of additional ordering options or due to the most recent changes in technology.

The user assumes the responsibility of conducting maintenance and commissioning in accordance with the safety regulations of the applicable standards and all other relevant national or regional legislation relating to conductor dimensioning and protection, grounding, circuit breakers, overvoltage protection, etc.

The person who conducted the assembly or installation shall be accountable for damages occurring during assembly or connection.

Hardware

This operating manual, especially the safety instructions, must be observed during all tasks performed with the product. In addition, all rules and regulations that are applicable at the product's place of use must be observed.

Related Documents

Warranty and liability claims are excluded if they result from one or more of the following causes:

- Non-compliance with this operating manual
- Improper use
- Deployment of untrained personnel
- Use of non-approved replacement parts or accessories
- Non-permissible structural changes to the product
- Outside influences or acts of God

Software

The software was developed with reference to technical programming standards and subjected to extensive functional testing. However, the possibility of the program itself containing errors or generating errors when interacting with other applications cannot be excluded, nor possible limited functionality resulting from these errors.

Warranty and liability claims are excluded if they result from one or more of the following causes:

- Non-compliance with this operating manual
- Improper use
- Deployment of untrained personnel
- Improper installation
- Impermissible or improper changes to the parameters of devices
- Outside influences or acts of God

1.4 Related Documents

Refer to the following manuals as required.

Name	Selecting Models and Peripheral Devices	Ratings and Specifications	System Design	Panels and Wiring	Trial Operation	Trial Operation and Servo Adjustment	Maintenance and Inspection
Σ-7-Series AC Servo Drive Σ-7S SERVOPACK with 400V-Input Power and EtherCAT (CoE) Communications References FT/EX Specification for Advanced Safety Module Product Manual (SIEP S800002 30)	✓	✓	✓	✓	✓	✓	✓
Σ-7-Series AC Servo Drive Rotary Servomotor with 400 V-Input Power Product Manual (SIEP S800001 86)	✓	✓	✓	✓			✓
Σ-7-Series AC Servo Drive Linear Servomotor with 400 V-Input Power Product Manual (SIEP S800001 81)	✓	✓	✓	✓			✓
Σ-7-Series AC Servo Drive Digital Operator Operating Manual (SIEP S800001 33)					✓	✓	
Σ-7-Series AC Servo Drive Σ-7S and Σ-7W SERVOPACK with 400 V-Input Power Safety Precautions (TOMP C710828 02)	✓			✓			✓
Σ-7 Series Advanced Safety Module Instruction Manual (TOMP YEUS07S 01)				✓			
Σ-7 Series Advanced Safety Module Application Manual (SIEP YEUS07S 02)						✓	

Name	Selecting Models and Peripheral Devices	Ratings and Specifications	System Design	Panels and Wiring	Trial Operation	Trial Operation and Servo Adjustment	Maintenance and Inspection
Σ Series Digital Operator Safety Precautions (TOBP C730800 00)							✓
AC Servo Drive Rotary Servomotor Safety Precautions (TOBP C230260 00)				✓			✓
AC Servomotor Linear Σ Series Safety Precautions (TOBP C230800 00)				✓			✓
Σ-V-Series AC Servo Drive Universal Feedback Module Type 4 User's Manual (YEU SIEP C720829 23)				✓			
Σ-V Series Feedback Option Module Installation Guide (YEU TOEP C720829 03)				✓			

1.5 Technical Terms and Abbreviations

The following table shows the meaning of the terms and abbreviations used in this manual.

Term	Description	Standard
1oo2	Structure 'One out of two'. In the event of a fault, one channel is necessary to switch off safely. Hardware Fault Tolerance = 1	IEC 61508
Acceleration Monitoring	The safety module is monitoring acceleration operation of the motor	
Alarm	When the Alarm signal is active, the SERVOPACK will execute the STO.	
Base Block (BB)	Power supply to the motor is turned off by shutting off the base current to the power transistor in the SERVOPACK that supplies power to the motor	
Constant-speed Monitoring	The safety module is monitoring constant-speed operation of the motor	
Deceleration Monitoring	The safety module is monitoring deceleration operation of the motor	
Digital Operator	Hand-held operator connected to SERVOPACKs	
DIN	German Institute for Standardization (D eutsches I nstitut für N ormung)	
EDM	External Device Monitor. The EDM signal can be used to pass on the status of a safety function to an external device.	
EMC	Electromagnetic compatibility	
EN	European Standard (E uropäische N orm)	
FMEA	Failure mode and effects analysis	DIN EN 60812
FSoE	Fail-safe over EtherCAT based on safety protocol EtherCAT; Protocol for transferring safety data up to SIL3 between FSoE devices	
Hardware Base Block Function (HWBB)	Safety function in the SERVOPACK that is equivalent to the Safe Torque Off function defined in IEC 61800-5-2	
IEC	International Electrotechnical Commission	
I/O	Input/Output	
ISO	International Organization for Standardization	

Technical Terms and Abbreviations

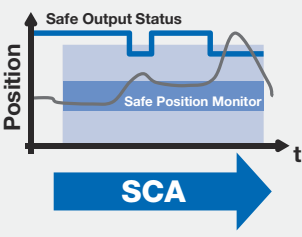
Term	Description	Standard
LED	Light emitting diode	
Linear Servomotor	A Sigma-7 Series Linear Servomotor (SGLG, SGLF or SGLT).	
MTTFd	Mean Time To Failure dangerous	
PFD	Probability of dangerous Failure on Demand	
PFH	Probability of dangerous Failure per Hour	
PL	Performance Level	ISO 13849
Position Monitoring	The safety module is monitoring the distance that the motor moved	
Proof Test	This is the test that is used to detect the failure of the safety-related system.	IEC 61508-4
Rotary Servomotor	A generic term used for a Sigma-7 Series Rotary Servomotor (SGM7J, SGM7A, SGM7P or SGM7G) or a Direct Drive Servomotor (SGMCS or SGMCV). The descriptions will specify when Direct Drive Servomotors are excluded.	
Safe Port	Dual Input/Output Channel	
Safe State	In the context of a standard safety function, the Safe State corresponds to the Hardware Base Block function (HWBB), which in turn corresponds to the Safe Torque Off function according to IEC 61800-5-2. The Safe State is achieved by de-energizing the motor.	
Safety Function Slot	A set of parameters to select and configure a safety function. A single safety function slot contains a parameter for the input selection, for the function selection, for the output selection and the behavior of the output signal. Additionally, there are parameters to configure the selected safety function.	
Safety Module	Advanced Safety Module for Sigma-7 Series SERVOPACKs, the option module that provides safety functions specified in this manual	
Safety-related Module Parameter	Parameter related to the safety functions of the safety module	
Safety-related Servo Parameter	These parameters contain the information related to the safety functions of SERVOPACKs and servomotors, and are managed by the safety module.	
SCA	<p>Safe Cam</p>  <p>This function provides a safe output signal to indicate whether the motor shaft position is within a specified range.</p>	IEC 61800-5-2

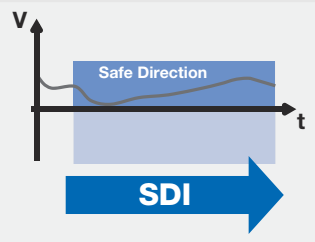
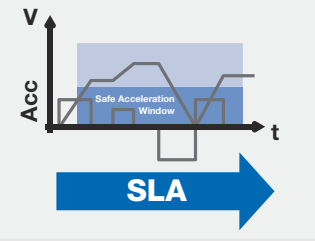
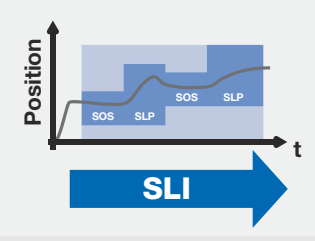
Term	Description	Standard
SDI	Safe Direction  <p>This function prevents the motor from moving in an invalid direction. If the specified direction is violated, STO will be applied.</p>	IEC 61800-5-2
Servo Drive	A set combining a Servomotor and a SERVOPACK	
Servomotor	A Sigma-7 Series Rotary Servomotor, Direct Drive Servomotor, or Linear Servomotor	
Servo ON	Power supply to the motor ON	
Servo OFF	Power supply to the motor OFF	
SERVOPACK (SV)	A Sigma-7 Series Servo Amplifier (e.g. SGD7S)	
Servo System	A servo control system that includes the combination of a Servo Drive with a host controller and peripheral devices	
SIL	Safety Integrity Level	
SLA	Safely Limited Acceleration  <p>This function monitors the acceleration operation of the motor. If the specified acceleration speed is exceeded during the acceleration speed monitoring, the selected motor stopping method will be applied.</p>	IEC 61800-5-2
SLI	Safely Limited Increment  <p>The motor is allowed to travel a permitted distance after a start command. A safe stop function must be triggered once the limit value is reached. If the permitted distance is exceeded, STO or the selected motor stopping method will be applied.</p>	IEC 61800-5-2

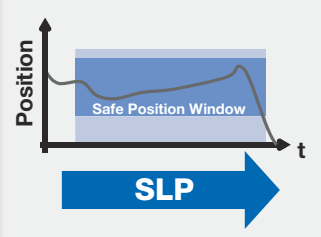
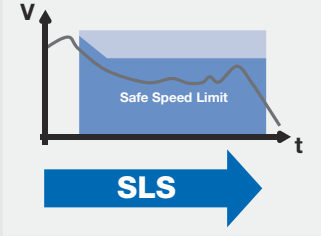
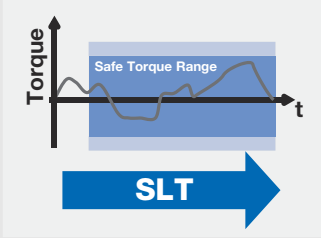
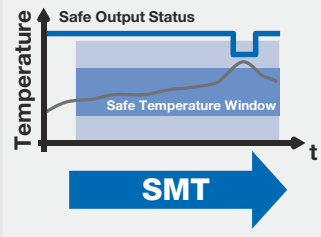
Term	Description	Standard
SLP	<p>Safely Limited Position</p>  <p>Safe position monitoring ensures that the motor does not exceed a pre-set position limit value. If a limit value is violated, the selected motor stopping method will be applied.</p>	IEC 61800-5-2
SLS	<p>Safely Limited Speed</p>  <p>This function monitors the deceleration operation of the motor until the time period specified in the parameter elapses, and then monitors the motor speed to make sure it is within the allowable range. If the specified speed is exceeded during motor speed monitoring, the selected motor stopping method will be applied.</p>	IEC 61800-5-2
SLT	<p>Safely Limited Torque</p>  <p>This function monitors the torque after a waiting time and compares it to the pre-set limit. If the torque limit is violated, the selected motor stopping method will be applied.</p>	IEC 61800-5-2
SMT	<p>Safe Motor Temperature</p>  <p>This function provides a safe output signal to indicate whether the motor temperature is below a specified limit.</p>	IEC 61800-5-2

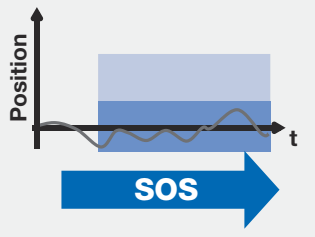
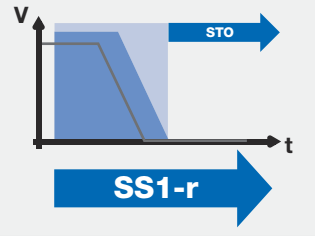
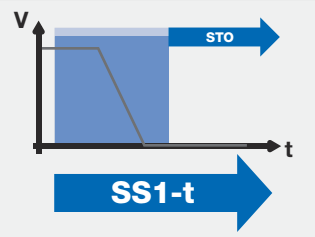
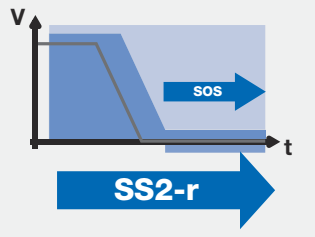
Term	Description	Standard
SOS	<p>Safe Operating Stop</p>  <p>This function monitors the distance that the motor moved to make sure it is within the allowable range. If the allowed range during position monitoring is exceeded, STO will be applied.</p>	IEC 61800-5-2
SS1-r	<p>Safe Stop 1, Deceleration Controlled</p>  <p>Safety function that monitors deceleration of the motor and executes the STO function if the specified speed is exceeded during motor speed monitoring.</p>	IEC 61800-5-2
SS1-t	<p>Safe Stop 1, Time Controlled</p>  <p>Safety function that starts deceleration of the motor and executes the STO function after a specified time has passed.</p>	IEC 61800-5-2
SS2-r	<p>Safe Stop 2, Deceleration Controlled</p>  <p>Safety function that monitors deceleration of the motor and executes the STO function if the specified speed is exceeded during motor speed monitoring. After deceleration monitoring the function switches to position monitoring and prevents the motor from stopping at a distance greater than the allowable deviation from the specified position.</p>	IEC 61800-5-2

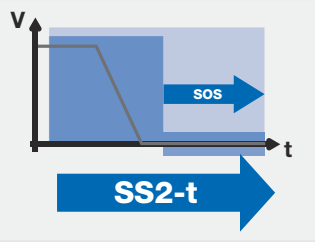
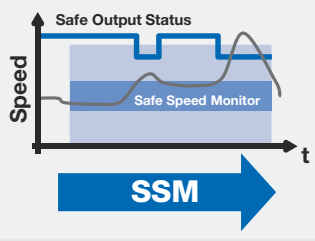
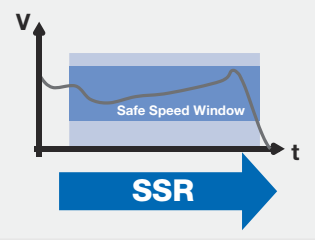
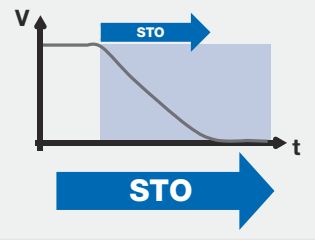
Term	Description	Standard
SS2-t	<p>Safe Stop 2, Time Controlled</p>  <p>Safety function that starts deceleration of the motor. After a specified time has passed, the function switches to position monitoring and prevents the motor from stopping at a distance greater than the allowable deviation from the specified position.</p>	IEC 61800-5-2
SSM	<p>Safe Speed Monitor</p>  <p>This function provides a safe output signal to indicate whether the motor speed is below a specified limit.</p>	IEC 61800-5-2
SSR	<p>Safe Speed Range</p>  <p>This safety function can be used to monitor a safe minimum speed, as well as an upper speed limit. It can generally be used for permanent process monitoring. If the specified speed is violated, the selected stopping method will be applied.</p>	IEC 61800-5-2
STO	<p>Safe Torque Off</p>  <p>Safety function that shuts OFF the power supply to the motor by executing the HWBB function of the SERVOPACK.</p>	IEC 61800-5-2
System Reset	<p>Resets the servo system by shutting OFF the power or executing software reset.</p>	
Warning	<p>The warning signal will be active if there is a limit violation in a safety function which uses the SS1 or SS2 as stopping method.</p>	

1.6 Safety Precautions That Must Always Be Observed



DANGER

- Do not remove covers, cables, connectors, or optional devices while power is being supplied to the SERVOPACK.
There is a risk of electric shock, operational failure of the product, or burning.



WARNING

- Use a power supply with specifications (number of phases, voltage, frequency, and AC/DC type) that are appropriate for the product.
There is a risk of burning, electric shock, or fire.
- Do not attempt to disassemble, repair, or modify the product.
There is a risk of fire or failure.
The warranty is void for the product if you disassemble, repair, or modify it.



CAUTION

- Please make sure that the servo drive is completely disconnected from the power supply and the charge LED is off.
There is a risk of electric shock.
- For a 24 V DC power supply, use a power supply device with double insulation or reinforced insulation.
There is a risk of electric shock.
- Do not damage, pull on, apply excessive force to, place heavy objects on, or pinch cables.
There is a risk of failure, damage, or electric shock.
- The person designing the system using any of the safety functions of the safety module must have full knowledge of the relevant safety standards and a complete understanding of the instructions in this document.
There is a risk of injury, product damage, or machine damage.
- Do not use the product in an environment that is subject to water, corrosive gases, or flammable gases, or near flammable materials.
There is a risk of electric shock or fire.



NOTICE

- Do not attempt to use any components that are damaged or that have missing parts.
There is a risk of product failure.



NOTICE

- Prevent electrostatic impact on the safety module and its connections.
There is a risk of product failure.

General Precautions

- The products shown in illustrations in this document are sometimes shown without covers or protective guards. Always replace all covers and protective guards before you use the product.
- Any and all quality guarantees provided by Yaskawa are null and void if the customer modifies the product in any way. Yaskawa disavows any responsibility for damages or losses that are caused by modified products.

1.7 Approvals, Directives and Standards

Document No.	Title
2006/42/EC	Machinery Directive
EN 61800-5-1:2007 EN 61800-5-1:2007/A1:2017 EN 61800-5-1:2007/A11:2021	Adjustable speed electrical power drive systems – Part 5-1: General requirements; Specification for the design of low voltage DC drive systems
IEC 61800-5-2:2016	Adjustable speed electrical power drive systems – Part 5-2: Safety requirements - Functional
IEC 61800-3:2017	Adjustable speed electrical power drive systems – Part 3: EMC requirements and specific test methods
ISO 13849-1:2015	Safety of machinery – Safety-related parts of control systems – Part1: General principles for design
ISO 13849-2:2012	Safety of machinery – Safety-related parts of control systems. Validation
EN IEC 62061:2021	Safety of machinery – Functional safety of safety related electrical, electronic and programmable electronic control systems
IEC 61508-1:2010	Functional safety of electrical/electronic/programmable electronic safety-related systems – Part 1: General requirements
IEC 61508-2:2010	Functional safety of electrical/electronic/programmable electronic safety-related systems – Part 2: Requirements for electrical /electronic/programmable electronic safety related systems
IEC 61508-3:2010	Functional safety of electrical/electronic/programmable electronic safety-related systems – Part 3: Software requirements
IEC 61508-4:2010	Functional safety of electrical/electronic/programmable electronic safety-related systems – Part 4: Definitions and abbreviations
IEC 61508-5:2010	Functional safety of electrical/electronic/programmable electronic safety-related systems – Part 5: Examples of methods for the determination of safety integrity levels
IEC 61508-6:2010	Functional safety of electrical/electronic/programmable electronic safety-related systems – Part 6: Guidelines on the application of IEC 61508-2 and IEC 61508-3
IEC 61508-7:2010	Functional safety of electrical/electronic/programmable electronic safety-related systems – Part 7: Overview of techniques and measures
EN IEC 61784-3:2021	Industrial communication networks – Profiles – Part 3: Functional safety field buses – General rules and profile definitions
EN 60204-1:2018	Safety of machinery – Electrical equipment of machines – Part 1: General requirements
EN 61326-3-1:2017	Electrical equipment for measurement, control and laboratory use – EMC requirements

Document No.	Title
IEC 61000-6-7:2014	Electromagnetic compatibility (EMC) – Part 6-7: Generic standards – Immunity requirements for equipment intended to perform functions in a safety-related system (functional safety) in industrial locations
SN 29500	Ausfallraten Bauelemente (Siemens standard for reliability prediction of electronic and electromechanical components)
UL 61800-5-1:2020-10-28	Adjustable Speed Electrical Power Drive Systems - Part 5-1: Safety Requirements - Electrical, Thermal and Energy This part specifies the requirement for adjustable speed drive systems or their elements, with respect to electrical, thermal and energy safety consideration.

1.8 Warranty

1.8.1 Details of Warranty

Warranty Period

The warranty period for a product that was purchased (hereinafter called “delivered product”) is one year from the time of delivery to the location specified by the customer or 18 months from the time of shipment from the Yaskawa factory, whichever is sooner.

Warranty Scope

Yaskawa shall replace a defective product free of charge if a defect attributable to Yaskawa occurs during the warranty period above. This warranty does not cover defects caused by the delivered product reaching the end of its service life and replacement of parts that require replacement or that have a limited service life.

This warranty does not cover failures that result from any of the following causes.

- Improper handling, abuse, or use in unsuitable conditions or in environments not described in product catalogs or manuals, or in any separately agreed-upon specifications
- Causes not attributable to the delivered product itself
- Modifications or repairs not performed by Yaskawa
- Abuse of the delivered product in a manner in which it was not originally intended
- Causes that were not foreseeable with the scientific and technological understanding at the time of shipment from Yaskawa
- Events for which Yaskawa is not responsible, such as natural or human-made disasters

1.8.2 Limitations of Liability

- Yaskawa shall in no event be responsible for any damage or loss of opportunity to the customer that arises due to failure of the delivered product.
- Yaskawa shall not be responsible for any programs (including parameter settings) or the results of program execution of the programs provided by the user or by a third party for use with programmable Yaskawa products.

- The information described in product catalogs or manuals is provided for the purpose of the customer purchasing the appropriate product for the intended application. The use thereof does not guarantee that there are no infringements of intellectual property rights or other proprietary rights of Yaskawa or third parties, nor does it construe a license.
- Yaskawa shall not be responsible for any damage arising from infringements of intellectual property rights or other proprietary rights of third parties as a result of using the information described in catalogs or manuals.

1.8.3 Suitability for Use

- It is the customer's responsibility to confirm conformity with any standards, codes, or regulations that apply if the Yaskawa product is used in combination with any other products.
- The customer must confirm that the Yaskawa product is suitable for the systems, machines, and equipment used by the customer.
- Consult with Yaskawa to determine whether use in the following applications is acceptable. If use in the application is acceptable, use the product with extra allowance in ratings and specifications, and provide safety measures to minimize hazards in the event of failure.
 - Outdoor use, use involving potential chemical contamination or electrical interference, or use in conditions or environments not described in product catalogs or manuals
 - Nuclear energy control systems, combustion systems, railroad systems, aviation systems, vehicle systems, medical equipment, amusement machines, and installations subject to separate industry or government regulations
 - Systems, machines, and equipment that may present a risk to life or property
 - Systems that require a high degree of reliability, such as systems that supply gas, water, or electricity, or systems that operate continuously 24 hours a day
 - Other systems that require a similar high degree of safety
- Never use the product for an application involving serious risk to life or property without first ensuring that the system is designed to secure the required level of safety with risk warnings and redundancy, and that the Yaskawa product is properly rated and installed.
- The circuit examples and other application examples described in product catalogs and manuals are for reference. Check the functionality and safety of the actual devices and equipment to be used before using the product.
- Read and understand all use prohibitions and precautions, and operate the Yaskawa product correctly to prevent accidental harm to third parties.

1.8.4 Specifications Change

The names, specifications, appearance, and accessories of products in product catalogs and manuals may be changed at any time based on improvements and other reasons. The next editions of the revised catalogs or manuals will be published with updated code numbers. Consult with your Yaskawa representative to confirm the actual specifications before purchasing a product.

1.9 Use Of This Manual

This manual contains information on the intended use of the Advanced Safety Module for Sigma-7 Series SERVOPACKs.

Knowledge of the regulations and proper technical implementation of the safety instructions in this manual by qualified personnel are prerequisites for the safe installation, commissioning and safety during the operation and maintenance of the safety module. Unqualified interference with the safety modules during shutdown or use of the safety

functions or failure to comply with the instructions of this manual can lead to serious personal injury, property damage or environmental harm, for which Yaskawa assumes no liability.

Yaskawa safety components and systems are developed, manufactured and tested in compliance with the applicable safety standards. They may only be used under the specified environmental conditions and only in connection with approved external safety modules.

The operating manual contains safety instructions, descriptions of the interfaces and information on the phases of the product's life cycle:

- Planning
- Installation/Assembly
- Commissioning
- Validation
- Operation
- Modification/Retrofitting
- Troubleshooting
- Maintenance/Repair
- Disassembly

1.10 Data Types

The following table lists the data types and ranges that are used in this manual.

Code	Data Type	Coding (decimal)	Range
BOOL	Boolean	1	FALSE, TRUE
SINT	Signed 8-bit integer	2	-128 to 127
INT	Signed 16-bit integer	3	-32,768 to 32,767
DINT	Signed 32-bit integer	4	-2,147,483,648 to 2,147,483,627
USINT	Unsigned 8-bit integer	5	0 to 255
UINT	Unsigned 16-bit integer	6	0 to 65,535
UDINT	Unsigned 32-bit integer	7	0 to 4,294,967,295

Intended Use

2 Safety Precautions

2.1 Overview

This chapter provides an overview of all important safety aspects for the optimum protection of the personnel as well as for safe and trouble-free operation at the machine or installation on site. The observance of this is an important precondition for the safe and trouble-free operation.

2.2 Contents of the Operating Manual

All persons assigned to work on or with the safety module must have read and understood this operating manual before beginning work with the safety module. This also applies if the person concerned has already worked with such a safety module or a similar safety module or has been trained by the manufacturer.

2.3 Alterations and Rebuilding of the Safety Module

In order to avoid hazards and ensure optimum performance, neither alterations, additions nor rebuilding work may be conducted on the safety module unless explicitly authorized by the manufacturer.

2.4 Intended Use

The safety module is an electrical equipment designed for being attached to an applicable Sigma-7 SERVOPACK. It is exclusively designed and constructed for the intended purpose of use described here.

It is used for monitoring and implementing safety functions within the framework of functional safety in a commercial application as defined by IEC 61508 and IEC 62061. Do not use this product for other functions.

You are using the safety module according to the terms, as soon as you regard all notes and information in this operating manual.



WARNING

Danger due to use other than intended!

Any use of the safety module different from and/or exceeding beyond the scope of the intended use can lead to dangerous situations.

Therefore:

- Only use the safety module as intended.
- Only use the safety module in combination with compatible devices
→ ['Device Combination'...page 80](#).
- Follow all specifications of this operating manual.
- Ensure that exclusively qualified personnel work on or with the safety module.
- Take care in project planning to see that the safety module is always used within its specifications.
- Ensure that the power supply meets the required specifications.
- Only operate the safety module if it is in technically faultless condition.
- Only use the safety module with certified components.

**WARNING**

When creating a safety design for a mechanical system using the safety functions of the safety module, always perform risk assessment of the system in accordance with DIN EN ISO 12100-1 and EN ISO 14121 to identify residual risks.

Improper use may result in injury or damage to the product.

2.5 User Responsibility

The safety module is designed for use in an industrial zone or industrial area. The user of the safety module is thus subject to the legal work safety obligations.

In addition to the work safety instructions in this operating manual, the safety, accident prevention and environmental protection regulations applicable to the area of application of this safety module must also be complied with. In doing so, the following applies in particular:

- The user must inform himself of the applicable work safety regulations and additionally ascertain hazards arise through the special work conditions at the place of use of the safety module in a risk analysis.
The user must implement these in the form of operation instruction for the total operation of the machine/application in dependence of the accordant risk assessment.
- This operating manual must be kept in the immediate vicinity of the safety module and be accessible to persons working on and with the safety module at all times.
- The statements of the operating manual are to be followed completely and absolutely!
- The safety module may only be operated in technically faultless condition and must be safe for operation.

2.6 Protective Category

IP00. When installed in the SERVOPACK, the safety module complies with the protective category of the SERVOPACK used.

2.7 Personnel Training

**WARNING**

Risk of injury if operated by insufficiently qualified persons!

Improper handling can lead to severe personal injury and property damage.

Therefore, only have certain activities carried out by persons specified in the respective chapters of this operating manual.

The following qualifications for various areas of operation are specified in the operating manual:

- **Operating personnel**
The drive system may only be operated by persons who have been trained, instructed and authorized to do so.
Troubleshooting, cleaning, maintenance and exchange may only be conducted by trained or instructed personnel. These persons must be familiar with the operating manual and act according to it.
Commissioning and instruction may only be conducted by qualified personnel.
- **Qualified personnel**
Electrical and functional safety specialists and safety engineers of the customer or a third party who are authorized by Yaskawa, trained and certified in the installation

Special Dangers

and commissioning of Yaskawa drive systems and commissioning, grounding and designating electrical systems and safety modules in accordance with the safety engineering standards.

Qualified personnel is educated or trained in the maintenance and use of suitable safety equipment in accordance with the respective local safety engineering standards.

2.8 Personal Protective Equipment

Wearing the appropriate personal protective equipment when working is required in order to minimize hazards to the health.

- Always wear the respective protective equipment required for the respective task when working.
- Check with your local safety authority what personal protective equipment is required according to local safety requirements.
- Observe signs on personal safety in the work area!

2.9 Special Dangers

The residual risks arising as a result of the hazard analysis will be specified in the following section.

Observe the safety instructions described here and the warning notices in the following chapters in order to reduce health hazards and avoid dangerous situations.

Electrical Current



DANGER

Live-threatening danger from electrical current!

There is a live-threatening danger at contact with live parts. The damage of the insulation or of a single part can be live-threatening.

Therefore:

- Switch off the voltage supply immediately if there is a damage of the insulation.
- Only qualified personnel may work at the electrical installation.
- De-energize the machine for all work with reference to the discharge times (e.g. the SERVOPACK DC-link) and protect against switching it on again.
- Observe the valid product safety standards when dealing with high-voltage equipment.

Moving Parts



WARNING

Danger of injury due to moving parts!

Rotating and/or linear moving parts can cause severe injuries.

Therefore:

- Do not interfere with moving parts during operation.
- Do not open covers during operation.
- The mechanical residual energy depends on the application. Powered parts will also keep rotating/moving for a certain time after the power supply has been shut off. Make sure to provide suitable safety equipment.

2.10 Electric Safety

The safety module is designed for contamination level 2 in accordance with DIN EN 61800-5-1. This means that only non-conductive contamination may appear.

This is achieved by installing the SERVOPACK with the safety module into a protected mounting location (at least IP 54, e.g. the mounting in a control cabinet). Short-term conductivity from condensation is only permissible if the module is not in operation.



WARNING

Risk of injury from conductive contaminants!

No conductive contaminants may appear during operation.

Therefore, before installing and commissioning the system, check that contamination level 2 is not exceeded (this can also be done by optical inspections, if necessary).

2.11 Notice on Power Supply



WARNING

Risk of injury from electric current!

Only safety devices which have a safe disconnection to the mains may be connected to the safety module.

The power supply unit for generating the 24 Volt supply must meet the requirements for SELV/PELV in accordance with EN 60204-1.

2.12 Safety Equipment



WARNING

Live-threatening danger from inoperable safety equipment!

Safety equipment provides a maximum of safety during operation. Even if the safety equipment may make work processes more complicated, they may not be put out of operation under any circumstances. Safety is only ensured if the safety equipment is intact.

Therefore, check the installed safety equipment before starting work. Make sure that the safety equipment is undamaged and has not been tampered with.

Verification and validation of the installed safety functions is required.

2.13 Conduct in the Event of Danger and Accidents

Preventive Measures

- Always be prepared for accidents or fire!
- Keep first aid equipment (first-aid box, blankets, etc.) and fire extinguishers on hand!
- Instruct personnel in accident reporting, first aid and rescue equipment.

In Case of Emergency: Act Properly

- Put the safety module out of operation immediately:
 - Always immediately EMERGENCY-OFF at electrical hazards like short-circuits, smoke, fire, lightning.
 - At mechanical hazards, if necessary EMERGENCY-STOP until the machine stops. Additionally, EMERGENCY-OFF.
- Keep people out of the danger zone.

Signs

- Introduce first aid measures.
- Inform the supervisors at the site.
- Notify a doctor and/or fire department.
- Clear access routes for rescue vehicles.

2.14 Signs

The following symbols and notification signs are found in the work area. They relate to their immediate installation environment.

**WARNING****Injury hazard due to illegible symbols!**

In the course of time, stickers and symbols on the safety module can become dirty or otherwise illegible.

Therefore, keep all safety, warning and operating signs on the safety module in a clearly legible condition at all times.

Electric Current

Only qualified personnel may work in work spaces with this marking.

Unauthorized persons may not touch work equipment bearing this marking.

3 Main Characteristics for Functional Safety

3.1 Overview

This chapter describes parameters in relation to functional safety. In accordance with IEC 61508, safety means first of all, that a system is free of unwarranted risks. Functional safety is the part of the overall safety, which ensures that a safety system's response to its input conditions is free of errors. Internal safety-related device errors must be detected and brought into a safe condition in the process.

3.2 Safety-Related Parameters for an Operation of 20 Years

The following table lists the safety-related parameters of the safety module for an operation of 20 years within the specified environmental range.

Safety-related parameters of local I/O terminals and decentralized components can be found in the applicable documentation. The values in the following table relate exclusively to the safety module.

Safe Performance

SGD7S-OSB01A

Items	Standards	Safety Details
Safety Integrity Level	IEC 61508	Up to SIL3
	IEC 62061	Up to SILCL3
Probability of Dangerous Failure per Hour	IEC 61508	PFH = $1.3 \times 10^{-9}/h$
	IEC 62061	PFH = $4.53 \times 10^{-9}/h$
Performance Level	EN ISO 13849-1	Up to PL e (Category 3)
Safe Failure Fraction (fraction of failures which lead to a safe status)	IEC 61508	SFF = 99.9 %
Mean Time To Failure dangerous	EN ISO 13849-1	MTTF _d = 400 years (HIGH)
Average Diagnostic Coverage	EN ISO 13849-1	DC _{avg} = 99.9 % (HIGH)
Stop Category	IEC 60204-1	Stop category 0/1/2
Safety Function ²	IEC 61800-5-2	STO / SS1-r / SS1-t / SS2-r / SS2-t / SOS / SLS / SLA / SSR / SDI / SLP / SLI / SCA / SSM
Mission Time	IEC 61508	20 years (The proof test interval is equal to the mission time.)
Hardware Fault Tolerance	IEC 61508	HFT = 1
Subsystem	IEC 61508	B

SGD7S-OSB02A

Items	Standards	Safety Details
Safety Integrity Level	IEC 61508	Up to SIL3
	IEC 62061	Up to SILCL3
Probability of Dangerous Failure per Hour	IEC 61508	PFH = max. $2.493 \times 10^{-8}/h$ ¹
	IEC 62061	PFH = max. $3.09 \times 10^{-8}/h$ ¹
Performance Level	EN ISO 13849-1	Up to PL e (Category 3)

Items	Standards	Safety Details
Safe Failure Fraction (fraction of failures which lead to a safe status)	IEC 61508	SFF = max. 95.6 % ¹
Mean Time To Failure dangerous	EN ISO 13849-1	MTTF _d = 100 years (HIGH) ¹
Average Diagnostic Coverage	EN ISO 13849-1	DC _{avg} = max. 91.2 % (MEDIUM) ¹
Stop Category	IEC 60204-1	Stop category 0/1/2
Safety Function ³	IEC 61800-5-2	STO / SS1-r / SS1-t / SS2-r / SS2-t / SOS / SLS / SLA / SSR / SDI / SLP / SLI / SLT / SMT ⁴ / SCA / SSM
Mission Time	IEC 61508	20 years (The proof test interval is equal to the mission time.)
Hardware Fault Tolerance	IEC 61508	HFT = 1
Subsystem	IEC 61508	B

1: Max. value with all I/O ports configured.

2: Available safety functions with FSoE.

3: Available safety functions with FSoE or I/O.

4: When using SMT with an internal analog PT1000 sensor, only SIL2 / PL e level is achieved.

The safety module can be used in applications as far as Cat 3/PL e according to EN ISO 13849-1 and SIL3 according to EN 62061 / IEC 61508.

No proof test is necessary during the expected service life of the safety module of up to 20 years.



CAUTION

If the user calculates his safety application for the specified values with 20 years, the safety module must be decommissioned after 20 years. This is the maximum service life of the device. The safety module must be properly disposed of → 'Disposal'...page 204.

Calculation of PFH (Probability of a Dangerous Failure per Hour) According to IEC 61508

Advanced Safety Module	CPU [1/h]	Per Safe DI [1/h]	Per Safe DO [1/h]	Per Safe AI [1/h]	Per Safe AI SIL2 (temperature/current) [1/h]
PFH	1.30×10^{-9}	1.79×10^{-12}	5.46×10^{-12}	4.11×10^{-12}	1.18×10^{-8}

Calculation of PFH (Probability of a Dangerous Failure per Hour) According to IEC 62061

Advanced Safety Module	CPU [1/h]	Per Safe DI [1/h]	Per Safe DO [1/h]	Per Safe AI [1/h]	Per Safe AI SIL2 (temperature/current) [1/h]
PFH	4.53×10^{-9}	1.79×10^{-10}	5.45×10^{-10}	4.11×10^{-10}	1.18×10^{-8}

For SGD7S-OSB01A:

$$PFH_{total} = PFH_{SERVOPACK} + PFH_{CPU} + PFH_{Encoder}$$

For SGD7S-OSB02A:

$$PFH_{total} = PFH_{SERVOPACK} + PFH_{CPU} + n_{Safe DI} \times PFH_{Safe DI} + n_{Safe DO} \times PFH_{Safe DO} \\ + n_{Safe AI} \times PFH_{Safe AI} + n_{Safe AI SIL2} \times PFH_{Safe AI SIL2} + PFH_{Encoder}$$

Fig. 1: Calculation of PFH (Probability of a Dangerous Failure per Hour) According to IEC 61508

To determine the SERVOPACK PFH value ($PFH_{SERVOPACK}$) refer to the Product Manual of the SERVOPACK.

Name	Manual number
Σ-7-Series AC Servo Drive Σ-7S SERVOPACK with 400V-Input Power and EtherCAT (CoE) Communications References FT/EX Specification for Advanced Safety Module Product Manual	SIEP S800002 30

Calculation of PFD (Probability of a Dangerous Failure on Demand) According to IEC 61508

Advanced Safety Module	CPU [1/h]	Per Safe DI [1/h]	Per Safe DO [1/h]	Per Safe AI [1/h]	Per Safe AI SIL2 (temperature/current) [1/h]
PFD	1.14×10^{-4}	1.57×10^{-7}	4.78×10^{-7}	3.60×10^{-7}	1.03×10^{-3}

For SGD7S-OSB01A:

$$PFD_{total} = PFD_{CPU} + PFD_{Encoder}$$

For SGD7S-OSB02A:

$$PFD_{total} = PFD_{CPU} + n_{Safe DI} \times PFD_{Safe DI} + n_{Safe DO} \times PFD_{Safe DO} \\ + n_{Safe AI} \times PFD_{Safe AI} + n_{Safe AI SIL2} \times PFD_{Safe AI SIL2} + PFD_{Encoder}$$

Fig. 2: Calculation of PFD (Probability of a Dangerous Failure on Demand) According to IEC 61508

To determine the SERVOPACK PFD value ($PFD_{SERVOPACK}$) refer to the Product Manual of the SERVOPACK.

Name	Manual number
Σ-7-Series AC Servo Drive Σ-7S SERVOPACK with 400V-Input Power and EtherCAT (CoE) Communications References FT/EX Specification for Advanced Safety Module Product Manual	SIEP S800002 30

Abbreviations used:

PFH: Probability of a Dangerous Failure per Hour

Safety-Related Parameters for an Operation of 20 Years

PFD: Probability of a Dangerous Failure on Demand

$n_{\text{Safe DI}}$: Number of used Safe Digital Inputs

$n_{\text{Safe DO}}$: Number of used Safe Digital Outputs

$n_{\text{Safe AI}}$: Number of used Safe Analog Inputs

$n_{\text{Safe AI SIL2}}$: Number of used Analog Inputs Single Channel

Yaskawa Encoder Safety Values

Motor / Encoder Type	λ_{Encoder} [FIT]	MTTF _{d Encoder} [years]	DC _{avg Encoder} [%]	PFH IEC 61508 [1/h]	PFD IEC 61508	PFH IEC 62061 [1/h]	SFF [%]
SGM7J-□□□7□□□□□□	683	230	95	1.7075 x 10 ⁻⁸	1.4959 x 10 ⁻³	1.7075 x 10 ⁻⁸	97.5
SGM7A-□□□7□□□□□□							
SGM7G-□□□7□□□□□□							
SGM7J-□□□F□□□□□□	592.2	230	95	1.4805 x 10 ⁻⁸	1.2970 x 10 ⁻³	1.4805 x 10 ⁻⁸	97.5
SGM7A-□□□F□□□□□□							
SGM7G-□□□F□□□□□□							
SGM7J-□□□6□□□□□□	834.7	230	95	2.0867 x 10 ⁻⁸	1.8281 x 10 ⁻³	2.0867 x 10 ⁻⁸	97.5
SGM7A-□□□6□□□□□□							
SGM7G-□□□6□□□□□□							
JZDP-H003-□□□ (Serial Converter)	631	230	95	1.5775 x 10 ⁻⁸	1.3820 x 10 ⁻³	1.5775 x 10 ⁻⁸	97.5
JZDP-H005-□□□ (Serial Converter for Linear Motor) ¹	553.6	230	95	1.384 x 10 ⁻⁸	1.2124 x 10 ⁻³	1.384 x 10 ⁻⁸	97.5
JZDP-H006-□□□ (Serial Converter for Linear Motor) ¹	621.2	230	95	1.553 x 10 ⁻⁸	1.3605 x 10 ⁻³	1.553 x 10 ⁻⁸	97.5
JZDP-H008-□□□ (Serial Converter for Linear Motor) ¹							
JZDP-J003-□□□ (Serial Converter for Linear Motor) ¹	550.5	230	95	1.3762 x 10 ⁻⁸	1.2057 x 10 ⁻³	1.3762 x 10 ⁻⁸	97.5
JZDP-J005-□□□ (Serial Converter for Linear Motor) ¹	473	230	95	1.1825 x 10 ⁻⁸	1.0359 x 10 ⁻³	1.1825 x 10 ⁻⁸	97.5
JZDP-J006-□□□ (Serial Converter for Linear Motor) ¹	540.6	230	95	1.3515 x 10 ⁻⁸	1.1840 x 10 ⁻³	1.3515 x 10 ⁻⁸	97.5
JZDP-J008-□□□ (Serial Converter for Linear Motor) ¹							

1: The Serial Converter FIT Rate includes the linear encoder because the failure of the simple SIN/COS linear scale is detected in the Yaskawa Serial Converter and in the Advanced Safety Module.

**Result**

The Advanced Safety Module with single encoder solution achieves SIL3 (IEC 61508), PLe (ISO 13849) based on CAT2 architecture.

Yaskawa Motor Encoder PFH, PFD Values With External 2nd Encoder

Motor / 1 st Encoder Type	2 nd Encoder Type	λ_{Encoder} [FIT] (worst case 1oo2 value for both encoders) ⁴	DC _{avg} Encoder [%]	PFH IEC 61508 [1/h]	PFD IEC 61508	PFH IEC 62061 [1/h]	SFF [%]
SGM7J-□□□7□□□□□□ SGM7A-□□□7□□□□□□ SGM7G-□□□7□□□□□□	JZDP-Z001 or JZDP-Z002	683.0	95	3.9056 x 10 ⁻¹⁰	3.2783 x 10 ⁻⁵	7.81295 x 10 ⁻⁹	97.5
SGM7J-□□□F□□□□□□ SGM7A-□□□F□□□□□□ SGM7G-□□□F□□□□□□	JZDP-Z001 or JZDP-Z002	592.2	95	3.3298 x 10 ⁻¹⁰	2.8095 x 10 ⁻⁵	6.6609 x 10 ⁻⁹	97.5
SGM7J-□□□6□□□□□□ SGM7A-□□□6□□□□□□ SGM7G-□□□6□□□□□□	JZDP-Z001 or JZDP-Z002	834.7	95	4.9062 x 10 ⁻¹⁰	4.0843 x 10 ⁻⁵	9.8150 x 10 ⁻⁹	97.5
SGM7□-□□□□□□□□□□	Resolver ¹	1000	95	6.0517 x 10 ⁻¹⁰	4.9947 x 10 ⁻⁵	1.2107 x 10 ⁻⁸	97.5
JZDP-H□□□ -□□□ or JZDP-J□□□ -□□□ (Serial Converter for Linear Motor) ²	JZDP-H□□□ -□□□ or JZDP-J□□□ -□□□ (Serial Converter for Linear Motor) ² ³	631.0	95	3.5737 x 10 ⁻¹⁰	3.0086 x 10 ⁻⁵	7.1489 x 10 ⁻⁹	97.5

1: Encoder worst case FIT Rate = 1000 if the value for this encoder is unknown. If the achievable PL is too low, you can perform the calculation according to the manufacturer's specifications.

2: The Serial Converter FIT Rate includes the linear encoder because the failure of the simple SIN/COS linear scale is detected in the Yaskawa Serial Converter and in the Advanced Safety Module.

3: Serial Converter any combination

4: The encoder worst case FIT value includes the FIT value for the feedback option board.

**Result**

The Advanced Safety Module with two encoders solution achieves SIL3 (IEC 61508), PLe (ISO 13849) based on CAT3 architecture.

Determination of the Safety Related Parameters According to ISO 13849

Advanced Safety Module Values

Advanced Safety Module	CPU	Per Safe DI	Per Safe DO	Per Safe AI	Per Safe AI SIL2 (temperature/current)
MTTF _d	404 years	17049 years	7552 years	5574 years	3865 years
DC _{avg}	99.9 %	99.0 %	99.0 %	99.0 %	60.0 %
SFF	99.9 %	99.5 %	99.5 %	99.5 %	80.0 %

For SGD7S-OSB01A:

$$\frac{1}{\text{MTTF}_{d \text{ total}}} = \frac{1}{\text{MTTF}_{d \text{ CPU}}} + \frac{1}{\text{MTTF}_{d \text{ Encoder}}}$$

$$\text{DC}_{\text{avg total}} = \text{DC}_{\text{avg CPU}} + \text{DC}_{\text{avg Encoder}}$$

For SGD7S-OSB02A:

$$\begin{aligned} \frac{1}{\text{MTTF}_{d \text{ total}}} = & \frac{1}{\text{MTTF}_{d \text{ SERVOPACK}}} + \frac{1}{\text{MTTF}_{d \text{ CPU}}} + n_{\text{Safe DI}} \times \frac{1}{\text{MTTF}_{d \text{ Safe DI}}} \\ & + n_{\text{Safe DO}} \times \frac{1}{\text{MTTF}_{d \text{ Safe DO}}} + n_{\text{Safe AI}} \times \frac{1}{\text{MTTF}_{d \text{ Safe AI}}} \\ & + n_{\text{Safe AI SIL2}} \times \frac{1}{\text{MTTF}_{d \text{ Safe AI SIL2}}} + \frac{1}{\text{MTTF}_{d \text{ Encoder}}} \end{aligned}$$

$$\begin{aligned} \text{DC}_{\text{avg total}} = & \frac{(\text{DC}_{\text{avg SERVOPACK}} + \text{DC}_{\text{avg CPU}} + n_{\text{Safe DI}} \times \text{DC}_{\text{avg Safe DI}} + n_{\text{Safe DO}} \times \text{DC}_{\text{avg Safe DO}}}{n_{\text{Components}}} \\ & \frac{+ n_{\text{Safe AI}} \times \text{DC}_{\text{avg Safe AI}} + n_{\text{Safe AI SIL2}} \times \text{DC}_{\text{avg Safe AI SIL2}} + \text{DC}_{\text{avg Encoder}}}{n_{\text{Components}}} \end{aligned}$$

Fig. 3: Calculation of the Safety Related Parameters According to ISO 13849

Abbreviations used:

MTTF_d: Mean Time To Failure dangerous

DC_{avg}: Average Diagnostic Coverage

n_{Safe DI}: Number of used Safe Digital Inputs

n_{Safe DO}: Number of used Safe Digital Outputs

n_{Safe AI}: Number of used Safe Analog Inputs

n_{Safe AI SIL2}: Number of used Analog Inputs Single Channel

n_{Components}: Total number of used components

3.3 SERVOPACK Installation Environment and Harmonized Standards

SERVOPACK installation environment and harmonized standards are as follows.

Installation Environment → [‘Environmental Conditions’...page 42](#)

Installation Precautions

- Mounting in a Control Panel
To prevent the temperature around the SERVOPACK from exceeding 55 °C, take into account the size of the control panel, the layout of the SERVOPACK, and the cooling method. For details, refer to chapter *SERVOPACK Installation* in the manual of the SERVOPACK.
- Mounting Near a Heating Unit
To prevent the temperature around the SERVOPACK from exceeding 55 °C, suppress radiant heat from the heating unit and temperature rise due to convection.
- Mounting Near a Vibration Source

To prevent vibration from being transmitted to the SERVOPACK, install a vibration isolator underneath the SERVOPACK.

- Mounting to a Location Exposed to Corrosive Gas

Take measures to prevent exposure to corrosive gas. Corrosive gases will not immediately affect the SERVOPACK, but will eventually cause electronic components and contactor-related devices to malfunction.

- Other Locations

Do not mount the SERVOPACK in locations subject to high temperatures, high humidity, dripping water, cutting oil, dust, iron filings, or radiation.



When storing the SERVOPACK with the power OFF, store it in an environment with the following temperature and humidity:

↪ [‘Environmental Conditions’...page 42](#)

Installation Conditions for Harmonized Standards

Harmonized Standards	↪ ‘Approvals, Directives and Standards’...page 20
Operating Conditions	Overvoltage category: III Pollution degree: 2 Protection class: IP00 (in installed condition depending on the IP class of the SERVOPACK used)
Installation Conditions	EMC Directive: Certification is required after installation in the user’s machine under the conditions outlined in ↪ ‘EMC Installation Conditions’...page 69 .

4 Checking Products

4.1 Overview

This chapter describes how to check products upon delivery.

4.2 Unpacking

Upon receiving the safety module, check to see if any shipping damages can be found!

If so:

- Immediately file a complaint to the supplier. Confirm the complaint in writing and immediately contact the representative of YASKAWA Europe GmbH who is assigned to assist you.



CAUTION

Danger due to electrostatic discharge!

The electronic components of the safety module can be damaged or totally destroyed if exposed to electrostatic discharges by being touched by hand.

In the case of SGD7S-OSB02A, this also applies if the safety I/O connector plugged onto the safety module is exposed to electrostatic discharges by hand contact.

Therefore, follow the rules and instructions for handling electrostatically sensitive components when handling the safety module.

If no damage from shipping can be found:

- Open the packaging of the device.
- Check the items included in the delivery against the bill of delivery.

The packaging consists of cardboard and plastic. Follow local regulations on disposal if you dispose of the packaging.

4.3 Checking Products on Delivery

When the Safety Module is Not Connected to the SERVOPACK

1. → Check the nameplate (ratings) to confirm that the product is the one that was ordered. For the nameplate (ratings), refer to [↪ 'Nameplate \(Ratings\) and Model Designation'...page 37](#).
2. → Mount the safety module to the SERVOPACK as described in the *Σ-7 Series Advanced Safety Module Instruction Manual*.
For the location of the nameplate, refer to [↪ 'When the Safety Module is Connected to the SERVOPACK'...page 36](#).

When the Safety Module is Connected to the SERVOPACK

Check the nameplate (ratings) ([↪ 'Nameplate \(Ratings\) and Model Designation'...page 37](#)) to confirm that the module that is mounted is the safety module.

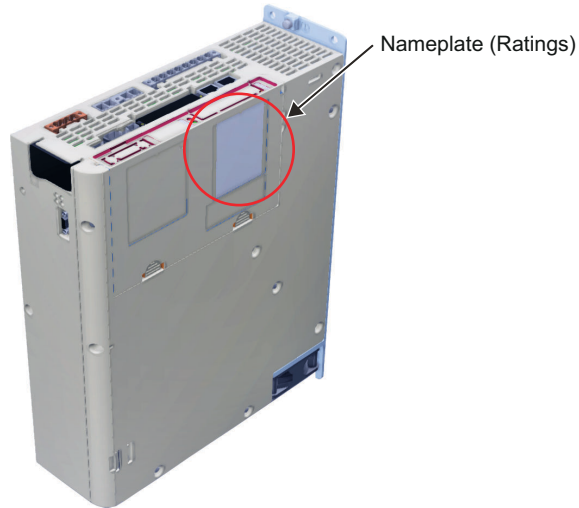

Fig. 4: Location of the Nameplate

4.4 Nameplate (Ratings) and Model Designation

Nameplate (Ratings) Example

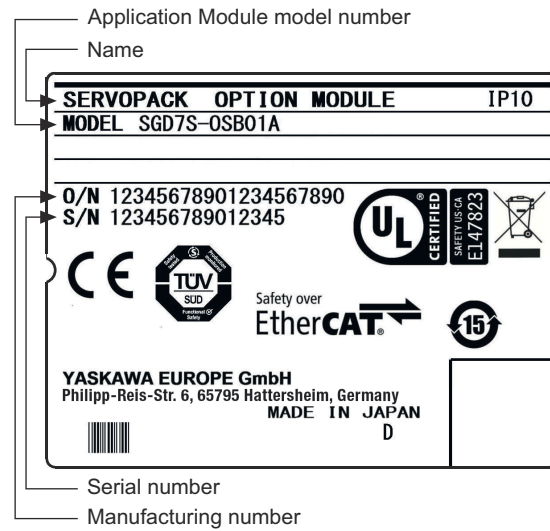

Fig. 5: Nameplate Advanced Safety Module

Model Designation

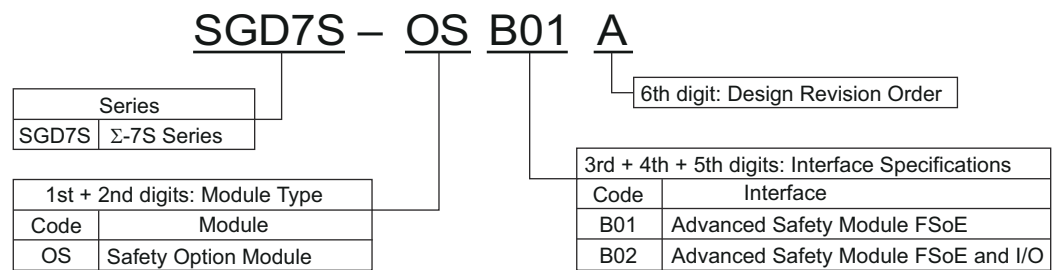

Fig. 6: Model Designation

Class	Model Code	Name
Safety Option Module	SGD7S-OSB01A	Sigma-7 Advanced Safety Module FSoE
Safety Option Module	SGD7S-OSB02A	Sigma-7 Advanced Safety Module FSoE and I/O

Allowed compatible software versions

4.5 Allowed compatible software versions

The following combinations of SERVOPACK FT91 firmware, safety module firmware and SigmaWin+ version are allowed:

SERVOPACK FT91	Advanced Safety Module	SigmaWin+	Communication platform *	ASM7 Parameter Editor	ASM7 Service Tool
v8.22	v008	v7.45 or higher	v1.00.5300 or higher	v1.1.2.4	v1.0.0.2

* only to be considered if SigmaWin+ is not installed

5 Specifications

5.1 Overview

This chapter gives an overview and describes the specifications of the safety module.

5.2 General

Machine movements represent a major source of hazard for operators and staff members carrying out maintenance tasks. The potential dangers posed by these movements affect the operational safety of machines and installations and have to be included in safety considerations.

The safety module is part of a system to provide the user with up to 16 safety functions for the Sigma-7 servo drives. The additional built-in "STO" (Safe Torque Off) function of the SERVOPACK does not require the usage of the safety module. The user can attach the safety module to applicable Sigma-7 SERVOPACKs (SGD7S-□□□DA0□8□□F91).

This operating manual covers the safety module and the PC tool to configure the safety module (Advanced Safety Module Parameter Editor) → '*Advanced Safety Module Parameter Editor*'...page 124. For information on downloading, installing and activating the Advanced Safety Module Parameter Editor, please refer to the corresponding product documentation:

Name	Manual number
Advanced Safety Module Parameter Editor for Sigma-7 SERVOPACK SGD7S-□□□DA0□8□□F91, 400 V Quick Installation Guide	TOEP YEUS07S 02

The Sigma-7 SERVOPACKs (SGD7S-□□□DA0□8□□F91) are described in the corresponding product documentation:

Name	Manual number
Σ-7-Series AC Servo Drive Σ-7S SERVOPACK with 400V-Input Power and EtherCAT (CoE) Communications References FT/EX Specification for Advanced Safety Module Product Manual	SIEP S800002 30

All documentation can be found on the YASKAWA website <http://www.yaskawa.eu.com> or contact a YASKAWA representative.

5.3 Interaction With Other System Components

To activate and monitor the configured safety functions, a Safety PLC can be used. Activation can be done either via FSoE or by using the physical I/O terminals of the safety module. Passive parts (e.g. pushbutton) can be used to activate.

5.4 Safety Module Variants

The user can choose between two different safety module variants:

- SGD7S-OSB01A provides an FSoE interface for activating the configured safety functions.
- SGD7S-OSB02A provides an FSoE interface like SGD7S-OSB01A and contains additional physical I/O terminals with digital and analog I/Os. An additional 24 V power supply is required.



An extension of the SGD7S-OSB01A variant with the I/O PCB is not possible.

5.5 Basic Specification of the Advanced Safety Module

The following table lists the general specifications of the safety module:

Item	Specifications	Remark
Applicable SERVOPACK	SGD7S-□□□DA0□8□□F91	↪ 'Device Combinations' ...page 310
Applicable Servo Motors	All Sigma-7 rotary motors that are supported by SGD7S-□□□DA0□8□□F91. Any model of linear servomotor that is supported by SGD7S-□□□DA0□8□□F91.	
Power Supply Method	↪ 'Electrical Specifications'...page 49	
Number of Safety Function Slots	10 10 out of up to 16 safety functions can work (be activated) in parallel	
Safety Functions Slots	Inputs: 1 or 2 channels or over FSoE interface Outputs: 1 or 2 channels or over FSoE interface	1oo2 configuration
Stopping Methods	<ul style="list-style-type: none"> ■ Safe Torque Off (STO) ■ Safe Stop 1 deceleration controlled (SS1-r) ■ Safe Stop 1 time controlled (SS1-t) ■ Safe Stop 2 deceleration controlled (SS2-r) ■ Safe Stop 2 time controlled (SS2-t) 	Stopping methods which are provided by IEC 61800-5-2
Proof Test Interval	20 years	

5.6 Typical Reaction Time

The system's reaction time is the time that is required to transmit information from the sensor/switch to the servomotor, if the overall system is working without error in normal operation.

Reaction Time when Activating via the Digital Input

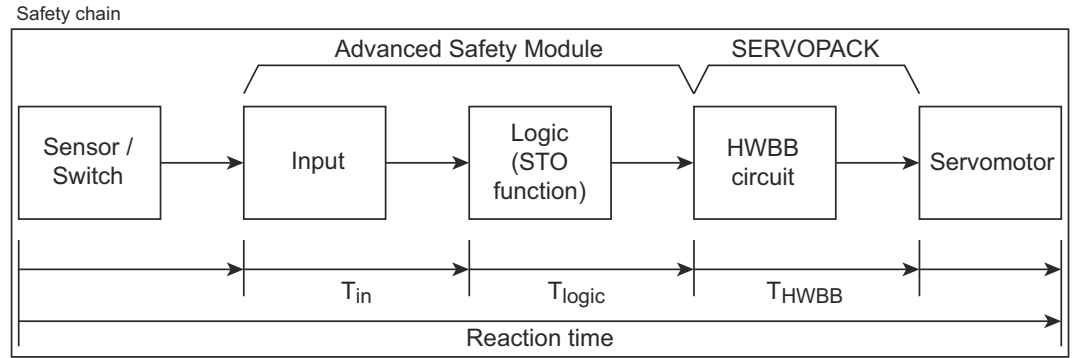

Fig. 7: Reaction Time When Activating Via the Digital Input

The reaction time of the sensor / switch until the signal is provided at the interface is typically supplied by the sensor / switch manufacturer.

Reaction Time of the Advanced Safety Module

Definition	Description
T_{in}	Reaction time of the digital input. T_{in} includes the configurable filter time (0 to 1000 ms).
T_{logic}	This is the time from the output of the STO activation signal from the input section to the output of the request signal to the HWBB circuit.

Reaction Time (Advanced Safety Module) = $T_{in} + T_{logic}$ = configurable filter time + 7 ms.

Reaction Time of the SERVOPACK

Definition	Description
T_{HWBB}	This is the time required to switch off the motor power from the demand signal. It is 3 ms for the applicable SERVOPACK.



The worst-case reaction time is the maximum time required to switch off the servomotor in the case of an error.

Reaction Time when Activating via FSoE

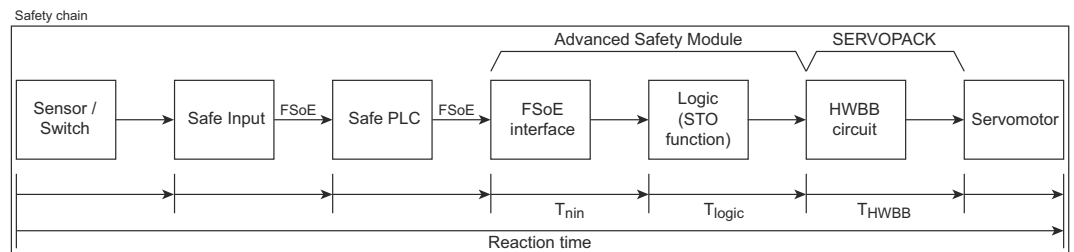

Fig. 8: Reaction Time When Activating via FSoE

Reaction Time of the Advanced Safety Module

Definition	Description
T_{nin}	FSoE worst case processing time in the Advanced Safety Module. The minimum time of T_{nin} is 30 ms (default value of the configurable watchdog time).

Environmental Conditions

Definition	Description
T_{logic}	This is the time from the output of the STO activation signal from the FSoE interface section to the output of the request signal to the HWBB circuit.

Worst Case Reaction Time (Advanced Safety Module) = $T_{nin} + T_{logic}$ = Watchdog time + 7 ms = 37 ms

Safety Response Time (with FSoE): 37 ms



The worst-case reaction time is the maximum time required to switch off the servomotor in the case of an error.

Reaction Time of the SERVOPACK

Definition	Description
T_{HWBB}	This is the time required to switch off the motor power from the demand signal. It is 3 ms for the applicable SERVOPACK.

5.7 Environmental Conditions

Ambient air temperature	0 °C to +55 °C
Ambient air humidity	95 % relative humidity max. (with no freezing or condensation)
Storage temperature	-20 °C to +85 °C
Storage humidity	95 % relative humidity max. (with no freezing or condensation)
Vibration resistance	4.9 m/s ² (10 up to max. 55 Hz)
Shock resistance	19.6 m/s ²
Degree of protection	IP00 (in installed condition depending on the IP class of the SERVOPACK used)
Pollution degree	2 <ul style="list-style-type: none"> ■ Must be no corrosive or flammable gases. ■ Must be no exposure to water, oil, or chemicals. ■ Must be no dust, salts, or iron dust.
Altitude	2,000 m or less.
Others	Do not use the safety module in the following locations: Locations subject to static electricity noise, strong electromagnetic/ magnetic fields, or radioactivity
Standards	CE, UL, cUL, RoHS, REACH

5.8 Board Outline

Sigma-7 Advanced Safety Module SGD7S-OSB01A

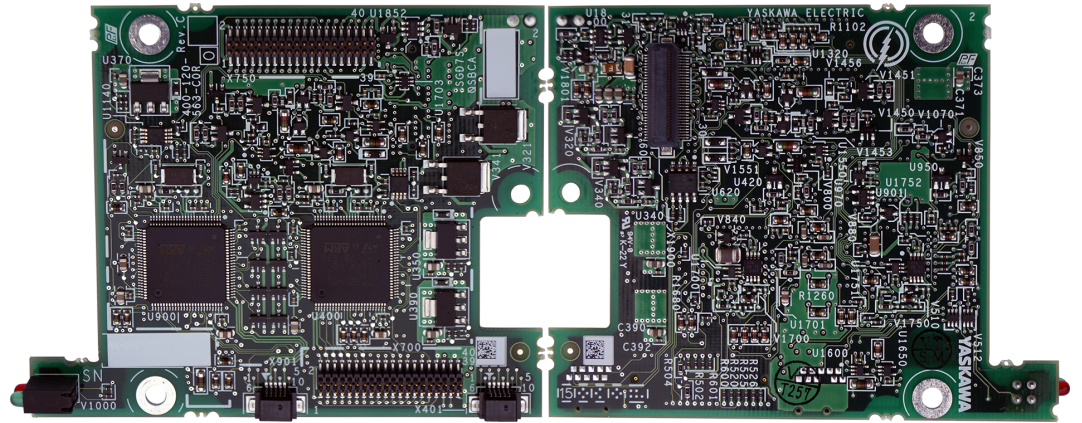

Fig. 9: SGD7S-OSB01A (Frontside / Backside)

Sigma-7 Advanced Safety Module SGD7S-OSB02A FSoE and I/O

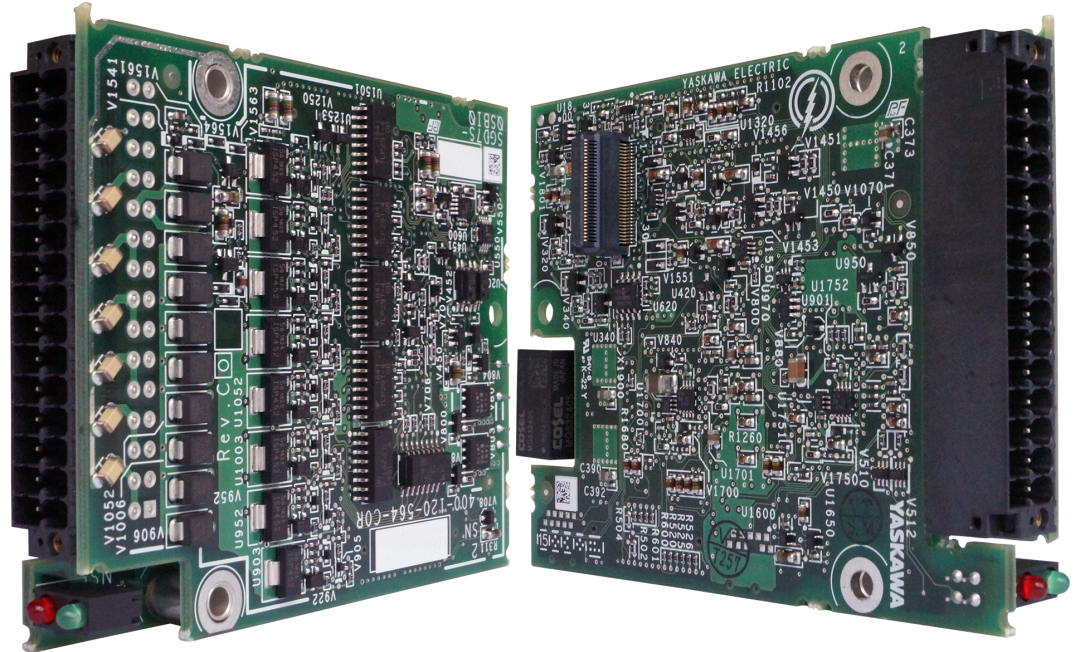

Fig. 10: SGD7S-OSB02A - Perspective View of Both Boards (Frontside / Backside)

6 Wiring and Connection

6.1 Overview

This chapter describes with examples how to configure a system with the safety module and how to connect the I/O signals. Details of the main circuit, encoders and regenerative resistors can be found in the manual for the SERVOPACK used. For further information on the safe and stable use of the servo system, refer to the relevant safety instructions in the manuals.

6.2 SERVOPACK Installation

For a detailed description of the installation, see chapter *SERVOPACK Installation* in the manual of the SERVOPACK.

Safety Precautions

A detailed description of the safety precautions to be taken during installation, which must be observed, can be found in the SERVOPACK manual in the section on safety precautions.

6.3 Safety Precautions

Wiring Precautions



DANGER

- Do not change any wiring while power is being supplied. There is a risk of electric shock or injury.



WARNING

- Wiring and inspections must only be carried out by qualified engineers. There is a risk of electric shock or product failure.
- Check all wiring and power supplies carefully. Incorrect wiring or incorrect voltage application to the output circuits may cause short-circuit failures. If a short-circuit failure occurs as a result of any of these causes, the holding brake may not work. This could damage the machine or cause an accident that may result in death or injury.
- Connect the power supplies to the specified SERVOPACK terminals. Detailed information on this can be found in the manual *SIEP S800002 30 (Σ-7-Series AC Servo Drive Σ-7S SERVOPACK with 400V-Input Power and EtherCAT (CoE) Communications References FT/EX Specification for Advanced Safety Module)*. There is a risk of failure or fire.

**CAUTION**

- Wait for six minutes after turning OFF the power supply and then make sure that the CHARGE indicator is not lit before starting wiring or inspection work. Do not touch the power supply terminals while the CHARGE lamp is lit after turning OFF the power supply because high voltage may still remain in the SERVOPACK.
There is a risk of electric shock.
- Observe the precautions and instructions for wiring and trial operation precisely as described in this document.
Failures caused by incorrect wiring or incorrect voltage application in the brake circuit may cause the SERVOPACK to fail, damage the equipment, or cause an accident resulting in death or injury.
- Check the wiring to be sure it has been performed correctly.
Connectors and pin layouts are sometimes different for different models. Always confirm the pin layouts in technical documents for your model before operation.
There is a risk of failure or malfunction.
- Connect wires to power supply terminals and motor connection terminals securely with the specified methods and tightening torque.
Insufficient tightening may cause wires and terminal blocks to generate heat due to faulty contact, possibly resulting in fire.
- Use shielded twisted-pair cables or screened unshielded multi-twisted-pair cables for I/O signal cables and encoder cables.
- Observe the following precautions when wiring the SERVOPACK's main circuit terminals.
 - Turn ON the power supply to the SERVOPACK only after all wiring, including the main circuit terminals, has been completed.
 - If a connector is used for the main circuit terminals, remove the main circuit connector from the SERVOPACK before you wire it.
 - Insert only one wire per insertion hole in the main circuit terminals.
 - When you insert a wire, make sure that the conductor wire (e.g., whiskers) does not come into contact with adjacent wires.
- Install molded-case circuit breakers and other safety measures to provide protection against short circuits in external wiring.
There is a risk of fire or failure.

**NOTICE**

- Whenever possible, use the cables specified by Yaskawa.
If you use any other cables, confirm the rated current and application environment of your model and use the wiring materials specified by Yaskawa or equivalent materials.
- Securely tighten cable connector screws and lock mechanisms.
Insufficient tightening may result in cable connectors falling off during operation.
- Do not bundle power lines (e.g. the main circuit cable) and low current lines (e.g., the I/O signal cables or encoder cables) together or run them through the same duct. If you do not place power lines and low current lines in separate ducts, separate them by at least 30 cm.
If the cables are too close to each other, malfunctions may occur due to noise affecting the low current lines.
- Install a battery at either the host controller or on the encoder cable.
If you install batteries both at the host controller and on the encoder cable at the same time, you will create a loop circuit between the batteries, resulting in a risk of damage or burning.
- When connecting a battery, connect the polarity correctly.
There is a risk of battery rupture or encoder failure.
- If you use an external regenerative resistor or an external dynamic brake resistor, use cable ties, clamps, or other means to secure the resistor so that the connectors or terminal blocks inside the SERVOPACK will not be affected even if the resistor is subjected to vibration or shock.
There is a risk of SERVOPACK damage.

6.4 System Configuration Diagram

Overview

The safety module is an optional module that can be connected to SGD7S-□□□DA0□8□□F91 SERVOPACKs. It supports Basic Safety Functions and Advanced Safety Functions → [‘Safety Features’...page 86](#).

The safety module uses the stop functions defined by IEC61800-5-2, which is achieved by using the HWBB function installed in the SERVOPACK.

An example of system configuration is shown below.

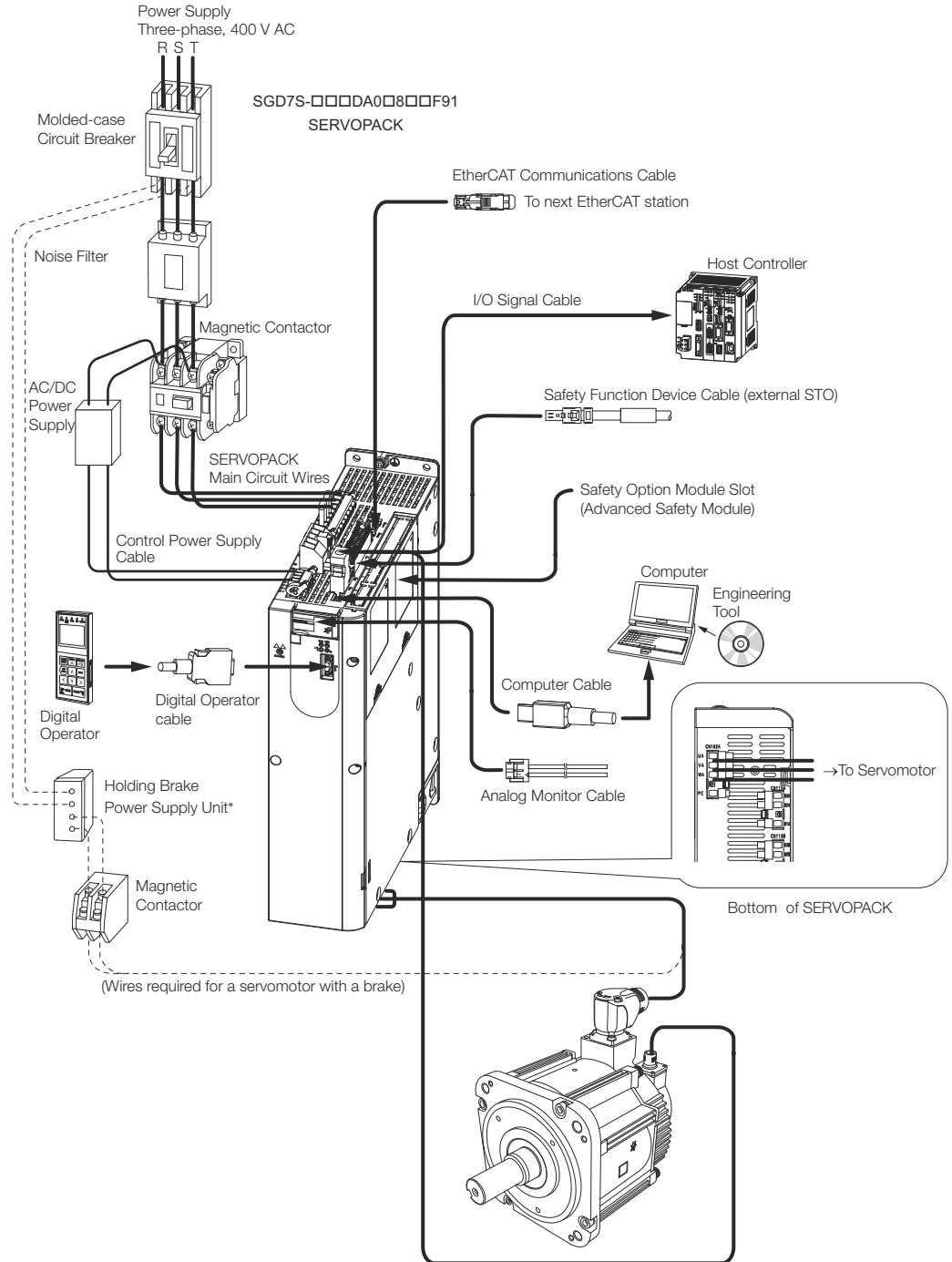

Fig. 11: Sigma-7 SGD7S-□□□□DA0□8□□F91 400 V SERVOPACK System Configuration Diagram

* The power supply for the holding brake is not provided by Yaskawa. Select a power supply based on the holding brake specifications.
 If you use a 24 V brake, install a separate power supply for the 24 V DC power supply from other power supplies, such as the one for the I/O signals of the CN1 connector.
 If the power supply is shared, the I/O signals may malfunction.

Wiring Concept

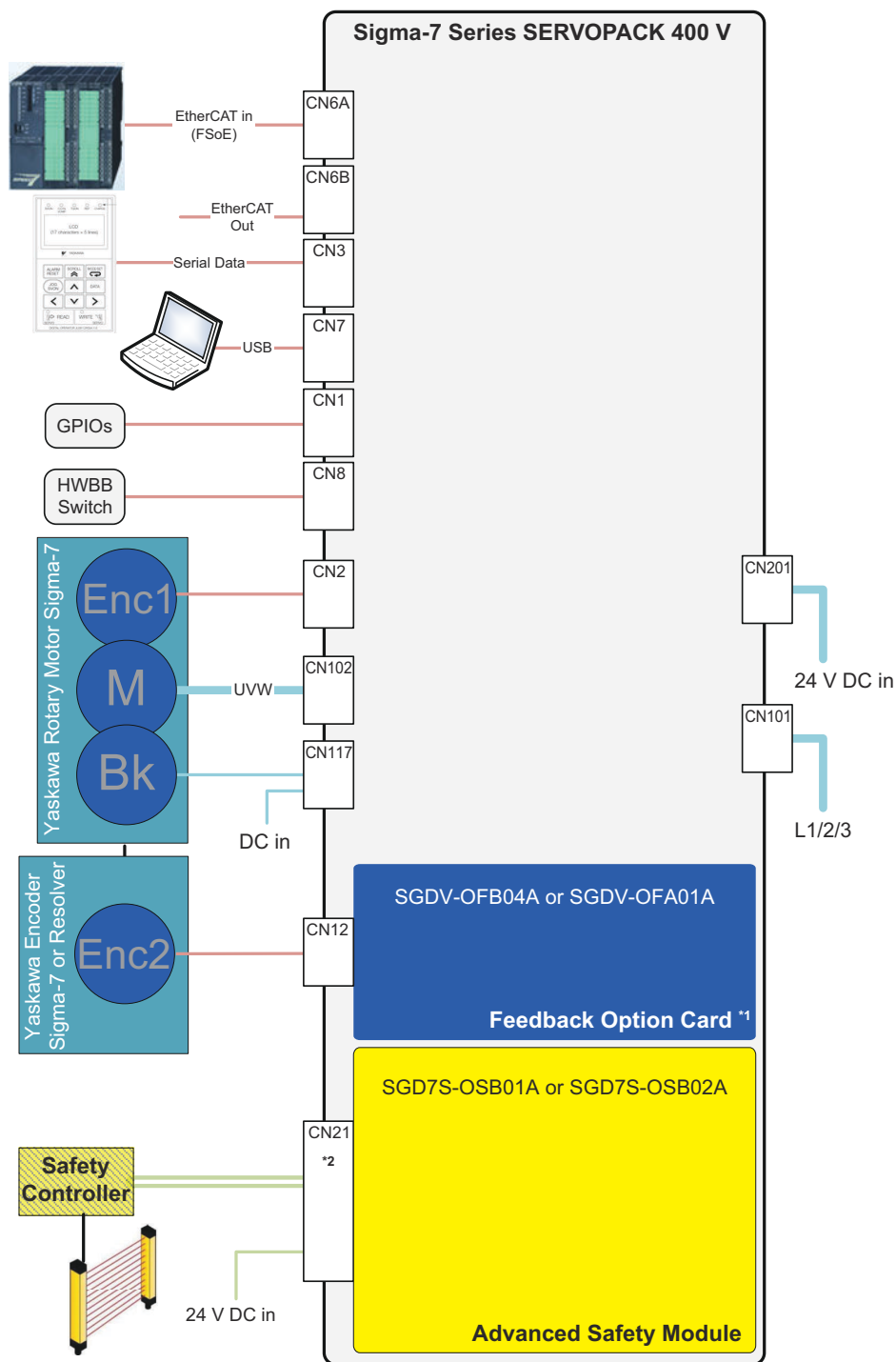

Fig. 12: Advanced Safety Module Wiring Concept Rotary Motor

*1 Feedback Option Card type depends on connected device:

- Yaskawa Encoder Sigma-7: SGDV-OFA01A
- Resolver: SGDV-OFB04A

*2 Connector CN21 is only available on SGD7S-OSB02A

Detailed information on the wiring of linear motors can be found in [↪ 'For Linear Servo-motors'...page 72.](#)

Safe Performance Depending on Whether a Safety Function Device (Or the Safety Jumper Connector) Is Connected to CN8

- If the Safety Jumper Connector is connected to CN8, this enables pure operation of the Advanced Safety Module (STO only possible via the Advanced Safety Module).
- If you do not connect a safety function device, leave the Safety Jumper Connector connected to the connector for the safety function device (CN8). If the SERVOPACK is used without the Safety Jumper Connector connected to CN8, no current will be supplied to the Servomotor and no motor torque will be output. In this case, **Hbb** will be displayed on the Digital Operator, i. e. STO is permanently on at the SERVOPACK.
- If a safety function device is connected to CN8, STO can be triggered directly on the SERVOPACK. In parallel, the STO function of the Advanced Safety Module (if parameterised) is also available.

Use the following procedure to connect a safety function device.

1. ➔ Remove the Safety Jumper Connector from the connector for the safety function device (CN8).

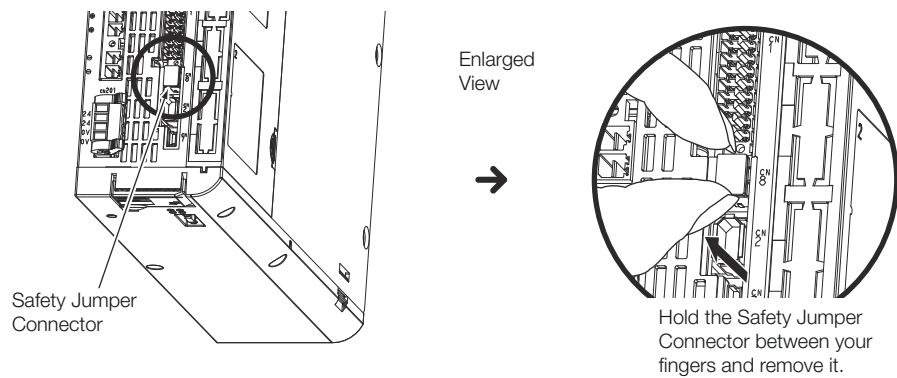

Fig. 13: Removing the Safety Jumper Connector CN8

2. ➔ Connect the safety function device to the connector for the safety function device (CN8).

6.5 Electrical Specifications

6.5.1 Power Supply Specification

Power Supply Specification

Two power supplies are required for the safety module:

- 5 V DC: supplied internally from the control power supply of the SERVOPACK
- 24 V DC: must be provided externally (only required for SGD7S-OSB02A)

External Power Supply Specifications (SGD7S-OSB02A only)

Item	Code	Min	Max	Unit	Remark
Power Supply Voltage	V _{CC}	19.20	30.00	V	External power supply
Current Consumption	I _{CC}	50	1100	mA	Minimum current of the safety module (without any input and output) Maximum current of the safety module (with all outputs in use)

6.5.2 I/O Signal Connections

This section describes the names and functions of the I/O connector (CN21) for the safety functions.

Connector	Features
30 Pin IO-Connector (CN21) (SGD7S-OSB02A only)	<p>The I/O Connector consists of 7 Ports:</p> <ul style="list-style-type: none"> ■ Port A - Safe Digital Input, Safe Digital Output or Non-safe EDM Signal Output ■ Port B - Safe Digital Input, Safe Digital Output or Non-safe EDM Signal Output ■ Port C - Safe Digital Input, Safe Digital Output or Non-safe EDM Signal Output ■ Port D - Safe Digital Input, Safe Digital Output or Non-safe EDM Signal Output ■ Port E - Safe Digital Input ■ Port F - Safe Digital Input or Safe Analog Input (0-10 V) ■ Port G1 - Current Input (4-20 mA) ■ Port G2 - RTD Input (PT1000)

Terminal Layout

The safety module is equipped with a 30 pin connector (two parallel row arrangement) with the following pin assignment.

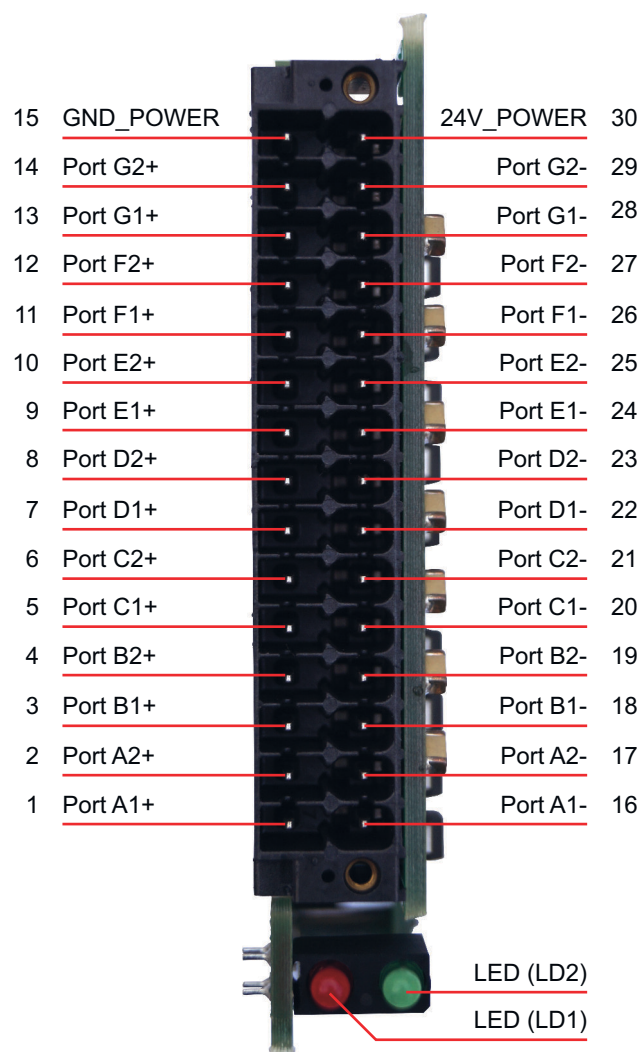

Fig. 14: Pin Arrangement I/O Connector CN21 (Plug)

I/O Connector (CN21)

Pin	Signal name	Description	Pin	Signal name	Description
15	GND_POWER	Ext. 24 V Power Supply	30	24V_POWER	Ext. 24 V Power Supply
14	Port G2+	RTD Input (PT1000)	29	Port G2-	RTD Input (PT1000)
13	Port G1+	Current Input (4-20 mA)	28	Port G1-	Current Input (4-20 mA)
12	Port F2+	Digital Input / Analog Input (0-10 V)	27	Port F2-	Digital Input / Analog Input (0-10 V)
11	Port F1+	Digital Input / Analog Input (0-10 V)	26	Port F1-	Digital Input / Analog Input (0-10 V)
10	Port E2+	Digital Input	25	Port E2-	Digital Input
9	Port E1+	Digital Input	24	Port E1-	Digital Input
8	Port D2+	Digital Input / Output	23	Port D2-	Digital Input / Output
7	Port D1+	Digital Input / Output	22	Port D1-	Digital Input / Output
6	Port C2+	Digital Input / Output	21	Port C2-	Digital Input / Output
5	Port C1+	Digital Input / Output	20	Port C1-	Digital Input / Output
4	Port B2+	Digital Input / Output	19	Port B2-	Digital Input / Output
3	Port B1+	Digital Input / Output	18	Port B1-	Digital Input / Output
2	Port A2+	Digital Input / Output	17	Port A2-	Digital Input / Output
1	Port A1+	Digital Input / Output	16	Port A1-	Digital Input / Output



The (-) connections of the individual channels of ports A to F are interconnected in the safety module:

- A1 (-) with A2 (-)
- B1 (-) with B2 (-)
- C1 (-) with C2 (-)
- D1 (-) with D2 (-)
- E1 (-) with E2 (-)
- F1 (-) with F2 (-)

Terminal Configuration

The following table describes the assignment options of ports A to F as well as G1 and G2, which can be configured as physical inputs or outputs at I/O Connector CN21, see [↔ 'Terminal Layout'...page 50](#). The table also specifies whether the respective combination results in a Safe Port or not.

I/O Port Function Types

Safe	Function Type	A	B	C	D	E	F	G1	G2
2-channel	Digital Input	●	●	●	●	●	●	–	–
2-channel	Digital Input Test Pulse A	–	●	●	●	●	●	–	–
2-channel	Digital Input Test Pulse B	●	–	●	●	●	●	–	–
2-channel	Analog Input (0-10V)	–	–	–	–	–	●	–	–
1-channel	Analog Input (4-20mA)	–	–	–	–	–	–	●	–
1-channel	Analog Input (PT1000)	–	–	–	–	–	–	–	●

Safe	Function Type	A	B	C	D	E	F	G1	G2
2-channel	Digital Output	•	•	•	•	–	–	–	–
no	Digital Output EDM	•	•	•	•	–	–	–	–
2-channel	Digital Output Test Pulse	•	•	–	–	–	–	–	–

• = Available

– = Not available

6.5.3 Digital Input Characteristics and Connections

There are 6 ports (A – F) that can be configured as a safe digital input.

Electrical Characteristics of a Digital Input Channel According to DIN EN 61131-2

Parameter	Min	Max	Unit
0-State (voltage)	-3	5	V
1-State (voltage)	11	30	V
Intermediate level (voltage)	5	11	V
0-State (current)	-	15	mA
1-State (current)	2	15	mA
Intermediate level (current)	1,5	15	mA

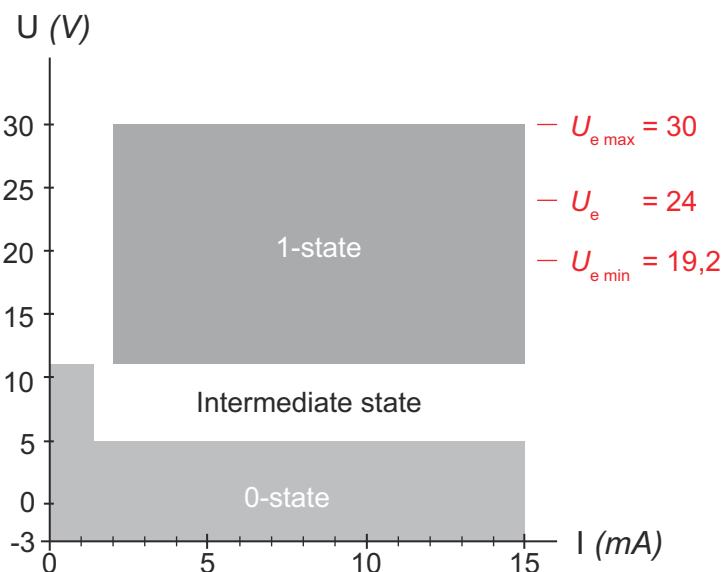

Fig. 15: U-I Operation Regions of Current-Sinking Inputs

U_e , $U_{e\max}$ and $U_{e\min}$ are the rated voltage and its limits for the external power supply voltage

Cable Lengths for the Connection of Digital Signals

The maximum cable length is based on the length that results in acceptable resistance and noise immunity. It is recommended to keep these cables as short as possible and to choose a maximum length of 100 m.

Digital Input Configuration

The digital input ports can be configured as

- Safe Digital Input
- Safe Digital Input Test Pulse A (refer to → ‘Digital Output Configuration’...page 57 for wiring)
- Safe Digital Input Test Pulse B (refer to → ‘Digital Output Configuration’...page 57 for wiring)

In accordance with the selected configuration above, the input channel wiring will be as shown in the figures below.

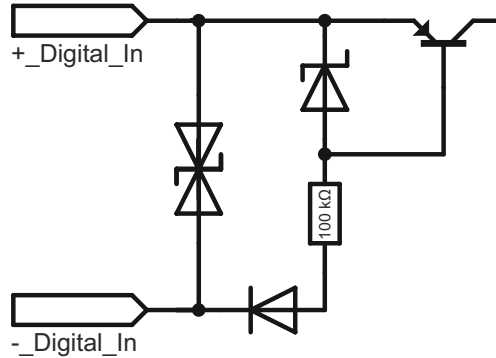

Fig. 16: Internal Circuit Diagram

The dual-channel wiring of a Safe Digital Input is shown in the following figure.

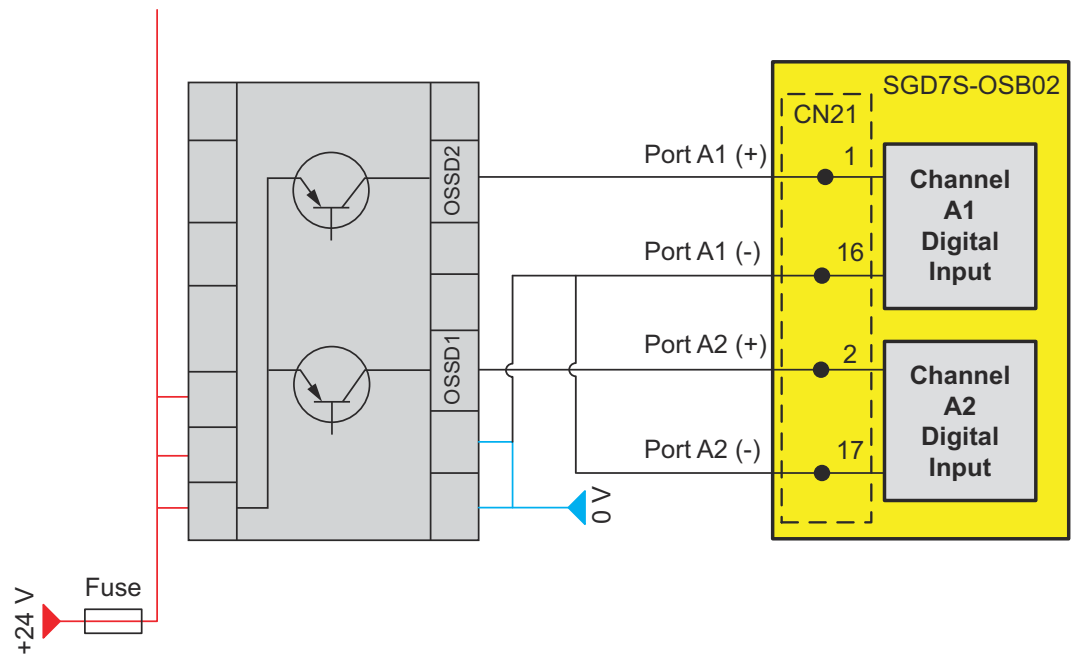

Fig. 17: Safe Digital Input Wiring Example

6.5.4 Analog Input Characteristics and Connections

There are 2 ports (F, G) that can be configured as a (safe) analog input.

Signal Name	Signal Range	Remarks
Port F	0 - 10 V	Configurable as Safe Analog Input or Safe Digital Input
Port G1	4 - 20 mA	SIL2 Analog Input
Port G2	PT1000	SIL2 Analog Input for for RTD (PT1000)

Cable Lengths for the Connection of Analog Signals

The maximum cable length is based on the length that results in acceptable resistance and noise immunity. It is recommended to keep these cables as short as possible and to choose a maximum length of 5 m.

Shielding and Grounding of the Cables

Use shielded, properly grounded cables for all analog inputs and communication connections. If you do not use shielded cable for these connections, electromagnetic interference may cause signal degradation.

The grounding should be performed as described in the SERVOPACK manual:

Name	Manual number
Σ-7-Series AC Servo Drive Σ-7S SERVOPACK with 400V-Input Power and EtherCAT (CoE) Communications References FT/EX Specification for Advanced Safety Module Product Manual	SIEP S800002 30



WARNING

Unintended equipment operation

- Use shielded cables for all analog I/O signals.
- Ground cable shields for all analog I/O signals at a single point¹.
- Route communications and I/O cables separately from power cables.

Failure to follow these instructions can result in death, serious injury, or equipment damage.

¹ Multipoint grounding is permissible if connections are made to an equipotential ground plane dimensioned to help avoid cable shield damage in the event of power system short-circuit currents.



WARNING

Unintended equipment operation

Do not connect wires to unused terminals and/or terminals indicated as “No Connection (N.C.)”.

Failure to follow these instructions can result in death, serious injury, or equipment damage.

For analog sensors, the resistance of the connecting cable should be taken into account, otherwise measurement error will occur. The values should be checked with the SigmaWin+ monitors for voltage, current and temperature (Un0C2, Un0C3, Un0C4, Un0C5 - [↪ ‘Monitoring Analog Inputs’...page 63](#)).

Analog Input Configuration

The SIL3 analog input port F can be configured as

- Port F: 0-10 V interface

The SIL2 analog input port G can be activated to be used as

- Port G1: 4-20 mA interface
- Port G2: PT1000 interface

In accordance with the selected configuration above, the input channel wiring will be as shown in the figures below.

Analog Input (0-10 V)

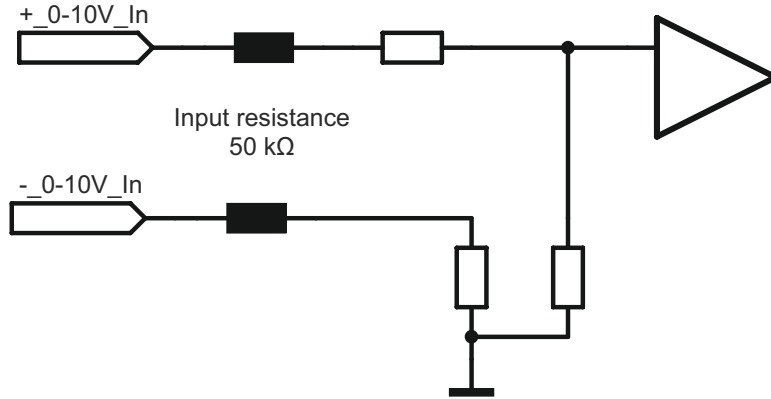

Fig. 18: Internal Circuit Diagram Analog Input (0-10 V)

The dual-channel wiring of the Safe Analog Input 0-10 V interface is shown in the following figure.

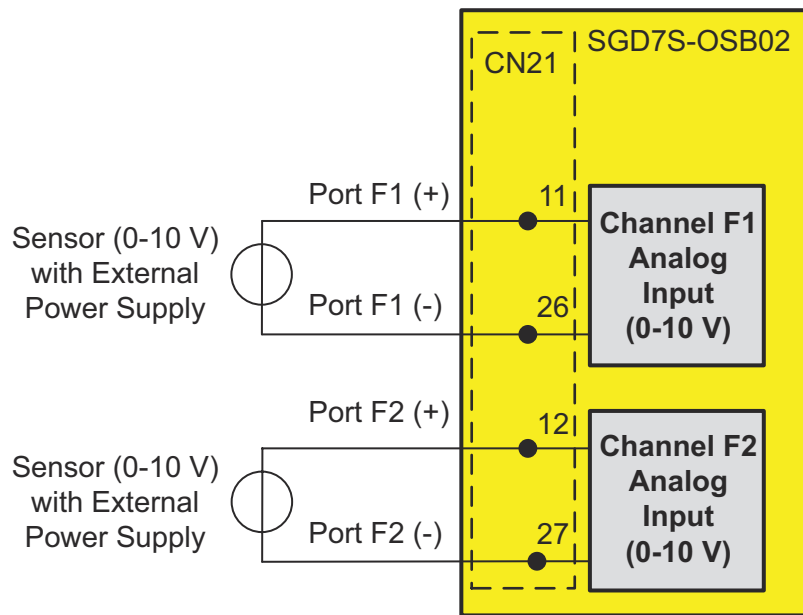

Fig. 19: Analog Input (0-10 V) Wiring Example



As shown in the previous figure, the analog ports F1, F2 must each be supplied individually and the outputs must be galvanically isolated.



After wiring, check that the analog input signals are arriving as you expect. In addition to using an oscilloscope, using the oscilloscope function in the SigmaWin+ engineering tool is another option. Refer to section → 'Monitoring Analog Inputs'...page 63 how to monitor the input signals.

Analog Input (4-20 mA, PT1000)

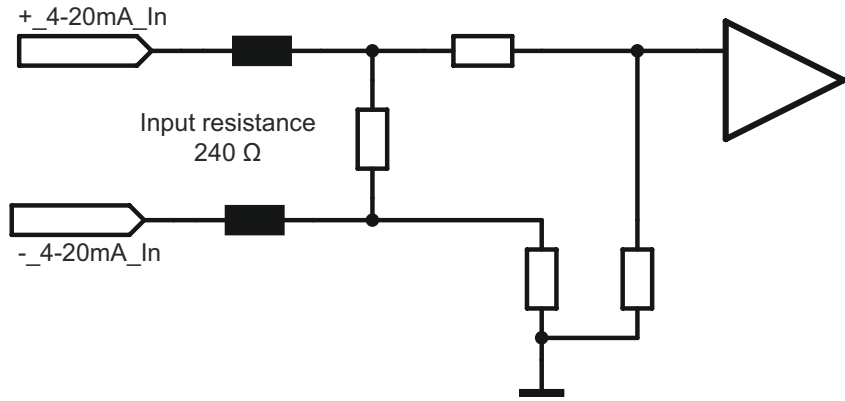

Fig. 20: Internal Circuit Diagram Port Analog Input (4-20 mA)

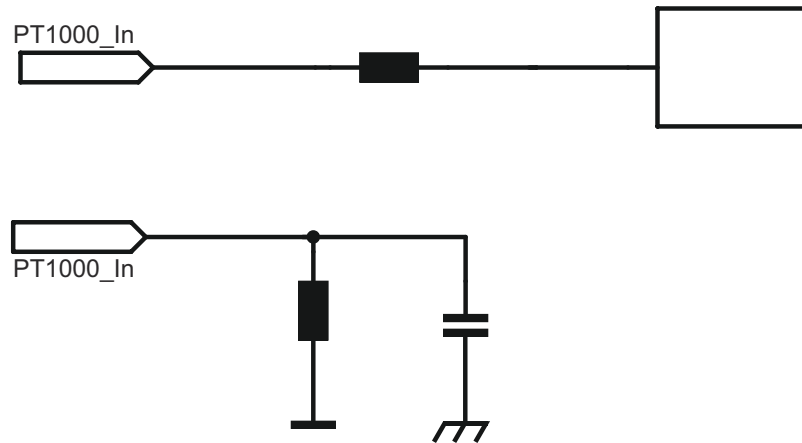

Fig. 21: Internal Circuit Diagram Analog Input (PT1000)

The single-channel wiring of the Analog Input 4-20 mA and PT1000 interface is shown in the following figure.

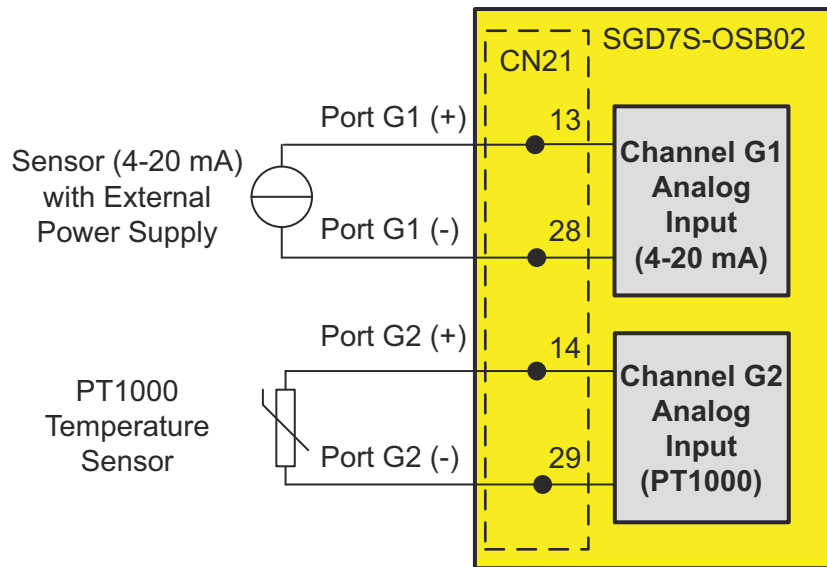

Fig. 22: Analog Input (4-20mA) & PT1000 Wiring Example



As shown in the previous figure, the analog port G1 must be supplied individually and the outputs must be galvanically isolated.



After wiring, please check whether the analog input signals arrive as you expect them to. In addition to using an oscilloscope, using the oscilloscope function in the SigmaWin+ engineering tool is another option. Refer to section → 'Monitoring Analog Inputs'...page 63 how to monitor the input signals.

6.5.5 Digital Output Characteristics and Connections

There are 4 ports (A – D) that can be configured as a (safe) digital output.

Electrical Characteristics of a Digital Output Channel

Item	Characteristic	Remark
Maximum Allowable Voltage	30 V	
Maximum Current	100 mA	typical value
Minimum Current	≥ 2 mA	

Cable Lengths for the Connection of Digital Signals

The maximum cable length is based on the length that results in acceptable resistance and noise immunity. It is recommended to keep these cables as short as possible and to choose a maximum length of 100 m.

Digital Output Configuration

The digital output ports can be configured as

- Non-safe EDM Signal Output
- Safe Digital Output
- Safe Digital Output Test Pulse A (for testing safe input channels)
- Safe Digital Output Test Pulse B (for testing safe input channels)

In accordance with the selected configuration above, the output channel wiring will be as shown in the figures below.

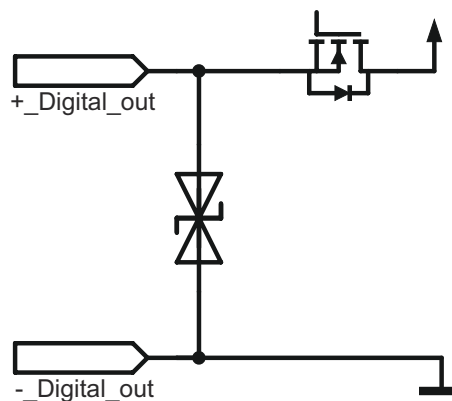

Fig. 23: Internal Circuit Diagram

The wiring of non-safe EDM Signal Output is shown in the following figure. Both channels are independent from each other.

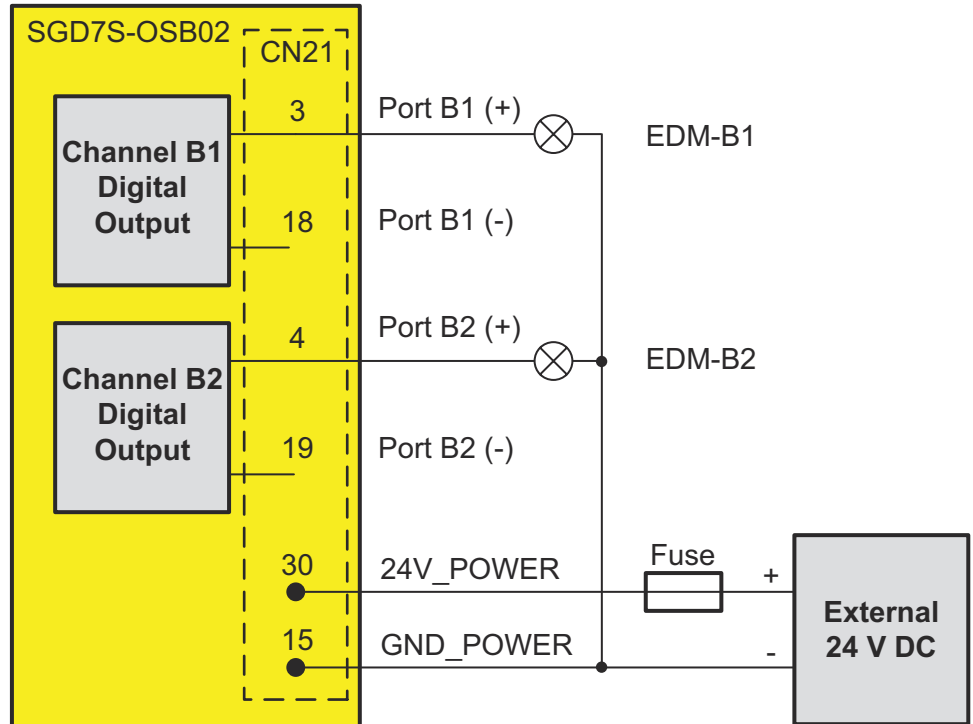

Fig. 24: Digital Output Wiring Example

The dual-channel wiring of a Safe Digital Output is shown in the following figure.

Safety device like safety controller or other Advanced Safety Module

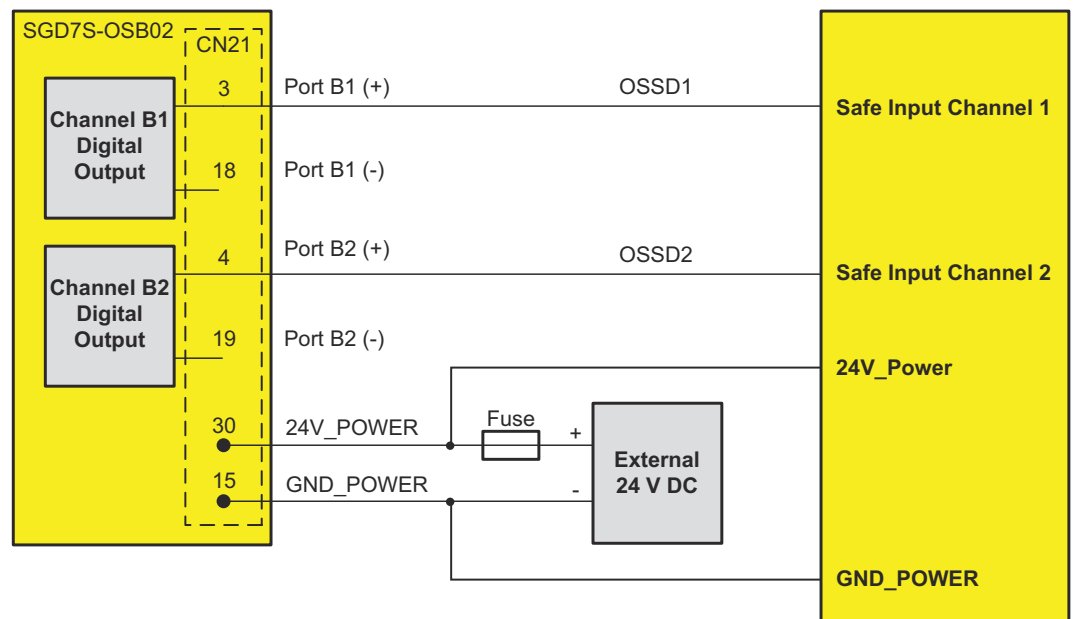

Fig. 25: Safe Digital Output Wiring Example

The dual-channel wiring of a Safe Digital Output Test Pulse (A, B) is shown in the following figure.

Overall, two safe ports are needed to establish the wiring. For a Safe Digital Output Test Pulse (A, B) a second safe port configured as dual-channel Safe Digital Input Test Pulse (A, B) is required. In the following example safe port A is configured as Safe Digital Output Test Pulse A. The signal level ON (24 V) provided by this Safe Digital Output contains test pulses that are checked by safe port C configured as Safe Digital Input Test Pulse A.

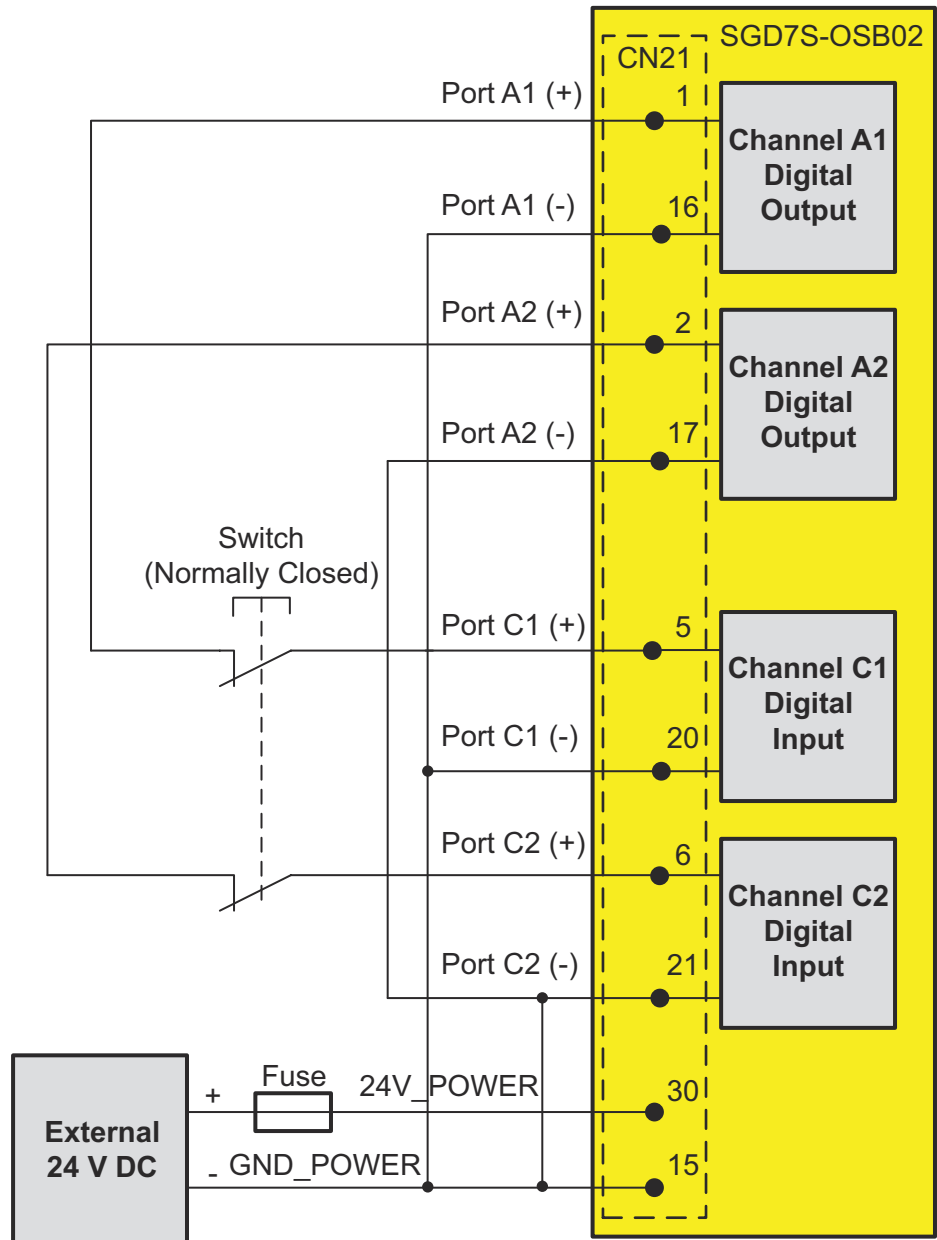

Fig. 26: Safe Digital Input Test Pulse (A, B) Wiring Example

6.5.5.1 Digital Outputs

The four available digital output ports A to D deliver not a continuous signal at signal level 24 V (ON), but are interrupted by a double test pulse. The double test pulse does not depend on the digital output configuration, i.e. it is available on the Safe Digital Outputs, Safe Digital Output Test Pulse (A, B) and EDM Signal Outputs.



The double test pulse is generated by a watchdog connected to a sum switch and is required for internal tests of the physical I/O interface. The double test pulses cannot be deactivated. Please check the input filter time of the connected hardware (e.g. safety controller).

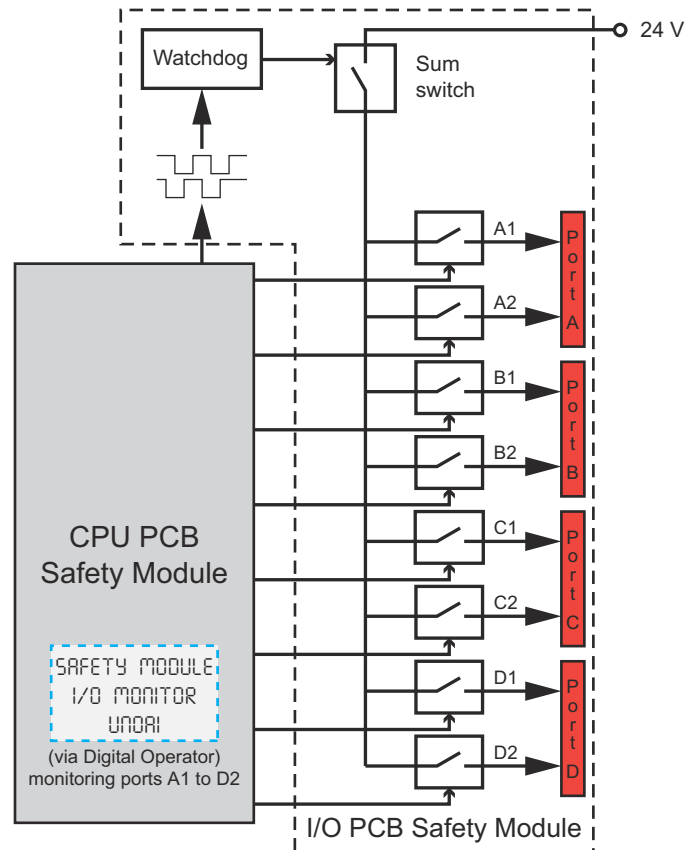

Fig. 27: Sum Switch on I/O PCB

The double test pulse on the digital output ports is 2 ms each with approx. 100 ms delay. Depending on the configuration of the digital outputs, the time between two double test pulses varies in a range between 1000 ms to 5000 ms.

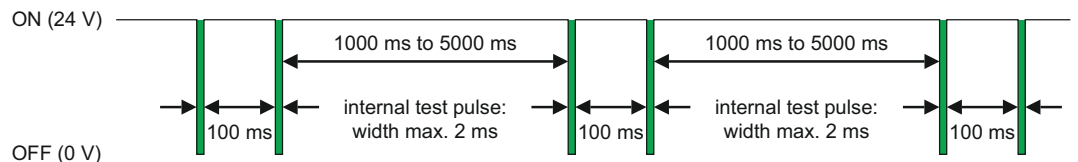

Fig. 28: Test Pulses on Digital Outputs

6.5.5.2 EDM Signal Output

For the digital output ports A to D configured as EDM Signal Output, the continuous signal level ON (24 V) is interrupted by the double test pulse.



The EDM signal on the safety module has internal test pulses, but the EDM signal on the SERVOPACK does not have them.

Safe (HWBB) State

The sum switch opens approx. 40 to 60 ms after the Advanced Safety Module changed to safe (HWBB) state by safety function request or alarm. This causes that the EDM Signal Output signal level changes to 0 V. In this case the **high active** EDM Signal Output signals the following invalid state that should be ignored:

- not in operation
- no working safety function

- no limit violation active
- no safe state active



The state of the EDM Signal Output displayed by the input signal monitor "Safety Module: I/O Monitor" (Un0A1 in the Digital Operator) is, however, polled via the CPU board of the Safety Module and remains at 24 V (ON), even if the EDM output falls back to zero 40 to 60 ms after an error occurs in the Safety Module due to the test pulse on the I/O board.

6.5.5.3 Safe Digital Output, Safe Digital Output Test Pulse (A, B)

At digital output ports A to D configured as Safe Digital Output or Safe Digital Output Test Pulse (A, B), a test pulse is generated in addition to the existing double test pulse generated by the sum switch. This test pulse is also generated when the signal level is ON (24 V).

The length of this test pulse must be specified in the Advanced Safety Module Parameter Editor. With the help of this test pulse, the line connected to the output is checked for open circuit, short circuit between two wires, stuck-at-1 or stuck-at-0 error.

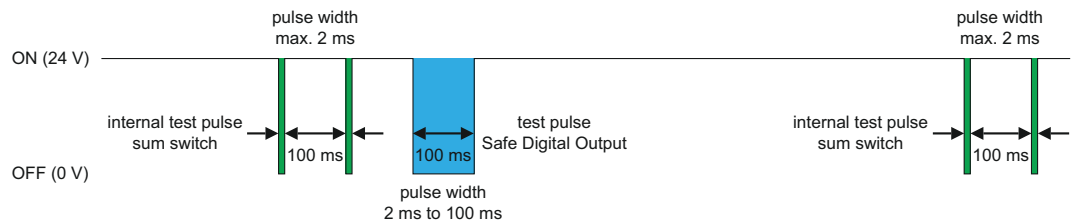

Fig. 29: Test Pulse on One Output Port (Width 100 ms)

Ports A to D configured as *Safe Digital Output* are used to connect to another **active** safety device like e.g. a safety controller or another Advanced Safety Module.

The length of a Safe Digital Output test pulse is to be parameterized in the *Advanced Safety Module Parameter Editor* and can be set in a range of 2 to 100 ms.

Ports A to D configured as *Safe Digital Output Test Pulse (A, B)* are used for **passive** switch relays that cannot generate and evaluate their own test pulses. These test pulses must therefore also be routed back to the safety module (port configured as Digital Input Test Pulse A or B, → 'Digital Input Configuration'...page 53).

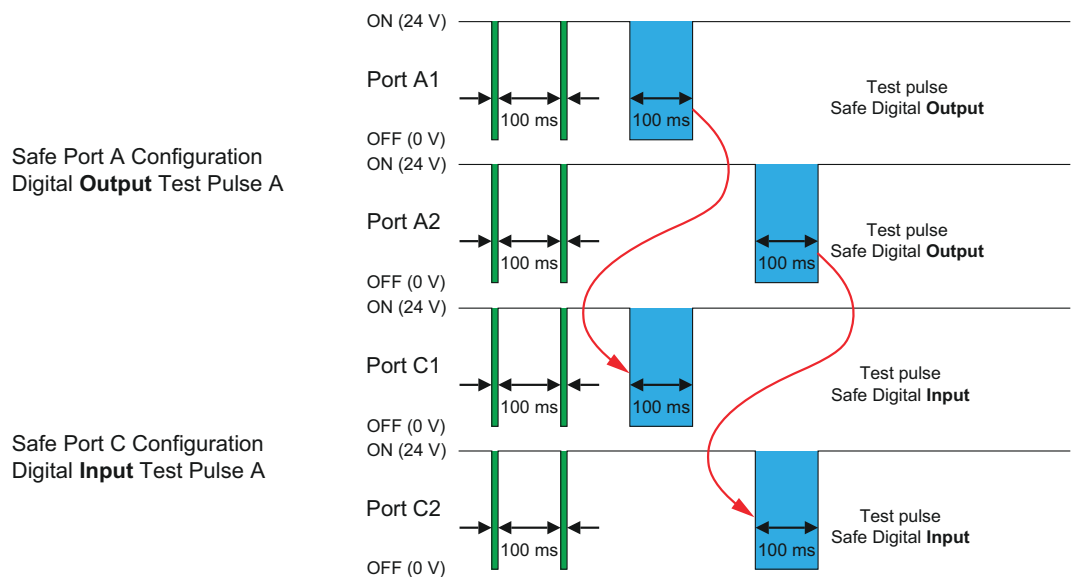

Fig. 30: Routing Back of Test Pulse A

The length of a Safe Digital Output Test Pulse (A, B) test pulse is to be parameterised in the *Advanced Safety Module Parameter Editor* and can be set in a range of 2 to 1000 ms.

If all output ports A to D are activated and a Safe Digital Output test pulse length of 100 ms is parameterised, about 3.5 s elapse between two internal tests, i.e. two consecutive double test pulses of the sum switch.

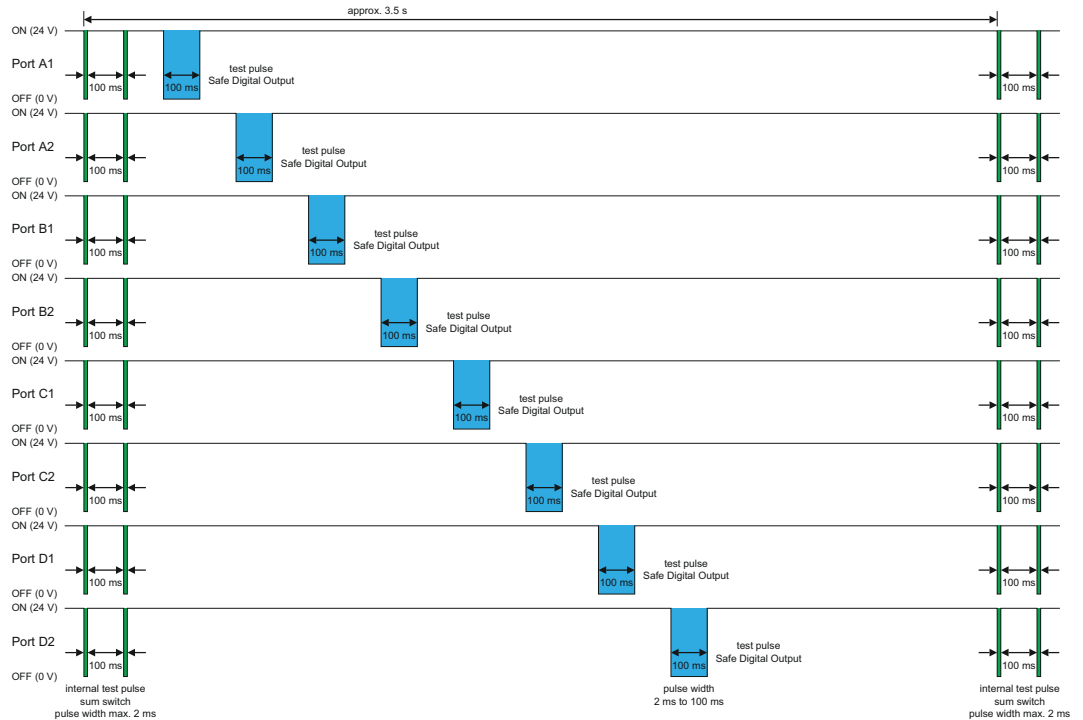

Fig. 31: Test Pulses on All Output Ports A to D (Width 100 ms)

Safe (HWBB) State

A state change of the Advanced Safety Module to safe (HWBB) state by safety function request or alarm causes that the signal level of a Safe Digital Output and Safe Digital Output Test Pulse (A, B) changes to 0 V. In this case the **low active** safe outputs signal the following states:

- limit violation active
- safe state active

6.6 Digital Input Configuration and Operation

A Digital Input can be used as Safety Function Activation Input or Data Input. Additionally, a Digital Input can be mapped to a Safe Digital Output, an EDM Output, or a Virtual Output.

For all selected input ports, the following parameters must be set to acceptable values:

- **Filter Time** is required to filter out test pulse signals
- **Discrepancy Time** is the time difference between dual input channels when one of them has its state changed.

Digital Input Status

Example - Activation Input Request for Slot 1

	Signal Name	State of Input	Electric State	State of Operation
Activation Input Request for Slot 1	Port A1 Signal	ON	24 V	Safety Slot 1 is inactive
		OFF	0 V	Safety Slot 1 is active
	Port A2 Signal	ON	24 V	Safety Slot 1 is inactive
		OFF	0 V	Safety Slot 1 is active

If input A1 and A2 are not in the same state within the specified time, alarm A.E11 (Safety Module: PIO A Error) will be generated.



The input signal should have a minimum pulse width of 1 ms plus the configurable filter time (0 to 1000 ms) in order to be recognized by the system as status change.

6.7 Analog Input Configuration and Operation

An Analog Input can be used as Safety Function Data Input for SLT or SMT.

- For input port F the following parameter must be set to an acceptable value:
 - **Channel Tolerance** is required to monitor the difference of the analog input signal level of both channels.
- For input port G no parameter must be set.

Monitoring Analog Inputs

It is possible to use the following monitors to check the input signals by SigmaWin+, Digital Operator or PLC:

Digital operator	EtherCAT Object Number		SigmaWin+	Units	Allowable tolerance (Max. acceptable deviation from the max. value) *1
	Index (hex)	Sub-index			
Un0C2	5A0Ch	1	Safety Module: Analog Input F1	1 mV	0 V: ±500 mV 10 V: ±750 mV
Un0C3	5A0Ch	2	Safety Module: Analog Input F2	1 mV	0 V: ±500 mV 10 V: ±750 mV
Un0C4	5A0Ch	3	Safety Module: Analog Input G1	1 µA	4 mA: ±0.2 mA 20 mA: ±1.5 mA
Un0C5	5A0Ch	4	Safety Module: Analog Input G2	0.1 °C	0 °C to 150 °C: ±11.3 °C < 0 °C: ±18.8 °C > 150 °C: ±18.8 °C

*1: The values are guaranteed for 20 years. A new product has a significantly better accuracy.

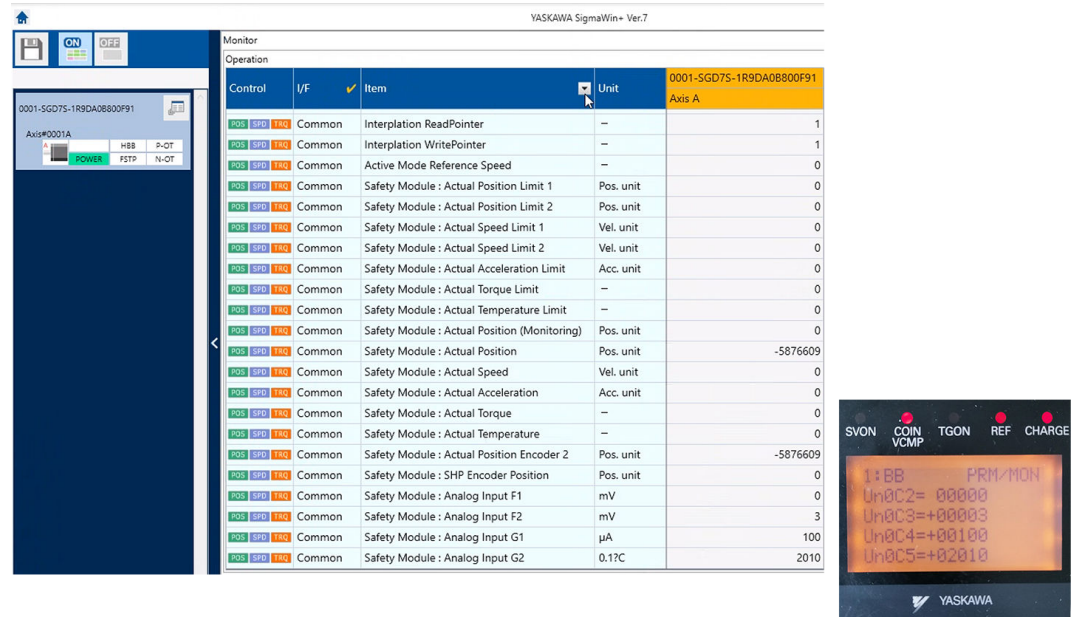

Fig. 32: Monitors for Analog Input Channels (SigmaWin+ and Digital Operator)

These monitors can be used to verify that the correct voltage, current, or temperature is arriving at the input channel if you suspect that line-related noise is present (due to poor grounding, for example).

Behavior of the Analog Ports F1 and F2 in Limit Cases

If the analog input voltage exceeds the allowed voltage of 10.2 V, the monitor value is set to 11 V. The 11 V is used to indicate the overflow of the analog signal. If the input value fluctuates around the maximum specified value (10.2 V), the monitor value may jump to 11 V in these cases.

The voltage input used for a safety function is always a dual channel input. A discrepancy in both channels or a value greater than the user-defined limit value in the safety function parameters will cause a limit violation alarm. This limit violation alarm (A.9C□) is also considered as broken wire or open wire alarm.

Behavior of the Analog Port G1 in Limit Cases

If the analog input current exceeds the allowed current of 20.3 mA, the monitor value is set to 21 mA. The 21 mA is used to indicate the overflow of the analog signal. If the input value fluctuates around the maximum specified value (20.3 mA), the monitor value may jump to 21 mA in these cases.

When the current input is used for a safety function, an input value of < 4 mA or a value greater than the user-defined limit value in the safety function parameters will cause a limit violation alarm. This limit violation alarm (A.9C□) is also considered as broken wire or open wire alarm.

6.8 Digital Output Configuration and Operation

A Digital Output can be used to monitor the Safety Function Status. A Digital Output can be configured as Safe Output or non-safe EDM Output.

For all selected safe digital output ports, the following parameter must be set to an acceptable value:

- Test Pulse Length is required to monitor e.g. line break

Digital Output Status

Example – Safety Function Status for Slot 1

Port B: Safe Output: 0 V During Safe State

	Signal Name	State of Output	Electric State	State of Operation	Remark
Safe Output	Port B1 Signal	ON	24 V	Safety Function A operates without abnormality	Safe Output (dual-channel digital output)
		OFF	0 V	Operation or usual safety function A of SERVOPACK breaks down	
	Port B2 Signal	ON	24 V	Safety Function A operates without abnormality	
		OFF	0 V	Operation or usual safety function A of SERVOPACK breaks down	

A Safe Output signal is by definition a "safe" signal. When using a two channel (i.e. redundant) *Activation Input*, the Safe Output is active as soon as one of the two activation channels is active.

Port C, Channel 1: EDM Signal Output: 24 V During Safe State

	Signal Name	State of Output	Electrical State	State of Operation	Remark
External Device Monitor	EDM-C1	ON	24 V	Operation or usual safety function A of SERVOPACK breaks down	Non-safe Output (single-channel digital output)
		OFF	0 V	Safety Function A operates without abnormality	

An EDM (External Device Monitor) signal is by definition not considered a "safe" signal. Nevertheless, when using a digital output as an EDM signal, this output behaves like a safe output due to its characteristics. As a result, when using a two-channel (i.e. redundant) *Activation Input*, the EDM signal is active as soon as one of the two activation channels is active.

6.8.1 Output Signal Behavior (Transition) of a Virtual Output, an EDM Output and a (Safe) Digital Output

Virtual Output

The output signal type **Virtual Output** is active high.

The choices for the output signal behavior are:

- TRUE during operation
- TRUE during working safety function
- TRUE after limit violation
- TRUE during safe state

For all choices above, the output signal behavior (transition) for the virtual output is shown graphically below:

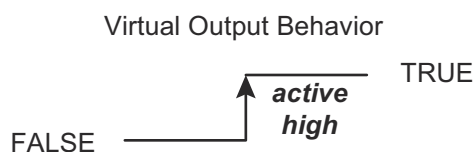

Fig. 33: Output Signal Behavior (Transition) for a Virtual Output

EDM Output

The output signal type **EDM Output** is active high.

The choices for the output signal behavior are:

- 24 V during operation
- 24 V during working safety function
- 24 V after limit violation
- 24 V during safe state

For all choices above, the output signal behavior (transition) for the EDM output is shown graphically below:

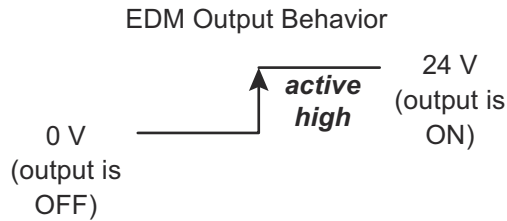

Fig. 34: Output Signal Behavior (Transition) for an EDM Output

(Safe) Digital Output

The output signal type **(Safe) Digital Output** is active low.

The choices for the output signal behavior are:

- 0 V after limit violation
- 0 V during safe state

For all choices above, the output signal behavior (transition) for the (safe) digital output is shown graphically below:

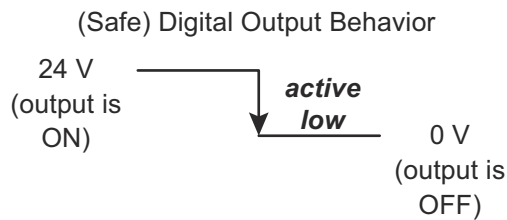

Fig. 35: Output Signal Behavior (Transition) for a (Safe) Digital Output

6.8.2 Reaction Time of a Digital Output When a Safety Function Is Activated

Activation input represents the input via which a safety function is activated. This input is **active low**.

The *Activation Input* has a configurable input filter. The figure below shows the status change of the *Activation Input* after this filter time is elapsed.

The *Safe Digital Output* is **active low**. The delay time $t_{dSafeOut}$ between the status change of the *Activation Input* and the status change of the *Safe Digital Output* is max. 7 ms (two cycles).

The *EDM Signal Output* is **active high**. The delay time t_{dEDM} between the status change of the *Activation Input* and the status change of the *EDM Signal Output* is max. 3.5 ms (one cycle).

Like can be seen is the behavior of a *Safe Digital Output* and an *EDM Signal Output* a little different. The reaction time of the *EDM Signal Output* is shorter. The reason is that EDM Signal Outputs are not defined as safe outputs. Therefore, the change in state of the EDM Signal Outputs is faster than with Safe Digital Outputs.



The EDM signal is not a safe signal. From EDM Signal Output, you can only deduce that the inputs have come and that a safety function has been addressed.

Configuration:

- Safety Function: STO
- Safe Digital Output: 0 V during safe state
- EDM Output: 24 V during safe state

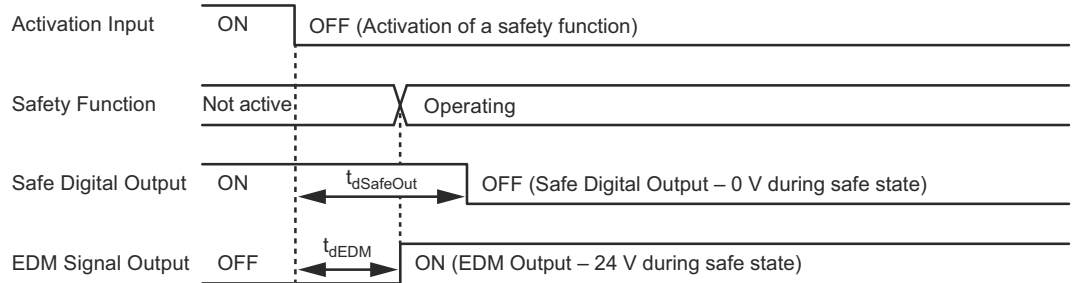

Fig. 36: Reaction Time of Safe Digital Output and EDM Output in Case of Activation of a Safety Function

Discrepancy Time Not Elapsed

The *Safe Digital Output* or *EDM Signal Output* is already active on the Advanced Safety Module when the first channel (in the example below channel 2) of the *Activation Input* is active. The safety function is started simultaneously. Note that the delay times $t_{d\text{SafeOut}}$ and $t_{d\text{EDM}}$ are not considered here.

Configuration:

- Safety Function: STO
- Safe Digital Output: 0 V during safe state
- EDM Output: 24 V during safe state

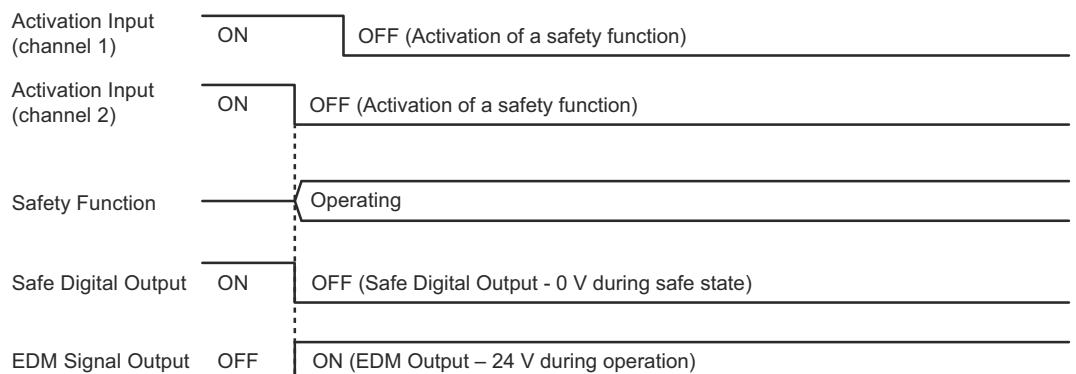

Fig. 37: Behavior of Safe Digital Output and EDM Output in Case of Activation Input Discrepancy Time Not Elapsed

Discrepancy Time Elapsed

The *Safe Digital Output* or *EDM Signal Output* is already active on the Advanced Safety Module when the first channel (in the example below channel 2) of the *Activation Input* is active. The safety function is started simultaneously. Note that the delay times $t_{d\text{SafeOut}}$ and $t_{d\text{EDM}}$ are not considered here.

After the Discrepancy Time is elapsed, the Safety Function changes to safe (HWBB) state. The EDM Output signal changes to low level after $t_{d\text{SumSwitch}}$ 40 to 60 ms.

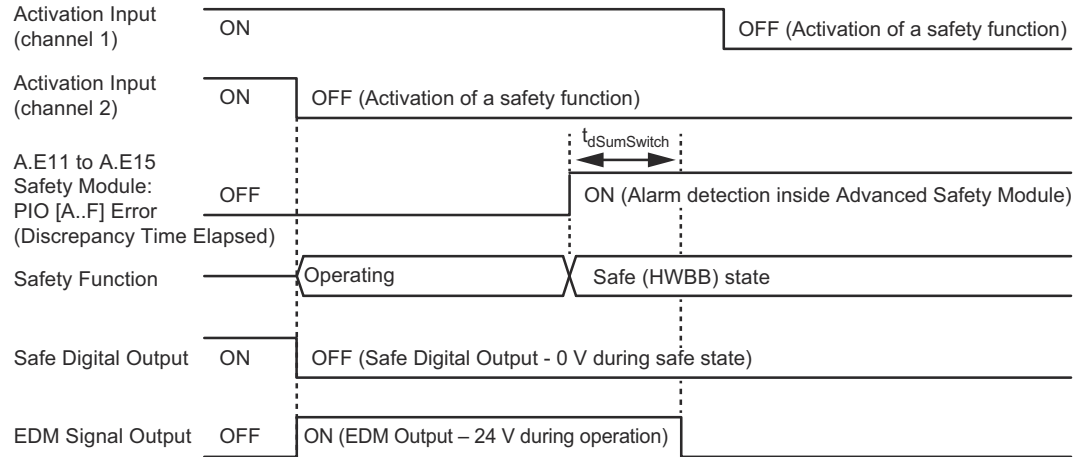

Fig. 38: Behavior of Safe Digital Output and EDM Output in Case Activation Input Discrepancy Time Elapsed

6.8.3 Reaction Time of a Digital Output When an Alarm is Detected by the Safety Module

Activation Input represents the input via which a safety function is activated. This input is **active low**, this means that the safety function is already active.



Note that the time behavior of the Safe Digital Output and EDM Signal Output is the same, if or if not a safety function is active.

Alarm represents an alarm that is detected inside the Advanced Safety Module.

When the alarm is detected, the Safe Digital Output reacts and goes within $t_{dSafeOut}$ max. 3.5 ms (one cycle) into safe status. This output is **active low**.

Since the *EDM Signal Output* is **active high**, the EDM signal is high when the safety function is active. When an alarm is detected inside the Advanced Safety Module, the EDM signal reacts within $t_{dSumSwitch}$ 40 to 60 ms and changes to low level.

Configuration:

- Safety Function: SLS (no limit violation active)
- Safe Digital Output: 0 V during safe state
- EDM Output: 24 V during safe state

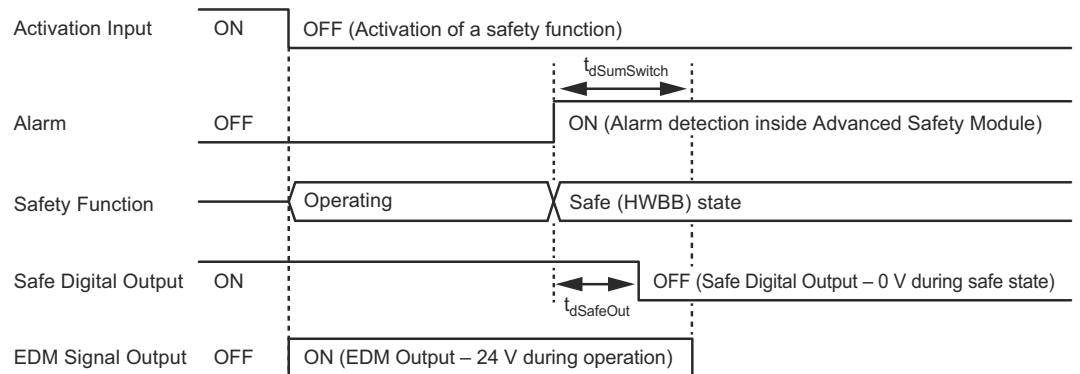

Fig. 39: Reaction Time of Safe Digital Output and EDM Output in Case of Alarm

6.8.4 Reaction Time of SERVOPACK Safe State Request

The signal *STO Request* includes if an alarm occurred or safety function requested the safe (HWBB) state.

The signal *SERVOPACK State* signals the delay time t_{dHWBB} until the SERVOPACK changes to “Safe (HWBB) State”. This delay is max. 6.5 ms.

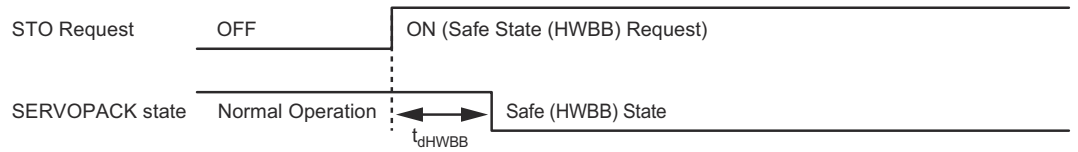

Fig. 40: Reaction Time of SERVOPACK Safe State Request

6.9 EMC Installation Conditions

This section gives the installation conditions that were used for EMC certification testing.

The EMC installation conditions that are given here are the conditions that were used to pass testing criteria at Yaskawa. The EMC level may change under other conditions, such as the actual installation structure and wiring conditions. These Yaskawa products are designed to be built into equipment. Therefore, you must implement EMC measures and confirm compliance for the final equipment.

The applicable standards are EN 55011 group 1 class A, EN 61000-6-2, EN 61000-6-4, and EN 61800-3 (category C2, second environment).

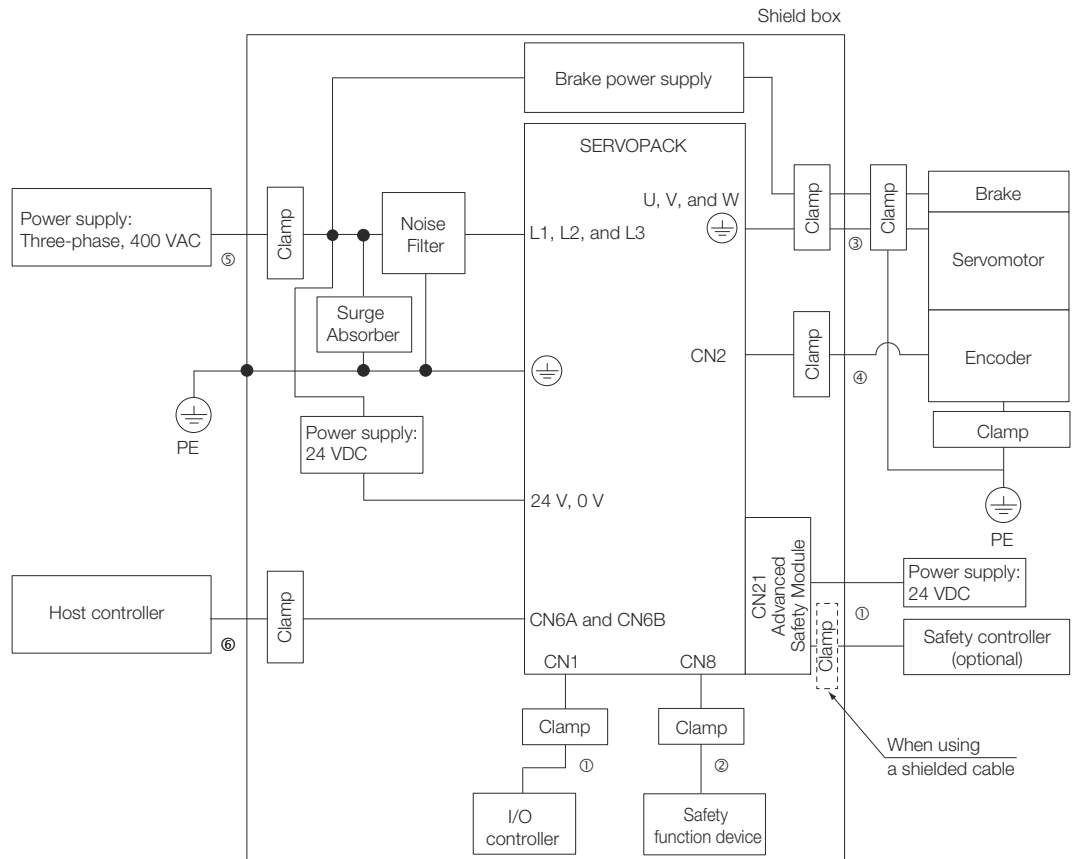

Fig. 41: Sigma-7 EtherCAT 400 V EMC Installation Conditions

Symbol	Cable Name	Specification
1	I/O Signal Cable:	
	■ Digital signals	■ Shielded ¹ or unshielded cable
	■ Analog signals	■ Shielded cable
2	Safety Function Device Cable	Shielded cable
3	Servomotor Main Circuit Cable	Shielded cable

Symbol	Cable Name	Specification
4	Encoder Cable	Shielded cable
5	Main Circuit Power Supply Cable	Shielded cable ²
6	EtherCAT Communications Cable	Shielded cable

1: If you use a shielded cable, ground the shield near the Advanced Safety Module with a clamp. There are no problems with single-ended grounding.

2: Recommended

6.10 Concept Example for Safety Integrity Level

6.10.1 Overview

When using safety functions that require encoder information (position, speed or acceleration), the achievable Safety Integrity Level differs depending on the encoder configuration.

Safety Functions	IEC 61800-5-2 abbreviation	IEC 61508 SIL Level	ISO 13849-1 Performance Level	Redundant Encoder
Safe Torque Off	STO	SIL 3	PL e, Cat. 3	No
Safe Stop 1 (ramp monitored / time monitored)	SS1-r SS1-t	SIL 3	PL e, Cat. 3	Yes
Safe Stop 2 (ramp monitored / time monitored)	SS2-r SS2-t	SIL 3	PL e, Cat. 3	Yes
Safe Operating Stop	SOS	SIL 3	PL e, Cat. 3	Yes
Safe Speed Limit	SLS	SIL 3	PL e, Cat. 3	Yes
Safe Limited Acceleration	SLA	SIL 3	PL e, Cat. 3	Yes
Safe Speed Range	SSR	SIL 3	PL e, Cat. 3	Yes
Safe Direction	SDI	SIL 3	PL e, Cat. 3	Yes
Safely Limited Position	SLP	SIL 3	PL e, Cat. 3	Yes
Safe Limited Increment	SLI	SIL 3	PL e, Cat. 3	Yes
Safe Limited Torque	SLT	SIL 3	PL e, Cat. 3	No
Safe Motor Temperature	SMT	SIL 3	PL e, Cat. 3	No
Safe Cam	SCA	SIL 3	PL e, Cat. 3	Yes
Safe Speed Monitor	SSM	SIL 3	PL e, Cat. 3	Yes



Single encoder configurations are possible and reaching SIL 2, PL d, Cat. 3. The function STO always reaches SIL 3, PL e, Cat. 3.

In case of the function SLT and SMT, the dual-channel analog input shall be used to reach SIL 3, PL e, Cat. 3. Additionally, the performance of the applied external sensor has to be considered.

6.10.2 For Rotary Servomotors or Direct Drive Servomotors

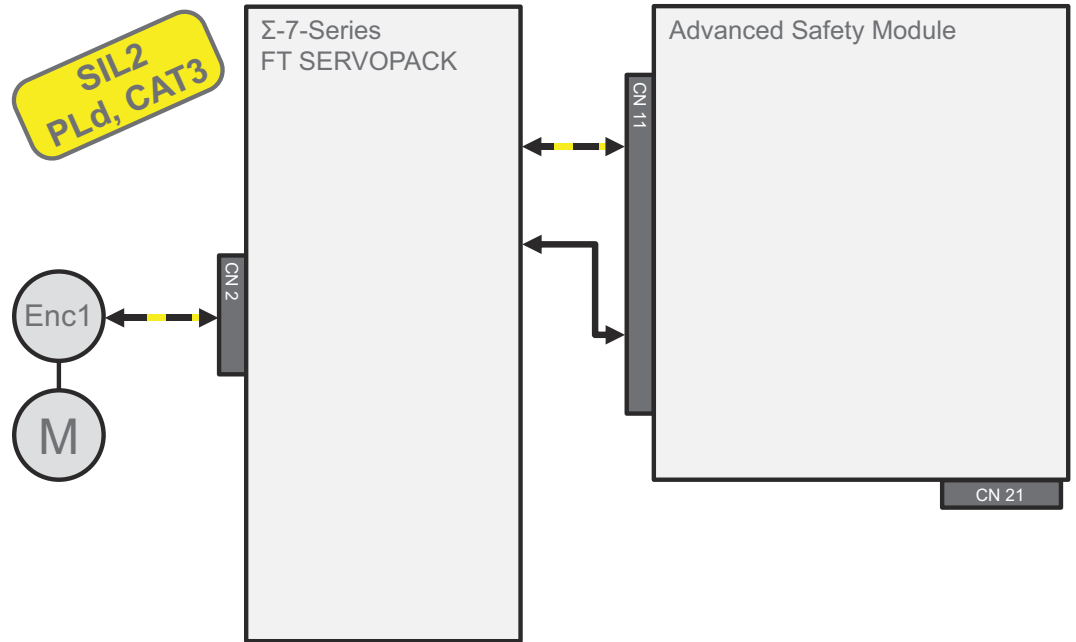

Fig. 42: One Encoder Configuration

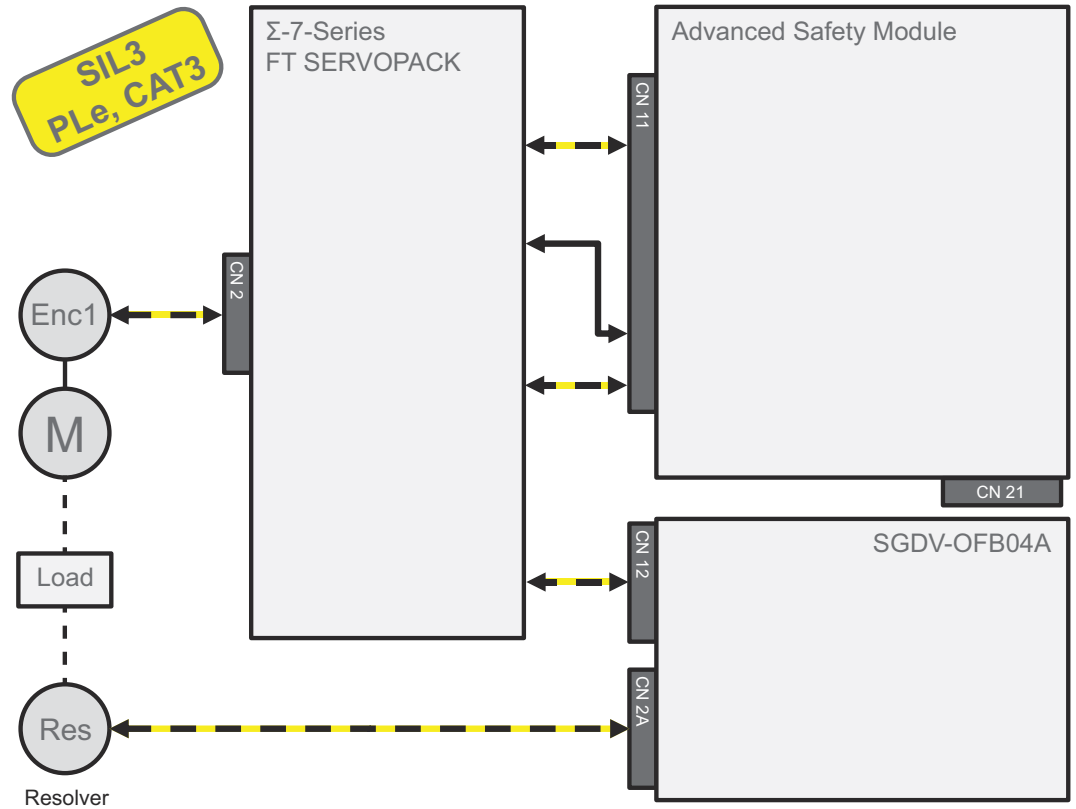

Fig. 43: Two Encoders Configuration With Resolver

Concept Example for Safety Integrity Level > For Linear Servomotors

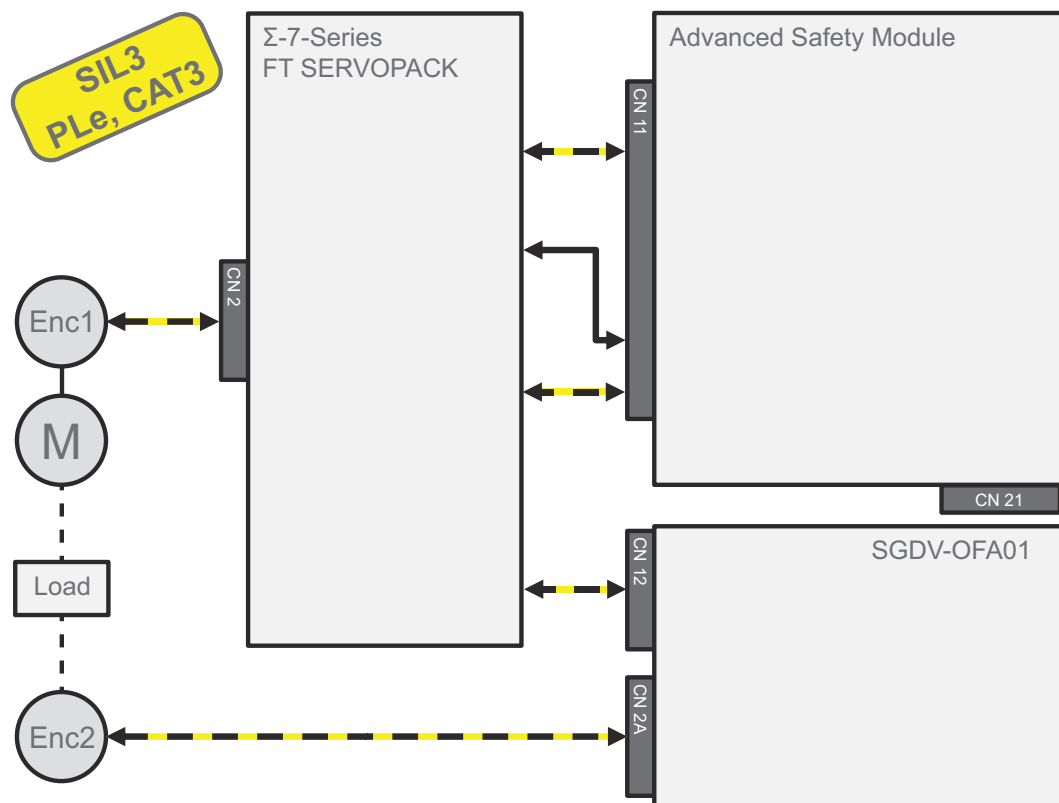

Fig. 44: Two Encoders Configuration With Yaskawa Encoder

6.10.3 For Linear Servomotors

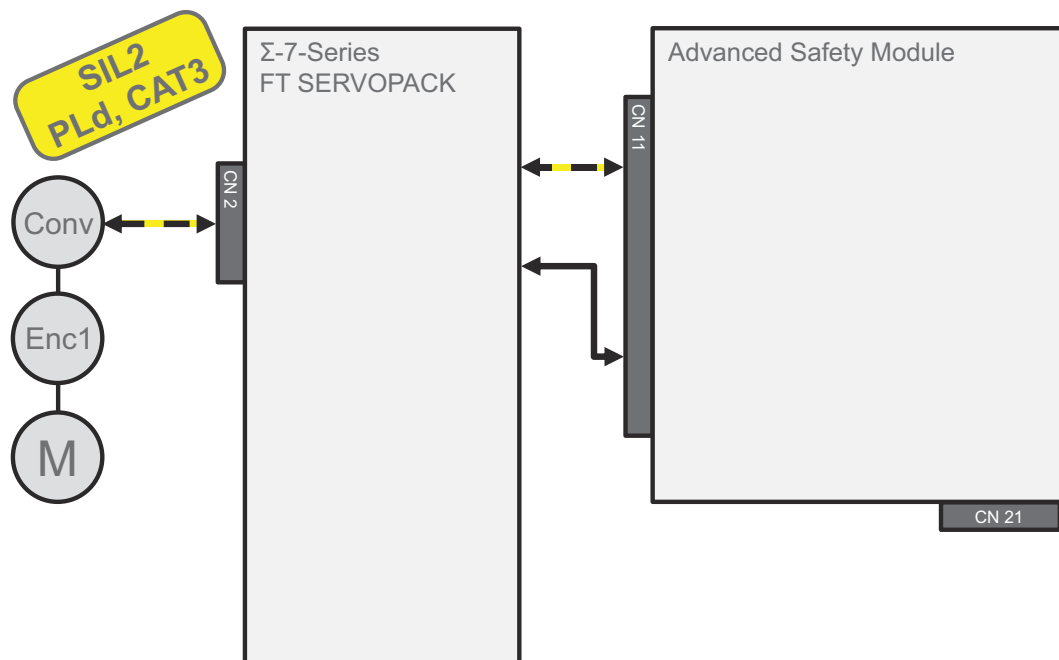

Fig. 45: One Encoder Configuration

Enc: Linear scale

Conv: Serial Converter (JZDP-H□□□-□□□ or JZDP-J□□□-□□□)



The mechanical connection of the linear encoders must be certified according to IEC 61800-5-2.

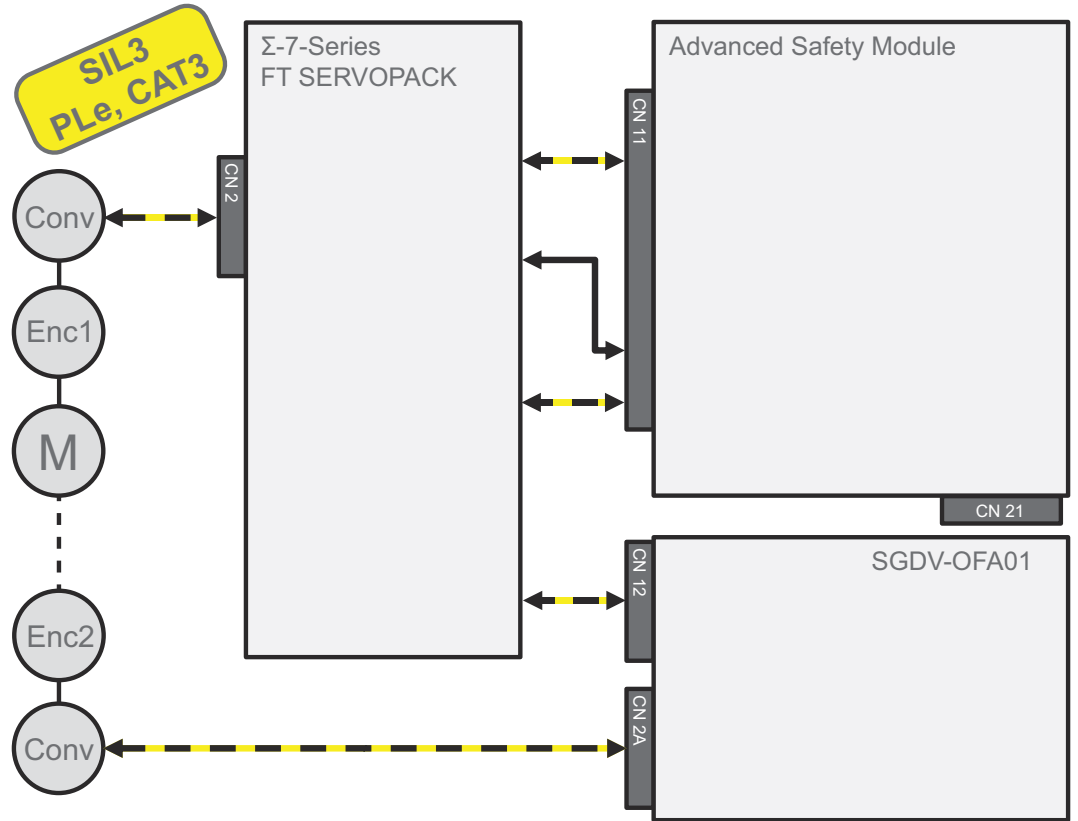

Fig. 46: Two Encoders Configuration

Enc: Linear scale

Conv: Serial Converter (JZDP-H□□□-□□□ or JZDP-J□□□-□□□)



The mechanical connection of the linear encoders must be certified according to IEC 61800-5-2.

7 Precautions and Basic Settings Required Before Starting Operation

7.1 Overview

This chapter describes information that is required before starting operation. Be sure to read the following safety precautions, risk assessment information, limitations, and basic settings before starting operation, and use the safety module after properly understanding all of this information.

7.2 General Safety Precautions

Operation Precautions



WARNING

- Before starting operation with a machine connected, change the settings of the switches and parameters to match the machine.
Unexpected machine operation, failure, or personal injury may occur if operation is started before appropriate settings are made.
- Do not radically change the settings of the parameters.
There is a risk of unstable operation, machine damage, or injury.
- Install limit switches or stoppers at the ends of the moving parts of the machine to prevent unexpected accidents.
There is a risk of machine damage or injury.
- For trial operation, securely mount the Servomotor and disconnect it from the machine.
There is a risk of injury.
- Forcing the motor to stop for overtravel is disabled when the Jog, Origin Search, or Easy FFT utility function is executed. Take necessary precautions.
There is a risk of machine damage or injury.
- When an alarm occurs, the motor will coast to a stop or stop with the dynamic brake according to a setting in the SERVOPACK. The coasting distance will change with the moment of inertia of the load. Check the coasting distance during trial operation and implement suitable safety measures on the machine.
- Do not enter the machine's range of motion during operation.
There is a risk of injury.
- Do not touch the moving parts of the Servomotor or machine during operation.
There is a risk of injury.

**CAUTION**

Design the system to ensure safety even when problems, such as broken signal lines, occur. For example, the P-OT and N-OT signals are set in the default settings to operate on the safe side if a signal line breaks. Do not change the polarity of this type of signal.

- When overtravel occurs, the power supply to the motor is turned OFF and the brake is released. If you use the Servomotor to drive a vertical load, set the Servomotor to enter a zero-clamped state after the Servomotor stops. Also, install safety devices (such as an external brake or counterweight) to prevent the moving parts of the machine from falling.
- Always turn OFF the servo before you turn OFF the power supply. If you turn OFF the main circuit power supply or control power supply during operation before you turn OFF the servo, the Servomotor will stop as follows:
 - If you turn OFF the main circuit power supply during operation without turning OFF the servo, the Servomotor will stop abruptly with the dynamic brake or it will coast to a stop.
 - If you turn OFF the control power supply during operation without turning OFF the servo, the Servomotor will stop abruptly with the dynamic brake or it will coast to a stop. For details, refer to the manual for the SERVOPACK.
 - If you use an External Dynamic Brake Resistor, the Servomotor stopping method will be different from when the built-in dynamic brake resistor is used. For details, refer to the product manual for your SERVOPACK.
- Do not use the dynamic brake for any application other than an emergency stop.

There is a risk of failure due to rapid deterioration of elements in the SERVOPACK and the risk of unexpected operation, machine damage, burning, or injury.

**NOTICE**

- When you adjust the gain during system commissioning, use a measuring instrument to monitor the torque waveform and speed waveform and confirm that there is no vibration.

If a high gain causes vibration, the Servomotor will be damaged quickly.

- Do not frequently turn the power supply ON and OFF. After you have started actual operation, allow at least one hour between turning the power supply ON and OFF (as a guideline).

Do not use the product in applications that require the power supply to be turned ON and OFF frequently.

The elements in the SERVOPACK will deteriorate quickly.

- An alarm or warning may occur if communications are performed with the host controller while the SigmaWin+ or Digital Operator is operating.

If an alarm or warning occurs, it may interrupt the current process and stop the system.

- After you complete trial operation of the machine and facilities, use the SigmaWin+ to back up the settings of the SERVOPACK parameters. You can use them to reset the parameters after SERVOPACK replacement.

If you do not copy backed up parameter settings, normal operation may not be possible after a faulty SERVOPACK is replaced, possibly resulting in machine or equipment damage.

- The proper condition of the SERVOPACK's fan must be checked before commissioning the safety module. The maintenance and cleaning of the fan must be made at least once a year.

7.3 Safety Precautions for Using the Safety Module

Carefully read the following important precautions and observe them when using the safety module.



WARNING

- Installation or disassembly must be performed only by authorized personnel.
Failure to observe this precaution may result in electric shock or injury.
- The dynamic brake is not a safety-related part of a control system. Create the safety design of the mechanical system in such a way that any trouble in the dynamic brake function does not create a hazard when the safety functions of the safety module operate.
Improper use may result in injury or damage to the product.
- Connect device conforming to the relative safety standards to the connector for the safe ports.
Improper use may result in injury or damage to the product.
- The safety functions of the safety module are not for shutting OFF the power supply to the SERVOPACK and do not provide electrical isolation. Be sure to separately shut OFF the power supply to the SERVOPACK when performing maintenance or inspection of the SERVOPACK.
Failure to observe this warning may result in electric shock.
- Be sure to check the safety-related parameters before using the safety functions of the safety module.
Improper use may result in injury or damage to the product.
- If the safety module or SERVOPACK is changed when starting the servo system or during maintenance or inspection, be sure to check the operation of the safety functions in the actual application after performing wiring.
Improper use may result in injury or damage to the product.

7.4 Planning of a Safety-Oriented Control System

7.4.1 General

The entire process of defining the safety system is carried out in the planning phase. In addition to risk assessment, the planning contains the detailed definition of all system components, the definition of the system parameters and the detailed installation and wiring of the components.



WARNING

Engineers designing a mechanical system using the safety functions of the safety module must have complete knowledge of the relative safety standards and a full understanding of the safety functions of the safety module.

Improper use may result in injury or damage to the product.



DANGER

Conducting the planning thoroughly aids in avoiding failures.

Failures in safety-oriented machines can lead to permanent injuries and death.

7.4.2 Risk Assessment

**WARNING**

When creating a safety design for a mechanical system using the safety functions of the safety module, always perform risk assessment of the system in accordance with DIN EN ISO 12100-1 and EN ISO 14121 to identify residual risks.

Improper use may result in injury or damage to the product.

The risk assessment establishes which dangers a machine can present and which plant parts will have to be equipped with safety technology devices. The residual risk is reduced to a justifiable level by means of safety technology measures.

**CAUTION**

- As machine manufacturer, the applicable machine guidelines obligate you to conduct a risk assessment in order to establish the dangers associated with the machine and reduce the residual risk to a justifiable minimum.
- It is absolutely necessary to conduct the risk assessment during the planning phase and before conducting retrofitting work.

When using the safety module, be sure to perform risk assessment of the servo system in advance. Make sure that the safety level of the standards is met. For details about the standards, refer to Harmonized Standards at the front of this manual.

The risk assessment should be conducted according to the procedure described in the following.

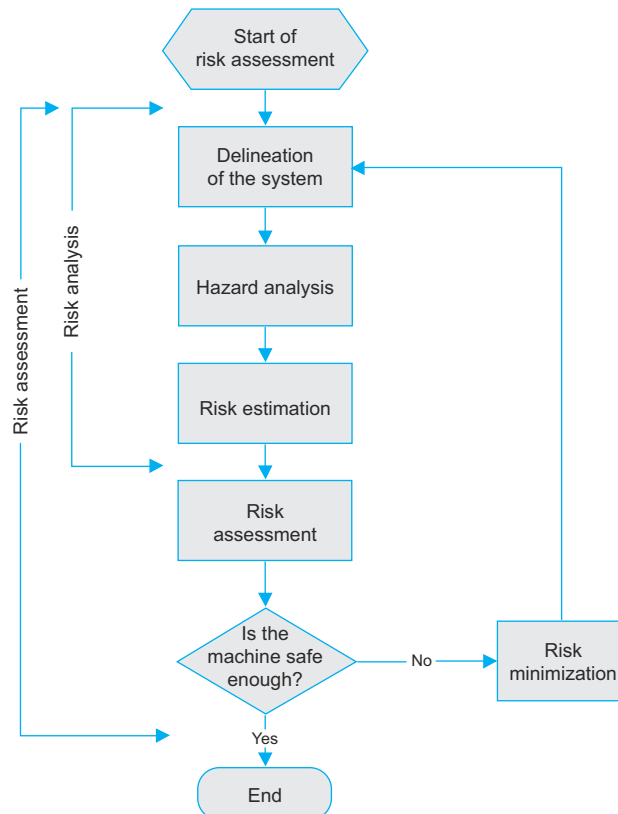

Fig. 47: Risk Assessment Procedure in Accordance With DIN EN ISO 12100-1 and EN ISO 14121

Delineation of the system Determination of the limits of the system's boundaries and the intended use

Hazard analysis Identification of hazards and the related hazardous situations

Risk estimation
Risk assessment

Estimation of the risks for each hazard identified
Assessment of the risks and establishment of risk reduction measures

The determination of the required safety class (SIL according to EN 62061 and performance level according to EN ISO 13849-1) is carried out in the scope of risk assessment for the installation/machine in accordance with EN ISO 12100-1 and EN ISO 14121.

The standard IEC 61508 defines four different safety levels which describe the measures for handling the risks. These four safety levels are the **Safety Integrity Level (SIL)** defined by the standards.

The higher the number of the Safety Integrity Level (SIL), the higher the reduction of the risk. The SIL is therefore a relative measure of the probability that the safety system can correctly provide the required safety functions for a specific period.

There are different approaches for determining the required SIL. The standard IEC 61508 includes various methods for defining the SIL. Since the topic is extremely complex, only the *qualitative method* necessary to obtain basic understanding is presented here.

The qualitative method is a simplified model which readily shows which SIL is required for which hazards.

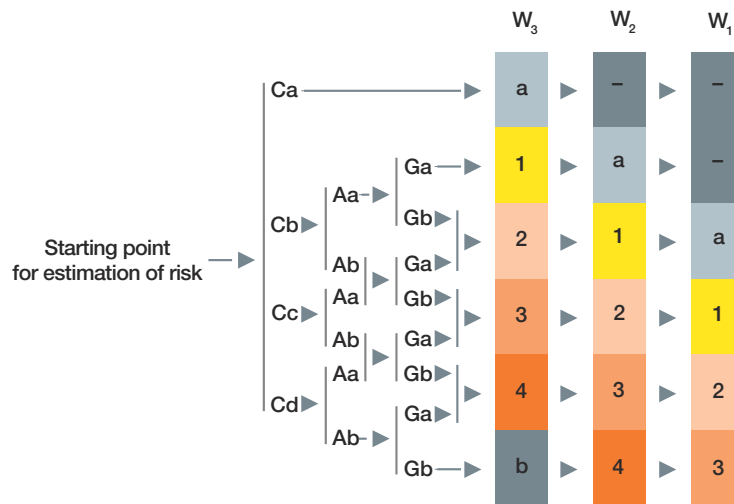

Fig. 48: Determination of SIL According to the Qualitative Method

- a no special safety requirements
- b a single Safety Instrumented System (SIS) is insufficient
- 1, 2, 3, 4 Safety Integrity Level (SIL)

Extent of Damage

Ca	Light injury of a person, small environmental damage
Cb	Severe injury or death of a person
Cc	Death of several persons
Cd	Death of very many persons

Duration of Stay of a Person in the Dangerous Area

Aa	Seldom to frequent
Ab	Frequent to permanent

Aversion of Danger

Ga	Possible under certain conditions
Gb	Hardly possible

Probability of Occurrence	
W ₁	Very low
W ₂	Low
W ₃	Relatively high

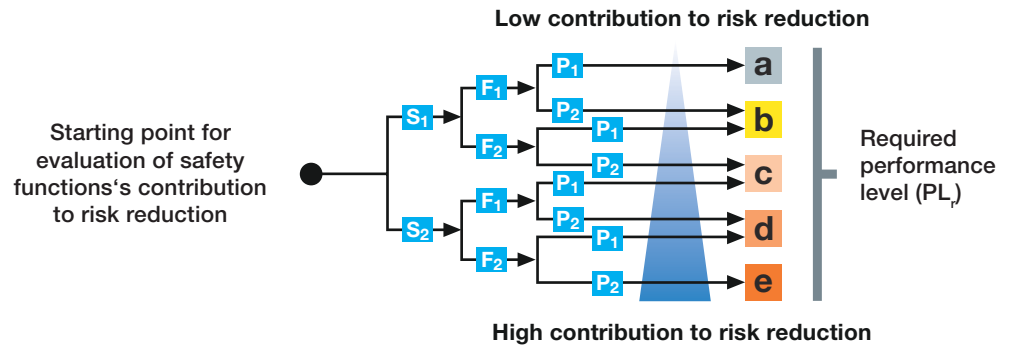

Fig. 49: Determination of the Required Performance Level

Severity of Injury	
S ₁	Slight (normally reversible injury)
S ₂	Serious (normally irreversible injury or death)

Frequency and/or Duration of Exposure to a Hazard	
F ₁	Seldom to quite often and/or exposure time is short
F ₂	Frequent to continuous and/or exposure time is long

Possibility of Avoiding the Hazard or Limiting the Harm	
P ₁	Possible under specific conditions
P ₂	Scarcely possible

Residual Risks

The following residual risks can be present even when the safety functions operate. Therefore, safety must always be given consideration during risk assessment.

- If external forces (such as gravitational force with a vertical axis) are applied when the safety functions of the safety module are operating, the motor will rotate due to the action of these external forces. Provide a separate mechanical brake to secure the motor.
- If the SERVOPACK fails, e.g. due to the failure of two output transistors, a current can flow through the motor winding. This current then leads to a rotor movement of maximum 180 degrees (electrically). Make sure that such a situation does not affect the safety of the application.

The number of rotations and movement distance for each type of motor are listed below.

Rotary Servomotor	1/6 rotation max. (rotation angle at motor shaft conversion)
Direct Drive Motor	1/20 rotation max. (rotation angle at motor shaft conversion)
Linear Servomotor	30 mm max.

Installation and Wiring Plan

An installation and wiring plan for the entire safety system is to be developed in the planning phase. It contains all system components and its wiring.

**CAUTION**

The applicable standards and guidelines on laying electrical lines must be observed when developing the wiring plan.

Course of the Planning Phase

The system is planned according to the requirements of the installation or the machine. Prior to commissioning of the safety module, the following must be checked and guaranteed:

- Compatibility of the safety module with the controller
- Adequate supply of the controller by the connected power supply unit or safety components.

7.5 Limitations

7.5.1 Limitations on the Use of the Test Without Motor Function

The test without motor function of the SERVOPACK cannot be used together with the safety functions of the safety module.

When using the safety functions, disable the test without motor function of the SERVOPACK being used.

7.5.2 Limitation When Setting the Communication Channel for the USB Connection

The communication channel for the USB connection in SERVOPACK parameter Pn010 (Axis Address Selection for UART/USB Communications) must always be set to "0001h" for the period of communication with the *Advanced Safety Module Parameter Editor*.

This is the default value for the parameter Pn010. However, if it is not possible to establish communication via USB, the correct setting of this parameter should be checked in any case.

7.5.3 Device Combination

Due to the safety functions, the safety module can be used with limited models of SERVOPACKs, servomotors, and serial converters. *For details, refer to ↗ 'Device Combinations'...page 310.*

7.6 Basic Settings Required Before Starting Operation

7.6.1 Overview

The basic functions that must be set before starting operation are given below.

Step	Item	Reference
1	Disabling the Test without Motor Function	↗ <i>'Disabling the Test Without Motor Function'...page 81</i>
2	Safety Option Module Setup Alarm Clear	↗ <i>'Safety Option Module Setup Alarm Clear'...page 81</i>
3	Determine the configuration of the motor and encoder to be used.	↗ <i>'Configuration of the Motor and Encoder'...page 81</i>
4	Setting motor information	↗ <i>'Setting Motor Information'...page 83</i>
5	Setting encoder information	↗ <i>'Setting Encoder Information'...page 83</i>

Step	Item	Reference
6	Safety-related Module Parameter Setting	→ 'Safety-Related Module Parameter Setting'...page 85

7.6.2 Disabling the Test Without Motor Function

The test without motor function of the SERVOPACK cannot be used together with the safety functions of the safety module.

When using the safety functions, disable the test without motor function of the SERVOPACK being used.

To disable it, set the following SERVOPACK parameter:

Parameter No.	Size	Name	Setting Range	Setting Unit	Default Setting	Applicable Motors	When Enabled	Classification
Pn00C (200Ch)	2	Application Function Selections C	0000h to 0131h	–	0000h	–	After restart	Setup

n.□□□X	Function Selection for Test without a Motor	Applicable Motors
0	Disable tests without a motor.	All
1	Enable tests without a motor.	

7.6.3 Safety Option Module Setup Alarm Clear

Clear the Safety Module Confirmation Alarm (A.EC0) → 'Solid Detection Function'...page 150.



To execute this feature, the Digital Operator (JUSP-OP05A-1-E) or the Advanced Safety Module Parameter Editor (PC configuration tool) is needed.

7.6.4 Configuration of the Motor and Encoder

Determine the configuration of the motor and encoder to be used, then install and wire.

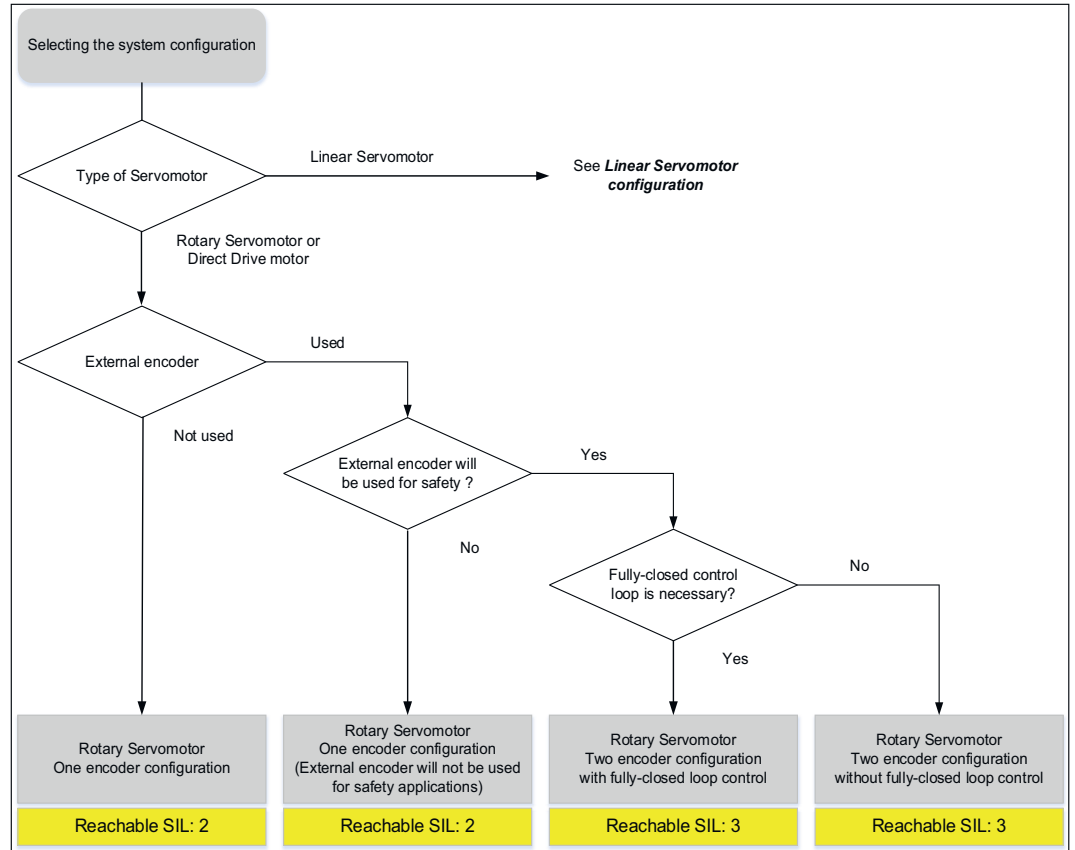

Fig. 50: Motor Configuration

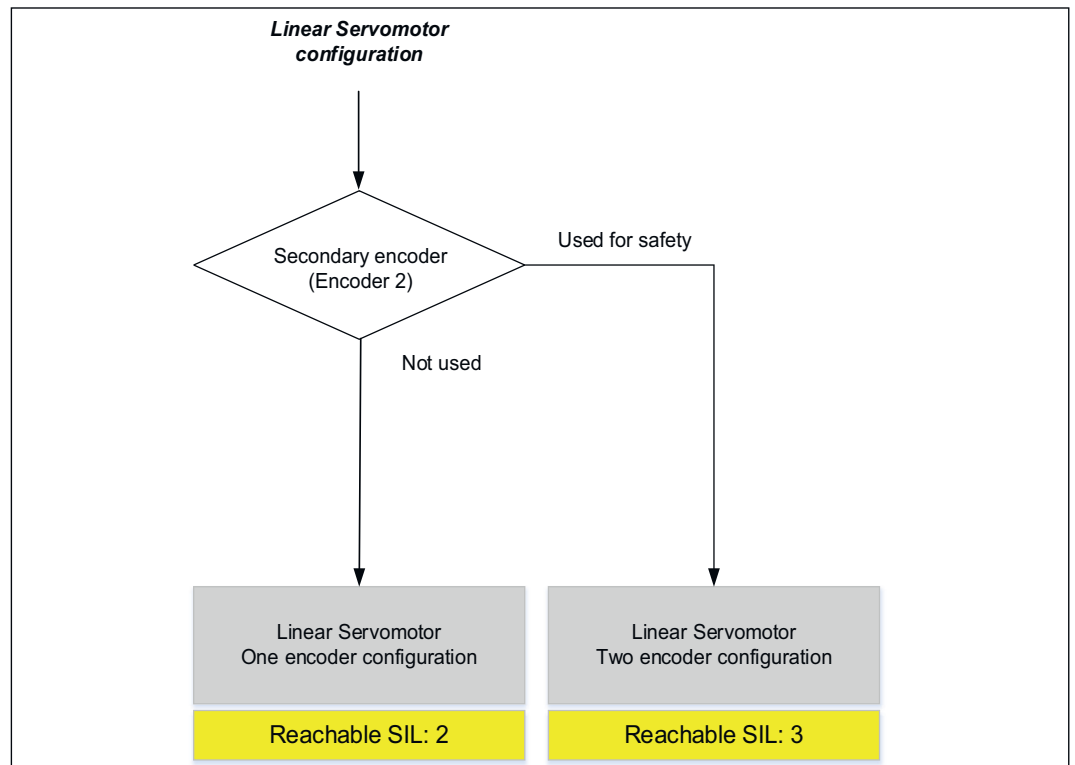

Fig. 51: Encoder Configuration

Selected Configuration

Servomotor	External encoder usage				Reachable SIL	Configured Type
	Use	Safety application	Fully-closed control loop	Without fully-closed control loop		
Rotary Servomotors or Direct Drive motors	No	No	No	No	2	Rotary 1
	Yes	No	No	No	2	Rotary 2
	Yes	Yes	Yes	No	3	Rotary 3
	Yes	Yes	No	Yes	3	Rotary 4

Servomotor	External encoder usage		Reachable SIL	Configured Type
	Use	Safety application		
Linear Servomotors	No	No	2	Linear 1
	Yes	Yes	3	Linear 2

The selected **Configured Type** will be used for the next steps.

7.6.5 Setting Motor Information

Set the motor information for each selected **Configured Type**.

Configured Type	Rotation Direction Selection	Maximum Motor Speed
Rotary 1	Pn000 = n.□□□X	Pn316
Rotary 2		
Rotary 3		
Rotary 4		

Configured Type	Movement Direction	Maximum Motor Speed
Linear 1	Pn000 = n.□□□X	Pn385
Linear 2		

Further information on the related parameters can be found in the following manual:

Name	Manual number
Σ-7-Series AC Servo Drive Σ-7S SERVOPACK with 400V-Input Power and EtherCAT (CoE) Communications References FT/EX Specification for Advanced Safety Module Product Manual	SIEP S800002 30

7.6.6 Setting Encoder Information

Set Encoder information for each selected **Configured Type**.

Configured Type	Multi-turn limit *1	External Encoder Usage	External Encoder Monitor Selection	Encoder Resolution *2	
				Rotary Encoder	Linear Scale
Rotary 1	Pn205	Pn002 = n.0□□□	Pn00E = n.0□□□	N/A	N/A
Rotary 2		*2	*2	*2	*2
Rotary 3		Pn002 = n.X□□□	Pn00E = n.0□□□	Pn00E = n.□□□1 Pn23E	Pn00E = n.□□□0 Pn246
Rotary 4		Pn002 = n.0□□□	Pn00E = n.X□□□		

Configured Type	External Encoder Monitor Selection	Encoder Resolution *3	
		Rotary Encoder	Linear Scale
Linear 1	Pn00E = n.0□□□	N/A	N/A
Linear 2	Pn00E = n.X□□□	Pn00E = n.□□□1 Pn23E	Pn00E = n.□□□0 Pn246

*1. Only when using multi-turn absolute encoder

*2. Do not care for safety application. Set for servo control.

*3. Encoder Resolution should be set depending on External Encoder type.

Rotary Encoder	Linear Scale
JZDP-Z001-000 JZDP-Z002-000 Resolver	Linear scale which can be connected to the Serial Converter JZDP-H00□ -□□□ or JZDP-J00□-□□□

Related Parameters of SERVOPACK

Application Function Selections E

Parameter No.		Name	Meaning	When Enabled	Classification
Pn00E (200Eh)	n.□□□0 (default setting)	Resolution calculating method of an external encoder	Linear scale: Use Pn246 or set value inside a scale.	After restart	Setup
	n.□□□1		Rotary encoder: Use the number of external encoder pulses (Pn23E)		

Number of External Encoder Pulses

Parameter No.	Setting Range	Setting Unit	Default Setting	When Enabled	Classification
Pn23E (223Eh)	0 to 16777216	1 P/Rev	0	After restart	Setup

External Encoder Scale Pitch

Parameter No.	Setting Range	Setting Unit	Default Setting	When Enabled	Classification
Pn246 (2246h)	0 to 6553600	0.01 μm	0	After restart	Setup

Further information on the related parameters can be found in the following manual:

Name	Manual number
Σ-7-Series AC Servo Drive Σ-7S SERVOPACK with 400V-Input Power and EtherCAT (CoE) Communications References FT/EX Specification for Advanced Safety Module Product Manual	SIEP S800002 30

7.6.7 Safety-Related Module Parameter Setting

Follow the steps below to create Safety-related Module Parameters (a so-called Safe Container) and download them to the safety module.

1. [Create the Safety-related Module Parameters](#) → [‘Safety-Related Module Parameters’...page 138](#).
2. [Download the Safety-related Module Parameters to the safety module](#) → [‘Parameterisation With the Advanced Safety Module Parameter Editor’...page 141](#).

After downloading the Safe Container to the safety module, if a **Safety-related Servo Parameter Unmatch Alarm (A.EC1)** has appeared, there are unmatched parameters in the Safety-related Servo Parameters.

To check the unmatched parameters, **Fn042 (Safety-related Servo Parameter Confirmation)** or the Advanced Safety Module Parameter Editor (PC configuration tool) is available.

Refer to [‘Utility Functions for Editing Parameters’...page 156](#) to execute Fn042.

8 Safety Functions

8.1 Overview

This chapter describes the supported safety functions of the safety module.



For information on the system's reaction time, refer to chapter → 'Typical Reaction Time'...page 40.

For information on the achievable Safety Integrity Level, refer to chapter → 'Concept Example for Safety Integrity Level'...page 70.

8.2 Safety Features

8.2.1 General

The safety module is equipped with up to 16 different safety functions to provide machine safety. These functions reduce risks during usage of the machine by protecting people from hazardous operations of movable machine parts. The stopping function that is defined in functional safety standards can be achieved with 5 safety stop functions.

Basic Safety Functions

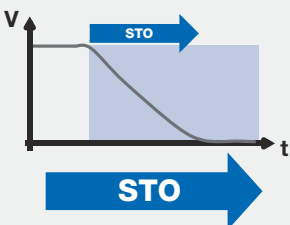
Type	Short	Function
Safe Switch-Off (Safe Base Block Function)	STO 	Safe Torque Off This function shuts OFF the power supply to the motor by executing the HWBB function of the SERVOPACK. The drive cannot generate any hazardous movements. If STO is activated when the drive is moving, the motor will run down in an uncontrolled manner.

Advanced Safety Functions

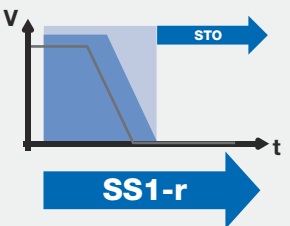
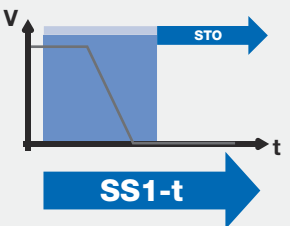
Type	Short	Function
Safe Standstill	SS1-r 	Safe Stop 1, Ramp Monitored The safety module will activate STO : <ul style="list-style-type: none"> if the speed limit is exceeded during deceleration after the monitoring time has elapsed
Safe Standstill	SS1-t 	Safe Stop 1, Time Monitored The safety module will activate STO : <ul style="list-style-type: none"> after the monitoring time has elapsed

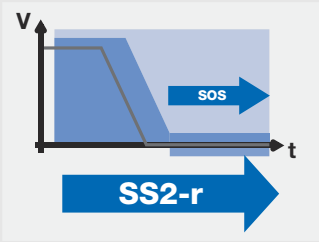
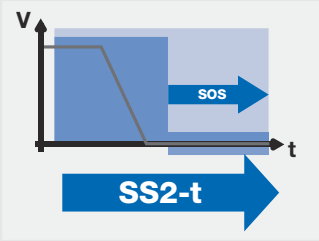
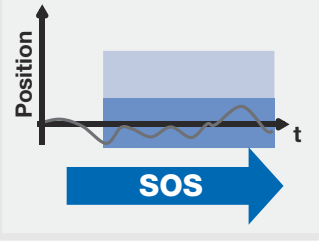
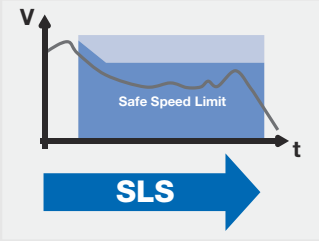
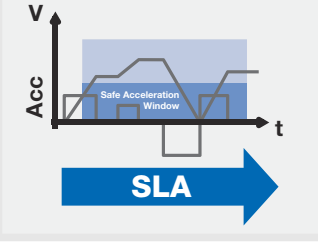
Type	Short	Function
Safe Standstill	SS2-r 	Safe Stop 2, Ramp Monitored The safety module will activate STO : <ul style="list-style-type: none"> if the speed limit is exceeded during deceleration The safety module will activate SOS : <ul style="list-style-type: none"> after the monitoring time has elapsed (provided that no limit violation has occurred during deceleration). If the position deviation exceeds the limit, the safety module will activate STO .
Safe Standstill	SS2-t 	Safe Stop 2, Time Monitored The safety module will activate SOS : <ul style="list-style-type: none"> after the monitoring time has elapsed. If the position deviation exceeds the limit, the safety module will activate STO .
Safe Standstill	SOS 	Safe Operating Stop By activation, the safety module will switch to position monitoring. If the position deviation exceeds the limit, the safety module will activate STO .
Safe Motion	SLS 	Safely Limited Speed By activation, the safety module starts to monitor the speed (first deceleration monitoring, then constant speed monitoring). If any speed limit is violated, the safety module will activate the selected stopping method, for example STO (default).
Safe Motion	SLA 	Safely Limited Acceleration This function monitors the acceleration operation of the motor. If the specified acceleration speed is exceeded, the safety module will activate the selected stopping method, for example STO (default).

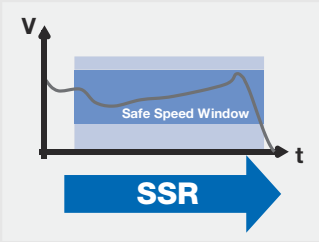
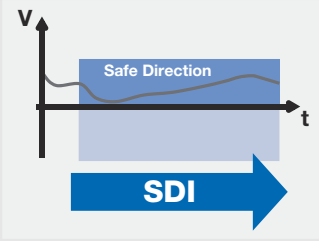
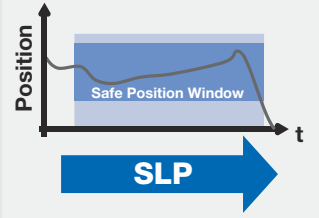
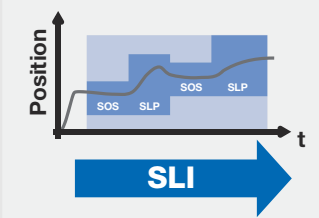
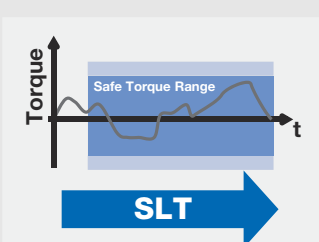
Type	Short	Function
Safe Motion	SSR	<p>Safe Speed Range</p> <p>This function adds minimum speed monitoring to the SLS function. In other words, the maximum speed must not exceed a certain value, and the minimum speed must not drop below a certain value.</p> <p>If either of these limits is violated, the safety module will activate the selected stopping method, for example STO (default).</p>
		
Safe Motion	SDI	<p>Safe Direction</p> <p>This function prevents the motor from moving in an invalid direction, it can only move in one (defined) direction.</p> <p>If the specified direction is violated, the safety module will activate STO.</p>
		
Safe Positioning	SLP	<p>Safely Limited Position</p> <p>This function monitors the end positions of previously defined ranges.</p> <p>If the actual position exceeds the limits, the safety module will activate the selected stopping method, for example STO (default).</p>
		
Safe Positioning	SLI	<p>Safely Limited Increment</p> <p>This function monitors the movements of the drive for compliance with a defined increment. The reference position is defined when monitoring is activated.</p> <p>If a limit value is violated, the safety module will activate STO or the selected stopping method, for example STO (default).</p>
		
Safe Motion	SLT	<p>Safely Limited Torque</p> <p>This function monitors the torque and compares it to the limit.</p> <p>If the torque limit is violated, the safety module will activate the selected stopping method, for example STO (default).</p>
		

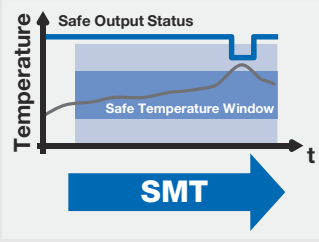
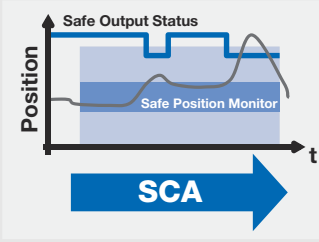
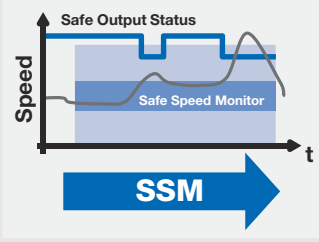
Type	Short	Function
Safe Monitoring	SMT 	Safe Motor Temperature <p>This function monitors the temperature and compares it to the limit values. If the temperature limit is violated, the safety module will deactivate the assigned output.</p> <p>Please note that this is a monitoring function that does not activate a stopping method after a limit violation.</p>
Safe Monitoring	SCA 	Safe Cam <p>This function provides a safe output signal to indicate whether the motor shaft position is within a specified range. If the actual position exceeds the limits, the safety module will activate the configured safe output signal.</p> <p>Please note that this is a monitoring function that does not activate a stopping method after a limit violation.</p>
Safe Monitoring	SSM 	Safe Speed Monitor <p>This function provides a safe output signal to indicate whether the motor speed is below a specified limit. If the speed limit is violated during constant speed monitoring, the safety module will activate the configured safe output signal.</p> <p>Please note that this is a monitoring function that does not activate a stopping method after a limit violation.</p>

8.2.2 Safety Functions Selection

The safety module provides for the selection of up to 16 safety functions including Safe Torque Off (STO). Additionally the user can select "Safe Home Position (SHP)" (see [↪ 'Safe Home Position \(SHP\)'...page 151](#)).



10 Safety Function Slots can be configured and used per SERVOPACK.

The term "Safety Function Slot" in this context defines a set of parameters to select and configure a safety function. A single safety function slot contains a parameter for the input selection, for the function selection, for the output selection and the behavior of the output signal. Additionally, there are parameters to configure the selected safety function.

Safe Torque Off (STO)

Setup Parameters of the Safety Functions

1. → Configure the 7 I/O Ports (Pc0C0...Pc0F0). For more details, see table → [‘Detailed Parameter Description of I/O Configuration Parameters’...page 238](#).



This is only applicable when deploying the SGD7S-OSB02A module!

2. → Select the required safety functions for each slot (1-10) individually from the Configuration I parameters (Pc300 to Pc780). For more details, please refer to → [...page 249](#).
3. → Select the input and output terminal for all selected safety function slots (1-10) from the Configuration I parameters (Pc300 to Pc780) and Configuration II parameters (Pc301-Pc781). For more details, please refer to → [...page 250](#).

8.2.3 Safety Functions Activation

Safety functions (→ [‘Safety Features’...page 86](#)) are activated via

- FSoE with virtual inputs in the high active signal state or
- physical ports in the low active signal state.

Due to the 1oo2 configuration principle, the safety function is active if only one channel is in the low active signal state (→ [‘Digital Input Characteristics and Connections’...page 52](#)).

Activation Input can also be the rising edge of the limit violation of another safety slot. For details, refer to → [‘Output Signal Behavior After a Limit Violation’...page 120](#).

8.3 Safe Torque Off (STO)**Basic Operation**

The Safe Torque Off function (STO) operates based on Safe Torque Off (STO) function that is defined in IEC 61800-5-2. This function shuts OFF the power supply to the motor by executing the HWBB function of the SERVOPACK. The drive cannot generate any hazardous movements. If the STO is activated when the drive is moving, the motor will run down in an uncontrolled manner.

The safe state in the STO function indicates the safe (HWBB) state in which the power supply to the motor has been shut OFF.

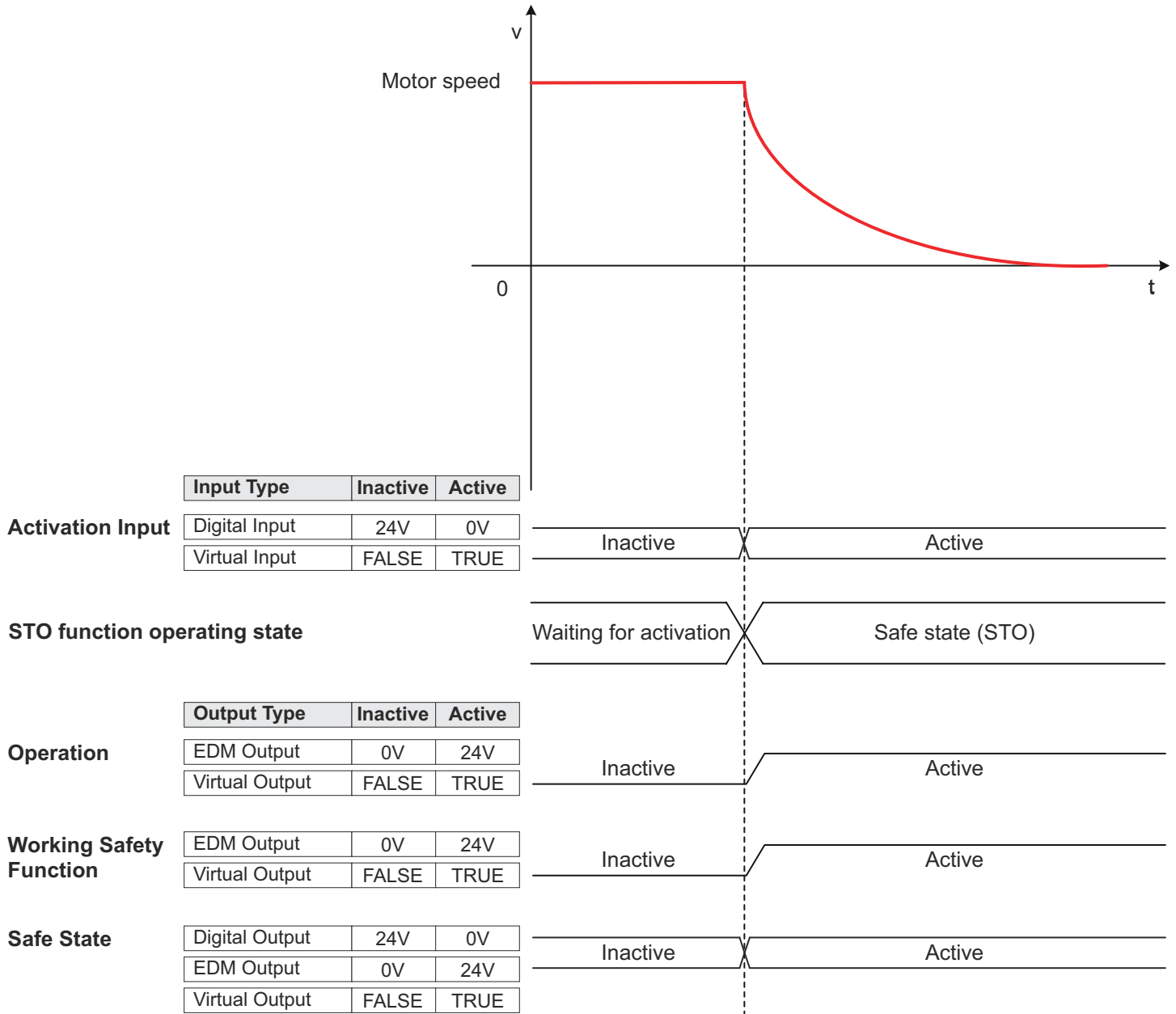

Fig. 52: Safe Torque Off (STO)

WARNING

Incorrect use of the safety function may cause injury

While the HWBB function is operating, the motor may move within an electric angle of 180° or less as a result of a SERVOPACK failure.

- Use the HWBB function for an application only after confirming that movement of the motor will not result in a hazardous condition.

Parameters and Settings

To use the STO function, make the settings for using the STO function of the safety function parameters selection and disable the Active mode.

Activation Method

- Low level on the assigned safe input channel
- TRUE signal on the assigned virtual input over FSoE

Safe Stop 1, Ramp Monitored (SS1-r)

- by detecting an alarm signal from another function that uses STO as a stopping method in case of alarm
- by detecting a failure on the SERVOPACK or safety module.

Return Method

When the SERVOPACK state changes to the safe (HWBB) state by the STO function, the safe (HWBB) state can be cleared to return to normal operation when all of the following conditions are met.

- The input states of the related Activation Input must be inactive.
- The servo ON command must be OFF.
- The polarity detection request must not be input to the SERVOPACK.
- Some utility functions for turning ON the servo must not be executed (such as Jog operation or Auto-tuning ...)

8.4 Safe Stop 1, Ramp Monitored (SS1-r)

Basic Operation

The Safe Stop 1 function with monitored deceleration ramp (SS1-r) monitors the deceleration operation of the motor until the time period specified in the parameter elapses.

With a SS1 function, the drive is brought to a controlled stop and then the power to the motor is safely removed. Once at a standstill, the drive cannot generate any hazardous movements. On gravity-loaded axes, the drive must also be secured by a mechanically-based braking concept.

If the specified speed is exceeded during motor speed monitoring, the power supply to the motor is shut OFF by executing the STO function of the SERVOPACK.

This safety function

- is in accordance with EN 61800-5-2
- corresponds to a controlled stop according IEC 60204-1, stop category 1

By activation, the safety module starts to monitor the deceleration operation of the motor until the time period specified in the parameter elapses, and then shuts OFF the power supply to the motor by executing the HWBB function of the SERVOPACK.

The safe state in the SS1 function indicates the safe (HWBB) state in which the power supply to the motor has been shut OFF.

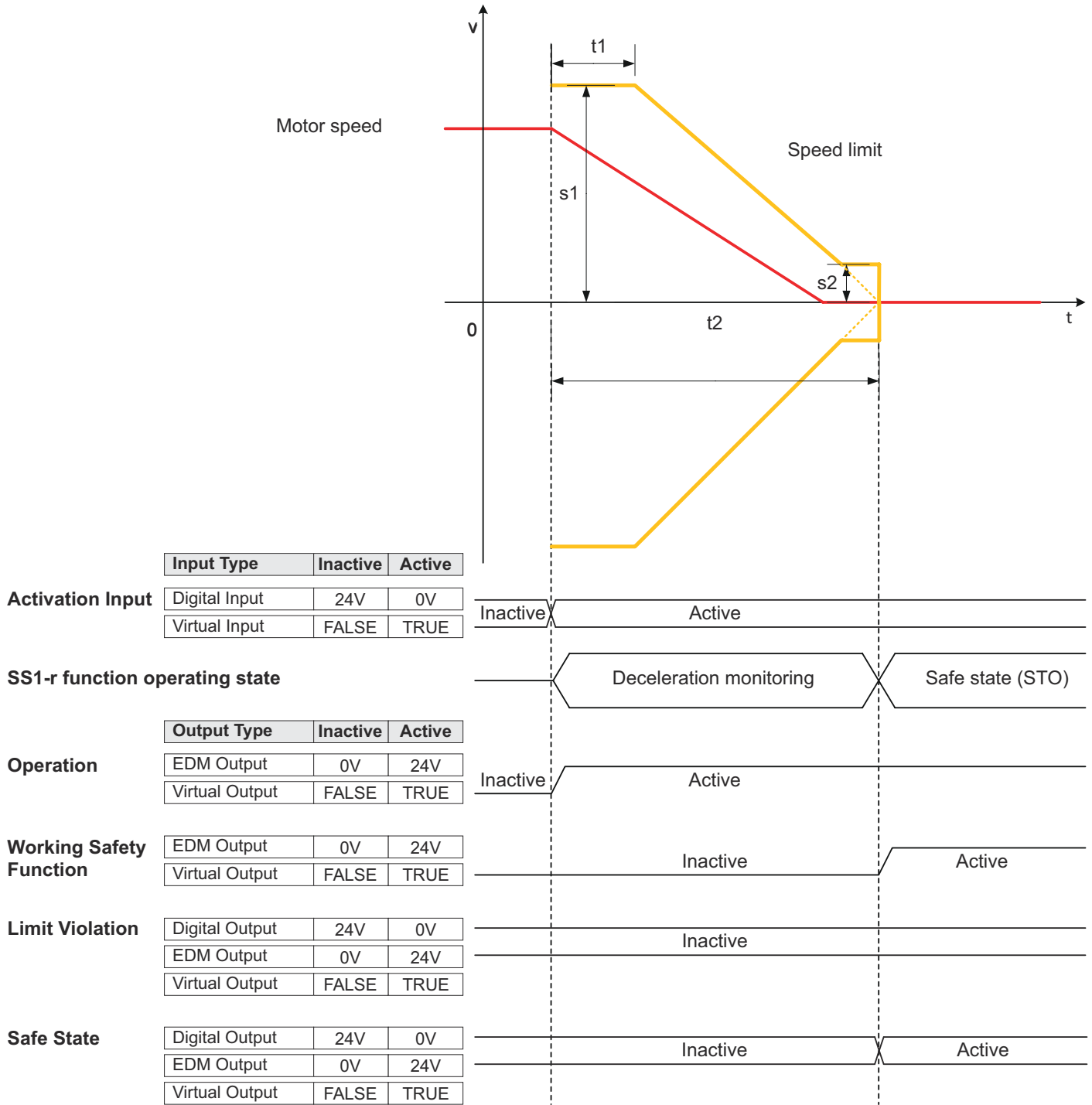

Fig. 53: Safe Stop 1 (SS1-r) With Monitored and Controlled Speed

By activation, the safety module starts to monitor the speed given by parameter $s1$ for the time $t1$. The ramp for deceleration monitoring is calculated from parameters $t1$, $t2$ and $s1$. Parameter $s2$ defines the upper and lower limit value of a zero speed detection window. Within this window the ramp for deceleration monitoring is frozen at $\pm s2$. This allows a speed tolerance of the axis, which is monitored for a violation of $s2$. After time $t2$ has elapsed, the safety module will shut off the motor power supply by activating STO (HWBB). If the speed limit is exceeded before $t2$ elapsed, the safety module will activate STO (HWBB).

The speed limits are bipolar. The speed is monitored independently of the motor run direction.

Safe Stop 1, Time Monitored (SS1-t)

Parameters and Settings

- Waiting Time (t1)
- Monitoring Time (t2)
- Speed Limit 1 (s1)
- Speed Limit 2 (s2)

To use the SS1-r function, make the necessary settings for using this function and configure the related parameters.

Activation Method

- Low level on the assigned safe input channel
- TRUE signal on the assigned virtual input over FSoE
- by detecting an alarm signal from another safety function that uses SS1-r as a stopping method in case of alarm

Return Method

The method of returning to normal operation depends on the operation state of the (SS1-r) function.

1. → During Deceleration Monitoring:

The SERVOPACK will return to normal operation when the input state of the related Activation Input is turned to inactive.

2. → During Safe (HWBB) State:

The method of returning after an alarm has occurred and the SERVOPACK has changed to the safe (HWBB) state is the same as that for the STO function.

8.5 Safe Stop 1, Time Monitored (SS1-t)

Basic Operation

The Safe Stop 1 function with monitored deceleration time (SS1-t) shuts off the motor power supply when the time period specified in the parameter has elapsed.

With a SS1 function, the drive is brought to a controlled stop and then the power to the motor is safely removed. Once at a standstill, the drive cannot generate any hazardous movements. On gravity-loaded axes, the drive must also be secured by a mechanically-based braking concept.

This safety function

- is in accordance with EN 61800-5-2
- corresponds to a controlled stop according IEC 60204-1, stop category 1

By activation, the safety module starts the time t2. After the time t2 has elapsed, the safety module will shut off the motor power supply by activating STO (HWBB).

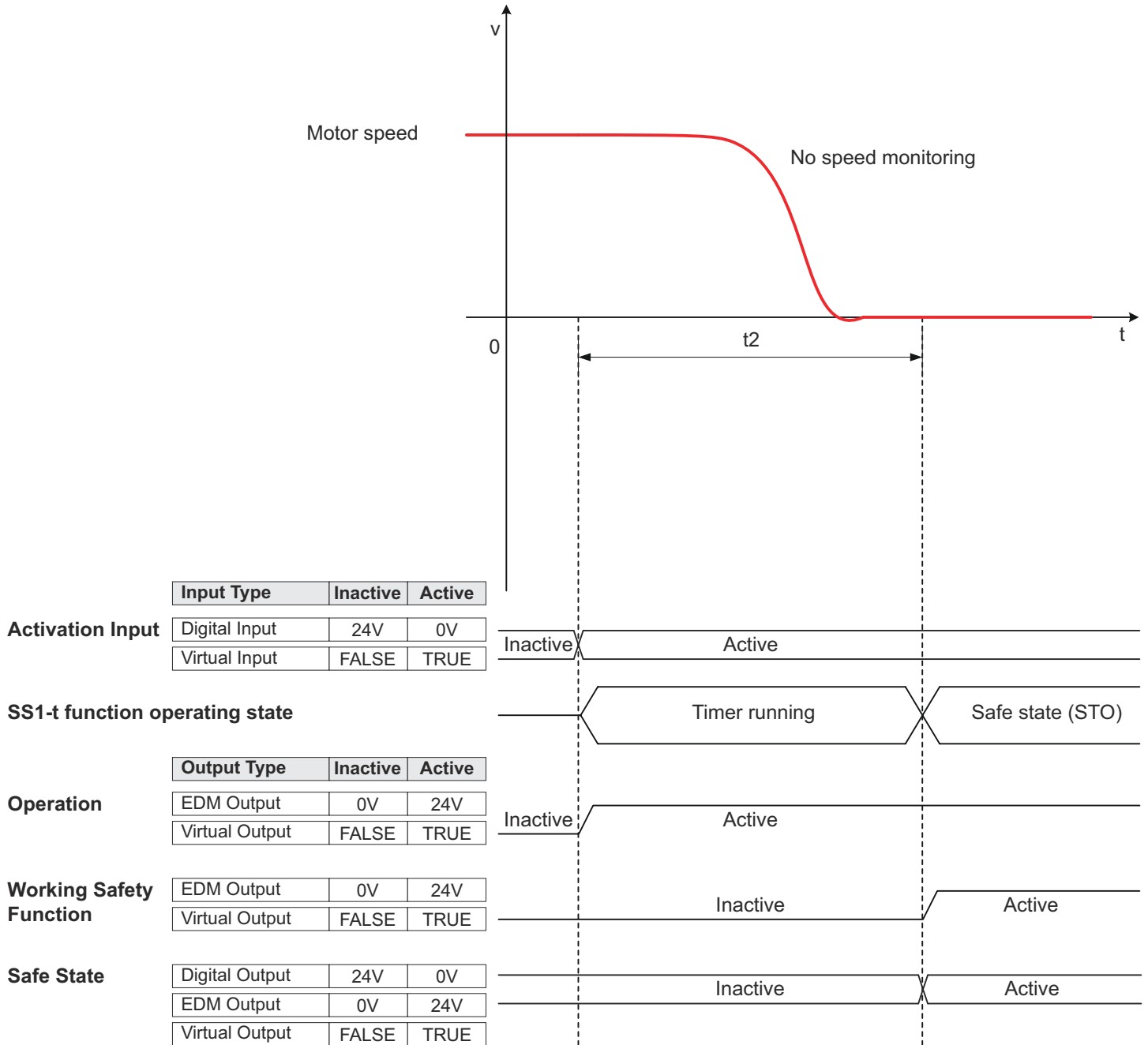

Fig. 54: Safe Stop 1 (SS1-t) Time Monitored

Parameters Monitoring Time (t2)

- Activation Method**
- Low level on the assigned safe input channel
 - TRUE signal on the assigned virtual input over FSoE
 - by detecting a warning signal from another function that uses SS1-t as a stopping method in case of alarm

Return Method The method of returning to normal operation depends on the operation state of the SS1-t function. During timer running, the SERVOPACK will return to normal operation when the input state of the related Activation Input is turned to inactive. The description for returning from safe state (HWBB) can be found in section [↔ 'Safe Torque Off \(STO\)'...page 90.](#)

8.6 Safe Stop 2, Ramp Monitored (SS2-r)

Basic Operation

The Safe Stop 2 function with monitored deceleration ramp (SS2-r) operates based on the Safe Stop 2 (SS2) function that is defined in IEC 61800-5-2. This function monitors the deceleration operation of the motor until the time period specified in the parameter elapses, and then switches to position monitoring and monitors the distance that the motor moved to make sure it is within the allowable range.

With a SS2 function, the drive is brought to a controlled stop and then a SOS is initiated. In a SOS, the drive's control functions are maintained in full.

The HWBB function of the SERVOPACK is executed when the specified speed is exceeded during deceleration monitoring or when the distance that the motor moved exceeds the allowable range during position monitoring. In either case, the power supply to the motor is shut OFF.

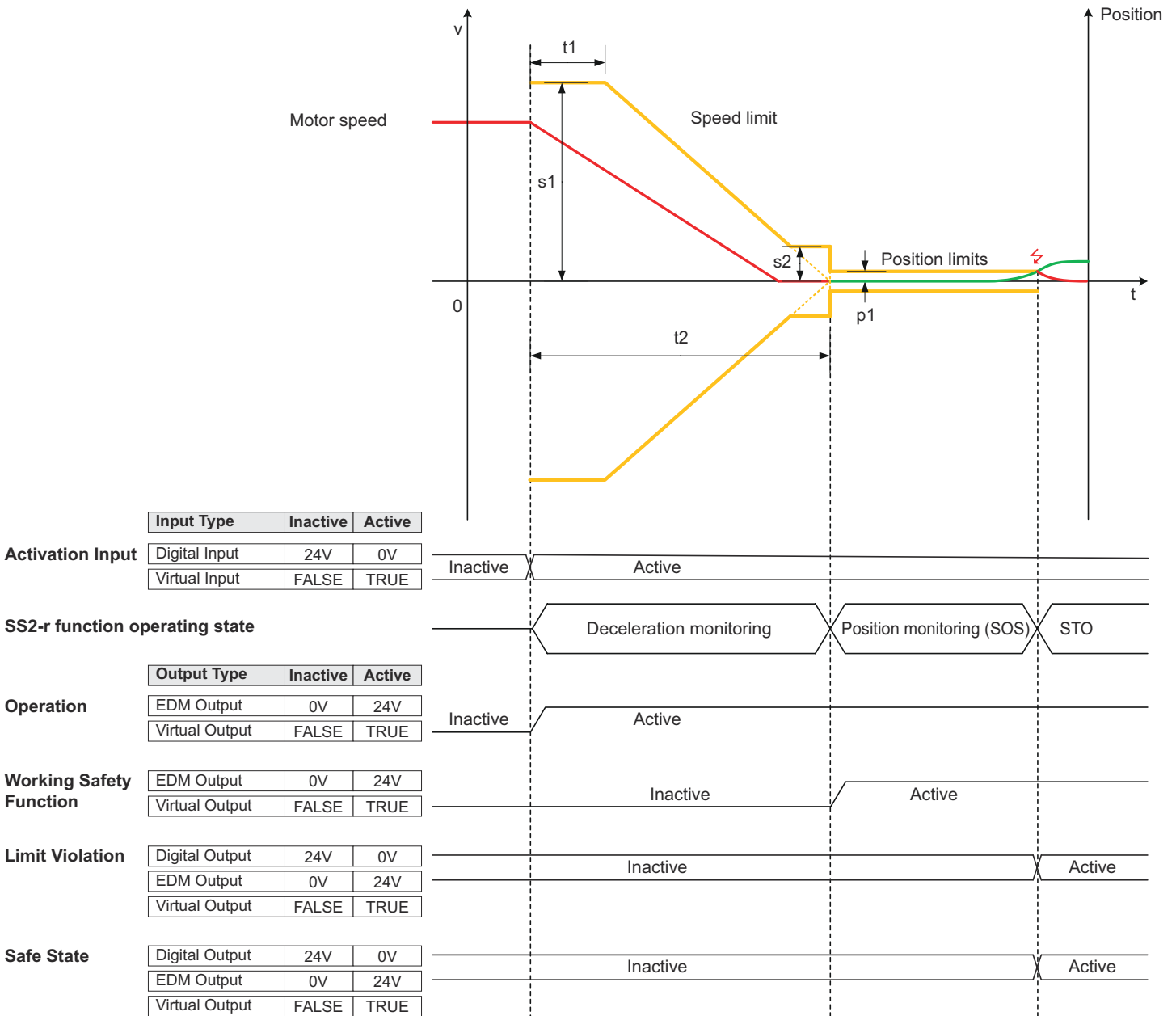

Fig. 55: Safe Stop 2 (SS2-r) Deceleration and Position Monitored

By activation, the safety module starts to monitor the speed given in parameter s_1 for the time t_1 . The ramp for deceleration monitoring is calculated from parameters t_1 , t_2 and s_1 . Parameter s_2 defines the upper and lower limit value of a zero speed detection window. Within this window the ramp for deceleration monitoring is frozen at $\pm s_2$. This allows a speed tolerance of the axis, which is monitored for a violation of s_2 . After time

t2 has elapsed, the safety module will switch from deceleration monitoring to position monitoring. Within this transition, the safety module will latch the actual position and use it as a reference. The safety module will monitor the deviation from the reference position. The deviation limit can be configured with parameter p1.

If any speed limit is violated during deceleration monitoring, the safety module will activate HWBB. If the position deviation exceeds the limit given in p1, the safety module will activate HWBB.

The speed and position limits are bipolar. Speed and position is monitored independent of the motor run direction.

Parameters

- Waiting Time (t1)
- Monitoring Time (t2)
- Speed Limit 1 (s1)
- Speed Limit 2 (s2)
- Distance Limit (p1)

Activation Method

- Low level on the assigned safe input channel
- TRUE signal on the assigned virtual input over FSoE
- by detecting a warning signal from another function that uses SS2-r as a stopping method in case of alarm

Return Method

The method of returning to normal operation depends on the operation state of the SS2-r function. During deceleration monitoring or position monitoring, the SERVOPACK will return to normal operation when the input state of the related Activation Input is turned to inactive. The description for returning from safe state (HWBB) in case of a limit violation can be found in section [↪ 'Safe Torque Off \(STO\)'...page 90](#).

Active Mode

SS2-r could be used in active mode. It controls the motor deceleration and monitors the deceleration operation. Then it switches to monitor the predetermined position. A holding brake cannot be used.

8.7 Safe Stop 2, Time Monitored (SS2-t)

Basic Operation

The Safe Stop 2 function with monitored deceleration time (SS2-t) operates based on the Safe Stop 2 (SS2) function that is defined in IEC 61800-5-2. When the time period specified in the parameter has elapsed, this function switches to position monitoring and monitors the distance that the motor moved to make sure it is within the allowable range. There is no monitoring of the deceleration speed.

With a SS2 function, the drive is brought to a controlled stop and then a SOS is initiated. In a SOS, the drive's control functions are maintained in full.

The HWBB function of the SERVOPACK is executed when the distance that the motor moved exceeds the allowable range during position monitoring and the power supply to the motor is shut OFF.

Safe Stop 2, Time Monitored (SS2-t)

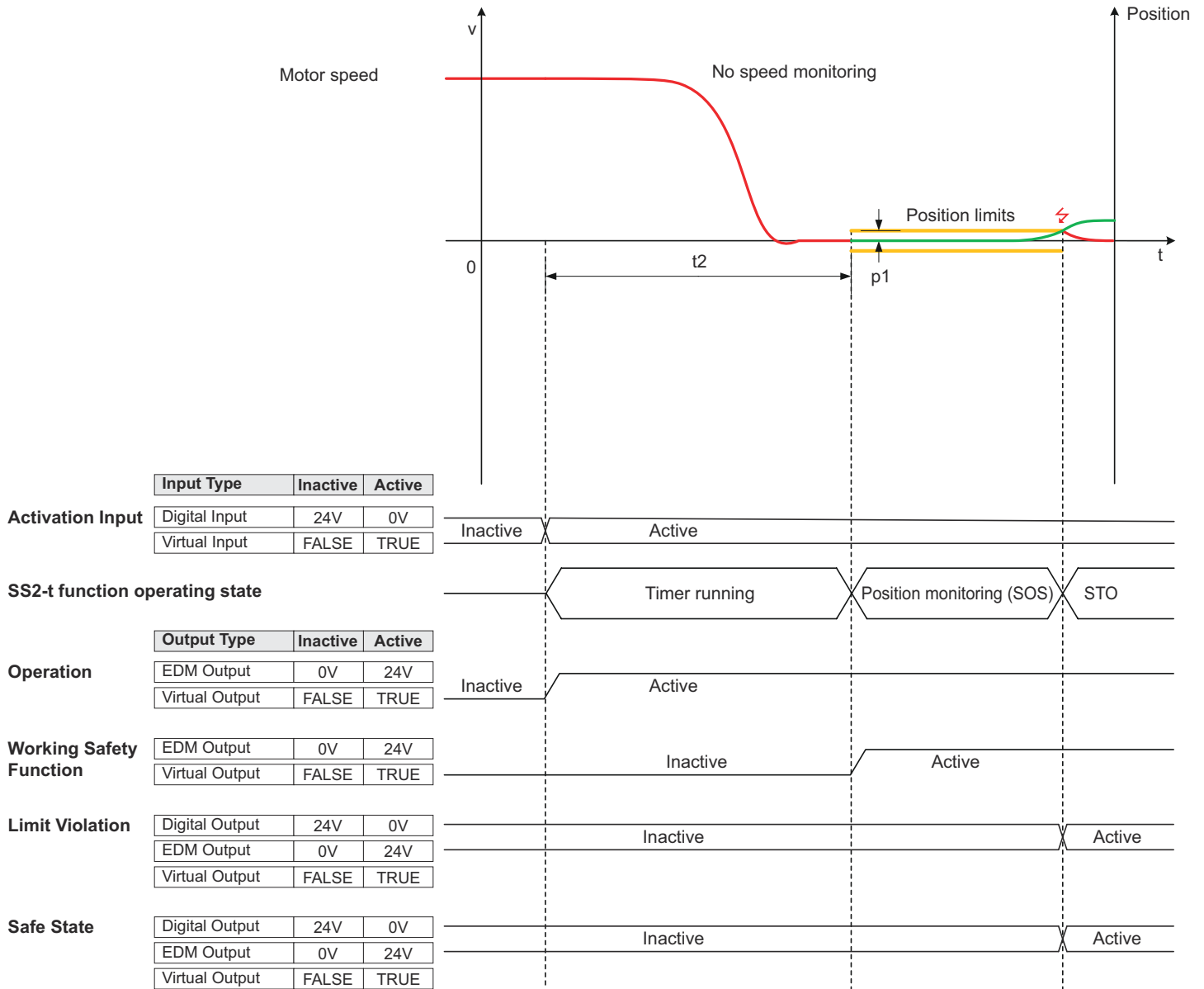

Fig. 56: Safe Stop 2 (SS2-t) Timer Controlled and Position Monitored

By activation, the safety module starts the time t_2 . There is no speed monitoring during this time. After time t_2 has elapsed, the safety module will switch to position monitoring. Within this transition, the safety module will latch the actual position and use it as a reference. The safety module will monitor the deviation from the reference position. The deviation limit can be configured with parameter p_1 .

If the position deviation exceeds the limit given in p_1 , the safety module will activate HWBB.

The position limit is bipolar. The position is monitored independently of the motor run direction.

Parameters

- Monitoring Time (t_2)
- Distance Limit (p_1)

Activation Method

- Low level on the assigned safe input channel
- TRUE signal on the assigned virtual input over FSoE
- by detecting a warning signal from another function that uses SS2-r as a stopping method in case of alarm

Return Method

The method of returning to normal operation depends on the operation state of the SS2-t function. During timer running or position monitoring, the SERVOPACK will return to normal operation when the input state of the related Activation Input is turned to inactive. The description for returning from safe state (HWBB) in case of a limit violation can be found in section → 'Safe Torque Off (STO)'...page 90.

8.8 Safe Operating Stop (SOS)**Basic Operation**

The Safe Operating Stop (SOS) operates based on the SOS function that is defined in IEC 61800-5-2. This function monitors the distance that the motor moved to make sure it is within the allowable range. The drive's control functions are maintained in full.

The HWBB function of the SERVOPACK is executed when the distance that the motor moved exceeds the allowable range during position monitoring and shuts OFF the power supply to the motor. On gravity-loaded axes, the drive must also be secured by a mechanically-based braking concept.

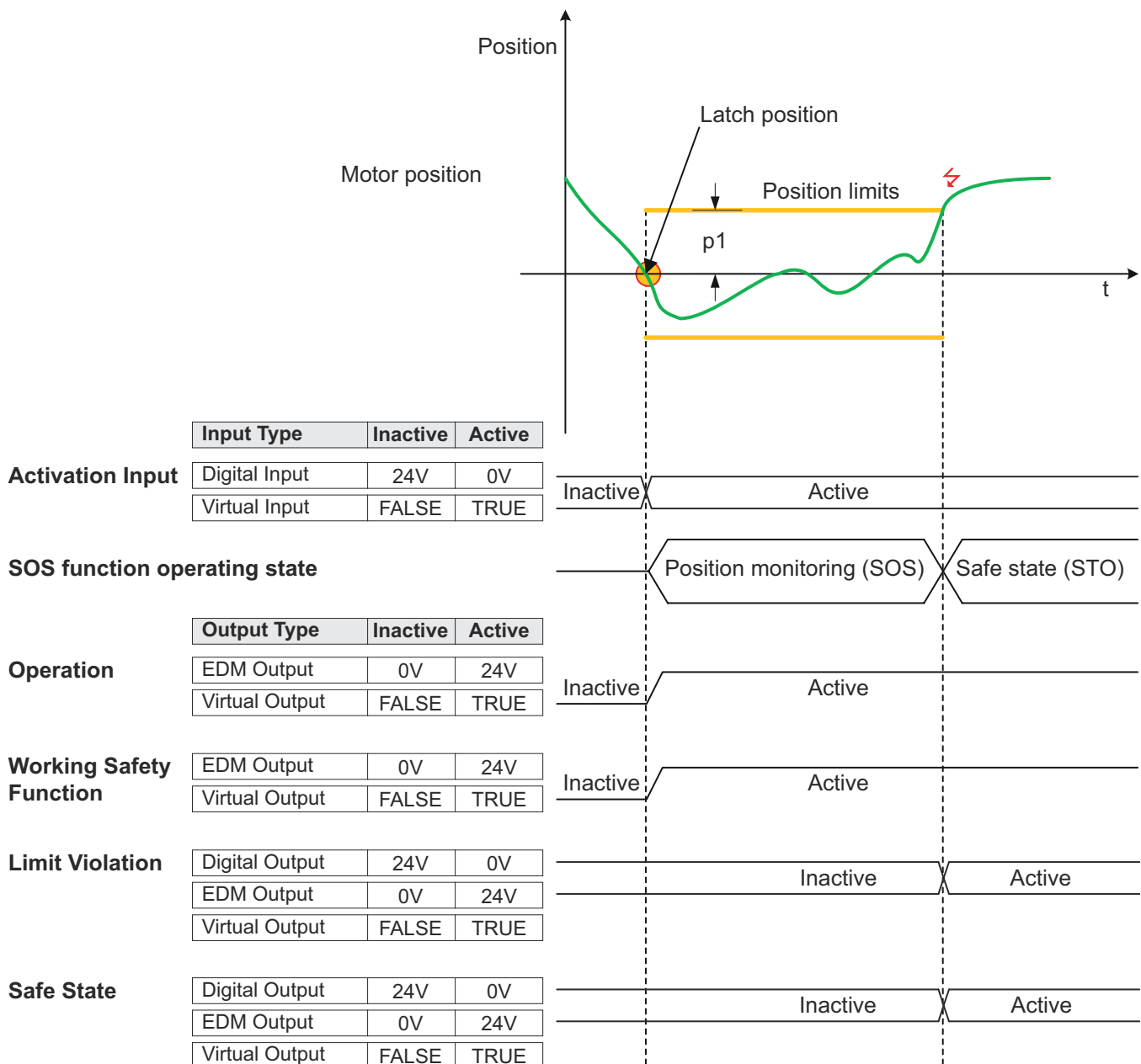

Fig. 57: Safe Operating Stop (SOS)

Safely Limited Speed (SLS)

By activation, the safety module will switch to position monitoring. Within this transition, the safety module will latch the actual position and use it as a reference. The safety module will monitor the deviation from the reference position. The deviation limit can be configured with parameter p1. If the position deviation exceeds the limit given in p1, the safety module will activate STO.

Parameters

- Distance Limit (p1)

Activation Method

- Low level on the assigned safe input channel
- TRUE signal on the assigned virtual input over FSoE
- by activation of Safety Function SS2-r and SS2-t

Return Method

The method of returning to normal operation depends on the operation state of the SOS function. During position monitoring, the SERVOPACK will return to normal operation when the input state of the related Activation Input is turned to inactive. The description for returning from safe state (HWBB) in case of a limit violation can be found in section [↪ 'Safe Torque Off \(STO\)'...page 90](#).

8.9 Safely Limited Speed (SLS)

Basic Operation

The Safely Limited Speed (SLS) function monitors the drive to check that a defined maximum speed is not exceeded. If the speed limit value is exceeded, the drive is shut down safely.

This function operates based on Safely Limited Speed (SLS) that is defined in IEC 61800-5-2. It monitors the deceleration operation of the motor until the time period specified in the parameter elapses, and then monitors the motor speed to make sure it is within the allowable range.

If the specified speed is exceeded during motor speed monitoring, the selected stopping safety function will be activated.

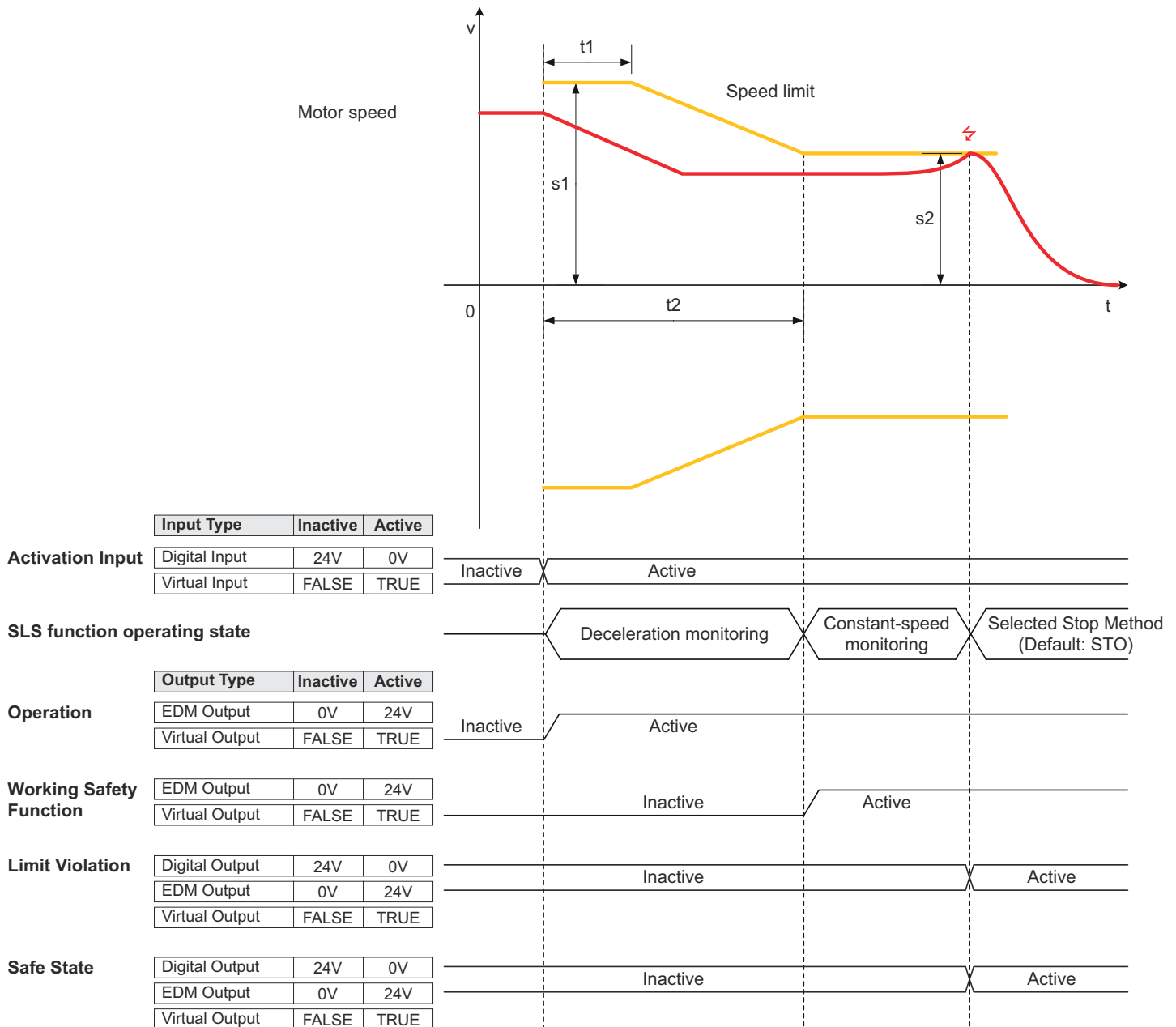

Fig. 58: Safely Limited Speed (SLS)

By activation, the safety module starts to monitor the speed after time delay (t_1) and compares it to the limit given in parameter s_1 for the time t_2 . The ramp for deceleration monitoring down to speed s_2 is calculated from parameters t_1 , t_2 , s_1 and s_2 . After time t_2 has elapsed, the safety module will switch from deceleration monitoring to constant speed monitoring. This operating state will be maintained until the safety request is taken back to normal operation.

If any speed limit is violated during deceleration monitoring or constant speed monitoring, the selected stopping function, i.e. STO (default), SS1-r, SS1-t, SS2-r or SS2-t will be activated.

Parameters

- Waiting Time (t_1)
- Monitoring Time (t_2)
- Speed Limit 1 (s_1)
- Speed Limit 2 (s_2)

Safely Limited Acceleration (SLA)

- Activation Method**
- Low level on the assigned safe input channel
 - TRUE signal on the assigned virtual input over FSoE

Return Method The method of returning to normal operation depends on the operation state of the SLS function. During deceleration monitoring and constant speed monitoring, the SERVOPACK will return to normal operation when the input state of the related Activation Input is turned to inactive. The description for returning from safe state (HWBB) in case of a limit violation can be found in section → ‘Safe Torque Off (STO)’...page 90.

8.10 Safely Limited Acceleration (SLA)

Basic Operation The Safely Limited Acceleration (SLA) function monitors the acceleration operation of the motor. If the specified acceleration speed is exceeded during the acceleration speed monitoring, the selected motor stopping method will be applied, for example STO, which will shut OFF the power supply to the motor.

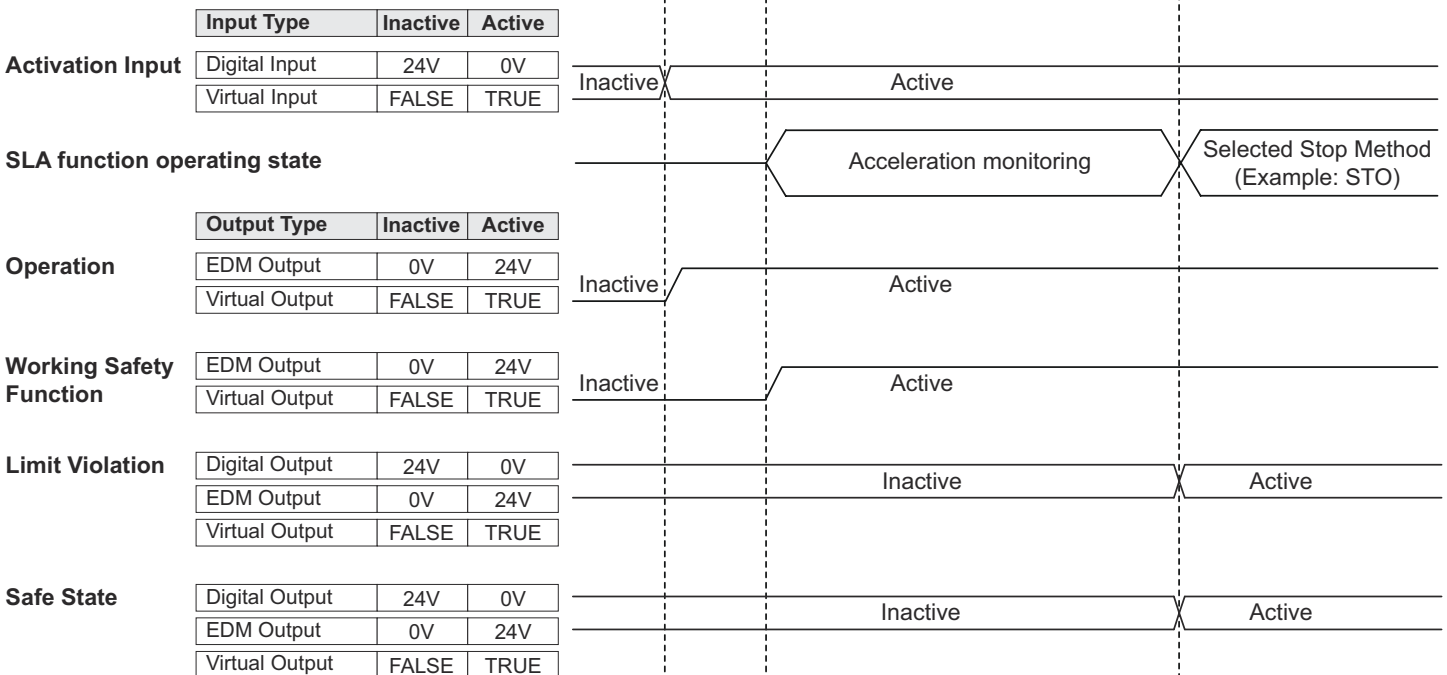
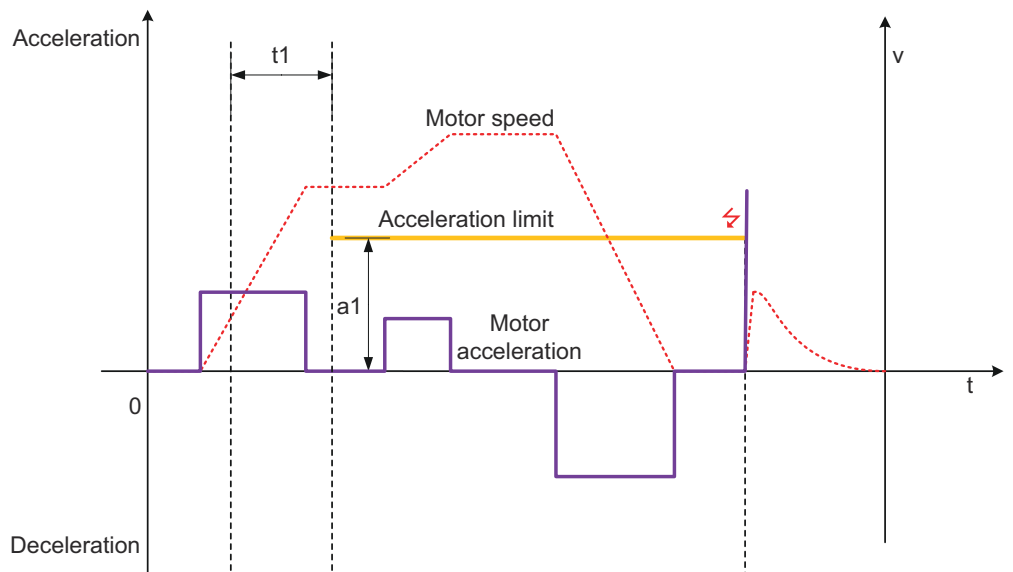

Fig. 59: Safely Limited Acceleration (SLA)

By activation, the safety module starts to monitor the acceleration and compares it to the limit given in parameter a1. This operating state will be maintained until the safety request is taken back to normal operation.

If the acceleration limit is violated, the selected stopping function, i.e. STO (default), SS1-r, SS1-t, SS2-r or SS2-t will be activated.

The acceleration limit a1 is **not** bipolar. If the user wants to monitor a deceleration, he must enter a negative value to parameter a1.

Parameters

- Waiting Time (t1)
- Acceleration Limit (a1)

Activation Method

- Low level on the assigned safe input channel
- TRUE signal on the assigned virtual input over FSoE

Return Method

The method of returning to normal operation depends on the operation state of the SLA function. During acceleration monitoring, the SERVOPACK will return to normal operation when the input state of the related Activation Input is turned to inactive. The description for returning from safe state (HWBB) in case of a limit violation can be found in section [↪ 'Safe Torque Off \(STO\)'...page 90.](#)

8.11 Safe Speed Range (SSR)

Basic Operation

The SSR function operates based on Safe Speed Range (SSR) defined in IEC 61800-5-2. It adds minimum speed monitoring to the SLS function. In other words, the maximum speed must not exceed a certain value, and the minimum speed must not drop below a certain value. If either of these limits is violated, the drive is shut down.

This safety function can be used to monitor a safe minimum speed, as well as an upper limit Safe Speed Range (SSR). It can generally be used for permanent process monitoring.

Risks cannot always be eliminated by limiting the capacity for speeds to suddenly increase. Speeds that reduce suddenly due to an error can also present a risk. If axes are operating at a defined distance, a speed that drops abruptly on just one of the two axes may create a risk of crushing. SSR would be used to shut down the relevant axes, eliminating any hazard to the machine operator.

Safe Speed Range (SSR)

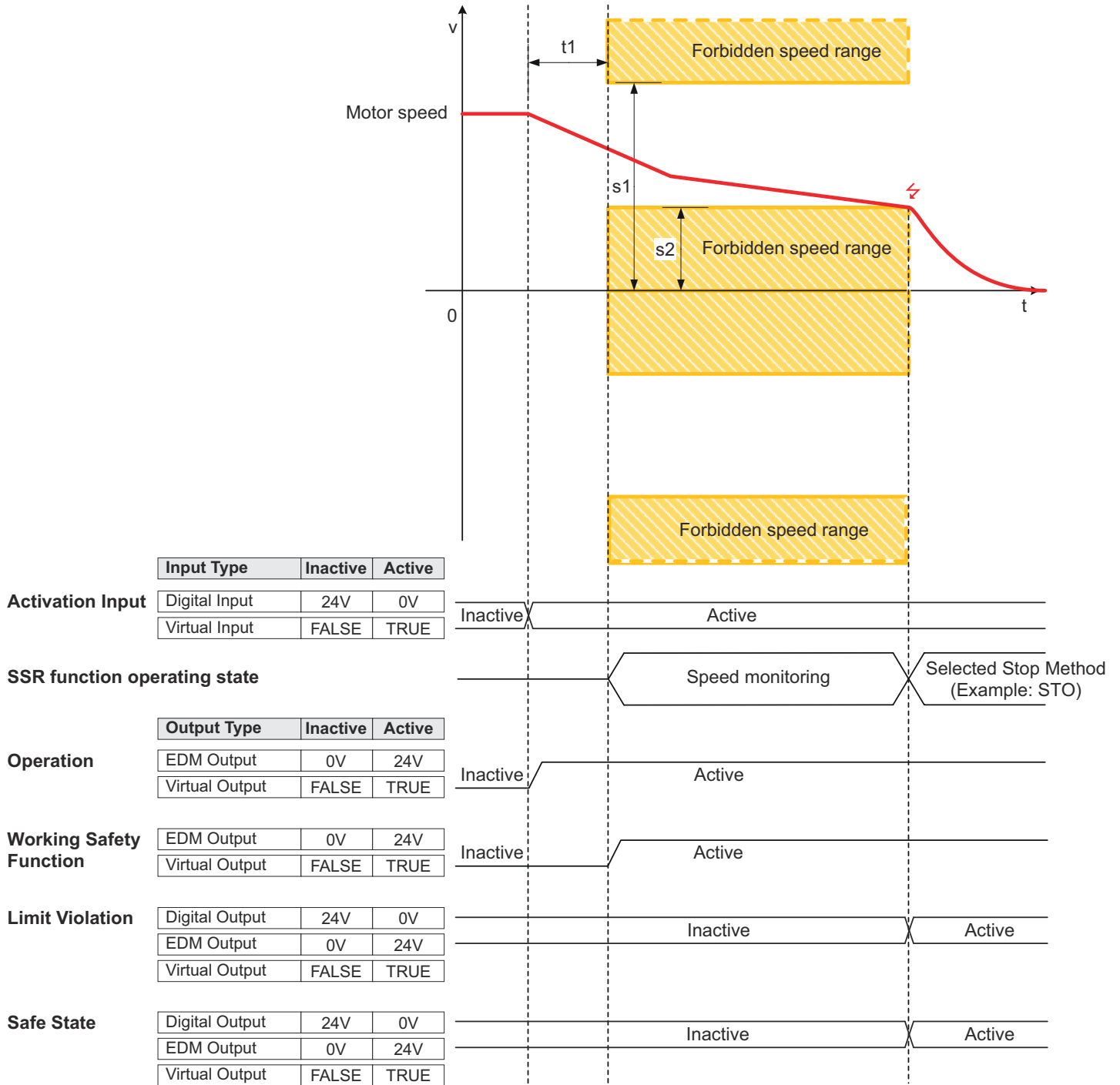

Fig. 60: Safe Speed Range (SSR)

By activation, the safety module starts to monitor the speed and compare it to the limits given in parameter s_1 and s_2 . This operating state will be kept until the safety request is taken back to normal operation.

If any speed limit is violated during deceleration monitoring or constant speed monitoring, the selected stopping function, i.e. STO (default), SS1-r, SS1-t, SS2-r or SS2-t will be activated.

The speed limits are bipolar. The speed is monitored independent of the motor run direction.

Parameters

- Waiting Time (t1)
- Speed Limit 1 (s1)
- Speed Limit 2 (s2)

Activation Method

- Low level on the assigned safe input channel
- TRUE signal on the assigned virtual input over FSoE

Return Method

The method of returning to normal operation depends on the operation state of the SSR function. During speed monitoring, the SERVOPACK will return to normal operation when the input state of the related Activation Input is turned to inactive. The description for returning from safe state (HWBB) in case of a limit violation can be found in section [↪ 'Safe Torque Off \(STO\)'...page 90](#).

8.12 Safe Direction (SDI)

Basic Operation

The SDI function operates based on Safe Direction (SDI) defined in IEC 61800-5-2. This prevents the motor from moving in an invalid direction, it can only move in one (defined) direction. If the specified direction is violated, the drive is shut down safely.

Safe Direction (SDI)

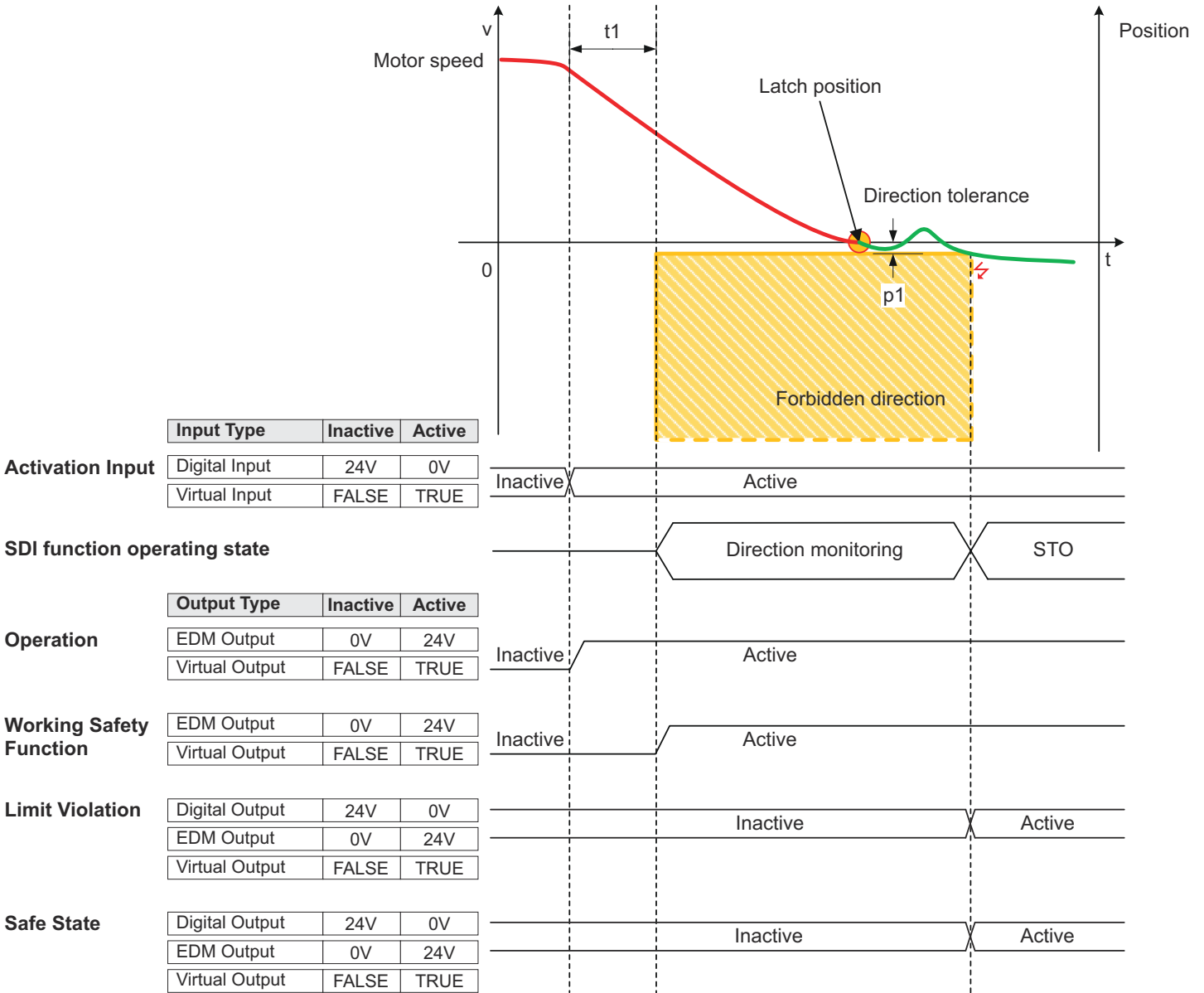

Fig. 61: Safe Direction (SDI)

This safety function is frequently used in combination with safely limited speed (SLS) in setup mode. Here too, the drive-integrated solution enables the fastest possible shut-down.

By activation, the safety module starts to monitor the motor shaft direction. In case of a movement in the forbidden direction, the actual position will be latched and compared to the limit given in parameter p1. By giving a sign to the position limit p1, the user defines the forbidden direction. This operating state will be kept until the safety request is taken back to normal operation.

If the position limit is violated, the safety module will activate STO.

The position limit is **not** bipolar. The position is monitored in the forbidden direction only.

Parameters

- Waiting Time (t1)
- Distance Limit (p1)

Activation Method

- Low level on the assigned safe input channel
- TRUE signal on the assigned virtual input over FSoE

Return Method

The method of returning to normal operation depends on the operation state of the SDI function. During direction monitoring, the SERVOPACK will return to normal operation when the input state of the related Activation Input is turned to inactive. The description for returning from safe state (HWBB) in case of a limit violation can be found in section → [‘Safe Torque Off \(STO\)’...page 90](#).

8.13 Safely Limited Position (SLP)

Successful execution of the Safe Home Position (SHP) function is a precondition for the use of Safely Limited Position (SLP).

Basic Operation

The SLP function operates based on Safely Limited Position (SLP) that is defined in IEC 61800-5-2. It monitors the end positions of previously defined ranges. If a limit value is violated, the drive is shut down safely.

Safe position monitoring ensures that the motor does not exceed a pre-set position limit value. If a limit value is violated, the motor is braked using the selected safe stop method. The stopping performance achievable from a technical point of view must be taken into account. Below the limit value there are no restrictions in terms of acceleration or speed of the motor. Absolute position detection is required for this safety function. Absolute encoders may be used or relative measuring systems may be combined with a safe reference run.

Safely Limited Position (SLP)

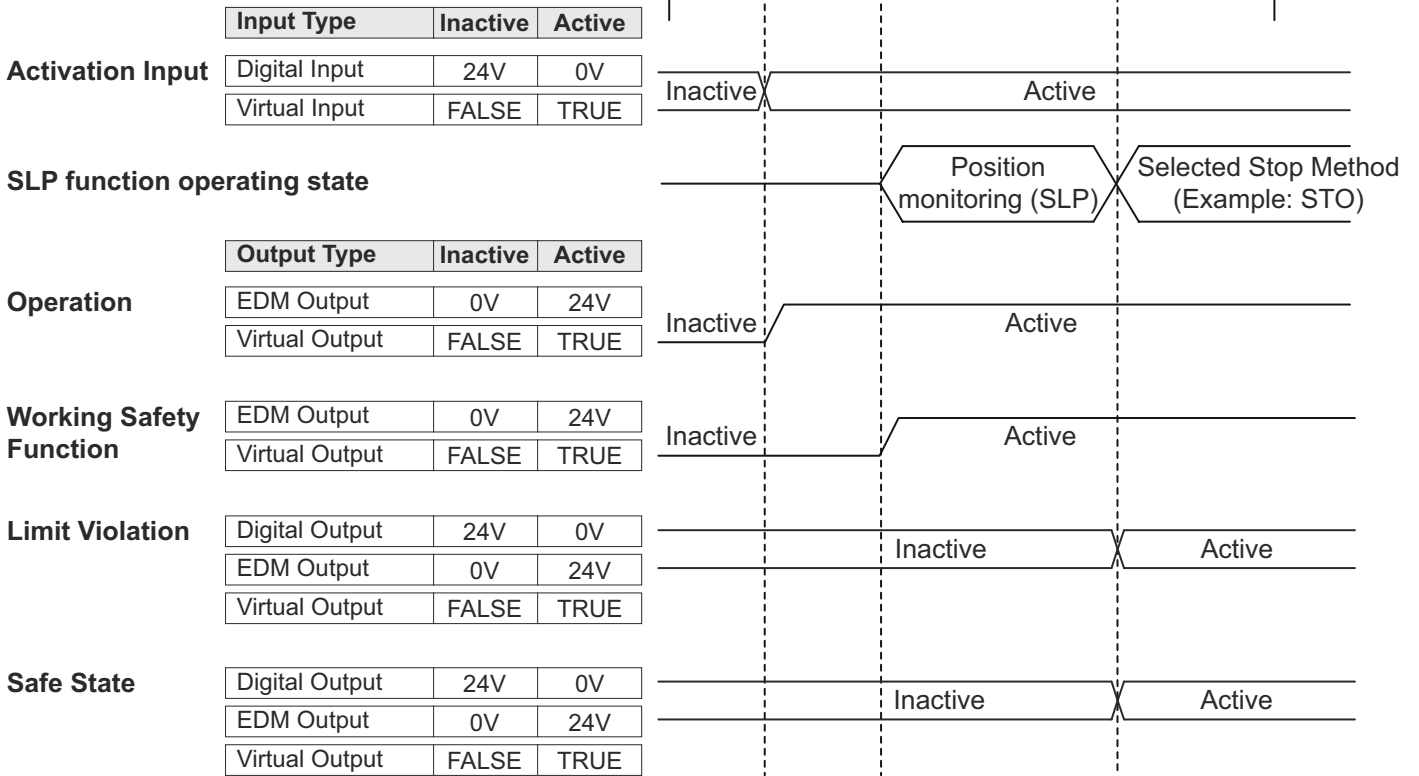
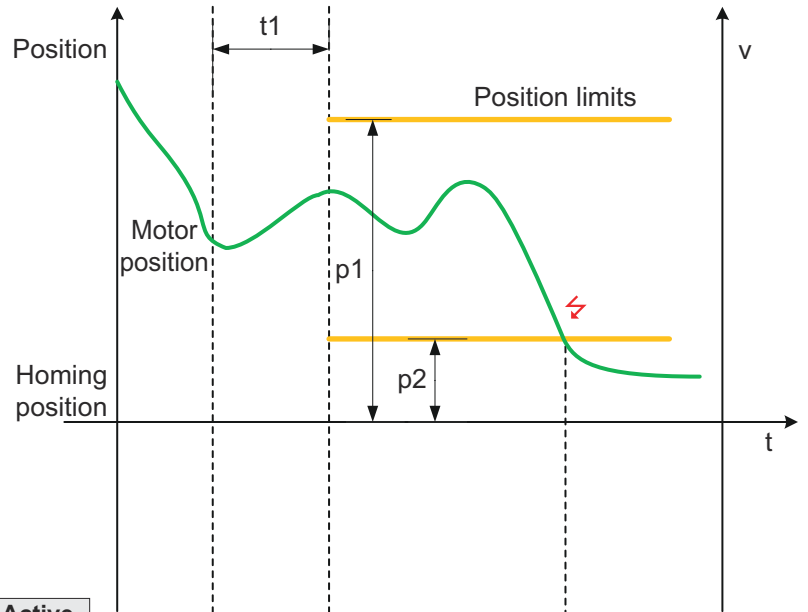

Fig. 62: Safely Limited Position (SLP)

By activation, the safety module will monitor the actual position and compare it to the position limits p1 and p2. If the actual position exceeds the limits, the selected stopping function, i.e. STO (default), SS1-r, SS1-t, SS2-r or SS2-t will be activated.

The position is monitored independently of the motor run direction.

When using an incremental encoder, the position limits have to be calculated considering a position overflow.

Parameters

- Waiting Time (t1)
- Distance Limit (p1)
- Distance Limit (p2)

Activation Method

- Low level on the assigned safe input channel
- TRUE signal on the assigned virtual input over FSoE

Return Method

The method of returning to normal operation depends on the operation state of the SLP function. During position monitoring, the SERVOPACK will return to normal operation when the input state of the related Activation Input is turned to inactive. The description for returning from safe state (HWBB) in case of a limit violation can be found in section → *'Safe Torque Off (STO)'...page 90.*

8.14 Safely Limited Increment (SLI)

Basic Operation

The SLI function operates based on Safely Limited Increment (SLI) defined in IEC 61800-5-2. It monitors the movements of the drive for compliance with a defined increment. The reference position is defined when monitoring is activated. If a limit value is violated, the drive is shut down safely.

The motor is allowed to travel a permitted distance after a start command. A safe stop function must be triggered once the limit value is reached. If the permitted distance is exceeded, the drive must be safely brought to a standstill. Encoder systems with relative measurement are sufficient for this safety function.

Safely Limited Increment (SLI)

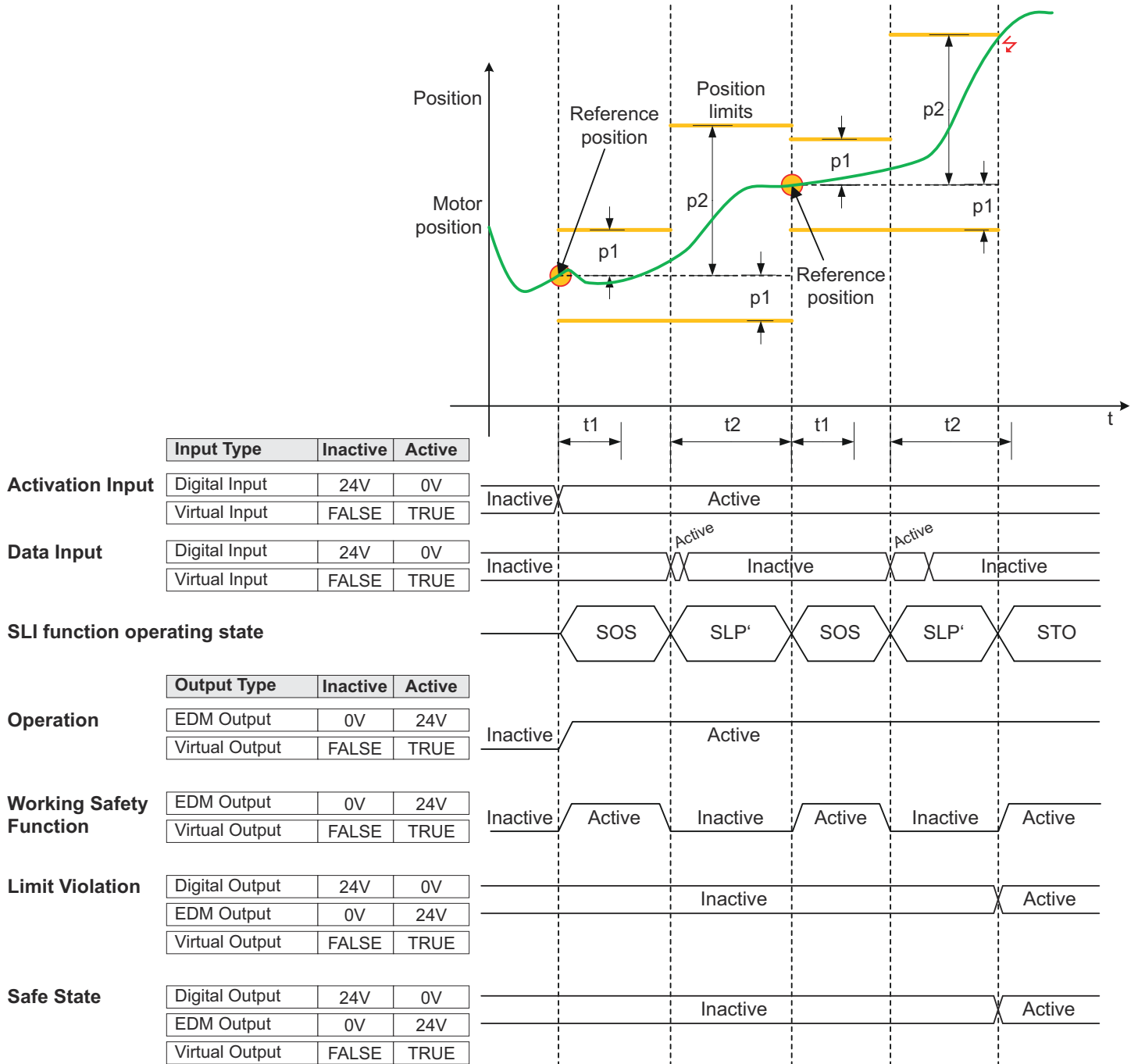

Fig. 63: Safely Limited Increment (SLI)

By activation, the safety module will monitor the actual position and compare it to the distance limits p1 and p2. If the actual position exceeds the limits, depending on the active subfunction STO or the selected stopping function will be activated:

- SOS: STO will be activated.
- SLP: the selected stopping function, i.e. STO (default), SS1-r, SS1-t, SS2-r or SS2-t will be activated.

Parameters

- Waiting Time (t1)
- Monitoring Time (t2)
- Distance Limit (p1)
- Distance Limit (p2)

Activation Method

- Low level on the assigned safe input channel
- TRUE signal on the assigned virtual input over FSoE

Return Method

The method of returning to normal operation depends on the operation state of the SLI function. During position monitoring, the SERVOPACK will return to normal operation when the input state of the related Activation Input is turned to inactive. The description for returning from safe state (HWBB) in case of a limit violation can be found in section [↪ 'Safe Torque Off \(STO\)'...page 90](#).

8.15 Safely Limited Torque (SLT)

Basic Operation

Torque measuring systems are not widely used on standard drives. Some servo drives technology provides the option for indirect measurement via the motor current. The safety module provides a safe analog input and a non-safe analog input to attach an external safe torque sensor to it.

Safely Limited Torque (SLT)

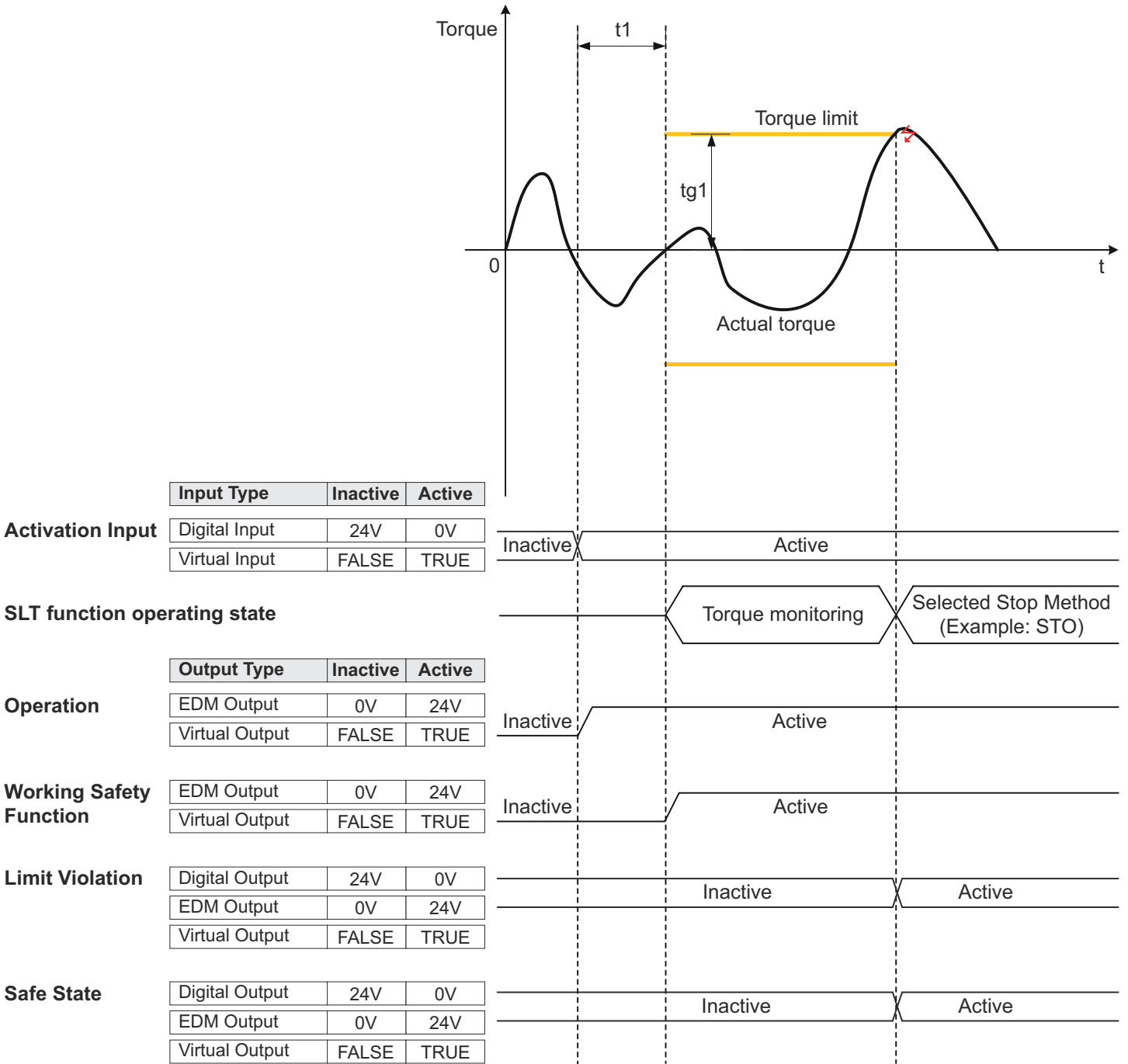

Fig. 64: Safely Limited Torque (SLT)

By activation, the safety module starts to monitor the torque and compare it to the limit given in parameter tq_1 . This operating state will be kept until the safety request is taken back to normal operation.

If the torque limit is violated, the selected stopping function, i.e. STO (default), SS1-r, SS1-t, SS2-r or SS2-t will be activated.

The torque limit tq_1 is bipolar. The torque is monitored independently of the motor run direction.

The safety module receives the torque signal from an external sensor that is attached to the shaft. These sensors have to provide an output signal that can be processed by the analog input channels of the safety module:

- Port F1, F2: Safe Analog Input (0 - 10 V)
- Port G1: Non-Safe Analog Input (4 - 20 mA)

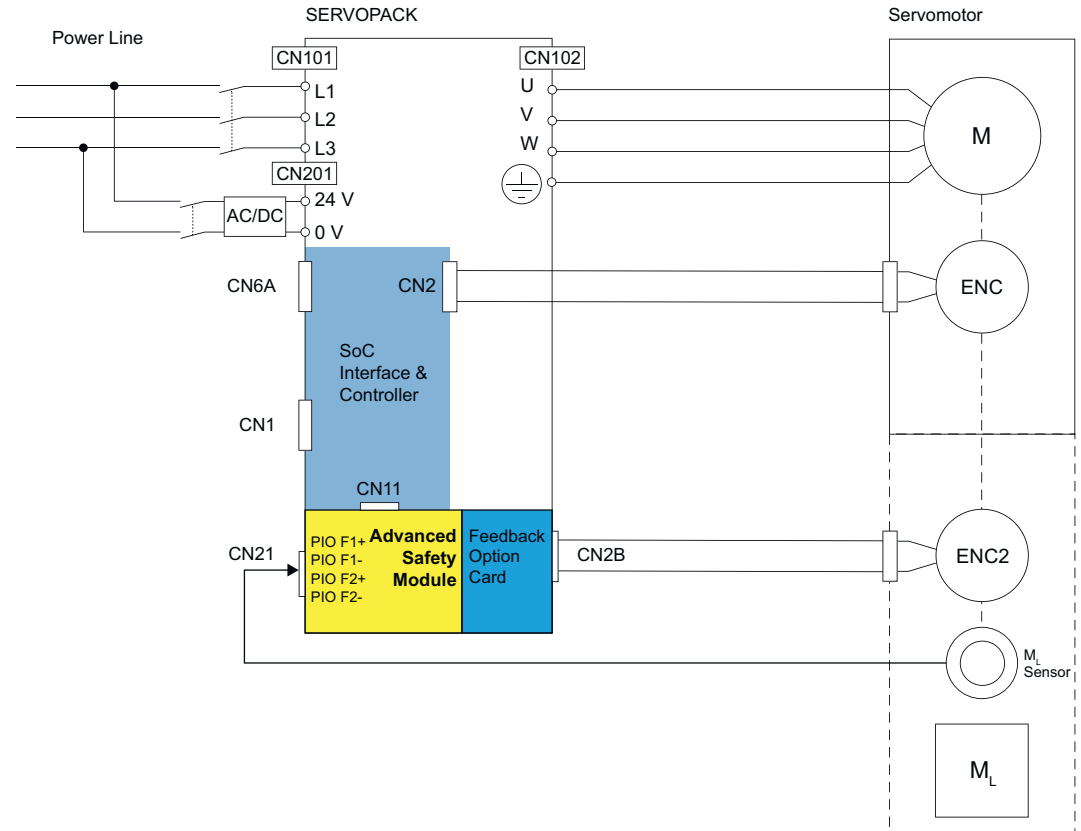

Fig. 65: SLT block diagram with torque sensor

Parameters

- Waiting Time (t1)
- Torque Limit (tq1)

Activation Method

- Low level on the assigned safe input channel
- TRUE signal on the assigned virtual input over FSoE

Return method

The method of returning to normal operation depends on the operation state of the SLT function. During torque monitoring, the SERVOPACK will return to normal operation when the input state of the related Activation Input is turned to inactive. The description for returning from safe state (HWBB) in case of a limit violation can be found in section [↪ 'Safe Torque Off \(STO\)'...page 90.](#)



Please consider the tolerance of the analog input channel when selecting the torque limit value.

8.16 Safe Motor Temperature (SMT)

Basic Operation

This function prevents the motor temperature from exceeding a specified upper limit.



If an EDM output (non-safe) is configured for the output signal type, the configured output signal is also non-safe.

Safe Motor Temperature (SMT)

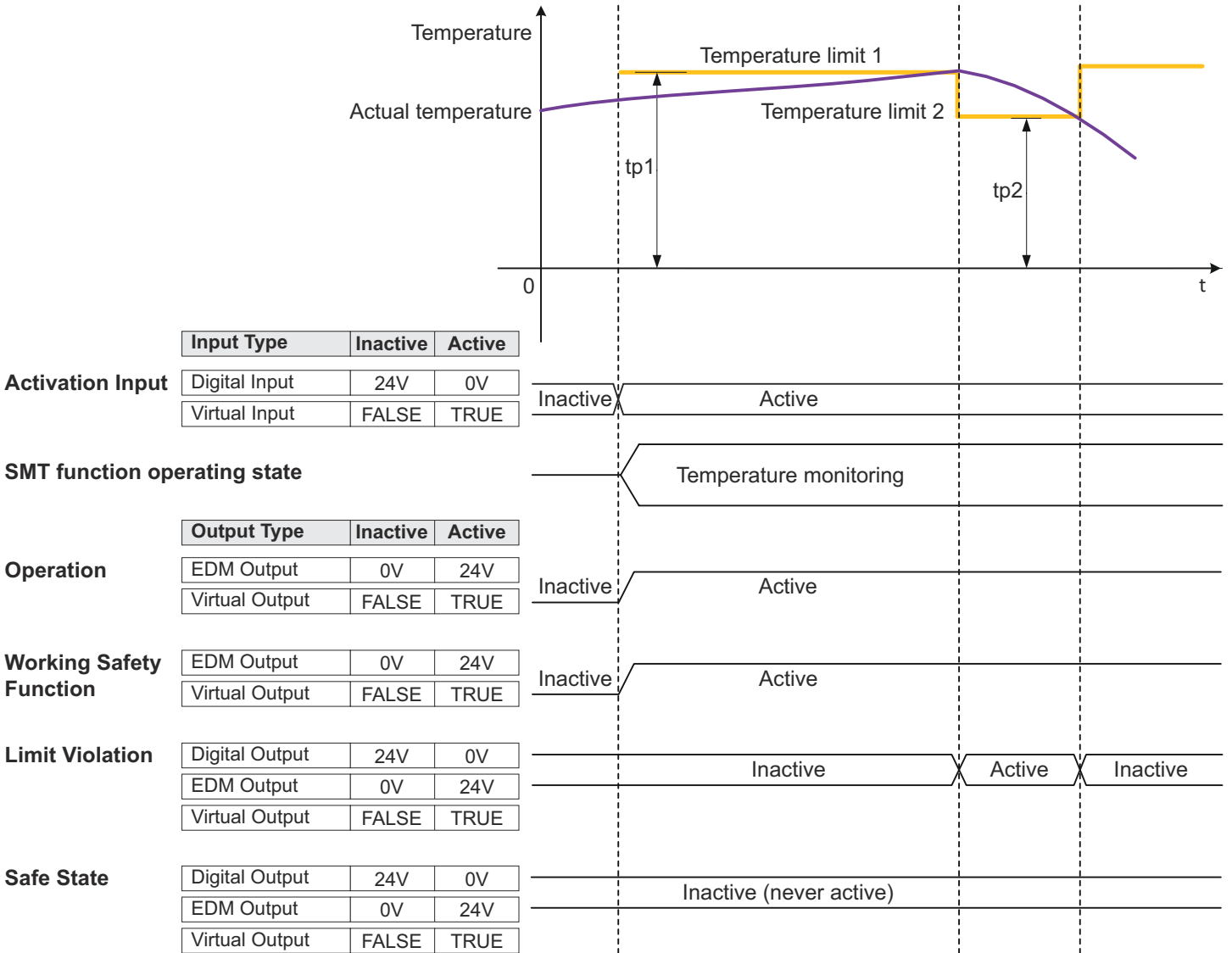

Fig. 66: Safe Motor Temperature (SMT)

By activation, the safety module starts to monitor the temperature and compares it to the limit given in parameter tp1. This operating state will be kept until the safety request is taken back to normal operation.

If the upper temperature limit tp1 is violated the safety module will deactivate the assigned output.

If the lower temperature limit tp2 is reached the safety module will activate the assigned output.

The safety module receives the temperature signal from an external sensor that is attached to the motor housing. These sensors have to provide an output signal that can be processed by the analog input channels of the safety module:

- Port F1, F2: Safe Analog Input (0 - 10 V)
- Port G1: Non-Safe Analog Input (4 - 20 mA)
- Port G2: Non-Safe Analog Input for PT1000

Parameters

- Temperature Limit (tp1)
- Temperature Limit (tp2)

Activation Method

- Low level on the assigned safe input channel
- TRUE signal on the assigned virtual input over FSoE

Return Method

There is no change of the SERVOPACK operating state.



Please consider the tolerance of the analog input channel when selecting the temperature limit values.

8.17 Safe Cam (SCA)

Successful execution of the Safe Home Position (SHP) function is a precondition for the use of Safe Cam (SCA).

Basic Operation

This function provides a safe output signal to indicate whether the motor shaft position is within a specified range.



If an EDM output (non-safe) is configured for the output signal type, the configured output signal is also non-safe.

By activation, the safety module will monitor the actual position after the time t_1 and compare it to the position limits p_1 and p_2 . If the actual position exceeds the limits, the safety module will activate the configured output signal. To avoid a flickering of this output signal, a hysteresis (p_3) for the position limits becomes active. The safe output signal will be deactivated if the actual position returns to the area between the limits p_1-p_3 and p_2+p_3 .

The position is monitored independently of the motor run direction.

Safe Cam (SCA)

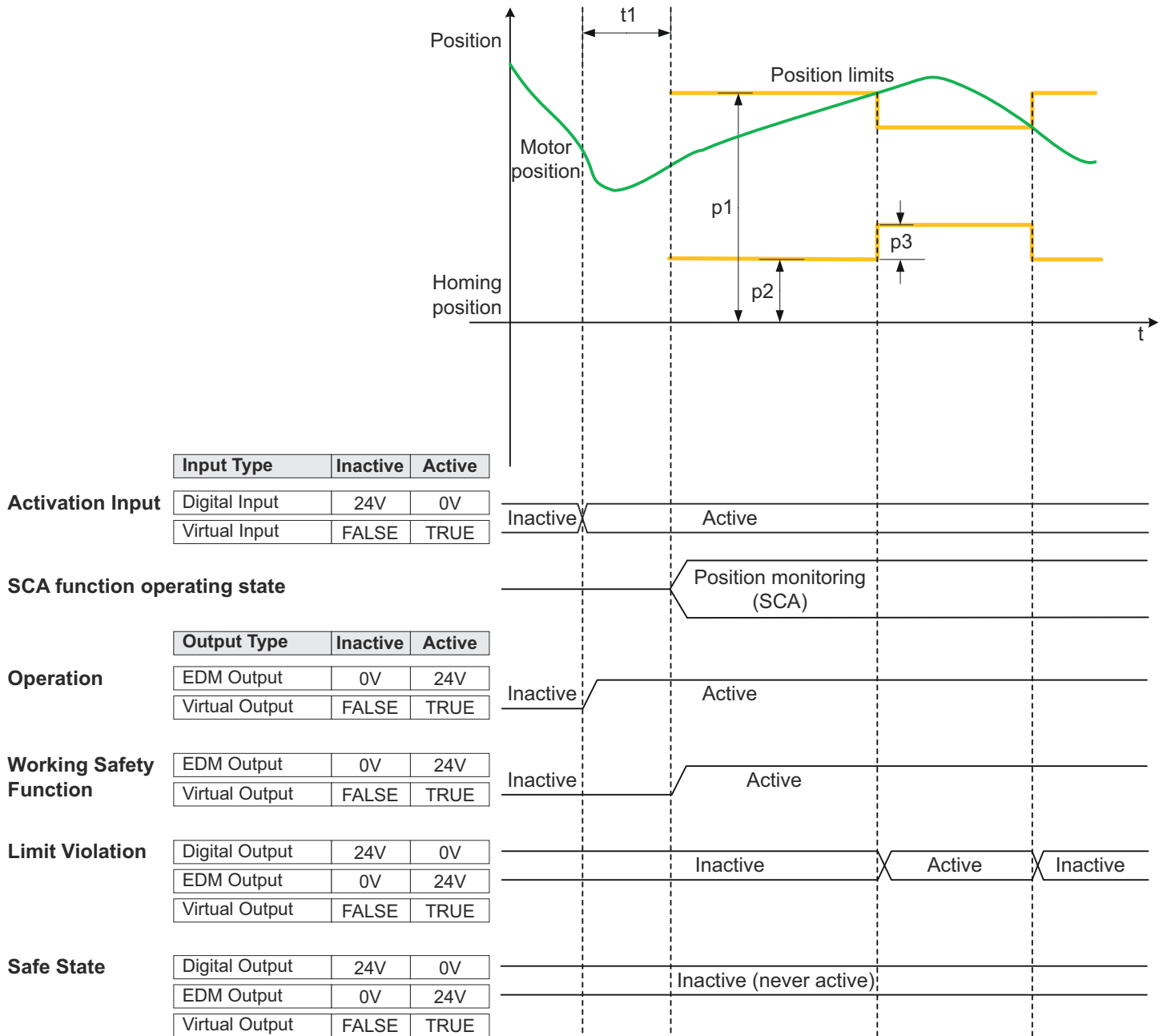

Fig. 67: Safe Cam (SCA)



If the monitored position range relative to the homing position moves into the negative range, this range is shifted and not mirrored.

If the range were mirrored, p1 would no longer be the upper limit value and p2 would no longer be the lower limit value. This would have the consequence that the monitoring of the motor shaft position could no longer be carried out.

In general, the following applies regardless of whether the monitored position range is in the positive or negative range relative to the homing position:

- $p1 > p2$ (upper limit > lower limit)
- $p3 < (p1 - p2) / 2$ (hysteresis < (upper limit - lower limit) / 2)

Parameters

- Waiting Time (t1)
- Distance Limit (p1)

- Distance Limit (p2)
- Distance Limit (p3)

Activation Method

- Low level on the assigned safe input channel
- TRUE signal on the assigned virtual input over FSoE

Return Method

There is no change of the SERVOPACK operating state.

8.18 Safe Speed Monitor (SSM)

Basic Operation

This function provides a safe output signal to indicate whether the motor speed is below a specified limit.



If an EDM output (non-safe) is configured for the output signal type, the configured output signal is also non-safe.

By activation, the safety module starts to monitor the speed and compares it to the limit given in parameter s1. If the speed limit is violated during constant speed monitoring, the safety module will activate the configured output signal. To avoid a flickering of this output signal, a hysteresis (s2) for the speed limit becomes active. The safe output signal will be deactivated if the actual speed decelerates below the limit s1-s2.

The speed limits are bipolar. The speed is monitored independently of the motor run direction.

Safe Speed Monitor (SSM)

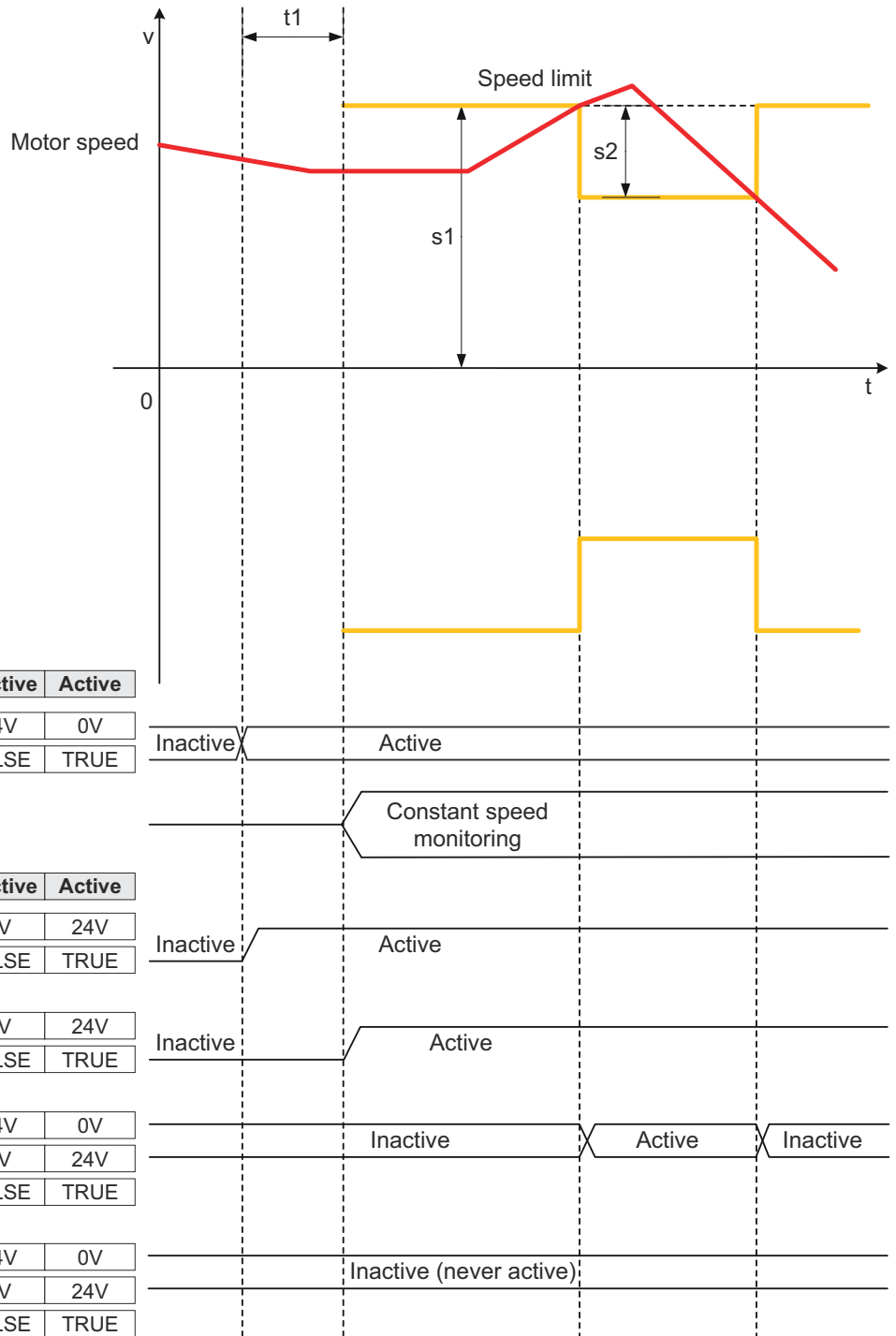

Fig. 68: Safe Speed Monitor (SSM)

Parameters

- Waiting Time (t1)
- Speed Limit 1 (s1)
- Speed Limit 2 (s2)

Activation Method

- Low level on the assigned safe input channel
- TRUE signal on the assigned virtual input over FSoE

Return Method

There is no change of the SERVOPACK operating state.

8.19 Priority of Safety Functions

Safety functions can be configured individually by selecting the activation input and output signal type. Two or more (up to 10: Slots 1 to 10) safety functions will be executed under the following two conditions:

- If one of the safety functions is changed to the safe (HWBB) state, then the other functions will also be changed to the safe (HWBB) state.
- All safety functions operate independently.

Parallel Usage of Two SLS Functions

Both safety functions are running independently. As a result, the valid limit - which is compared to the actual value - is always the more strict one. The figure below shows the parallel usage of two SLS functions. The resulting speed monitoring level is independent of the function operating state (deceleration monitoring, constant speed monitoring) - it will always be the lower speed limit.

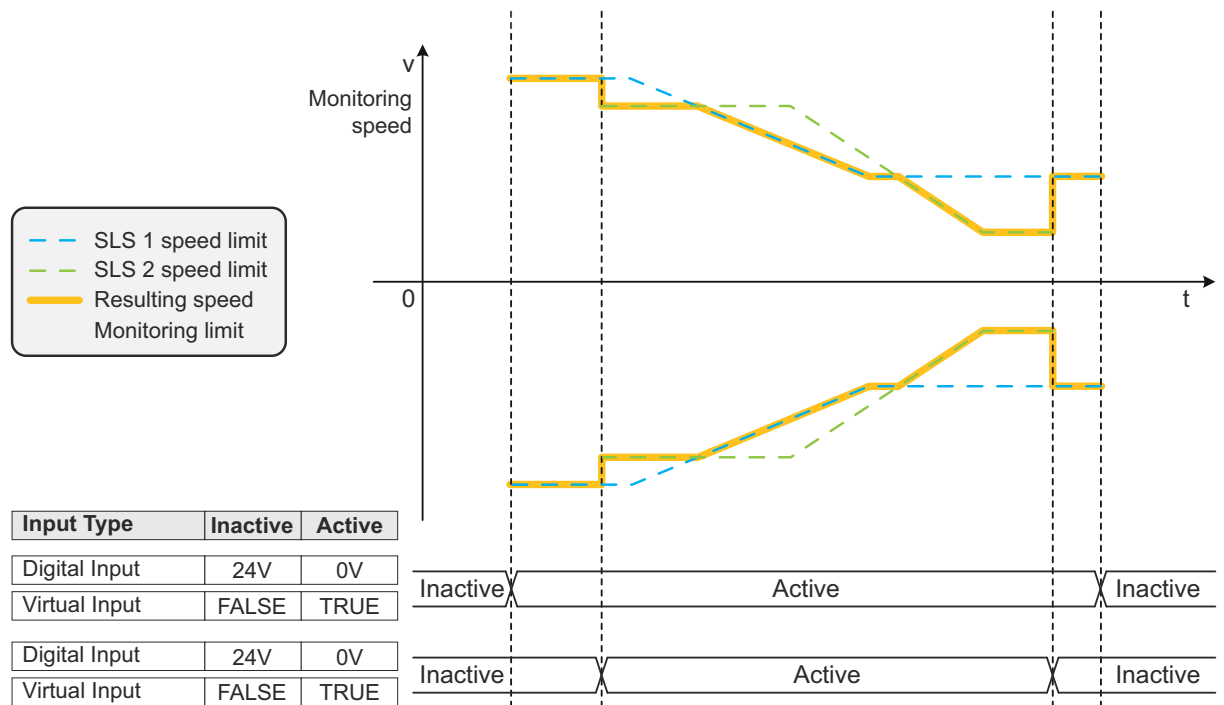

Fig. 69: Parallel Usage of Two SLS Functions

8.20 Output Signal Behavior

8.20.1 General

The user can select between the following output signal behaviors for the safe output, EDM signal and virtual output (FSOE). The selections 1 and 2 are not allowed for Safe Outputs.

Output signal Behavior

Number	PcX00 Configuration I (digit 3)	EDM	Safe Output	Virtual Output
0	None	•	•	•
1	Active during operation The output signal turns active when the corresponding safety function is operating (the signal is a reaction signal against a safety input signal).	•	-	•

Number	PcX00 Configuration I (digit 3)	EDM	Safe Output	Virtual Output
2	<p>Active during working safety function</p> <p>This output signal is a compatible signal to the EDM signal, setting 1, (Safe State Signal) of the SGD7-OSA01A. The output signal turns active while safety function A is in the “OSA01A safe state”. The “OSA01A safe state” depends on the used safety function.</p> <p>SS2, SOS, SDI, SLP, SLI, SCA: When monitoring position or in a safe state (HWBB active)</p> <p>SLS, SSR, SSM: When monitoring speed or in a safe state (HWBB active)</p> <p>STO, SS1: Active during safe state (HWBB active)</p> <p>SLA: When monitoring acceleration or in a safe state (HWBB active)</p> <p>SLT: When monitoring torque or in a safe state (HWBB active)</p> <p>SMT: When monitoring temperature</p>	•	-	•
3	<p>Active after limit violation</p> <p>If this signal behavior is selected, the output signal will remain active after a limit violation. After the Activation Input has been turned inactive and a delay of a defined time, which can be set via a parameter (LVDDT), the output signal “Active after limit violation” is turned inactive again. By turning inactive the signal “Active after limit violation”, the linked safe stop reaction will turn off, too.</p> <p>shows an example, using the safety function SLS and SS2 with two limit violations. shows the same functions but taking back the Activation Input.</p>	•	•	•
4	<p>Active during safe state</p> <p>The output signal will be turned active if the safe state is enabled (HWBB active).</p>	•	•	•



The safe output is **low** active (Active = 0 V) while the EDM output and virtual output signal are **high** active (Active = 24 V, respectively TRUE).

8.20.2 Output Signal Behavior After a Limit Violation

These diagrams provide an example when several safety slots are connected together.

Output Signal Behavior > Output Signal Behavior After a Limit Violation

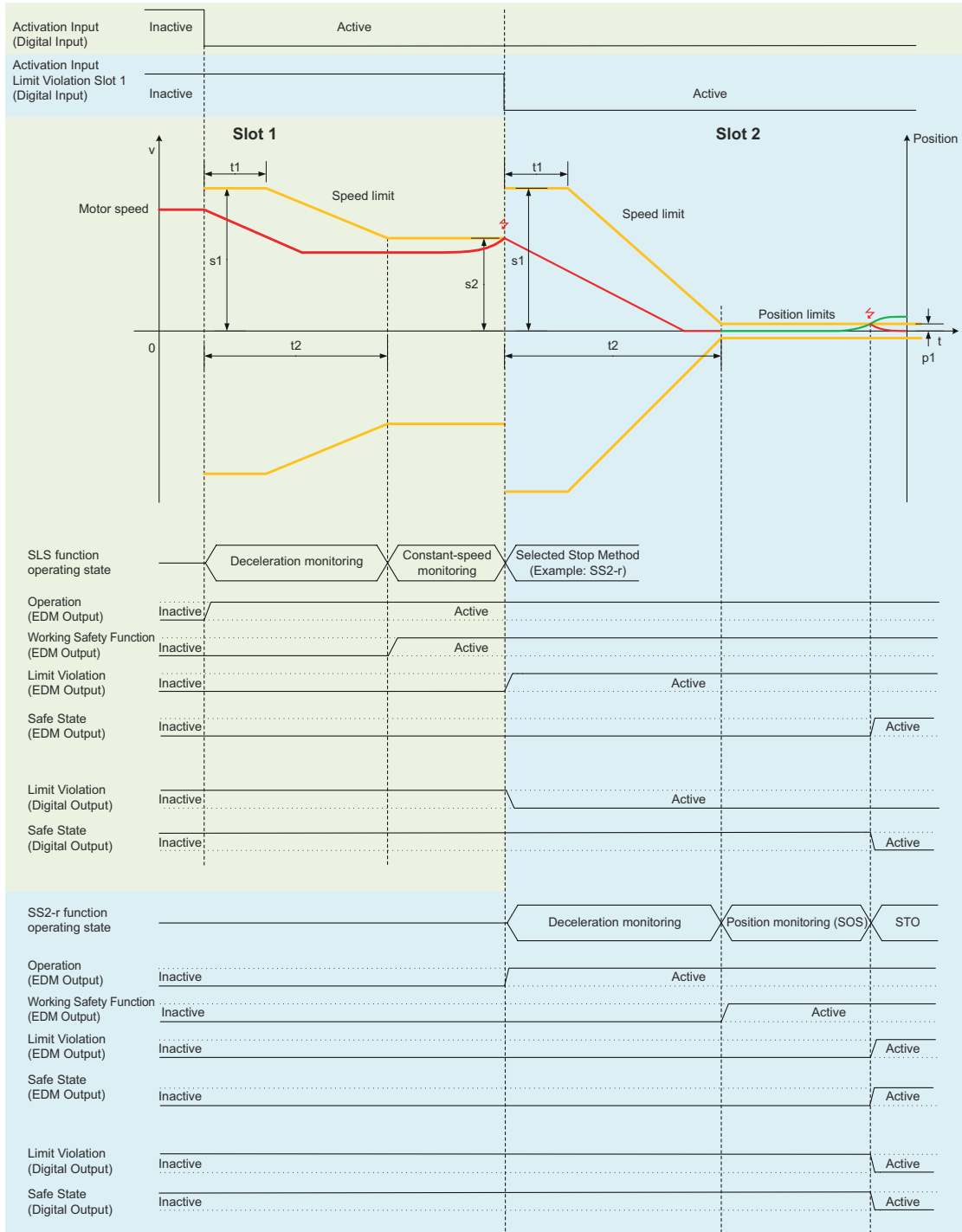

Fig. 70: SLS With SS2 and Final STO

Output Signal Behavior > Limitations for Safety Functions

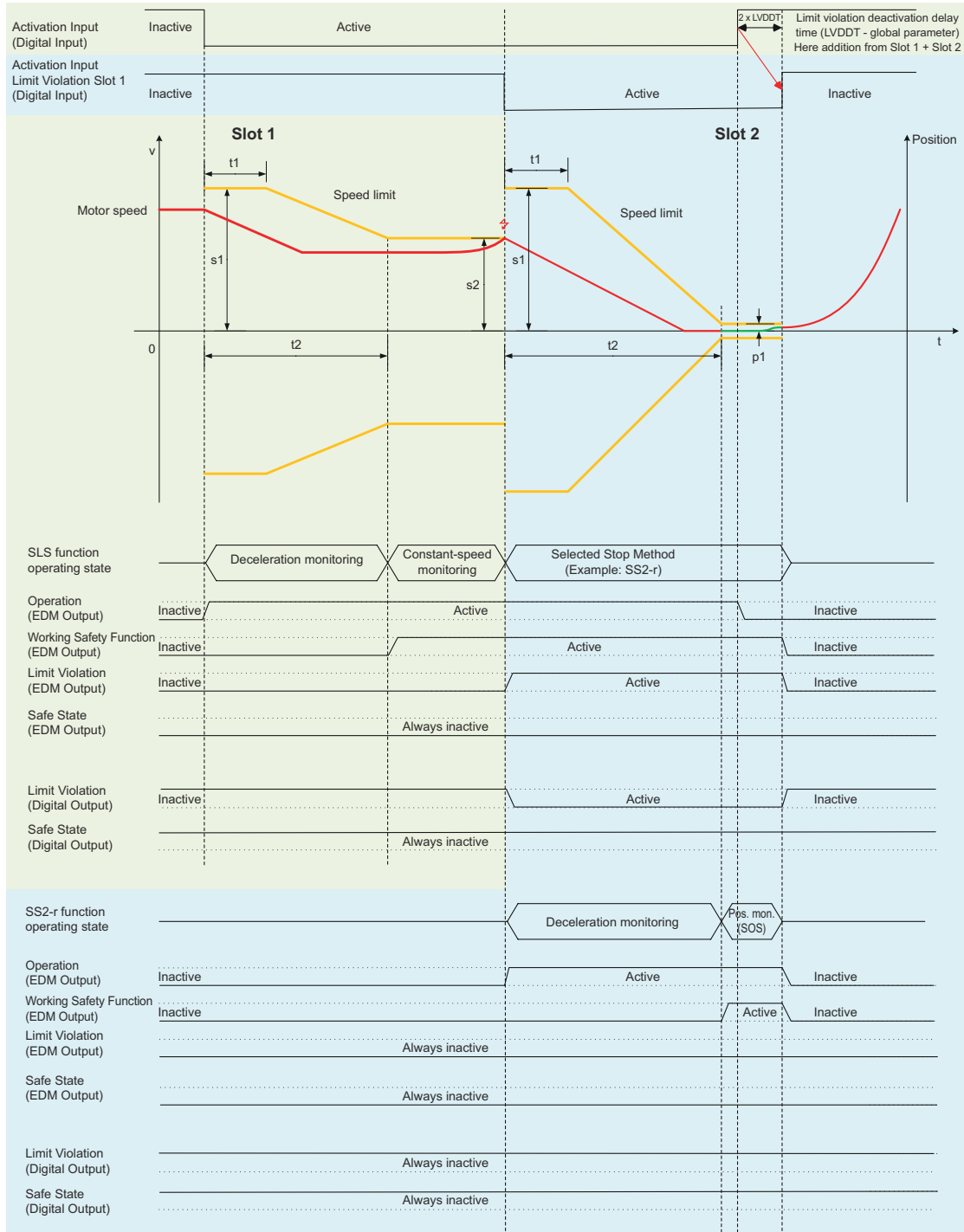

Fig. 71: SLS With SS2 and Activation Input Reset

8.20.3 Limitations for Safety Functions

Safety Function Behavior Before Completing the Polarity Detection Function

If you are using a linear servomotor that does not have a polarity sensor, you must detect the polarity. Polarity detection means that the position of the electrical phase angle on the electrical angle coordinates of the servomotor is detected. The SERVOPACK cannot control the servomotor correctly if it does not know the exact position of the electrical angular coordinates of the servomotor.

If a safety function is activated before polarity detection is completed, the safety module can perform the STO function instead of the original function. This depends on the type of safety function.

Behavior	Safety function
The STO function is operated instead of the original function.	SS1-r, SS2-t, SS2-r, SLS, SLA, SOS, SLP, SLI, SDI, SCA, SHP, SSR
The original functions can be operated.	STO, SS1-t, SLT, SMT
The original functions can be operated, but the EDM signal is never activated.	SSM

For information on how the polarity detection works, refer to the following manual:

Name	Manual number
Σ-7-Series AC Servo Drive Σ-7S SERVOPACK with 400V-Input Power and EtherCAT (CoE) Communications References FT/EX Specification for Advanced Safety Module Product Manual	SIEP S800002 30

9 Setting Parameters

9.1 Overview





This chapter describes the parameters related to the safety functions of the safety module. For the parameters of the SERVOPACK, refer to the manual for your SERVOPACK.

9.2 Advanced Safety Module Parameter Editor

9.2.1 Introduction

With the Advanced Safety Module Parameter Editor (PC configuration tool) the user can configure the safety module offline. The PC configuration tool is used to create a project file (*.asm7) from which a Safe Parameter Container (*.bin) can be generated and includes all parameter settings for the safety module. The user must follow a predefined sequence of configuration when starting a new configuration.

The sequence of configuration is as follows:

1.  General Device Parameters
2.  Motor and Encoder Parameters
3.  User Unit & Encoder Parameters (Optional - required only when user wishes to define his own user units)
4.  I/O Configuration (required only for safety module SGD7S-OSB02A)
5.  Safety Functions (Slot 1 to 10 Parameters)



The order in which the Slot Parameters are configured is irrelevant.



Parameter Groups

- General Device Parameters
- Motor and Encoder Parameters
- User Unit & Encoder Parameters
- I/O Configuration
- Slot 1 Parameters
- Slot 2 Parameters
- Slot 3 Parameters
- Slot 4 Parameters
- Slot 5 Parameters
- Slot 6 Parameters
- Slot 7 Parameters
- Slot 8 Parameters
- Slot 9 Parameters
- Slot 10 Parameters

Check and Commit

Restore Parameter Group

Fig. 72: Parameter Groups as Shown in the Parameter Groups Window Pane of the Advanced Safety Module Parameter Editor



The decimal point is to be used as decimal separator. When entering floating point values, the decimal point must not be entered as a thousands separator.

In order to create a new project file, start the Advanced Safety Module Parameter Editor and select **New Project** in the File menu after which the following dialog will appear. The first step when creating a new project is to select the ASM7 Module Type.

Fig. 73: Create New Project

When selecting the ASM7 Module Type SGD7S-OSB01A (FSoE only), the I/O Configuration is removed from the configuration selection in the Advanced Safety Module Parameter Editor.

9.2.2 General Device Parameters

The following so-called General Device Parameters are entered on the next screen:

- Project Description: Up to 260 characters can be entered here for the purpose of providing a meaningful project description.



According to the IEC 62061 standard, the initial parameterization and subsequent changes to the parameterization must be documented. We recommend that you use the "Project Description" comment field for this purpose. The above standard requires the following points to be documented:

- the date of initial parameterization or modification
- data or version number of the data set
- name of the person who carried out the parameterization
- a reference to the origin of the data used (e.g. predefined parameter sets)
- clear identification of the safety-related parameters
- clear identification of the safety-related control system to which specific parameterization settings apply

- FSoE Address: If the safety module is connected to an FSoE master, then the FSoE address of the safety module can be entered in hexadecimal format here. Otherwise, the FSoE address is set to 0000h (FSoE communication disabled).
- The serial number of the safety module (15 characters required - refer to [Nameplate \(Ratings\) and Model Designation](#)...page 37).

- Limit Violation Deactivation Delay Time (LVDDT) - refer to [↔ 'Limit Violation Deactivation Delay Time \(LVDDT\)'...page 218](#) for a detailed description of this parameter).
- Encoder Filter: This value defines the depth of the Finite Impulse Response (FIR) Filter for the calculation of the internal acceleration value. If the safety function SLA is used, the setting of this parameter is mandatory.

General Device Parameters

Project Description
This is a sample project description

Will the Advanced Safety Module be connected to an FSoE Master?
 Yes
 No

FSoE Address
0x0001

Limit Violation Deactivation Delay Time (LVDDT) (ms)
0

Encoder Filter (samples)
1

Advanced Safety Module Serial Number
123456789ABCDEF

Fig. 74: General Device Parameters

9.2.3 Motor and Encoder Parameters

Motor and encoder parameters are related to the electromechanical components used in the system. After the user has selected the basic application type (rotary, linear) and the motor type (rotary, linear), the user provides more information about the motor (maximum speed, type and use of the motor encoder, motor direction) and the encoder (encoder deviation, encoder deviation window, presence and use of an external encoder). Depending on the application, the user can select the position and velocity units. In addition, the user may be required to provide values for gear ratio(s) and linear feed, e.g. ball screw pitch.

Motor and Encoder Parameters

Basic Application:
 Rotary Application
 Linear Application

Motor Type:
 Rotary Motor
 Linear Motor

Motor Maximum Speed (rpm)
2500

External Encoder:
 None or not used for safety
 Used for safety and fully-closed loop
 Used for safety only

Motor/Encoder Type
SGM7J-***7

Motor Encoder Usage:
 Incremental
 Absolute Single-Turn
 Absolute Multi-Turn

Multi-Turn Limit:
65535

Encoder Type
JZDP-Z001-000

Motor Direction:
 Forward (CCW)
 Reverse (CW)

Encoder Deviation (degree)
0

Encoder Deviation Window (ms)
0

External Encoder Direction:
 Equal to Motor Encoder
 Reverse to Motor Encoder

Position Units
degree

Velocity Units
rpm

Diagram: Sigma-7 Motor -> Gearbox (Input: 1, Output: 1) -> LOAD -> Gearbox (Output: 1, Input: 1) -> Encoder (Ext)

User Units Input Mode:
 Set the user units with graphical assistance
 Enter the user units directly

Fig. 75: Motor and Encoder Parameters

9.2.4 User Units

The user units can be selected in the *Motor and Encoder Parameters Group* (default setting: **User Units Input Mode = Set the user units with graphical assistance**).

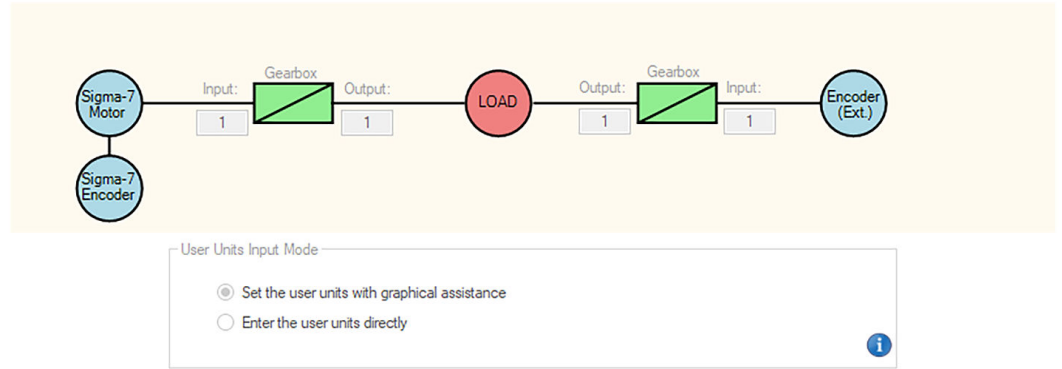

Fig. 76: Setting the User Units With Graphical Assistance

Alternatively, by selecting **Enter the user units directly** for the **User Units Input Mode**, the user can define his own user units.

Motor Encoder User Units			External Encoder User Units	
Numerator Position <input type="text" value="1048576"/>	Position Units <input type="text" value="degree"/>		Numerator Position <input type="text" value="131072"/>	
Denominator Position <input type="text" value="360"/>			Denominator Position <input type="text" value="360"/>	
Numerator Velocity <input type="text" value="1048576"/>	Speed/Velocity Units <input type="text" value="rpm"/>		Numerator Velocity <input type="text" value="131072"/>	
Denominator Velocity <input type="text" value="60"/>			Denominator Velocity <input type="text" value="60"/>	
Numerator Acceleration <input type="text" value="1048576"/>	Acceleration Units <input type="text" value="rpm/s"/>		Numerator Acceleration <input type="text" value="131072"/>	
Denominator Acceleration <input type="text" value="600000"/>			Denominator Acceleration <input type="text" value="600000"/>	
<input type="button" value="Cancel"/>	<input type="button" value="Default"/>		<input type="button" value="Apply"/>	

Fig. 77: Entering the User Units Directly

Application examples for the selection of suitable numerator and denominator values are described in section *Setting Unit Systems* in the corresponding product documentation:

Name	Manual number
Σ-7-Series AC Servo Drive Σ-7S SERVOPACK with 400V-Input Power and EtherCAT (CoE) Communications References FT/EX Specification for Advanced Safety Module Product Manual	SIEP S800002 30



Rotary encoder resolution

If the actual encoder resolution is greater than 20 bits, the resolution is scaled down to 20 bits (1048576 pulses per revolution).

9.2.5 I/O Configuration Parameters

The user can configure up to seven physical I/O ports (available on the module SGD7S-OSB02A only). Depending on the port, different types of digital inputs, digital outputs and analog inputs can be selected and configured.

The screenshot shows the I/O Configuration Parameters editor. It features a grid of configuration options for ports A through G. Port A is configured as a Digital Input with a filter time of 25 ms and a discrepancy time of 50 ms. Ports B, C, D, and E are set to None. Port F is also set to None, but it has a Channel Tolerance (%) field. Port G is configured as an Analog Input.

Fig. 78: I/O Configuration

I/O Port Function Types

Safe	Function Type	A	B	C	D	E	F	G1	G2
2-channel	Digital Input	●	●	●	●	●	●	–	–
2-channel	Digital Input Test Pulse A	–	●	●	●	●	●	–	–
2-channel	Digital Input Test Pulse B	●	–	●	●	●	●	–	–
2-channel	Analog Input (0-10V)	–	–	–	–	–	●	–	–
1-channel	Analog Input (4-20mA)	–	–	–	–	–	–	●	–
1-channel	Analog Input (PT1000)	–	–	–	–	–	–	–	●
2-channel	Digital Output	●	●	●	●	–	–	–	–
no	Digital Output EDM	●	●	●	●	–	–	–	–
2-channel	Digital Output Test Pulse	●	●	–	–	–	–	–	–

● = Available

– = Not available

9.2.6 Safety Functions

The user can configure up to 10 different safety functions (10 slots). These functions can be activated in parallel.

The user can choose the required safety functions out of a list of 16 functions (STO, SS1-r, SLS, SLI, etc.). The user has to configure all parameters associated with the selected safety function (Waiting Time (t1), speed limit s1, monitoring time t2, etc.)

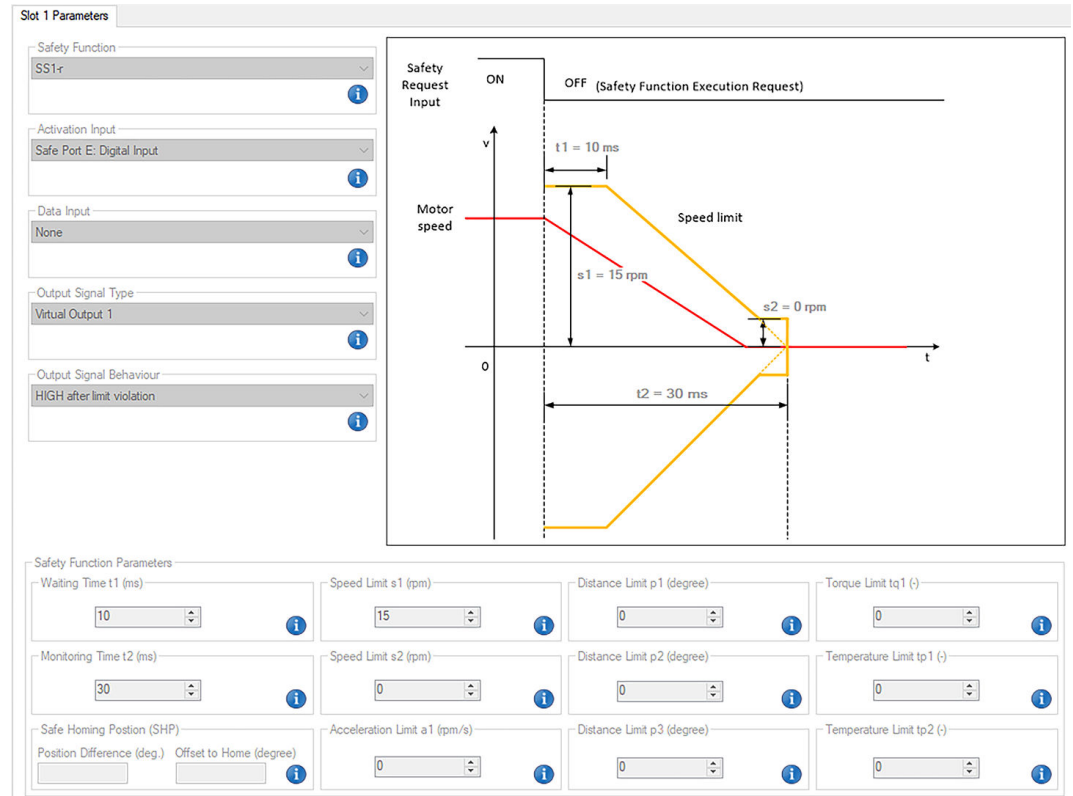

Fig. 79: Safety Function Configuration Example



Do NOT select the function Mapping from the Safety Function pull-down menu - it is not yet implemented, but will be available in a future release.

9.2.7 Double Confirmation

In order to comply with the safety standards, the user must double check and confirm the entries in each parameter group. This is done with the **Check and Commit** button.

9.2.8 Plausibility Checks

The Advanced Safety Module Parameter Editor (PC configuration tool) guides the user while performing the configuration of the safety module. In addition, the PC configuration tool checks the plausibility of the configuration in order to prevent and eliminate technically unfeasible and/or forbidden settings.

A Safe Parameter Container can only be created if all parameters fulfill all restrictions.

9.2.9 Parameter Validation and Safe Container Creation

After completion of the parameter configuration and all parameters have been checked and committed, a validation check (which includes a final plausibility check) can be performed. Upon successful validation, a checksum is generated. When subsequently creating the Safe Parameter Container, this checksum is applied to the safe container in order to "protect" its contents. Prior to creation of a safe container, it is essential that a successful validation check is performed.

To do this, press the *Validate Parameter* button in the *Device* menu or the button shown in the following figure in the toolbar.

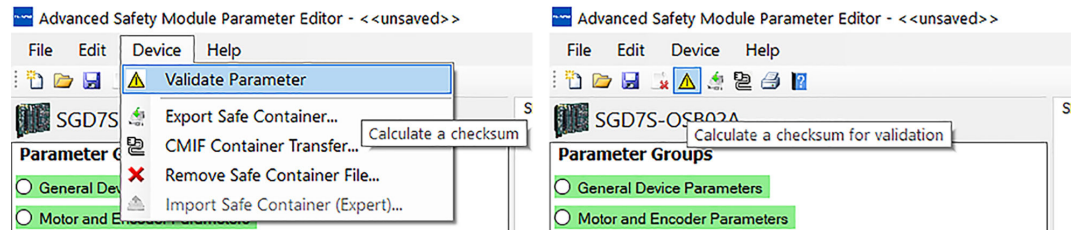

If the validation check was successful, the tool displays the message "CRC calculation successful:" with the resulting CRC32 checksum for the safe parameter container in the message log. If the validation fails, an error message is displayed.

If the parameter validation was successful, a binary safe container file can be generated. This is done by pressing the *Export Safe Container* button.

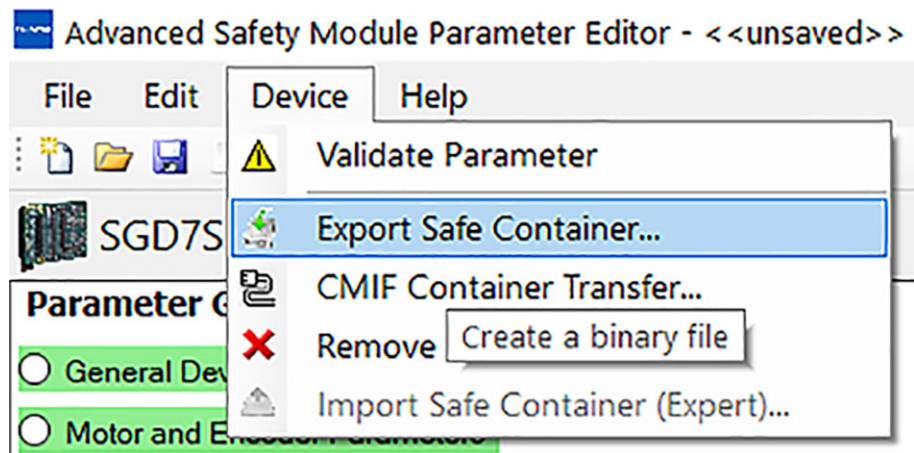

In addition to the checksum mentioned above, the Safe Parameter Container is protected against unauthorized changes by a password.

A password dialog box appears in which you must enter a new password and repeat it to confirm.

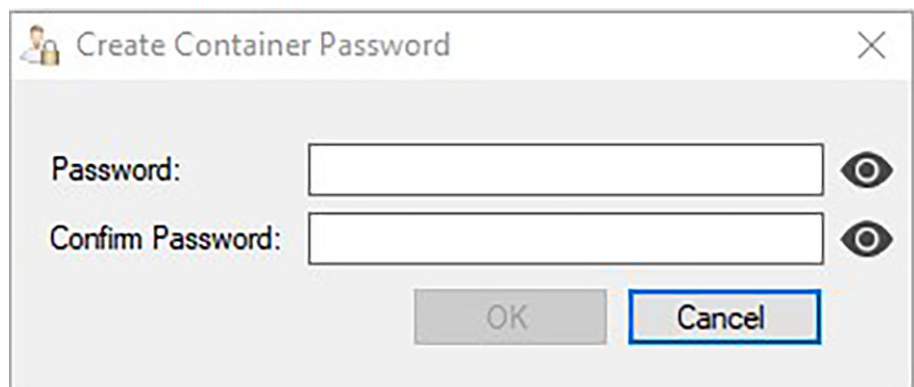

The tool opens a file save dialogue to enter the desired file name in the current output directory. The default extension for the parameter files is ".bin", which indicates binary content.

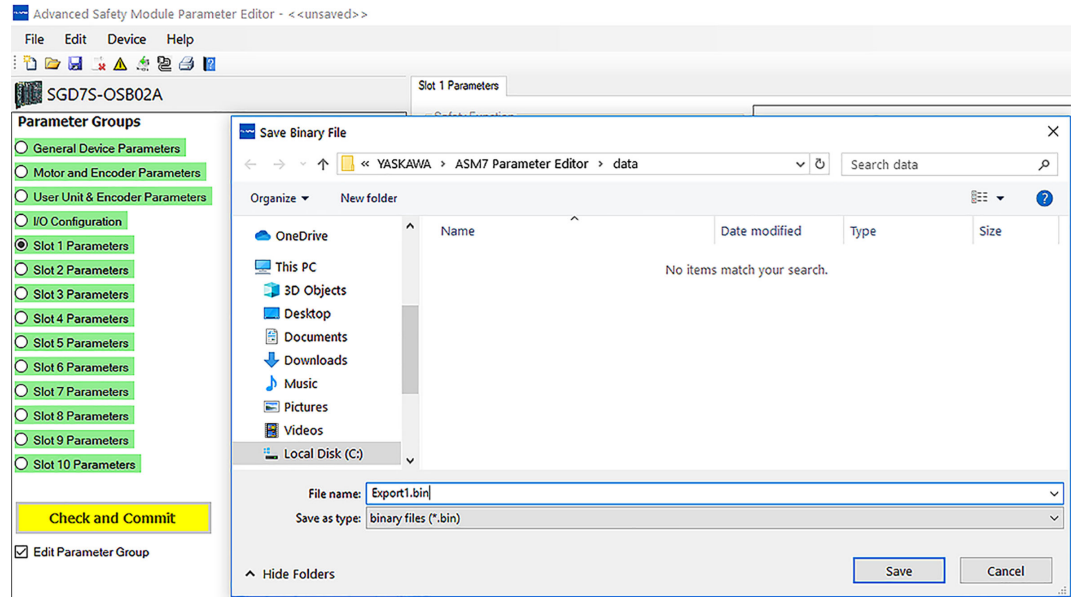

The parameter files are set to read-only after export to prevent accidental deletion. If the same file is to be overwritten, the write protection must be removed. This can be done in the file save dialogue by right-clicking on the existing file and removing the read-only property as shown in the following figure.

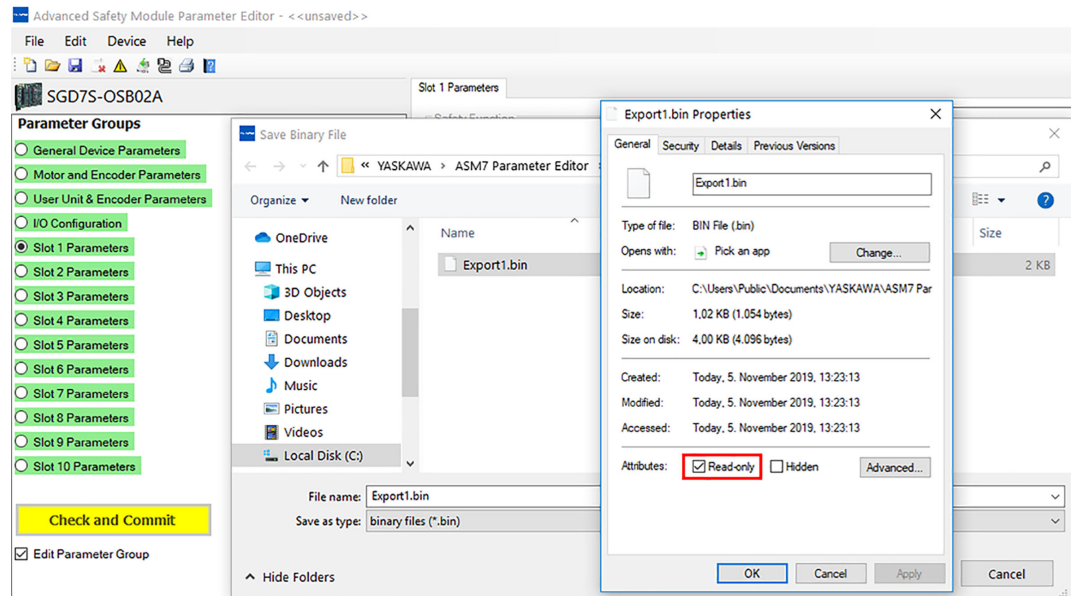

Each time a new parameter container is generated, the tool increments an internal version counter. This counter is also stored in the parameter container and can be used to track changes. This counter is stored in the project file. It is recommended to save the project after each container export, the resulting CRC checksum and the last version counter.

The last step completes the configuration. Save the project before closing the tool.

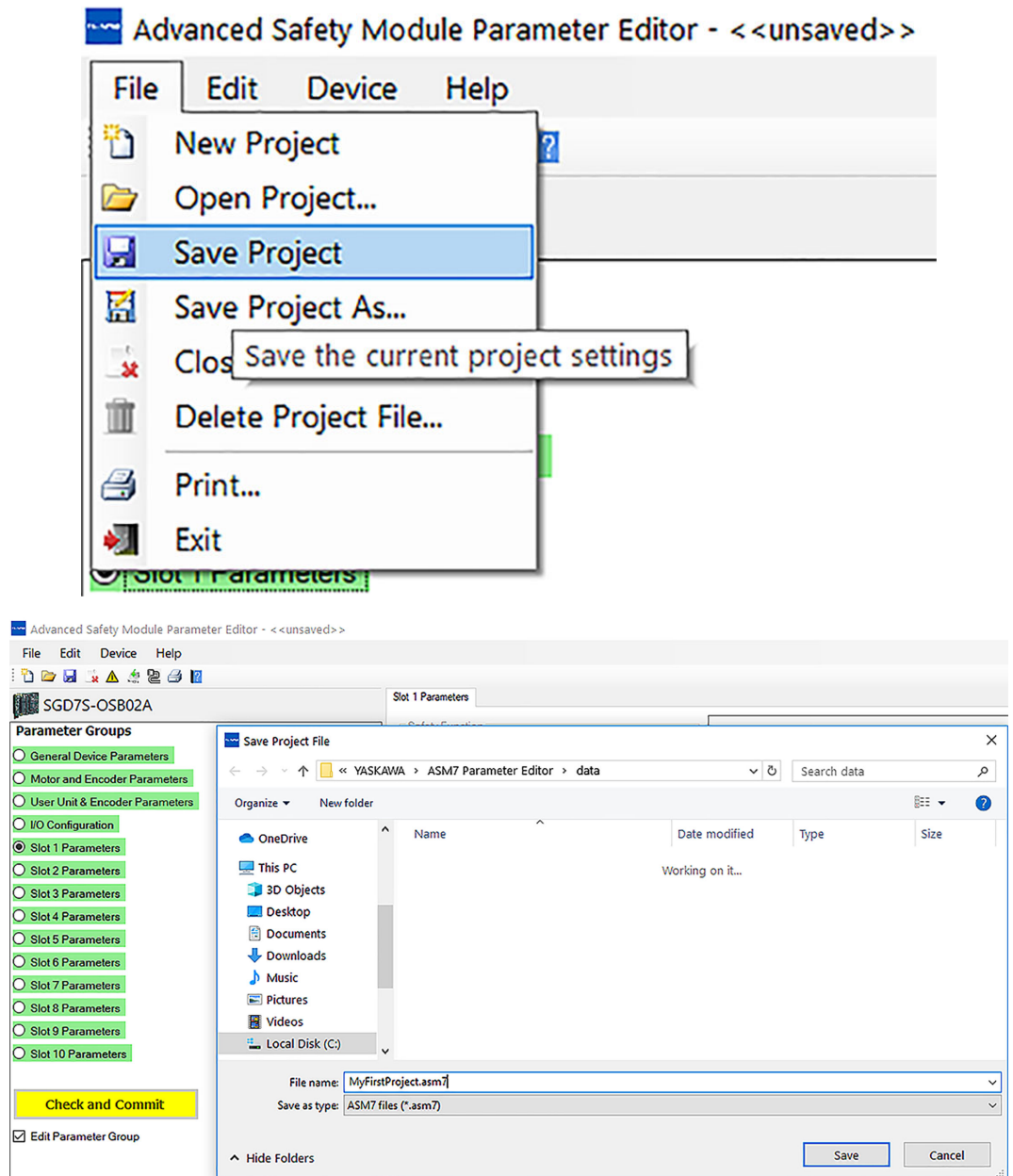

For path and file names, use only printable and permissible characters from the standard ASCII character set. Non-permissible standard ASCII characters are the following; > < : " / \ | ? *



Communication with the SERVOPACK is only possible when one and only one software program uses the designated interface (typically USB). For example, it is not possible to have an online connection to the SERVOPACK using SigmaWin+ and simultaneously use the Safe Container Download function of the Advanced Safety Module Parameter Editor. Otherwise, communication will fail. Either close SigmaWin+ or close the Safe Container Download window of the Advanced Safety Module Parameter Editor.

Downloading a safe container file to the Advanced Safety Module

1. Configure the connection to the SERVOPACK.



At present, the port to which the SERVOPACK is connected can be only the USB port (Port#10 USB). Do NOT select an Ethernet connection!

2. Click on the *Connect* button to connect the SERVOPACK.
 3. When the connection is established, click on the *Load File...* button at the top right of the dialogue.
- ➔

 Safe Container Download
✕

Connection

Used Interface Port: Configure...

Connect

Safe Container File

File Information Box

New Serial Number:

Load File...
Write File...
Update Serial No...

Data Exchange

Received Bytes (hex):

Send File
Receive File
Save Received File...
Read System Info
ASM7 Initialize
Motor and Encoder Parameter Check

Exit

Connected to port 10

4. → Select the desired file in the *Load Safe Container File* dialogue. A message window then opens in which the password for the selected bin file must be entered:

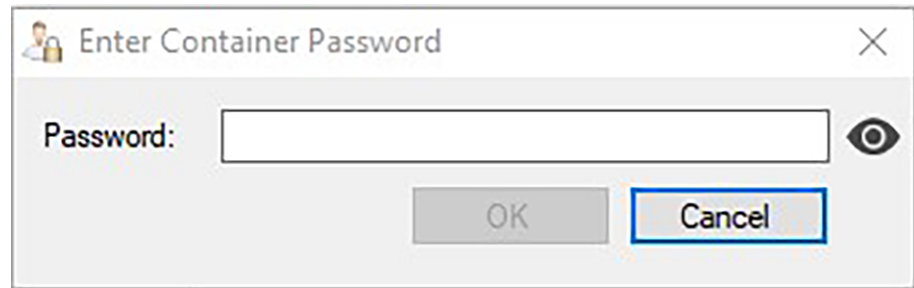

- If the password matches, the bin file will be loaded into the Advanced Safety Module. If the password does not match, the file is not loaded and an error message (message box “Invalid file password. File not loaded.”) is displayed.

The serial number currently associated with the safe container file is displayed in the file information box and in the *New Serial Number* data entry field.

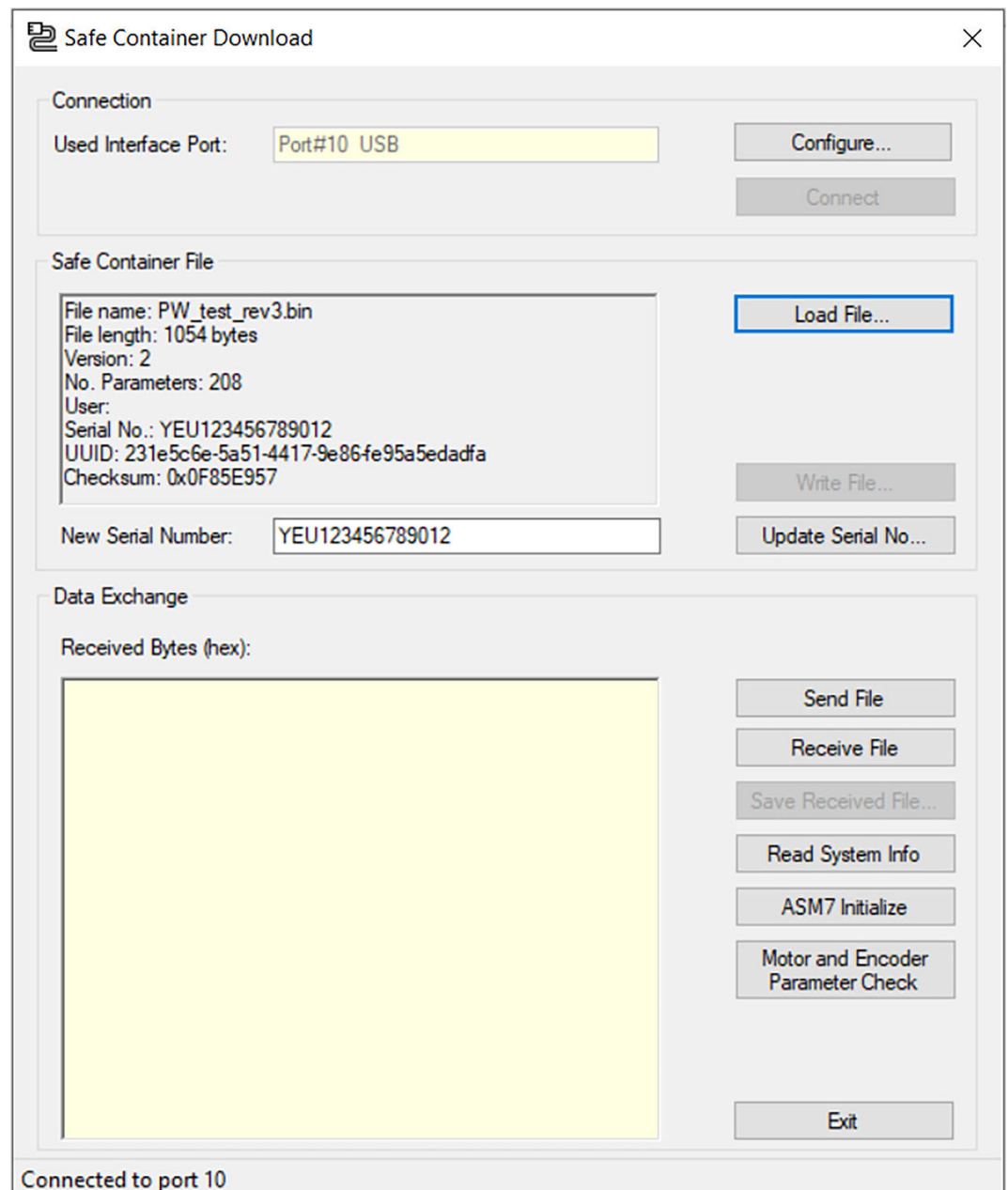

5. → Determine the serial number of the connected Advanced Safety Module. If the serial number of the connected Advanced Safety Module matches the serial number displayed as described in step 4, proceed to step 6.

If the serial number of the connected Advanced Safety Module differs from the serial number displayed as described in step 4, the safe container file must be updated with the serial number of the connected Advanced Safety Module.

Click the *Update Serial No...* button to apply the new serial number to the safe container file.

If the serial number is written to the bin file, this is done without a password prompt, as the password remains unchanged during this process. The CRC of the header of the container file is updated.

The new serial number will be shown in the file information box (and in the *New Serial Number* data entry field) and will be applied to the safe container file for sending. Writing this serial number to the safe container file is not required. If, however, it is desired to make this serial number persistently associated with the safe container file, click the button *Write File*.



Important information for machine manufacturers engaged in serial production

It is possible to assign a serial number without having to save the safe container file again and again for each and every machine axis. Use the one applicable safe container file and update the serial number as required for the whole series. If identical machine axes are to be furnished with the same safe container file, the serial number is entered during the download (see step 5 above) without having to save a new safe container file.

6. → Click on the *Send File* button to start the download.

The tool now checks whether or not a safe container file already exists in the Advanced Safety Module.

If there is no safe container file in the Advanced Safety Module, the safe container file of the parameter tool is downloaded without a password prompt. If a safe container file already exists in the Advanced Safety Module, the user is prompted to enter the password for the safe container file in the Advanced Safety Module:

- ➔ If the password matches, the bin file is downloaded from the tool to the Advanced Safety Module and overwrites the existing file. If the password does not match, the file is not sent and an error message (message field "Invalid file password. Download canceled.") is displayed.

7. → When the download is completed successfully, a *Write Success* message will be displayed.



As a result, the alarm "A.EB9" may occur to indicate a change of the ASM7 parameter set. The user is notified of this alarm via a message box. This change must be activated by a power cycle to enable the new setting (a software reset with SigmaWin+ can also clear the "A.EB9" alarm).

For more detailed information on configuring the safety module using the Advanced Safety Module Parameter Editor, please refer to the corresponding product documentation:

Name	Manual number
Advanced Safety Module for Sigma-7 SERVOPACK SGD7S-□□□DA0□8□□F91, 400 V Application Manual	SIEP YEUOS7S 02

9.2.10 System Validation and Operation

All safety functions as well as the trouble-free functioning of the installed and parameterised system must be tested with the initial operation and after changes. The testing of the system must be documented.



The Advanced Safety Module Parameter Editor's report must be validated (i. e. compared) with the system.

9.3 Types of Parameters

9.3.1 Overview

To operate the safety module, the parameters must be set according to the servo system being used.

There are two types of safety-related parameters:

- Safety-related Module Parameters
- Safety-related Servo Parameters

9.3.2 Safety-Related Module Parameters

9.3.2.1 Overview

The safety-related module parameters are used to set the safety functions and are only used for the safety module. The safety-related module parameters are listed in the tables:

- [↪ 'General Device Parameters'...page 218](#)
- [↪ 'User Unit and Encoder Parameters'...page 231](#)
- [↪ 'I/O Configuration Parameters'...page 237](#)
- [↪ 'Slot Parameters'...page 241](#)

9.3.2.2 Operation Procedures

The procedures for editing and initialising the safety-related module parameters are given in [↪ 'Advanced Safety Module Parameter Editor'...page 124](#).

9.3.3 Safety-Related Servo Parameters

9.3.3.1 Overview

The safety-related servo parameters contain information about the motor and encoder configuration of the SERVOPACK and are managed by the safety module. This information is held in the SERVOPACK, but it is also managed in the safety module with different parameter numbers. The safety-related servo parameters are listed in the table:

- [↪ 'Motor and Encoder Parameters'...page 219](#)



When the unit consisting of SERVOPACK and safety module is switched on, the values of this parameter group stored in the SERVOPACK are compared with the values of the corresponding parameters in the safety module. If the values do not match, alarm A.EC1 (Safety-related Servo Parameter Unmatch Alarm) is displayed.

The safety-related servo parameters that do not match between SERVOPACK and safety module can be displayed with utility function Fn042 → [‘Utility Functions for Setup’...page 156](#) or by pressing the button A.EC1 confirmation in the PC configuration tool → [‘Advanced Safety Module Parameter Editor’...page 124](#).

9.3.3.2 Operation Procedures

The procedures for editing and updating the safety-related servo parameters are given in → [‘Advanced Safety Module Parameter Editor’...page 124](#).

10 Set-Up and Replacement of the Safety Module

10.1 Overview

This chapter describes the initialisation of the safety module. In addition to the initial commissioning of a new safety module with a new SERVOPACK, the changeover to a different type of safety module as well as the procedure for replacing a defective safety module or a defective SERVOPACK are also described.

10.2 Initial Set-Up of a New Safety Module With a New SERVOPACK

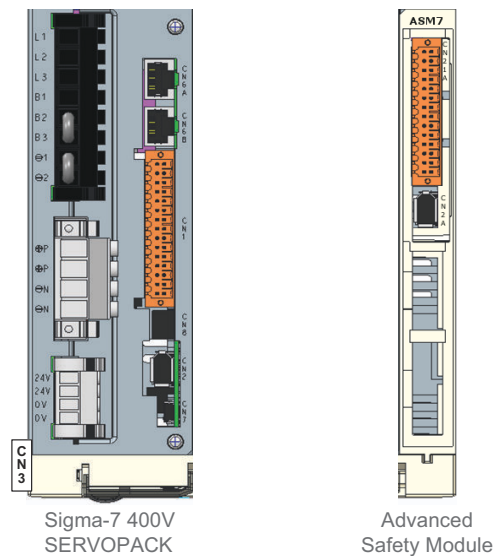

Fig. 80: SERVOPACK and Safety Module (Not Connected)

1. → Attach a safety module with factory settings to a new SERVOPACK.



We use the term "new" safety module in the following cases:

- If the safety module is a brand-new product from the factory
- After command Fn043 ("Safety Option Module Initializing Parameter Setting") was executed. Further information on Fn043 can be found in → 'Initialisation of a Safety Module Already in Operation With a New SERVOPACK'...page 147.

The state "new" safety module means:

- No SERVOPACK serial number stored
- No safe container stored
- No homing information stored

2. Power on the SERVOPACK.



After the voltage has been switched on, the pairing of the safety module and the SERVOPACK is carried out automatically.

After

- the pairing of the safety module,
- homing,
- safe container download,
- alarm

write accesses to the non-volatile memory take place, therefore you should wait a while after these events before switching off the supply voltage.

- ■ The SERVOPACK stores that the safety module is connected.
- The safety module stores the serial number of the connected SERVOPACK.



If the serial number of the SERVOPACK could not be transferred/stored successfully, the alarm „Safety Module: Confirmation Alarm“ (A.EC0) is set/displayed. In this case, continue with sequence described in ➔ [‘Initialisation of a Safety Module Already in Operation With a New SERVOPACK’...page 147.](#)

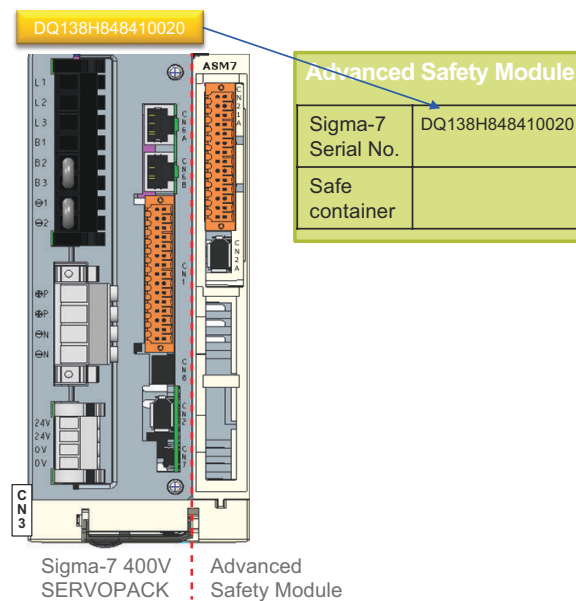

Fig. 81: Pairing of Safety Module and SERVOPACK

3. The Safety-related Servo Parameter Unmatch Alarm (A.EC1) is displayed.
Alarm cause: There is no valid safe container in the safety module.
4. Continue with sequence described in ➔ [‘Parameterisation With the Advanced Safety Module Parameter Editor’...page 141](#)

10.3 Parameterisation With the Advanced Safety Module Parameter Editor

1. Connect the PC to the SERVOPACK and start the Advanced Safety Module Parameter Editor (PC configuration tool).



The safe parameters are configured offline with the Advanced Safety Module Parameter Editor (PC configuration tool).

Every set of safe parameters must be assigned to a safety module serial number.

2. Create a new project configuration file. After all required parameters have been configured, checked and committed, perform a parameter validation. If the parameter validation is successful, create a Safe Parameter Container (→ 'Advanced Safety Module Parameter Editor'...page 124).



The configured parameter set is packed to a safe container by the Advanced Safety Module Parameter Editor and equipped with a checksum. All non-safe SERVOPACK parameters can be modified with SigmaWin+.

3. Send the safe container with the correct serial number of the safety module to the safety module using the PC configuration tool (Advanced Safety Module Parameter Editor).

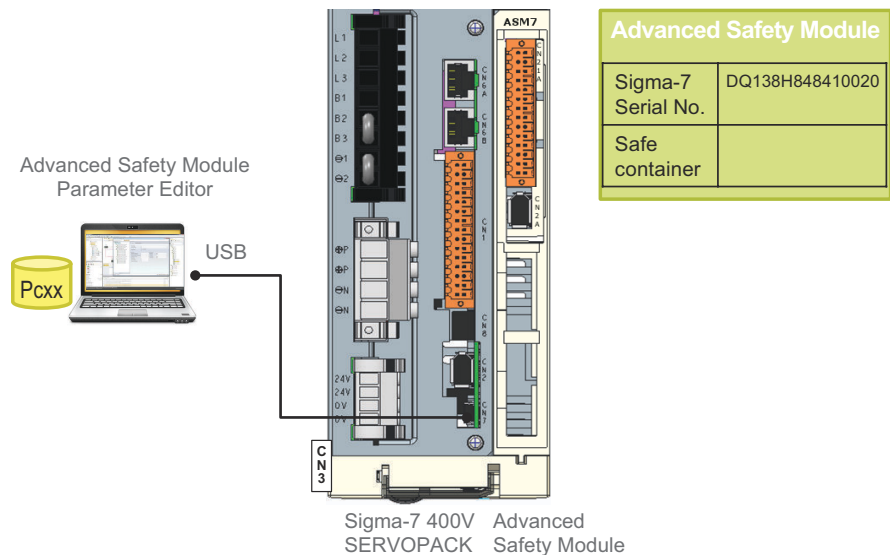

Fig. 82: Sending the Safe Parameter Container

4. The "Safety Module: Parameter Change Alarm" (A.EB9) is displayed.
Alarm cause: A safety-related module parameter was changed.



A.EB9 is only displayed if no other alarm is active (e.g. A.EC1). If another alarm (e.g. A.EC1) is active, A.EB9 is only visible in the alarm history.

5. Power off the SERVOPACK.
6. Power on the SERVOPACK.
→ The SERVOPACK/Safety module combination is ready for operation.

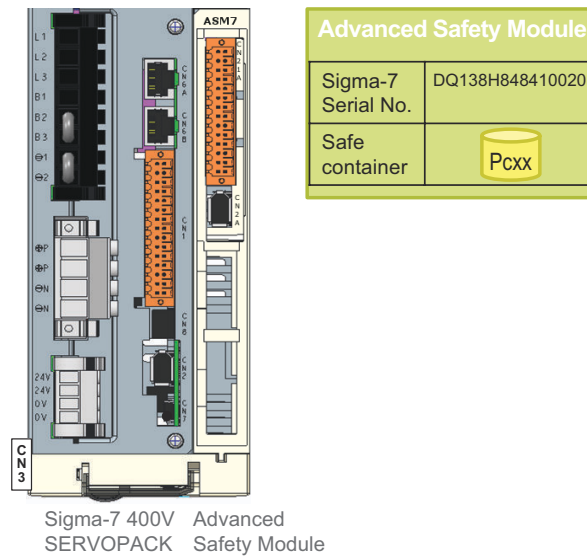

Fig. 83: Safety Module and SERVOPACK Ready for Operation

7. → Depending on the safety function(s) used, perform the homing procedure if necessary (→ 'Safe Home Position (SHP)'...page 151).

10.4 Replacement Procedure

10.4.1 Initialisation of a New Safety Module With a SERVOPACK Already in Operation

10.4.1.1 Initialisation of a New Safety Module (Identical Type) With a SERVOPACK Already in Operation

1. → Attach the new safety module (of the same type as the one used previously) to the (old) SERVOPACK.



We use the term "new" safety module in the following cases:

- If the safety module is a brand-new product from the factory
- After command Fn043 ("Safety Option Module Initializing Parameter Setting") was executed. Further information on Fn043 can be found in → 'Initialisation of a Safety Module Already in Operation With a New SERVOPACK'...page 147.

The state "new" safety module means:

- No SERVOPACK serial number stored
- No safe container stored
- No homing information stored

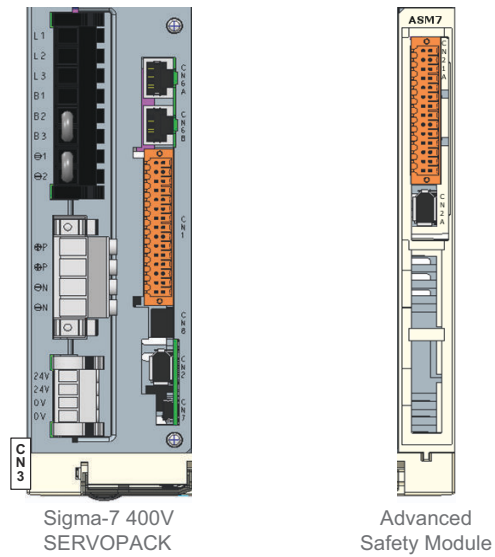

Fig. 84: SERVOPACK and Safety Module (Not Connected)

2. Power on the SERVOPACK.

➔ The safety module stores the serial number of the connected SERVOPACK.



If the serial number of the SERVOPACK could not be transferred/stored successfully, the alarm „Safety Module: Confirmation Alarm“ (A.EC0) is set/displayed. In this case, continue with sequence described in ➔ ‘Initialisation of a Safety Module Already in Operation With a New SERVOPACK’...page 147.

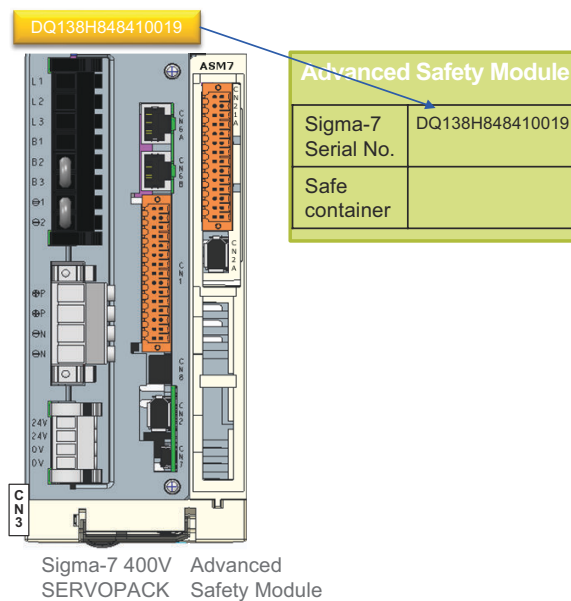

Fig. 85: Pairing of Safety Module and SERVOPACK

3. The Safety-related Servo Parameter Unmatch Alarm (A.EC1) is displayed.

Alarm cause: There is no valid safe container in the safety module.

4. → Continue with sequence described in → [‘Parameterisation With the Advanced Safety Module Parameter Editor’...page 141](#)

10.4.1.2 Initialisation of a New Safety Module (Different Type) With a SERVOPACK Already in Operation

1. → Attach the new safety module (of a different type than the one previously used, i. e. change from SGD7S-OSB01A to SGD7S-OSB02A or vice versa) to the (old) SERVOPACK.



We use the term "new" safety module in the following cases:

- If the safety module is a brand-new product from the factory
- After command Fn043 ("Safety Option Module Initializing Parameter Setting") was executed. Further information on Fn043 can be found in → [‘Initialisation of a Safety Module Already in Operation With a New SERVOPACK’...page 147.](#)

The state "new" safety module means:

- No SERVOPACK serial number stored
- No safe container stored
- No homing information stored

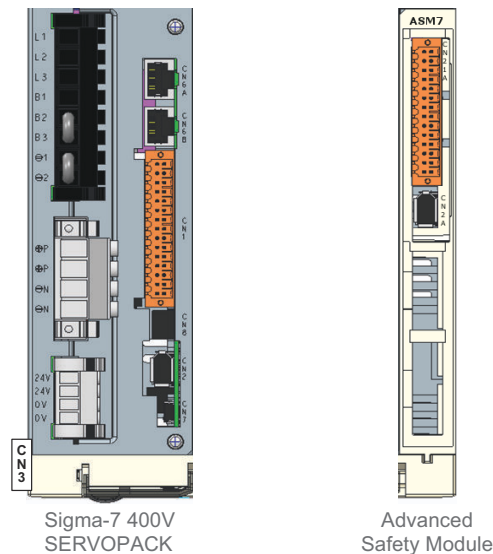

Fig. 86: SERVOPACK and Safety Module (Not Connected)

2. → Power on the SERVOPACK.
- ➔ The safety module stores the serial number of the connected SERVOPACK.



If the serial number of the SERVOPACK could not be transferred/stored successfully, the alarm „Safety Module: Confirmation Alarm“ (A.EC0) is set/displayed. In this case, continue with sequence described in → [‘Initialisation of a Safety Module Already in Operation With a New SERVOPACK’...page 147.](#)

3. → The "Safety Module Unmatch" alarm (A.E81) is displayed.
- Alarm cause: A safety module of a different type was connected.

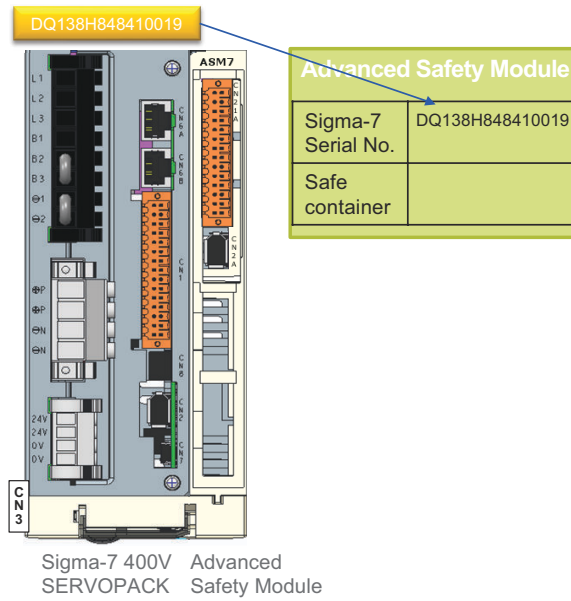

Fig. 87: Pairing of Safety Module and SERVOPACK

4. Execute Fn014 (Reset Option Module Configuration Error) with SigmaWin+ or the Digital operator.

With the help of this step, the SERVOPACK deletes that a safety module was connected.

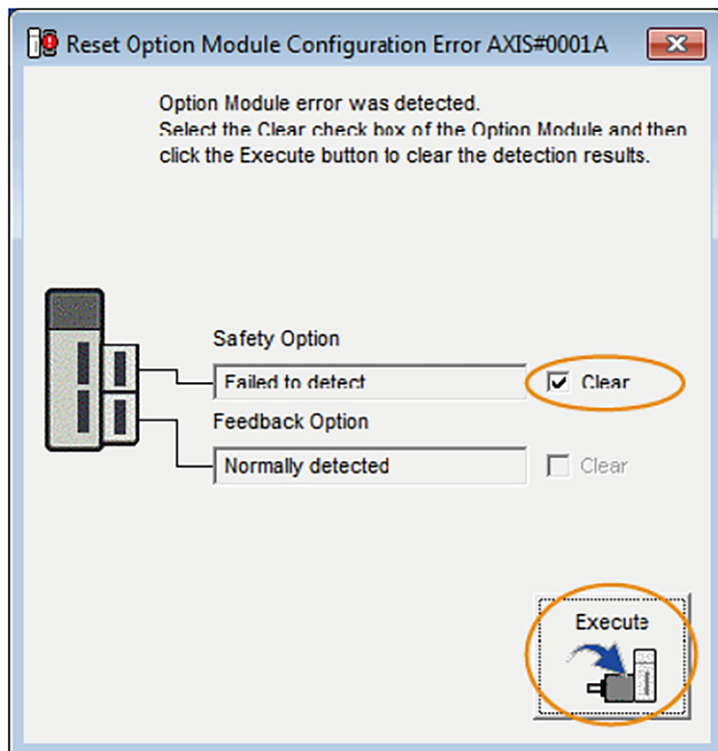

Fig. 88: Reset Option Module Configuration Error

i Please note that the USB port can only be used by one tool at a time. In this case, you should first close the Advanced Safety Module Parameter Editor before opening SigmaWin+.

5. Power off the SERVOPACK.
6. Power on the SERVOPACK.
 - ➔ The SERVOPACK stores that the safety module is connected.
7. The Safety-related Servo Parameter Unmatch Alarm (A.EC1) is displayed.
Alarm cause: There is no valid safe container in the safety module.
8. Continue with sequence described in ➔ [‘Parameterisation With the Advanced Safety Module Parameter Editor’...page 141](#)

10.4.2 Initialisation of a Safety Module Already in Operation With a New SERVOPACK

1. Attach the (old, i. e. already configured) safety module to the (new) SERVOPACK.



We use the term "old" safety module when the module has already been connected to a SERVOPACK.

The state "old" safety module means:

- SERVOPACK serial number stored
- Optional: Safe container stored
- Optional: Homing information stored

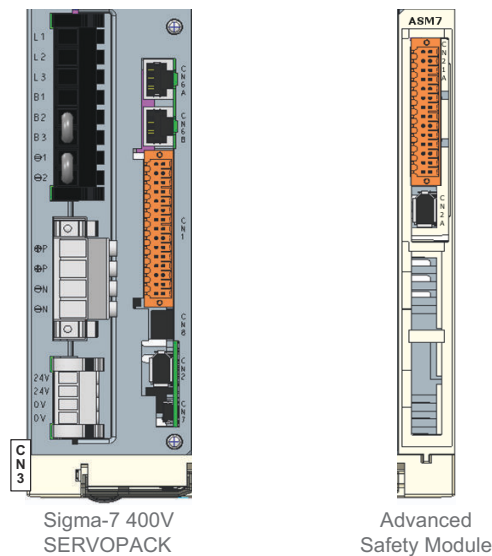

Fig. 89: SERVOPACK and Safety Module (Not Connected)

2. Power on the SERVOPACK.
 - ➔ The SERVOPACK stores that the safety module is connected.

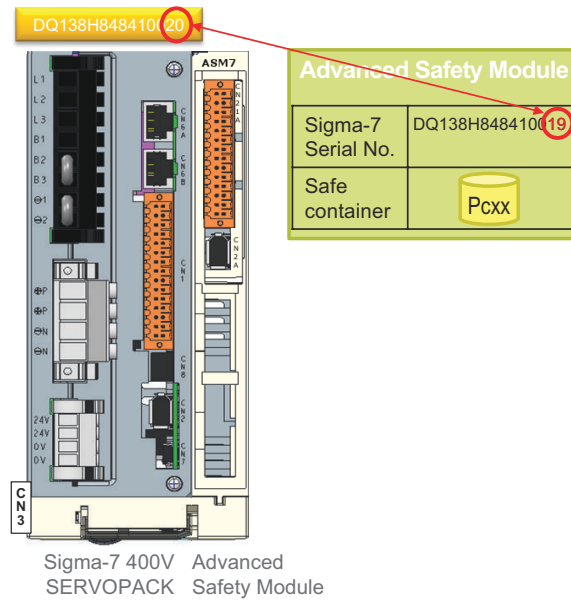

Fig. 90: Initialisation of Safety Module With a Different SERVOPACK

3. The Safety Module Confirmation Alarm (A.EC0) is displayed.
Alarm cause: Serial number of the SERVOPACK and serial number of the SERVOPACK stored in the safety module do not match.
4. With the Advanced Safety Module Parameter Editor: Click on button "ASM7 Initialize".
 - ➔ This function deletes the serial number of the SERVOPACK, the homing information and the safe container in the non-volatile memory of the safety module.



The serial number specified in the New Serial Number field must be the serial number of the currently connected Advanced Safety Module.

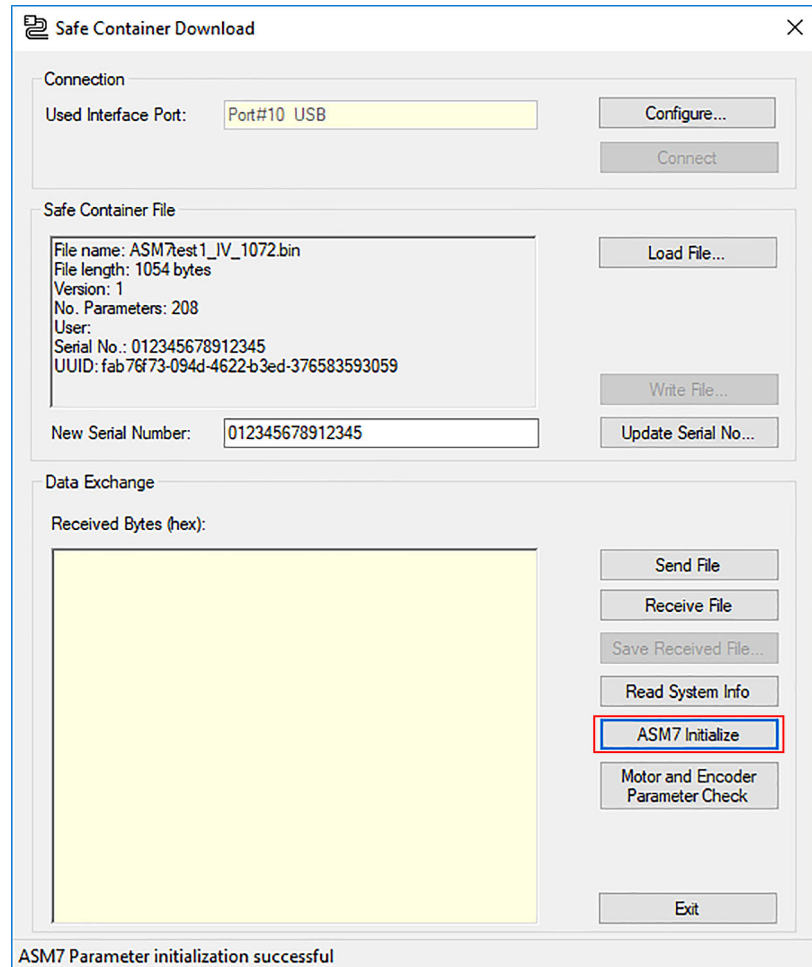

Fig. 91: ASM7 Initialize Button

5. Alternative possibility with the Digital Operator (replaces step 4): Execute Fn040 (Safety Option Module Access Mode Setting).
To activate this function, the last four characters of the serial number of the safety module (attached to the SERVOPACK) must be entered (range = 0001 to 9999).
➔ This function enables the execution of Fn043.
6. Execute Fn043 (Safety Option Module Initializing Parameter Setting) with the Digital Operator.
➔ This function deletes the serial number of the SERVOPACK, the homing information and the safe container in the non-volatile memory of the safety module.
7. Power off the SERVOPACK.
8. Power on the SERVOPACK.
➔ The safety module stores the serial number of the connected SERVOPACK.



If the serial number of the SERVOPACK could not be transferred/stored successfully, the alarm „Safety Module: Confirmation Alarm“ (A.EC0) is set/displayed. In this case, continue with sequence described in ➔ ‘Initialisation of a Safety Module Already in Operation With a New SERVOPACK’...page 147.

9. The Safety-related Servo Parameter Unmatch Alarm (A.EC1) is displayed.
Alarm cause: There is no valid safe container in the safety module.
10. Continue with sequence described in ➔ ‘Parameterisation With the Advanced Safety Module Parameter Editor’...page 141

10.4.3 End of Use of the Safety Module

1. ➤ Disconnect the safety module from the SERVOPACK.
2. ➤ Clear Safety Option Detection Failure (A.E71).

10.5 Safety Module Detection Function

10.5.1 Connected State Detection Function

The Connected State Detecting Function detects the safety module connected to the SERVOPACK and decides whether the correspondence is right or wrong.

An alarm is triggered depending on the following conditions and situations:

- If the safety module was connected to the SERVOPACK and then removed, the SERVOPACK will activate the alarm (A.E71) *Safety Option Module Detection Failure* after it has been restarted.
- If the safety module is different from the last safety module which was connected to the SERVOPACK, the SERVOPACK will activate the alarm (A.E81) *Safety Module Unmatch* after it has been restarted.
- When the safety module is not supported by the SERVOPACK, then the SERVOPACK will activate the alarm (A.E74) *Safety Module Non-support*.

10.5.2 Solid Detection Function

The Solid Detection Function detects whether the combination of safety module and SERVOPACK was changed.

The Safety Module Confirmation Alarm (A.EC0) is issued when one of the following conditions applies:

- the serial number of the SERVOPACK could not be transferred/stored successfully in the safety module,
- the combination of safety module and SERVOPACK is changed, i. e. the serial number of the SERVOPACK and the serial number of the SERVOPACK stored in the safety module do not match.

This alarm is active when the safety module being mounted is different from the last safety module which was connected to the SERVOPACK or when the safety module could not store the serial number of the connected SERVOPACK.

10.6 Safe Home Position (SHP)

Basic Operation

The Safe Home Position (SHP) function can be configured in one of the Safety Slots 1 to 10. It is used to validate the actual encoder position as safe position (usually the previously established origin of the machine). Virtual or physical safe digital inputs can be used as activation signal and to trigger the position latch.

The Safe Home Position (SHP) function is mandatory for the use of the following safety functions:

- SLP (Safely Limited Position): Safe Motion Function
- SCA (Safe Cam): Safe Monitoring Function

To execute these functions, the safety module must know the reference position. The homing procedure is performed using the Safe Home Position (SHP) function.

The safety functions SLP and SCA

- may only be executed with a valid Safe Home Position (SHP Status = TRUE).
- may only be used for limited (linear) applications.

The figure below shows an example with a physical switch for the trigger signal, the activation signal to enable the Safe Home Position (SHP) is not included.

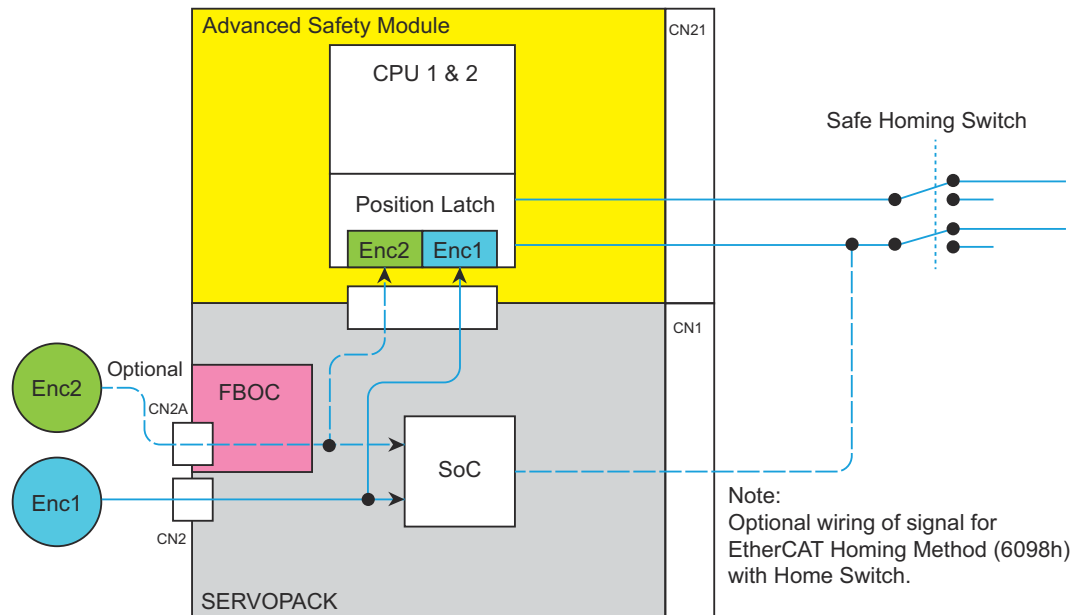

Fig. 92: Safe Homing Position Concept

The user must use the Safe Homing Switch (Data Input) to latch the Home Position.

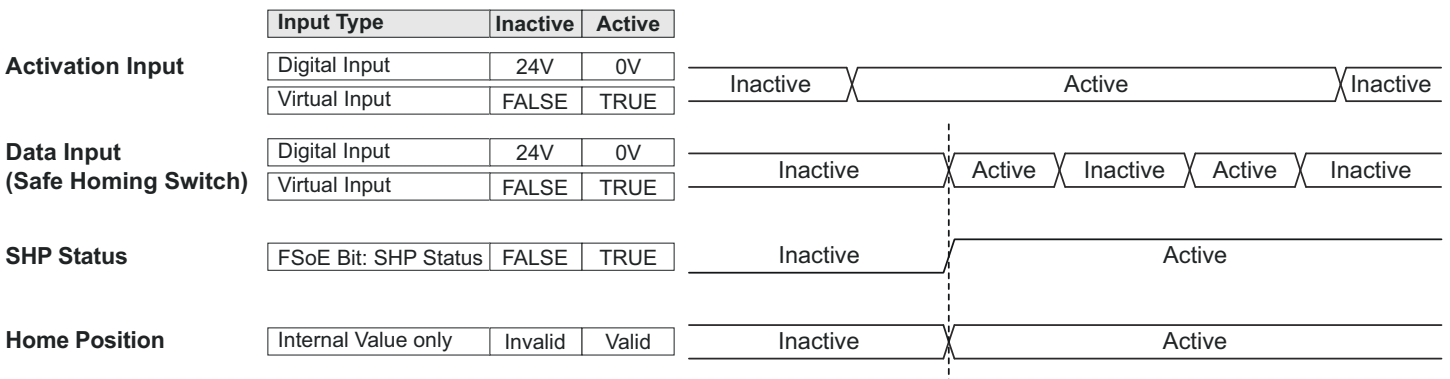

Fig. 93: Safe Homing - Input Signal Timing

Safe Home Position (SHP)

After Safe Home Position (SHP) function was activated and the Waiting Time (t1) elapsed, the first active edge of the Safe Homing Switch (Data Input) will latch the Home Position. Each further active edge has no influence on the Home Position.



If it should be necessary to deactivate a valid and stored Home Position, this can only be done by one of the following actions:

- Download the safe container again
- Fn043 (using the Digital Operator) → 'Utility Functions for Setup'...page 156
- ASM7 Initialize Button (using the Advanced Safety Module Parameter Editor) → 'Initialisation of a Safety Module Already in Operation With a New SERVOPACK'...page 147.

Parameters

- Waiting Time (t1)
- Offset to Home
- Position Difference

Waiting Time (t1)

Waiting Time (t1) is the delay time until the trigger for the position latch is evaluated. The minimum value for Waiting Time (t1) is 50 ms. A detected edge on Data Input after Waiting Time (t1) elapsed will execute the SHP function.

Offset To Home

The user must determine the position offset between the machine origin (Zero Position) and the Home Position. This value has to be entered to parameter *Encoder Offset E1 to Homing Position (Origin)* (Pc09C).

Pc09C is always specified in user units. In the *Advanced Safety Module Parameter Editor* the input field of this parameter is named *Offset to Home*.



Home Position = Zero Position + Offset to Home

Position Difference

Position Difference, i.e. parameter *Encoder Absolute Position Difference E1 to E2* (Pc09A) is only relevant for two encoder configurations (SIL 3) and needs to be set for the following configuration:

- Rotary Application
- Rotary Motor
- Motor Gear Ratio 1:1
- External Encoder Gear Ratio 1:1
- Motor Encoder Type: "Absolute Multiturn" or "Absolute Singleturn"
- External Encoder Type: "JZDP-Z002" or "Resolver Absolute"

Pc09A is always specified in degrees, because it represents a backlash for rotary applications. The backlash defines a symmetrical position window from 1 to 179 degrees in positive and negative direction. In the *Advanced Safety Module Parameter Editor* the input field of this parameter is named *Position Difference*.

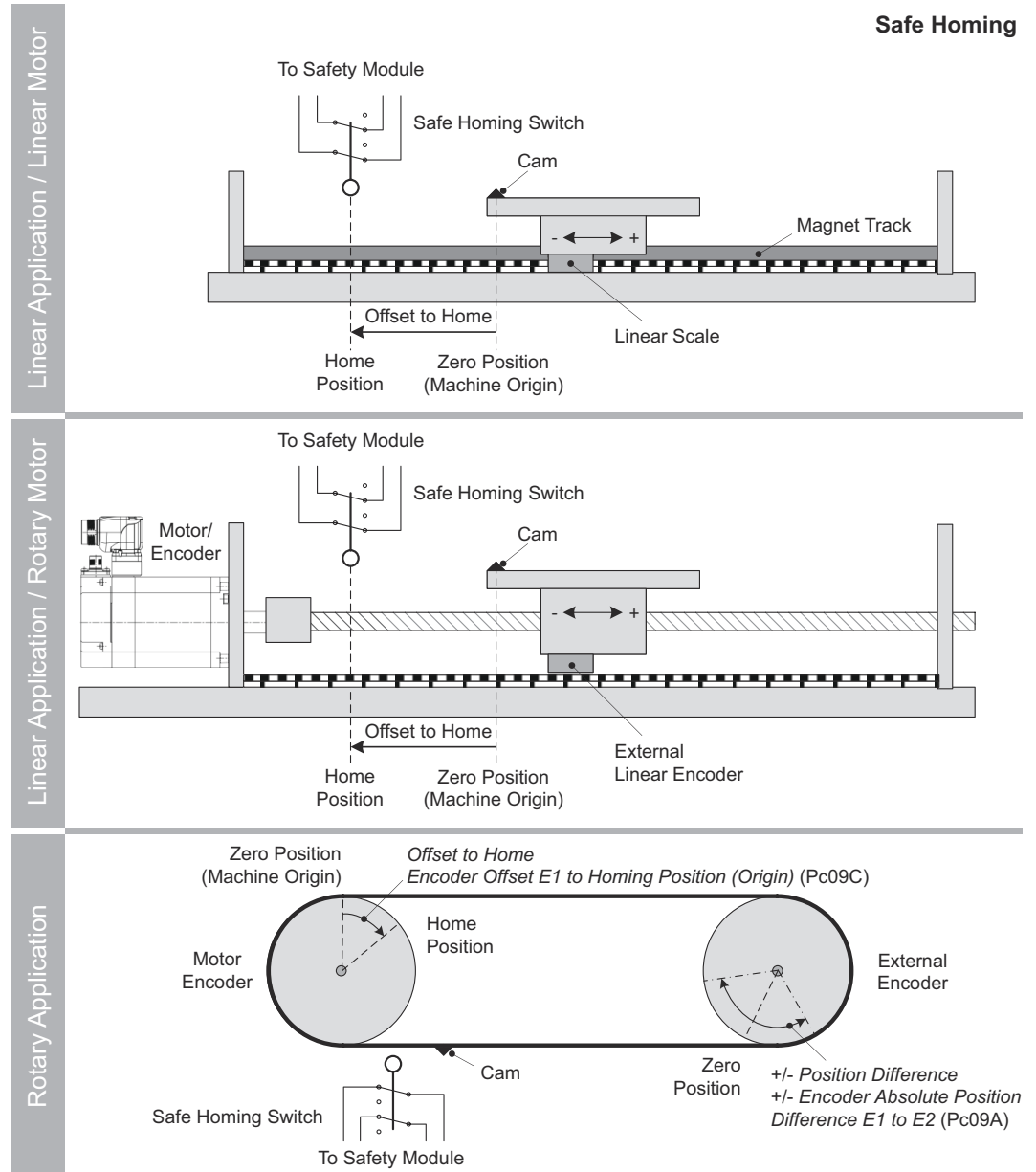

Fig. 94: Safe Homing Diagram



The encoders listed below represent the motor encoder.

Absolute Multiturn Encoder

When using an absolute multiturn encoder, the user must execute the homing procedure and the SHP function once during the initial setup of the machine.

Incremental Encoder, Absolute Singleturn Encoder

When using an incremental encoder or an absolute singleturn encoder, the user must execute the homing procedure and the SHP function each time the machine is switched on again.

Safe Home Position (SHP)

Activation Method

- Low level on the assigned safe input channel
- TRUE signal on the assigned virtual input over FSoE

Possible configurations

			Optional			Mandatory
			Possibilities to get EtherCAT Reference Position			Possibilities to get ASM7 Safe Home Position
Configuration	Encoder Setting (Pn002.2, Pc068.3)	Multiturn Limit Value (Pn205, Pc06A)	A Execute SERVO-PACK Homing Method (6098h)	B Approach machine home position and store Home Offset (607Ch) in SERVO-PACK	C Approach machine home position and perform calculation in PLC/Controller	Execute ASM7 SHP Function
1	Absolute Multiturn	= 65.535	Every Power-up *1 *2	Once *1	Once *1	Once *3 *4
2	Absolute Multiturn	≤ 65.534	Not recommended	Not recommended	Not recommended	Not recommended
3	Absolute Singleturn	0	Every Power-up *1 *2	-	Every Power-up *1	Every Power-up *4
4	Incremental	0	Every Power-up *1 *2	-	Every Power-up *1	Every Power-up *4

Motor Direction (Pn000.0, Pc050.1)	Calculations:	
	EtherCAT	Safety
CCW	*1 EtherCAT Position Actual Value after power-up := Encoder Position + Home Offset (607Ch)	*3 Safety Position Actual Value after power-up (SHP Status = TRUE) := Encoder Position - Encoder Home Position + Offset To Home (Pc09C)
	*2 EtherCAT Position Actual Value after Homing := - Home Offset (607Ch)	*4 Safety Position Actual Value after SHP := Offset To Home (Pc09C)
CW	*1 EtherCAT Position Actual Value after power-up := (-1) * (Encoder Position) + Home Offset (607Ch)	*3 Safety Position Actual Value after power-up (SHP Status = TRUE) := (-1) * (Encoder Position - Encoder Home Position) + Offset To Home (Pc09C)
	*2 EtherCAT Position Actual Value after Homing := - Home Offset (607Ch)	*4 Safety Position Actual Value after SHP := Offset To Home (Pc09C)

Examples of possible sequences for different configurations

Configuration	Further conditions	Sequence
B1 (Absolute Multiturn, Multiturn Limit (Pn205, Pc06A) = 65.535, CCW)	<ul style="list-style-type: none"> ■ Same mechanical homing position for SERVOPACK and ASM7. ■ <i>Home Offset (607Ch)</i> = 0 and <i>Offset To Home (Pc09C)</i> = 0 	<ul style="list-style-type: none"> ■ Move motor to origin of machine coordinate system. ■ Read <i>Position Actual Value (6064h)</i>. ■ Write and store (- <i>Position Actual Value (6064h)</i>) in parameter <i>Home Offset (607Ch)</i>. ■ Execute SHP with parameter <i>Offset To Home (Pc09C)</i> = 0. ■ Cycle power the SERVOPACK. ■ Run application.
A4 (Incremental, CCW)	<ul style="list-style-type: none"> ■ Same mechanical homing position for SERVOPACK and ASM7. ■ <i>Home Offset (607Ch)</i> = 0 and <i>Offset To Home (Pc09C)</i> = 0 	<ul style="list-style-type: none"> ■ Move motor to origin of machine coordinate system. ■ Execute <i>Homing Method (6098h)</i> 35 (Homing with the current position) with <i>Home Offset (607Ch)</i> = 0. ■ Execute SHP with parameter <i>Offset To Home (Pc09C)</i> = 0. ■ Run application.

11 Utility Functions

11.1 Overview

This chapter describes the utility functions related to the safety module. For details on the utility functions of the SERVOPACK, refer to the manual for your SERVOPACK.

11.2 Utility Functions for Editing Parameters

Parameters are edited using the Advanced Safety Module Parameter Editor (PC configuration tool).



SigmaWin+ does not support safety module parameter editing functions. Only the Advanced Safety Module Parameter Editor (PC configuration tool) supports parameter editing, and the safety module parameters can only be written to the safe container using this configuration tool.

11.3 Utility Functions for Setup

List of Functions for Setup (using the Digital Operator)

Contents	Fn number	Access restriction		
		By SERVOPACK		By safety module
		Write *2	SVOFF	
Reset Option Module Configuration Error	Fn014 *1	Yes	No	
Safety Option Module Access Mode Setting	Fn040	Yes	No	
Safety-related Servo Parameter Confirmation	Fn042 *1	No	No	Only reading, Fn042 can be executed only confirming.
Safety Option Module Initializing Parameter Setting	Fn043 *1	No	No	

*1. Only available if the safety module is attached to the following SERVOPACK model:

- SGD7S-□□□DA0□8□□F91 (Sigma 7 FT91 Series 400 V)

If not, these functions are not displayed on the digital operator.

*2. Utility functions with "Yes" in the Write column cannot be executed if the parameters are write prohibited (e.g. if Fn010 is set to 0001). **NO-OP** is displayed if you attempt to change to utility functions from the main menu in Utility Mode while the parameters are write-prohibited.)



SigmaWin+ supports "Reset Option Module Configuration Error" (Fn014). The Advanced Safety Module Parameter Editor supports "Safety Option Module Access Mode Setting" (Fn040), "Safety-related Servo Parameter Confirmation" (Fn042) and "Safety Option Module Initializing Parameter Setting" (Fn043).

Fn014 (Reset Option Module Configuration Error)

If the safety module was detached from the SERVOPACK, a **Safety Option Module Detection Failure (A.E71)** will occur. Also, if a different model of the safety module was connected, a **Safety Module Unmatch (A.E81)** will occur.

Example

When SGD7S-OSB01A is detached and SGD7S-OSB02A is attached.

Fn014 can be used to clear these alarms.

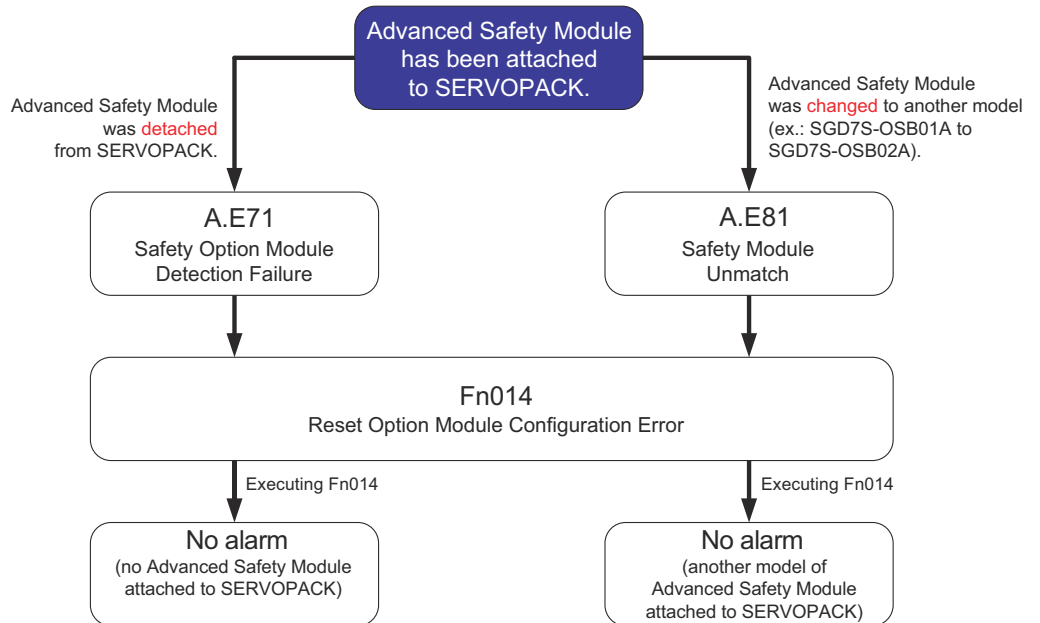

Fig. 95: Flowchart for Clearing Alarm A.E71 or A.E81

Fn040 (Safety Option Module Access Mode Setting)

Fn040 activates the editing mode of the safety module. Only after this activation is it possible to access the functions Fn042 and Fn043.

To activate this function, the last four characters of the serial number of the safety module (attached to the SERVOPACK) must be entered (range = 0001 to 9999).

Example

Serial number: D019XA12345**0001** ⇒ Password is 0001
 Serial number: D019XA12345**1234** ⇒ Password is 1234
 Serial number: D019XA12345**9999** ⇒ Password is 9999

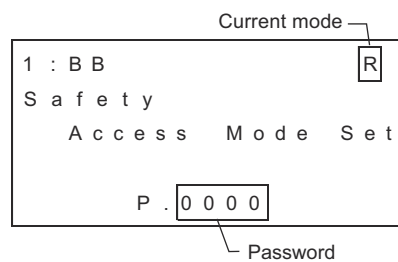





Fig. 96: Digital Operator Screen of Fn040

Current mode R: Reference mode (after power-up, the safety module is in this mode).
 E: Edit mode (after successfully entering the password, the editing mode of the safety module is activated).

Operation Procedure

Before setting the safety module access mode, check that alarm A.EB0 (Safety Module: System Malfunction) has not occurred.

1. Press the  [MODE/SET] key to display the main menu of utility function mode and select Fn040 using the  [UP] or  [DOWN] key.



```

1 : B B      - F U N C T I O N -
F n 0 3 0   S o f t   R e s e t
F n 0 4 0   S O M   M o d e S e t
F n 0 4 2   S O M   P r m C f m
F n 0 4 3   S O M   P r m I n i t
    
```





2. Press the  [DATA] key. The display switches to the Fn040 main window. The password will be displayed as “P.0000” regardless of the current access mode. The current access mode is displayed in “Current mode” as follows:

- R: Reference mode
- E: Edit mode

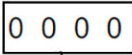

```

Current mode 
1 : B B
S a f e t y
A c c e s s   M o d e   S e t
P . 
Password
    
```

3. Press the  [LEFT],  [RIGHT], and  [UP],  [DOWN] keys to change “P.0000” (reference mode) to “P.XXXX” (edit mode).

XXXX: the last four characters of the serial number of the safety module (attached to the SERVOPACK)

Example: Serial Number D0191ABCDEF**1234** ⇒ Password is 1234

Note: Press the  [MODE/SET] key to return to the main menu of utility function mode.



```

1 : B B      R
S a f e t y
A c c e s s   M o d e   S e t
P . 1 2 3 4
    
```

4. → Press the  [DATA] key to save the set value. When the set value has been saved, "DONE" flashes in the status display for approx. one second, and the updated access mode will be displayed as "Current Mode".



- If an attempt to save the set value fails: "ERROR" flashes in the status display for approx. one second and the display returns to step 3. Attempt to save the set value again.
- If alarm A.EB0 (Safety Module: System Malfunction) occurs: **NO-OP** is displayed in the status display and "SYSTEM ERROR" flashes on the screen.
Press the  [MODE/SET] key to return to the main menu of utility function mode. Attempt to make the settings again.

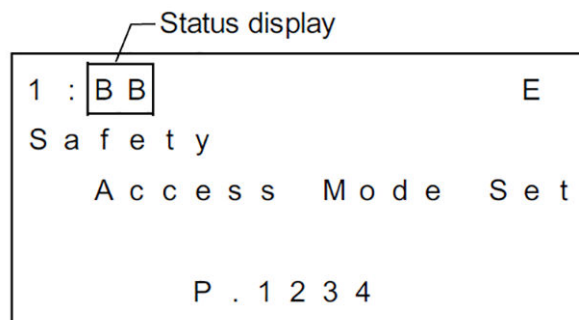

5. → Press the  [MODE/SET] key to return to the main menu of utility function mode.

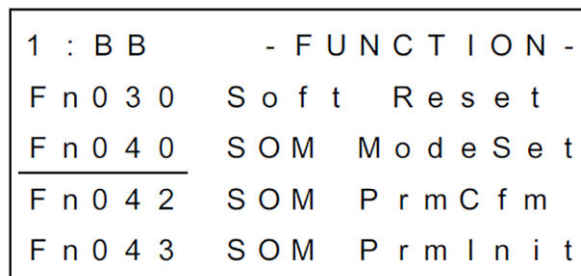

Fn042 (Safety-related Servo Parameter Confirmation)

The settings of SERVOPACK parameters related to the safety functions are managed in the safety module. These parameters are called safety-related servo parameters.

Fn042 displays unmatched parameters between SERVOPACK and the safety module with regard to the safety-related servo parameters (Pc□□□).

This function is only accessible if the editing mode is enabled using Fn040. When trying to enter into Fn042 in reference mode, **NO-OP** will be displayed.

With this function, a user can check the incorrect setting of safety-related servo parameters. However, this function supports only the display of the incorrectly set parameter. The parameter must be changed with the Advanced Safety Module Parameter Editor (PC configuration tool).

The display of the digital operator shows the following name for this function:
Fn042 SOM PrmCfm.



A list of the safety-related servo parameters that can be checked with this function can be found in [↪ 'Motor and Encoder Parameters'...page 219](#).

Alarm A.EC1 (Safety-related Servo Parameter Unmatch Alarm) is related to this function. This alarm is displayed when the settings of a safety-related servo parameter and the corresponding SERVOPACK parameter related to the safety functions do not match.

Operation Procedure

Before setting the safety module access mode, check the following:

- The servo must be OFF.
- Alarm A.EB0 (Safety Module: System Malfunction) has not occurred.
- The safety module access mode must be in "Edit mode".

1. → Press the  [MODE/SET] key to display the main menu of utility function mode and select Fn042 using the  [UP] or  [DOWN] key.



```

1 : B B      - F U N C T I O N -
F n 0 4 0   S O M   M o d e S e t
F n 0 4 2   S O M   P r m C f m
F n 0 4 3   S O M   P r m I n i t
F n 0 8 0   P o l e   D e t e c t
    
```

2. → Press the  [DATA] key.

The safety-related servo parameters are compared with corresponding SERVO-PACK parameters.

- If parameter settings do not match: As many parameter check screens as the number of mismatching parameters are created, and the first parameter check screen is displayed.
- If parameter settings match: The parameter match screen is displayed for approx. one second, and the display returns to the main menu of utility function mode.

 *If the access mode was in reference mode, this screen cannot be accessed.*



Parameter Check Screen

```



1 : B B                P r m C f m
P c X X X                1 / X
< M o t o r   S e t t i n g >
O p   = n . 0 0 0 0
S V   = n . F F F F
    
```

Parameter Match Screen

```

D O N E                P r m C f m

A l l   P a r a m e t e r s
M a t c h e d
    
```



3. Use the  [UP] or  [DOWN] keys to switch between the parameter check screens. The settings of the parameters are displayed.



```

1 : B B           P r m C f m
P c X X           1 / X
< M o t o r   S e t t i n g >
O p   = n . 0 0 0 0
S V   = n . F F F F

```

4. Press the  [MODE/SET] key to return to the main menu of utility function mode.



```

1 : B B           - F U N C T I O N -
F n 0 4 0   S O M   M o d e S e t
F n 0 4 2   S O M   P r m C f m
F n 0 4 3   S O M   P r m I n i t
F n 0 8 0   P o l e   D e t e c t

```

Fn043 (Safety Option Module Initializing Parameter Setting)

This function initializes the parameters of the safety module to the factory settings. It is used if the safety module parameters are to be initialized to the factory settings from the current settings, or if consistency of parameters cannot be achieved due to a memory error in the safety module.

If Fn043 is executed, the following sections in the non-volatile memory of the safety module are deleted:

- SERVOPACK serial number
- Homing information
- Safe container



This function is only accessible if the editing mode is enabled using Fn040. When trying to enter into Fn043 in reference mode, **NO-OP** will be displayed.

Alarm A.EB2 (Safety Module: Parameter Setting Error) is related to this function. This alarm is displayed when the settings of the safety functions do not conform to the settings of the connected motor or parameter setting is out of logical area.

Alarm A.EC0 (Safety Module: Confirmation Alarm) is related to this function. This alarm is displayed when a SERVOPACK different from the one used before has been connected.

Before setting the safety module access mode, check the following:

- The servo must be OFF.
- Alarm A.EB0 (Safety Module: System Malfunction) has not occurred.
- The safety module access mode must be in "Edit mode".

1. Press the  [MODE/SET] key to display the main menu of utility function mode and select Fn043 using the  [UP] or  [DOWN] key.



```
1 : B B      - F U N C T I O N -  
F n 0 4 2   S O M   P r m C f m  
F n 0 4 3   S O M   P r m I n i t  
F n 0 8 0   P o l e   D e t e c t  
F n 2 0 0   T u n e L v I S e t
```

2. Press the  [DATA] key to display the parameter initialization execution screen.



```
1 : B B  
S a f e t y  
   P a r a m e t e r   I n i t  
  
I N I T 1
```

3. Press the  [UP] key to display INIT5.



```
1 : B B  
S a f e t y  
   P a r a m e t e r   I n i t  
  
I N I T 5
```

4. → Press the  [DATA] key to initialise the safety module parameters. During initialisation, “Processing” flashes on menu display. When the parameters have been initialised, “DONE” flashes in the status display for approx. one second.



If an attempt to initialise the parameters fails: “ERROR” flashes in the status display for approx. one second, and the display returns to the parameter initialisation execution screen. Attempt to initialise the parameters again.



```

1 : B B
S a f e t y
   P a r a m e t e r   I n i t

      I N I T 5
  
```

5. → Press the  [MODE/SET] key to return to the main menu of utility function mode.



```

1 : B B      - F U N C T I O N -
F n 0 4 2   S O M   P r m C f m
F n 0 4 3   S O M   P r m I n i t
-----
F n 0 8 0   P o l e   D e t e c t
F n 2 0 0   T u n e L v I S e t
  
```



If alarm A.EB0 (Safety Module: System Malfunction) occurs during operation, NO-OP is displayed in the status display and “SYSTEM ERROR” flashes on the screen. Press the  [MODE/SET] key to return to the main menu of utility function mode, and make the settings again.

11.4 Utility Functions for Displaying Product Information

List of Utility Functions for Displaying Product Information (With the Digital Operator)

Contents	Fn number	Access restriction		
		By SERVOPACK		By safety module
		Write *2	SVOFF *3	
Display Software Version	Fn012	No	No	
Display SERVOPACK and Servomotor ID	Fn01E	No	No	

Fn012 (Display Software Version)

Fn012 is the software version display function for SERVOPACK, encoders and option modules.

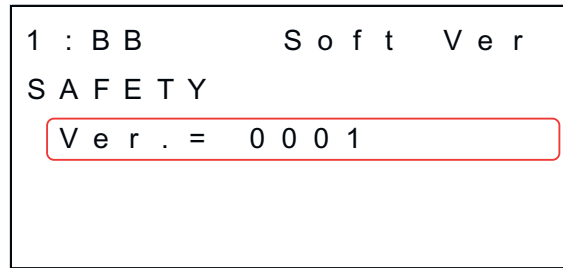

Fig. 97: Digital Operator Screen of Fn012 (SAFETY)

Display for Advanced Safety Module Software Version

Conditions	Display contents (Red part of above screen)	Remark
Not attached to SERVO-PACK	Not connect	Normal
Attached to SERVO-PACK, and the interface between SERVOPACK and safety module works correctly.	[Model : Standard model] Ver. XXXX [Model : FT model, or Y Specification model] Ver. =XXXX_YYY R XXXX: Software Version ex) 0001 YYY: FT or Y spec. number ex) 123 (Y 0123) R: FT or Y spec. software revision ex) 1: Rev=1	Normal

Fn01E (Display SERVO-PACK and Servomotor ID)

Fn01E is the function of displaying the ID of SERVOPACK, motor, encoder and option modules.

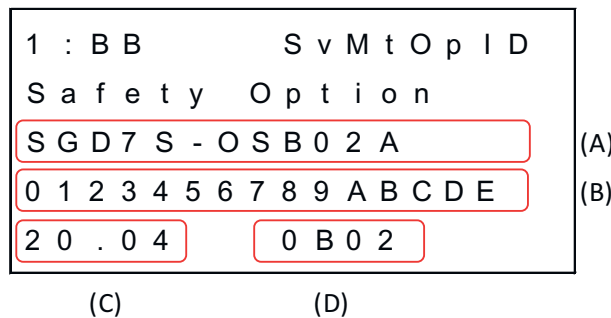

Fig. 98: Digital Operator Screen of Fn01E (SAFETY)

Display for Advanced Safety Module Product Information

Conditions	Display contents (Red part of above screen)	Remark
Not attached to SERVO-PACK	(A): Not connect (B) to (D): Blank	Normal
Attached to SERVO-PACK, and the interface between SERVOPACK and safety module works correctly.	(A) : Product name (B) : Serial number (C) : Manufacturing date [Tested year]. [Tested month] (D) : Safety Option Module ID ■ SGD7S OSB01A: 0B01 ■ SGD7S OSB02A: 0B02	Normal

12 Monitor Function

12.1 Overview

This chapter describes the monitor function that is available when a Safety Module is connected to the SERVOPACK.

The monitor function can be used

- via the Digital Operator
- via SigmaWin+
- via network (FSoE)

12.2 Monitoring Data via the Digital Operator and SigmaWin+

12.2.1 General

Additional data related to the warnings and alarms can be displayed via the Digital Operator and SigmaWin+.

Status Monitoring

The status of some safety module data can be monitored:

- digital inputs
- digital outputs
- analog input voltage
- analog input current
- analog input temperature
- position, velocity, acceleration

12.2.2 Monitor Function for SERVOPACK

Un Number	Name	Units
Un015	Safety I/O Signal Monitor	–
Un01B	Active Mode Reference Speed	Rotary [min ⁻¹] Linear [mm/s]

Safety I/O Signal Monitor

Safety I/O Signal Monitor (Digital Operator)

Digit	Signal	Logic
1	/HWBB1(CN8-3, CN8-4)	LO=Lo (Opened) HI=Hi (Closed)
2	/HWBB2(CN8-5, CN8-6)	LO=Lo (Opened) HI=Hi (Closed)
3 to 8	Reserved	Always 0

Active Mode Reference Speed

This monitor mode displays the internal speed reference of the SERVOPACK that uses the Active Mode Function.

Active Mode Reference Speed can be found in SigmaWin+ in the monitor window "Operation".

12.2.3 Monitor Function for Safety Module

12.2.3.1 User Units

The safety module has a feature of unit conversion with user defined units. Since the SERVOPACK obtains a converted value from the safety module, the SERVOPACK does not have a feature of unit conversion with user defined units.

Notation	Full name	Definition
Pos. unit	Position reference unit	The user-defined position reference unit with Pc parameter. Motor encoder : 1 [Pos. unit] = Pc072 / Pc074 [inc] External encoder : 1 [Pos. unit] = Pc076 / Pc078 [inc]
Vel. unit	Velocity reference unit	The user-defined speed reference unit with Pc parameter. Motor encoder : 1 [Vel. unit] = Pc07A / Pc07C [inc/s] External encoder : 1 [Vel. unit] = Pc07E / Pc080 [inc/s]
Acc. unit	Acceleration reference unit	The user-defined acceleration reference unit with Pc parameter. Motor encoder : 1 [Acc. unit] = Pc082 / Pc084 [inc/s ²] External encoder : 1 [Acc. unit] = Pc086 / Pc088 [inc/s ²]
inc	Encoder pulse unit	For a 24-bit encoder, the resolution is 16,777,216 [inc] per rotation. However, the safety module will scale down to 20-bit (1,048,576 [inc]) per rotation. For a linear scale, the resolution is [scale pitch] / [Number of Divisions]

12.2.3.2 Monitor Selection Method



All monitors displayed with the following devices are not safety-relevant:

- Status Display
- Digital Operator
- SigmaWin+
- EtherCAT CoE Master (via SDO access)

The safety module has 10 functional units (slots) for executing safety functions, one slot executes a safety function. It is therefore possible to execute 10 safety functions simultaneously.

An end user selects the slot to be monitored using the SERVOPACK parameter setting, then the monitor related to the safety function that is executed in the selected slot is updated. There are also monitors that are updated independently of the safety functions performed by the selected slots.

Monitor selection method:

- Selecting the target slot
Setting for Pn629=n. □□ XX

Selecting the Slot for Monitoring

When a slot of the safety module to be monitored is selected by Pn629=n.□□XX, only the monitor related to the safety function executed by the selected slot is updated.

Parameter specification of Pn629 digit 0, 1

Parameter	Meaning	When Enabled	Classification
n.□□00	No slot selected.	Immediately	Setup
n.□□01 [default setting]	Slot 1 is selected for monitoring.		
n.□□02	Slot 2 is selected for monitoring.		
n.□□03	Slot 3 is selected for monitoring.		
n.□□04	Slot 4 is selected for monitoring.		
n.□□05	Slot 5 is selected for monitoring.		
n.□□06	Slot 6 is selected for monitoring.		
n.□□07	Slot 7 is selected for monitoring.		
n.□□08	Slot 8 is selected for monitoring.		
n.□□09	Slot 9 is selected for monitoring.		
n.□□0A	Slot 10 is selected for monitoring.		

12.2.3.3 List of Monitors

Details on the listed monitors can be found in the next chapter → *'Contents of the Monitors'...page 168.*

Digital operator	EtherCAT Object Number		SigmaWin+	Units	Remark
	Index (hex)	Sub-index			
Un0A1 *4 Un0A2 *4	5A03h	1 - 14	Safety Module I/O Monitor	—	
Un0A3 *4 Un0A4 *4	5A0Bh	1	Safety Module Slot Status, Slot 1 to 4	—	
Un0A5 Un0A6	5A0Bh	1	Safety Module Slot Status, Slot 5 to 8	—	
Un0A7	5A0Bh	2	Safety Module Slot Status, Slot 9 to 10	—	
Un0A9 *4	2720h	0	Safety Module System Status	—	
Un0AC	5A0Ah	1	Safety Module: Selected Slot for Monitor	—	
Un0AD	5A0Ah	2	Safety Module: Actual Position Limit 1	Pos. unit	*1
Un0AE	5A0Ah	3	Safety Module: Actual Position Limit 2	Pos. unit	*1
Un0AF	5A0Ah	4	Safety Module: Actual Speed Limit 1	Vel. unit	*1
Un0B0	5A0Ah	5	Safety Module: Actual Speed Limit 2	Vel. unit	*1
Un0B1	5A0Ah	6	Safety Module: Actual Acceleration Limit	Acc. unit	*1
Un0B2	5A0Ah	7	Safety Module: Actual Torque Limit	*2	*1

Monitoring Data via the Digital Operator and SigmaWin+ > Monitor Function for Safety Module

Digital operator	EtherCAT Object Number		SigmaWin+	Units	Remark
	Index (hex)	Sub-index			
Un0B3	5A0Ah	8	Safety Module: Actual Temperature Limit	*3	*1
Un0B6	5A0Bh	3	Safety Module: Actual Position (Monitoring)	Pos. unit	*1
Un0B7	5A0Bh	4	Safety Module: Actual Position	Pos. unit	
Un0B8	5A0Bh	5	Safety Module: Actual Speed	Vel. unit	
Un0B9	5A0Bh	6	Safety Module: Actual Acceleration	Acc. unit	
Un0BA	5A0Bh	7	Safety Module: Actual Torque	*2	*1
Un0BB	5A0Bh	8	Safety Module: Actual Temperature	*3	*1
Un0BD	5A0Bh	9	Safety Module: Actual Position Encoder 2	Pos. unit	
Un0C0 *4	5A0Bh	10	Safety Module: SHP Status	—	
Un0C1	5A0Bh	11	Safety Module: SHP Encoder Position	Pos. unit	
Un0C2	5A0Ch	1	Safety Module: Analog Input F1	1 mV	
Un0C3	5A0Ch	2	Safety Module: Analog Input F2	1 mV	
Un0C4	5A0Ch	3	Safety Module: Analog Input G1	1 μA	
Un0C5	5A0Ch	4	Safety Module: Analog Input G2	0.1 °C	

*1: Only the selected slot can be monitored. The selected slot is shown at “Selected Slot for Monitor (Un0AC)”.

*2: Unit depends on the analog input selected in the target slot.

Data Input	Unit
Port F (0-10 V)	mV
Port G1 (4-20 mA)	μA

*3: Unit depends on the analog input selected in the target slot.

Data Input	Unit
Port F (0-10 V)	mV
Port G1 (4-20 mA)	μA
Port G2 (PT1000)	0.1 °C

*4: Detailed explanation below.

12.2.3.4 Contents of the Monitors

Safety Module I/O Monitor

I/O Monitor (SigmaWin+)

Name	Signal Name	Meaning	Remark
I/O Monitor	PIO_A1	0:OFF, 1:ON	
	PIO_A2	0:OFF, 1:ON	

Name	Signal Name	Meaning	Remark
	PIO_B1	0:OFF, 1:ON	
	PIO_B2	0:OFF, 1:ON	
	PIO_C1	0:OFF, 1:ON	
	PIO_C2	0:OFF, 1:ON	
	PIO_D1	0:OFF, 1:ON	
	PIO_D2	0:OFF, 1:ON	
	PIO_E1	0:OFF, 1:ON	
	PIO_E2	0:OFF, 1:ON	
	PIO_F1	0:OFF, 1:ON	*1
	PIO_F2	0:OFF, 1:ON	*1

*1. This bit shows 0 when PIO_F1 and PIO_F2 (Port F) are used as analog input.

The input signal monitor (Un0A1 and Un0A2) are displayed as shown below. The top indicates ON and the bottom indicates OFF.

Undefined digits are always shown as being OFF.



Fig. 99: Input Signal Monitor (Un0A1 and Un0A2)

Safety Module I/O Monitor (Digital Operator)

Name	Un Number	Display Digit Number	Signal Name	Meaning	Remark
I/O Monitor	Un0A1	1	PIO_A1	0:OFF, 1:ON	
		2	PIO_A2	0:OFF, 1:ON	
		3	PIO_B1	0:OFF, 1:ON	
		4	PIO_B2	0:OFF, 1:ON	
		5	PIO_C1	0:OFF, 1:ON	
		6	PIO_C2	0:OFF, 1:ON	
		7	PIO_D1	0:OFF, 1:ON	
		8	PIO_D2	0:OFF, 1:ON	
	Un0A2	1	PIO_E1	0:OFF, 1:ON	
		2	PIO_E2	0:OFF, 1:ON	
		3	PIO_F1	0:OFF, 1:ON	*1
		4	PIO_F2	0:OFF, 1:ON	*1
		5 to 8	Reserved	-	

*1. This bit shows 0 when PIO_F1 and PIO_F2 (Port F) are used as analog input.



SGD7S OSB01A: All bits are always 0.

PIO_G1 and PIO_G2 is only for analog input. Therefore, the status of these ports cannot be displayed with this monitor.

When a digital input is assigned, OFF means "Input circuit is open" and ON means "Input circuit is closed". When a digital output is assigned, OFF means "output transistor is off" and ON means "output transistor is on".

Safety Module Slot Status, Slot 1 to 10

Safety Module Slot Status, Slot 1 to 10 (SigmaWin+)

Name	Slot	Signal Name	Meaning
Safety Module Slot Status, Slot 1 to 10	Slot 1	Safety Function - Operating	0: Not operating 1: Operating
		Safety Function - Working Safety Function	0: Not working 1: Working safety function
		Safety Function - Limit Violation	0: Not in violation 1: After limit violation
		Safety Function - Safe State (HWBB)	0: Not operating 1: In safe state
	Slot 2 to 10	Same as slot 1	

The safety function status monitor (Un0A3 to Un0A7) are displayed as shown below. The top indicates "ON" and the bottom indicates "OFF".

Undefined digits are always shown as being OFF.



Fig. 100: Input Signal Monitor (Un0A3 to Un0A7)

Safety Module Slot Status, Slot 1 to 10 (Digital Operator)

Monitor No.	Slot	Display Digit Number	Signal Name	Meaning
Un0A3	Slot 1	1	Safety Function - Operating	0: Not operating 1: Operating
		2	Safety Function - Working SF	0: Not working 1: Working safety function
		3	Safety Function - Limit Violation	0: Not in violation 1: After limit violation
		4	Safety Function - Safe State	0: Not operating 1: In safe state
	Slot 2	5 to 8	Same as slot 1	
Un0A4	Slot 3	1 to 4		

Monitoring Data via the Digital Operator and SigmaWin+ > Monitor Function for Safety Module

Monitor No.	Slot	Display Digit Number	Signal Name	Meaning
	Slot 4	5 to 8		
Un0A5	Slot 5	1 to 4		
	Slot 6	5 to 8		
Un0A6	Slot 7	1 to 4		
	Slot 8	5 to 8		
Un0A7	Slot 9	1 to 4		
	Slot 10	5 to 8		

Safety Module System Status

This monitor shows the state of the entire safety module with slots 1 to 10 integrated.

Safety Module System Status (SigmaWin+)

Signal Name	Meaning
Safety Function - Operating	0: Not operating 1: Operating
Safety Function - Working SF	0: Not working 1: Working safety function
Safety Function - Limit Violation	0: Not in violation 1: After limit violation
Safety Function - Safe State	0: Not operating 1: Operating
Active Mode State	0: Not operating 1: Operating
External Encoder Safety Usage	0: Not used for safety application 1: Used for safety application

The safety function status monitor (Un0A9) is displayed as shown below. The top indicates "ON" and the bottom indicates "OFF".

Undefined digits are always shown as being OFF.



Fig. 101: Input Signal Monitor (Un0A9)

Safety Module System Status (Digital Operator)

Monitor No.	Display Digit Number	Signal Name	Meaning
Un0A9	1	Safety Function - Operating	0: Not operating 1: Operating
	2	Safety Function - Working SF	0: Not working 1: Working safety function

Tracing Data via SigmaWin+

Monitor No.	Display Digit Number	Signal Name	Meaning
	3	Safety Function - Limit Violation	0: Not in violation 1: After limit violation
	4	Safety Function - Safe State	0: Not operating 1: Operating
	5	Active Mode State	0: Not operating 1: Operating
	6	External Encoder Safety Usage	0: Not used for safety application 1: Used for safety application
	7 to 8	Reserved	

Safety Module: SHP Status

This monitor shows the state of Safety function SHP (Safe Home Position).

Safety Module: SHP Status (SigmaWin+)

Signal Name	Meaning
Safety Module: SHP Status	0: SHP was not completed. 1: SHP was completed normally.

The SHP status monitor (Un0C0) is displayed as shown below. The top indicates "ON" and the bottom indicates "OFF".

Undefined digits are always shown as being OFF.



Fig. 102: Input Signal Monitor (Un0C0)

Safety Module: SHP Status (Digital Operator)

Monitor No.	Display Digit Number	Signal Name	Meaning
Un0C0	1	SHP Status	0: SHP was not completed. 1: SHP was completed normally.
	2 to 8	Reserved	

12.3 Tracing Data via SigmaWin+

The log data can be read via SigmaWin+. Parameter Pn629 *Application Switch 2 for Safety Function* must be set correctly for this function to work.

When a slot of the safety module to be monitored is selected by Pn629=n.□□XX, only the monitor related to the safety function executed by the selected slot is updated.

Parameter specification of Pn629 digit 0, 1

Parameter	Meaning	When Enabled	Classification
n.□□00	No slot selected.	Immediately	Setup
n.□□01 [default setting]	Slot 1 is selected for monitoring.		

Parameter	Meaning	When Enabled	Classification
n.□□02	Slot 2 is selected for monitoring.		
n.□□03	Slot 3 is selected for monitoring.		
n.□□04	Slot 4 is selected for monitoring.		
n.□□05	Slot 5 is selected for monitoring.		
n.□□06	Slot 6 is selected for monitoring.		
n.□□07	Slot 7 is selected for monitoring.		
n.□□08	Slot 8 is selected for monitoring.		
n.□□09	Slot 9 is selected for monitoring.		
n.□□0A	Slot 10 is selected for monitoring.		



Tracing data is not safety-relevant.

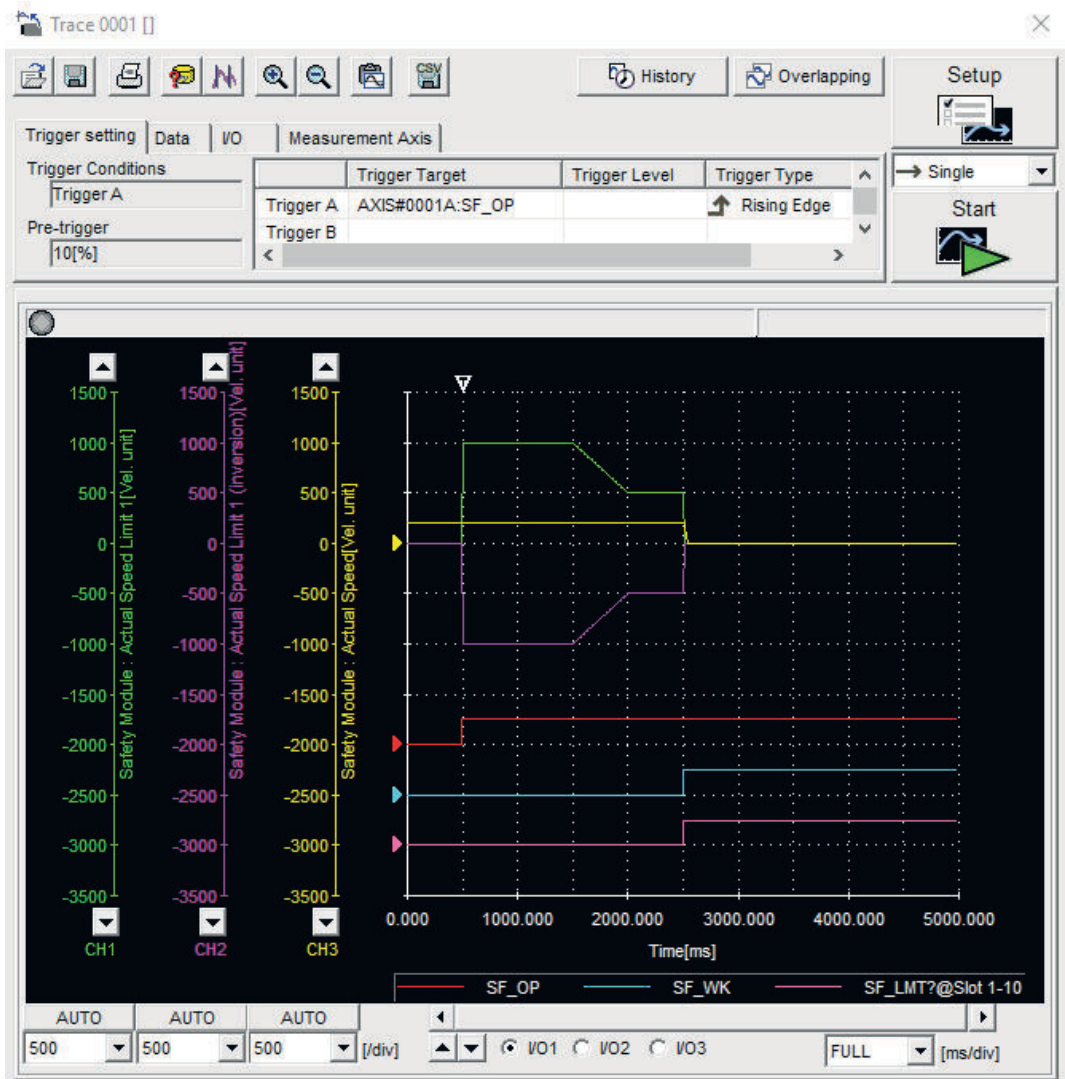

Fig. 103: Example Display for SS1-r Function (Data Trace)

Trace Data Selection

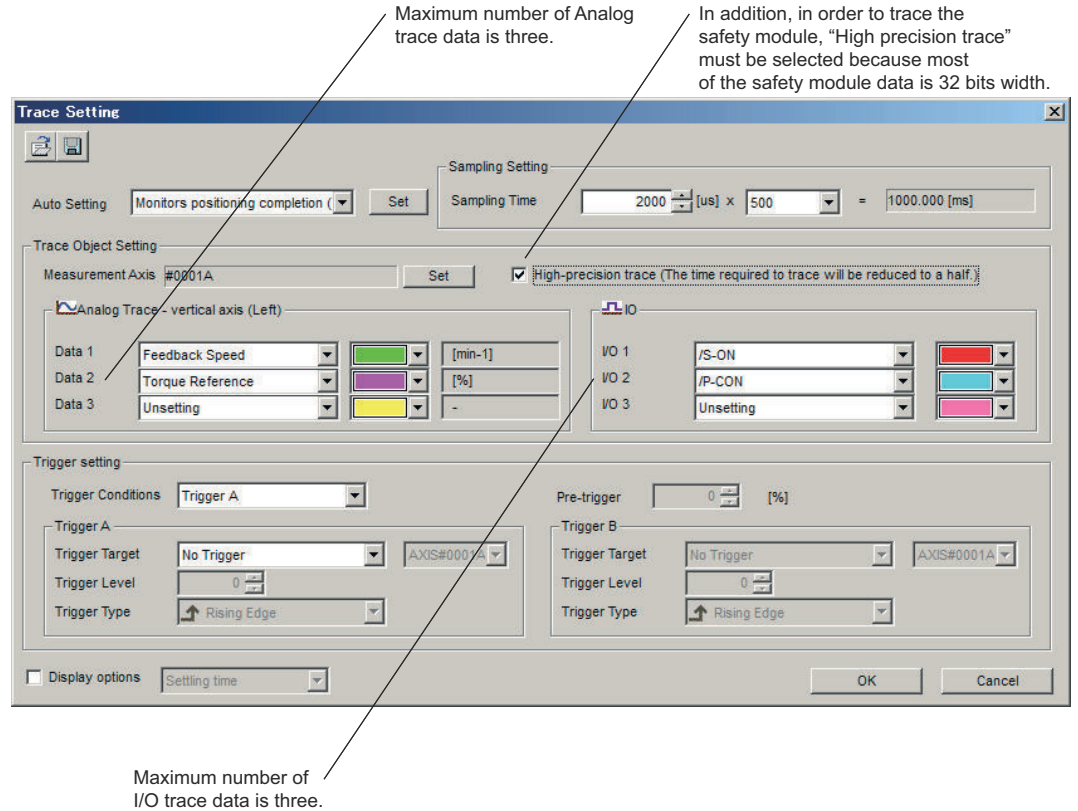

Fig. 104: Trace Setting



If you trace the data of the safety module and the data of the SERVOPACK at the same time, it is not recommended because it will display waveform shifted by several ms.

1. Select a trace target slot

When a slot of the safety module to be monitored is selected by Pn629=n.□□XX, the monitor related to the safety function executed by the selected slot can be traced.

2. Select a trace data

Select data to be traced.

Regarding selectable items are shown below.

3. Trigger setting

4. Start to trace

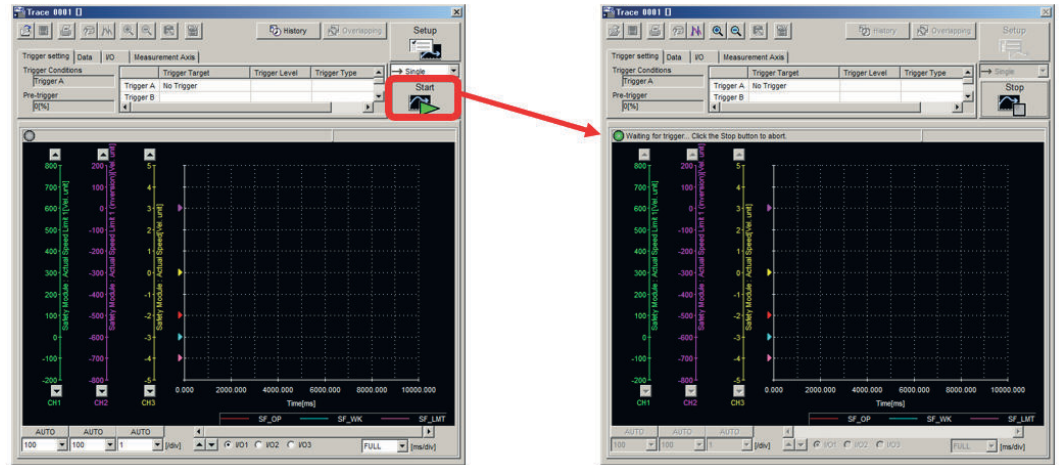

Fig. 105: Start to Trace

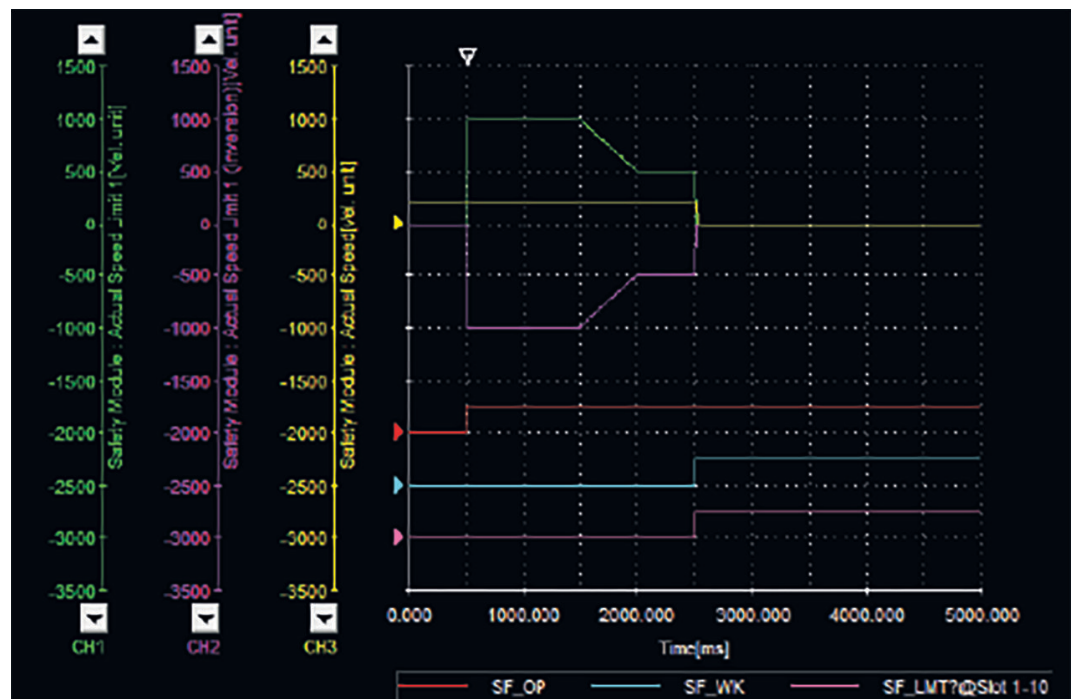

Fig. 106: Sample Waveform

Parameter No.	Parameter Name	Setting value	Remarks
Pc07A	Velocity Electronic Gear1 Ratio (Numerator)	1048576	Vel. Unit = min ⁻¹
Pc07C	Velocity Electronic Gear1 Ratio (Denominator)	60	
Pc380	Slot 2 - Configuration I	3008h	
Pc381	Slot 2 - Configuration II	2111h	
Pc390	Slot 2 - Waiting Time (t1)	50	Unit: [10ms]
Pc391	Slot 2 - Monitoring Time (t2)	500	Unit: [10ms]
Pc392	Slot 2 - Speed Limit (s1)	600	Vel. Unit = min ⁻¹
Pc394	Slot 2 - Speed Limit (s2)	50	Vel. Unit = min ⁻¹

Selectable Trace Data

- Analog trace

List of analog trace items

Name	Units
Safety Module: Actual Position Limit 1	[Pos. unit]
Safety Module: Actual Position Limit 1 (inv.)	[Pos. unit]
Safety Module: Actual Position Limit 2	[Pos. unit]
Safety Module: Actual Speed Limit 1	[Vel. unit]
Safety Module: Actual Speed Limit 1 (inv.)	[Vel. unit]
Safety Module: Actual Speed Limit 2	[Vel. unit]
Safety Module: Actual Speed Limit 2 (inv.)	[Vel. unit]
Safety Module: Actual Acceleration Limit	[Acc. unit]
Safety Module: Actual Torque Limit 1	*1
Safety Module: Actual Torque Limit 1 (inv.)	*1
Safety Module: Actual Temperature Limit	*2
Safety Module: Actual Position (Monitoring)	[Pos. unit]
Safety Module: Actual Position	[Pos. unit]
Safety Module: Actual Position Encoder 2	[Pos. unit]
Safety Module: Actual Speed	[Vel. unit]
Safety Module: Actual Acceleration	[Acc. unit]
Safety Module: Actual Torque	*1
Safety Module: Actual Temperature	*2
Safety Module: Analog Input F1	[mV]
Safety Module: Analog Input F2	[mV]
Safety Module: Analog Input G1	[μ A]
Safety Module: Analog Input G2	0.1 °C

*1: Unit depends on analog input selected in the target slot.

Data Input	Unit
Port F (0-10 V)	mV
Port G1 (4-20 mA)	μ A

*2: Unit depends on analog input selected in the target slot.

Data Input	Unit
Port F (0-10 V)	mV
Port G1 (4-20 mA)	μ A
Port G2 (PT1000)	0.1 °C

■ I/O trace

List of I/O trace items

Name	Meaning
SF_OP	0: Not in operation (System state) 1: In operation (System state)

Name	Meaning
SF_WK	0: Not in working safety function (System state) 1: In working safety function (System state)
SF_LMT	0: Not in violation (System state) 1: After limit violation (System state)
HWBB	0: Not in safe state (System state) 1: In safe state (System state)
SF_OP Slot 1-10	0: Not in operation (Selected slot information) 1: In operation (Selected slot information)
SF_WK Slot 1-10	0: Not in working safety function (Selected slot information) 1: In working safety function (Selected slot information)
SF_LMT Slot 1-10	0: Not in violation (Selected slot information) 1: After limit violation (Selected slot information)
HWBB Slot 1-10	0: Not in safe state (Selected slot information) 1: In safe state (Selected slot information)

If a limit violation occurs, the safe reaction (in general STO) will be immediately invoked directly in the Safety Module.
The limit violation message itself may be displayed with a maximum delay of 4.5 ms.
If multiple safety functions are being executed at the same time, it is recommended to use the system state flag (SF_LMT).
Do not mix the system state and the selected slot information. There is a possibility that the message timing is shifted.

12.4 Monitoring Data via Network

12.4.1 Overview

The FSoE (Fail-safe over EtherCAT) status word can be monitored via the network.

12.4.2 FSoE (Fail-Safe over EtherCAT) Technology

12.4.2.1 Overview

This chapter describes which FSoE parameters and process data are available.

12.4.2.2 General

FSoE (Fail-safe over EtherCAT) describes a communication protocol that was developed by the *EtherCAT Technology Group*. The goal was to design an industrial communication bus that would be suited for transferring safety data up to an IEC 61508 SIL3 level between FSoE devices. To put this into perspective, this means the communication bus would need to operate in excess of 100,000 years without an undetected error.

Each FSoE node receives a unique address (16-bit) and the safe data with checksum are encapsulated in the EtherCAT telegram: FSoE frames are cyclically transferred via a subordinate fieldbus that is not included in the safety considerations, since the subordinated fieldbus can be considered as a *black channel* (i. e. there is no safety related dependency to the standard communication interface). The FSoE frame exchanged between two communication partners is regarded by the subordinate fieldbus as process data.

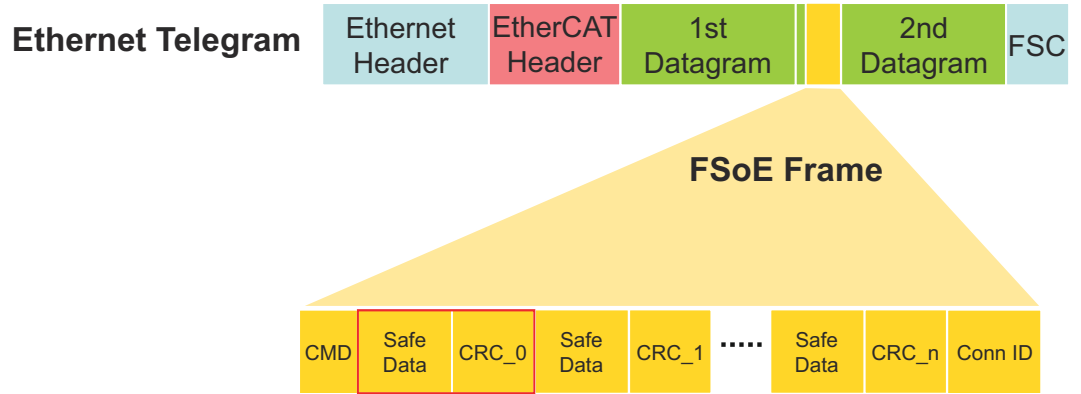

Fig. 107: FSoE Frame

FSoE uses a unique master/slave relationship between the FSoE Master and an FSoE Slave; it is called FSoE Connection. In the FSoE Connection, each device only returns its own new message once a new message has been received from the partner device. The complete transfer path between FSoE Master and FSoE Slave is monitored by a separate watchdog timer on both devices, and in each FSoE Cycle.

Each FSoE Slave is handled with a state machine. Upon start-up the slave must go through the state machine in order to set any of the safe bits. In the event of an error, the state machine is reset and the master must re-validate the connection before changing any of the safe bits.

The FSoE Master can handle more than one FSoE Connection to support several FSoE Slaves. State transitions are initiated by the FSoE Master and acknowledged by the FSoE Slave.

Key Advantages

- FSoE is certified to an IEC 61508 SIL3 level
- FSoE is an open protocol
- FSoE can be implemented with other networks
- FSoE saves wiring costs and time
- FSoE allows for Functional Safety in the Drive

12.4.2.3 FSoE Parameters and Process Data

12.4.2.3.1 General

To integrate the FSoE slave into the safety module, *FSoE parameters* and *FSoE process data* must be specified.

FSoE Parameters

Concerning FSoE parameters, the whole configuration process is performed by using a separate PC configuration tool (Advanced Safety Module Parameter Editor) (see → [‘Advanced Safety Module Parameter Editor’...page 124](#)). The configuration is downloaded and verified by the user, so that there will be a configuration file on the safety module, when the safety module starts up. The safety module can check the integrity of the configuration file on its own by using the included checksums.

Therefore, no additional FSoE user parameters are needed. Only the FSoE standard parameters are needed (basically the FSoE watchdog time and the FSoE address which must be configured in the FSoE master).

FSoE Process Data

The following section defines the FSoE process data in both directions. The drive profile is NOT supported. Only the I/O profile is used.

12.4.2.3.2 FSoE Command Frame

The FSoE process data from master to slave has a total size of 4 bytes. This leads to a total FSoE frame length of 11 bytes.

Byte 1 and 2 are used to activate the virtual inputs (VI). If a virtual input is set to "TRUE", the input is activated.

Control Process Data

Byte	Type	Contents							
		Bit 7	Bit 6	Bit 5	Bit 4	Bit 3	Bit 2	Bit 1	Bit 0
0	CMD	FSoE Master command							
1	Safe Data	VI 7	VI 6	VI 5	VI 4	VI 3	VI 2	VI 1	VI 0
2	Safe Data	VI 15	VI 14	VI 13	VI 12	VI 11	VI 10	VI 9	VI 8
3	CRC	CRC_0							
4									
5	Safe Data	FSoE Error Ack	Padding			MPD 3	MPD 2	MPD 1	MPD 0
6	Safe Data	Padding							
7	CRC	CRC_1							
8									
9	Conn ID	Connection ID							
10									

Further information can be found in chapter [↔ ...page 278](#).

Abbreviations

- VI = Virtual input
- MPD = Mapping (*MP = Mapping, D = Demand*), used to control the values shown in the process data output, [↔ 'Mapping Table'...page 181](#).
- FSoE Error Ack = Error Acknowledgment, used to reset alarms that occurred in the safety module. Refer to chapter [↔ 'List of Alarms'...page 190](#) for details on alarms possible to reset.

12.4.2.3.3 FSoE Status Frame

The FSoE process data from slave to master has a total size of 14 bytes. This leads to a total FSoE frame length of 31 bytes.

In byte 1 and 2, 16 virtual outputs (VO) are available which can be controlled by the safety function slots as status output. The virtual outputs will be set according to the current configuration (Slot X - Configuration I).

In byte 5 and 6, the 10 status outputs of the 10 safety function slots (SF) are shown. The status of the SF bits indicates whether a limit violation is active in the corresponding slot.

Additionally, the status of the physical terminals (PIO) are also put into byte 6 and 9. The bits will show the physical state of the 14 channels of the 7 terminals. Depending on the configuration, the bits will show the input or output status. The information of inputs is collected after considering the configured filter time. If the input is "24 V", the bit is set.

Starting from byte 13, two 32 bit values are transmitted. These values can show the current speed, position, acceleration or also the analog input values, if one of the input terminals F and G is used as analog or temperature input. The mapping of the two values is controlled by the 4 MPD (*MP = Mapping, D = Demand*) bits in the process input data according to the table [↔ 'Mapping Table'...page 181](#).

Status Process Data

Byte	Type	Contents							
		Bit 7	Bit 6	Bit 5	Bit 4	Bit 3	Bit 2	Bit 1	Bit 0
0	CMD	FSoE Slave command							
1	Safe Data	VO 7	VO 6	VO 5	VO 4	VO 3	VO 2	VO 1	VO 0
2	Safe Data	VO 15	VO 14	VO 13	VO 12	VO 11	VO 10	VO 9	VO 8
3	CRC	CRC_0							
4									
5	Safe Data	SF_8	SF_7	SF_6	SF_5	SF_4	SF_3	SF_2	SF_1
6	Safe Data	PIO_C2	PIO_C1	PIO_B2	PIO_B1	PIO_A2	PIO_A1	SF_10	SF_9
7	CRC	CRC_1							
8									
9	Safe Data	PIO_G 2	PIO_G 1	PIO_F2	PIO_F1	PIO_E2	PIO_E1	PIO_D2	PIO_D1
10	Safe Data	FSoE Error	SHP Status	Padding		MPA 3	MPA 2	MPA 1	MPA 0
11	CRC	CRC_2							
12									
13	Safe Data	Multi Monitor 1 Actual Value (1st word)							
14									
15	CRC	CRC_3							
16									
17	Safe Data	Multi Monitor 1 Actual Value (2nd word)							
18									
19	CRC	CRC_4							
20									
21	Safe Data	Multi Monitor 2 Actual Value (1st word)							
22									
23	CRC	CRC_5							
24									
25	Safe Data	Multi Monitor 2 Actual Value (2nd word)							
26									
27	CRC	CRC_6							
28									
29	Conn ID	Connection ID							
30									

Further information can be found in chapter [↔ ...page 280](#).

Abbreviations

- VO = Virtual output
- SF = limit violation in safety function slot

- PIO_xy = physical terminal x, channel y
- MPA = Currently active mapping (*MP = Mapping, A = Actual*)

12.4.2.3.4 Mapping Table

The "MPD" (*MP = Mapping, D = Demand*) bits control the mapping of the two 32 bit values starting from byte 13 of the process data, being sent from FSoE slave (safety module) to the master. The following mapping is used:

Multi-Monitor Actual Values

Index SI	Monitor No.	Name	Short Name *1
5A0Bh 4	Un0B7	Safety Slot Actual Value 2, Actual Position	Actual Position
5A0Bh 5	Un0B8	Safety Slot Actual Value 2, Actual Speed	Actual Speed
5A0Bh 6	Un0B9	Safety Slot Actual Value 2, Actual Acceleration	Actual Acceleration
5A0Bh 9	Un0BD	Safety Slot Actual Value 2, Actual Position Encoder 2	Actual Position Encoder 2
5A0Ch 1	Un0C2	Analog Input Actual Value, Port F1	Port F1
5A0Ch 2	Un0C3	Analog Input Actual Value, Port F2	Port F2
5A0Ch 3	Un0C4	Analog Input Actual Value, Port G1	Port G1
5A0Ch 4	Un0C5	Analog Input Actual Value, Port G2	Port G2

*1: The short names are used in the following table.

MPD 3	MPD 2	MPD 1	MPD 0	Multi Monitor 1 Actual Value (2nd word)	Multi Monitor 1 Actual Value (1st word)	Multi Monitor 2 Actual Value (2nd word)	Multi Monitor 2 Actual Value (1st word)
				Short Name	Short Name	Short Name	
0	0	0	0	Actual Speed		Actual Position	
0	0	0	1	Actual Acceleration		Actual Position	
0	0	1	0	Reserved		Actual Position	
0	0	1	1	Reserved		Actual Position	
0	1	0	0	Reserved		Actual Position	
0	1	0	1	Reserved		Actual Position	
0	1	1	0	Port F2	Port F1	Actual Position	
0	1	1	1	Port G2	Port G1	Actual Position	
1	0	0	0	Actual Position		Actual Speed	
1	0	0	1	Actual Acceleration		Actual Speed	
1	0	1	0	Port F2	Port F1	Actual Speed	
1	0	1	1	Port G2	Port G1	Actual Speed	
1	1	0	0	Reserved		Actual Speed	
1	1	0	1	Reserved		Actual Speed	
1	1	1	0	Reserved		Actual Speed	
1	1	1	1	Actual Position		Actual Position Encoder 2	

MPx stands for MPD and MPA. D = Demand and A = Actual. The monitors are set via D and can be checked via A whether they are active.

12.4.2.4 EtherCAT

According to the *EtherCAT Technology Group* specification ETG 5001.4 (specifying which objects in the standard EtherCAT object dictionary should be supported in order to be compliant), the following information must be put into the EtherCAT object dictionary:

- Index E700h showing the FSoE frame of the master frame without the process data
- Index E600h showing the FSoE frame of the slave frame, without process data
- Index E900h showing the module information (Type, Name, Device Type, Vendor ID, etc.)
- Index E901h including the FSoE connection communication parameters like watchdog time etc.
- Index EA00h including the diagnostic data like connection state and connection diagnosis
- Index F980h showing the module address

All other objects are described in → [‘Reference List of Parameters’...page 213](#).

Mapping of the RxPDO and TxPDO objects is done according to appendix A.2 of the ETG specification.

12.5 Status Display

The safety module has a green LED (LD2) to signalise normal operation without disturbance and a red LED (LD1) to signalise errors.

The different alarms and warnings have different blink codes:

Red LED (LD1)	Green LED (LD2)	Meaning
OFF	OFF	No power supply
OFF	ON	Normal operation
ON	OFF	Error of the safety module according to the error codes → ‘List of Alarms’...page 190
ON	ON	STO active
Blinking	OFF	Incorrect module exchange / Error after “pairing” the safety module with the SERVOPACK
Blinking	ON	Safety function active

13 Active Mode Function

13.1 Overview

This chapter describes the Active Mode Function, which is an additional function of the SERVOPACK available when used with the safety module.

13.2 General

Active Mode Function is used to stop the motor according to the internal deceleration reference of the SERVOPACK that is set in the parameters, when the Activation Input turns active. Two independent deceleration references can be set for the selected two safety slots.



Active Mode Function is not a safety function of the harmonized standards. Consider this when designing the system.

13.3 Basic Functions

13.3.1 Overview

The basic functions in Active Mode Function are as follows:

- Two safety slots of the safety module can be selected and linked with the active mode.
- Internal Deceleration References (Pn622, Pn623, and Pn624)
- Active Mode Hold Time (Pn625)
- Position Error Level for Releasing Active Mode (Pn626)
- Speed Reference Level for Releasing Active Mode (Pn628)

Active Mode Function can be used when the control mode is set to position control or speed control.



Do not use Active Mode Function when the control mode is set to torque control. If used, the internal elements may deteriorate leading to malfunctioning.

If the motor stops due to the operation of Active Mode Function, Active Mode Function can be canceled to return to the normal operation when all of the following conditions are met.

- *The servo ON command must be OFF.*
- *The corresponding Activation Input must be inactive.*

Restart the normal operation after Active Mode Function has been canceled.

The Active Mode Function of the safety module has the following basic features.

- Can be selected by parameter setting.
- “ACT” is shown on the status display while in Active Mode Function.
- The internal deceleration reference of the SERVOPACK can be set by the parameter.
- The deceleration reference can be separately set for selected Safety Slots, and the Active Mode Function operates for each safety function separately.
- When selected Safety Functions operate in Active Mode Function concurrently, the motor will be controlled at the lower of two speeds set as the deceleration reference.

If either of the following occurs while in Active Mode Function, the Active Mode Function will be canceled.

- The servo ready signal is OFF.
- An alarm occurs.

13.3.2 Internal Deceleration References

The parameters for the internal deceleration references in Active Mode Function are as follows:

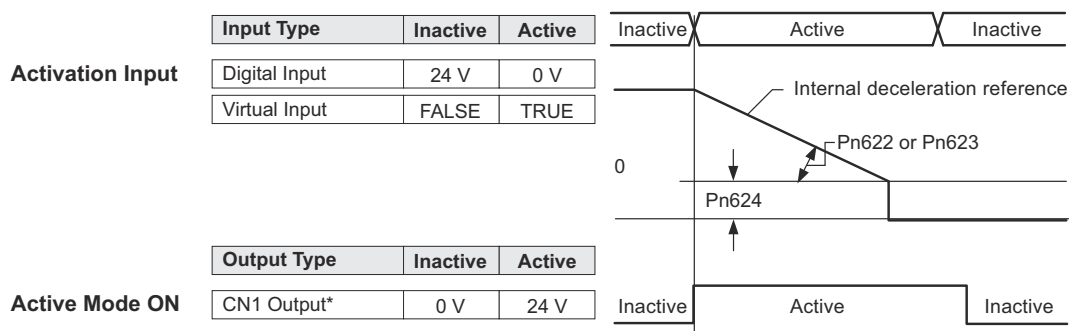

Fig. 108: Internal Deceleration References - Operation Timing

* Active Mode ON Signal Mapping → 'Output Signal Selection 7'...page 215

Parameter No.	Name	Setting Range	Units	Factory Setting	When Enabled
Pn622	Constant of Deceleration for Safety Slot related to Active Mode A	1 to 30000	Rotary motor: min^{-1}/s Linear motor: mm/s^2	10000	Immediately
Pn623	Constant of Deceleration for Safety Slot related to Active Mode B	1 to 30000	Rotary motor: min^{-1}/s Linear motor: mm/s^2	10000	Immediately
Pn624	Motor Stop Detection Level for Active Mode	0 to 10000	Rotary motor: min^{-1} Linear motor: mm/s	10	Immediately



If Active Mode is used when the control mode is set to torque control, the servo turns OFF. Stopping is performed according to the setting of Pn001.0. For details, refer to the manual for your SERVOPACK.

13.3.3 Active Mode Hold Time

After the motor stops, the motor is placed in a servolock state in Active Mode Function for a specified time in accordance with the parameter setting. Using this function, the hold time can be set for the host controller to detect if the motor has stopped.

The Active Mode Hold Time is set in Pn625. This parameter applies to the Safety Slot related to Active Mode A and the Safety Slot related to Active Mode B. Individual settings are not provided.

Parameter No.	Name	Setting Range	Units	Factory Setting	When Enabled
Pn625	Active Mode Hold Time	0 to 10000	10 ms	100	Immediately

After the motor stops, Active Mode Function continues for the Active Mode Hold Time (Pn625) regardless of the state of the Activation Input.

If the Activation Input turns inactive after the Active Mode Hold Time (Pn625) elapses, Active Mode Function is canceled.

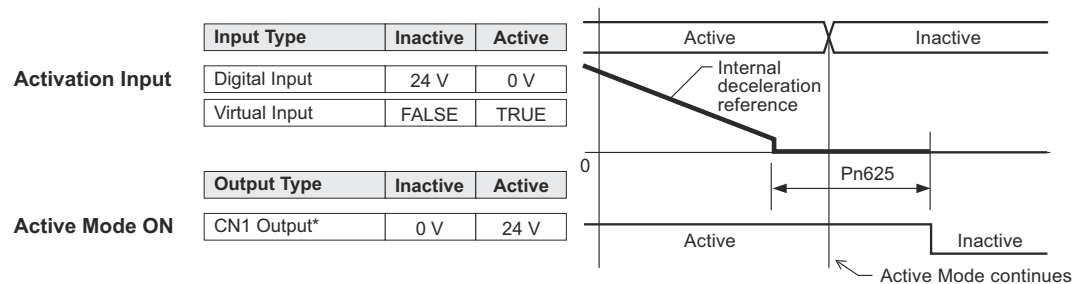

Fig. 109: Active Mode Hold Time - Operation Timing

* Active Mode ON Signal Mapping → 'Output Signal Selection 7'...page 215

13.3.4 Position Error Level for Releasing Active Mode

The Position Error Level for Releasing Active Mode prevents the motor from moving unexpectedly when position control is used as the control method and Active Mode Function is canceled.

Besides the position reference from the host controller, Active Mode Function controls the motor based on the deceleration reference from the SERVOPACK. At this point, the difference between the position reference from the host controller and the actual motor position is maintained in the SERVOPACK as the position error. While a position error remains, do not cancel Active Mode Function. This would be dangerous because the motor might move unexpectedly to clear the position error and reset the position error to zero. To avoid this, an error level can be set to cancel the Active Mode Function.

The Position Error Level for Releasing Active Mode is set in Pn626. This parameter applies to the Safety Slot related to Active Mode A and the Safety Slot related to Active Mode B. Individual settings are not provided.

Parameter No.	Name	Setting Range	Units	Factory Setting	When Enabled
Pn626	Position Error Level for Releasing Active Mode	1 to 1073741 823	1 reference unit	100	Immediately

If the position error exceeds the value set in Pn626, Active Mode Function continues to operate regardless of the state of the Activation Input.

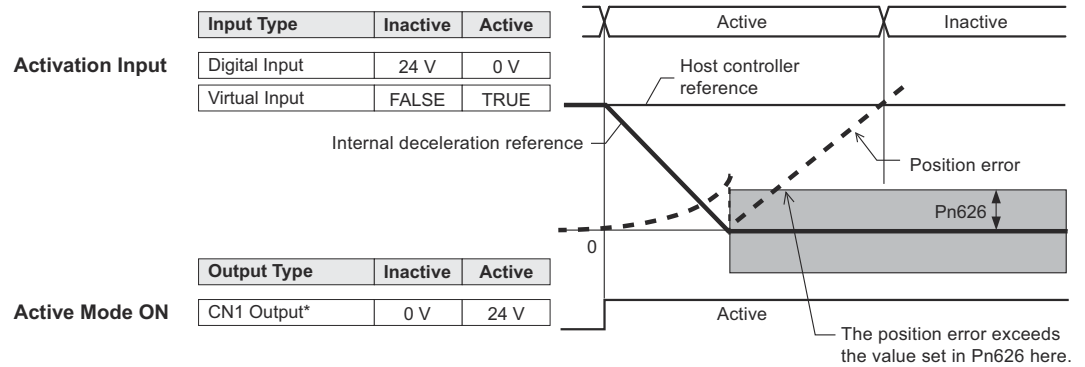

Fig. 110: Error Level for Releasing Active Mode

* Active Mode ON Signal Mapping → 'Output Signal Selection 7'...page 215

13.3.5 Speed Reference Level for Releasing Active Mode

The Speed Reference Level for Releasing Active Mode is used to prevent the sudden operation of the motor when Active Mode Function is canceled in speed control mode. Besides the speed reference from the host controller, Active Mode Function controls the motor based on the deceleration reference from the SERVOPACK. Do not cancel Active Mode Function while the motor is stopping in Active Mode Function after the speed reference from the host controller has been input. This would be dangerous because the motor might move unexpectedly. To avoid this, a speed reference level can be set to cancel the Active Mode Function.

The Speed Reference Level for Releasing Active Mode is set in Pn628. This parameter applies to the Safety Slot related to Active Mode A and the Safety Slot related to Active Mode B. Individual settings are not provided.

Parameter No.	Name	Setting Range	Units	Factory Setting	When Enabled
Pn628	Speed Reference Level for Releasing Active Mode	0 to 10000	Rotary motor: min ⁻¹ Linear motor: mm/s	10	Immediately

If the speed reference exceeds the value set in Pn628, Active Mode Function continues to operate regardless of the state of the Activation Input.

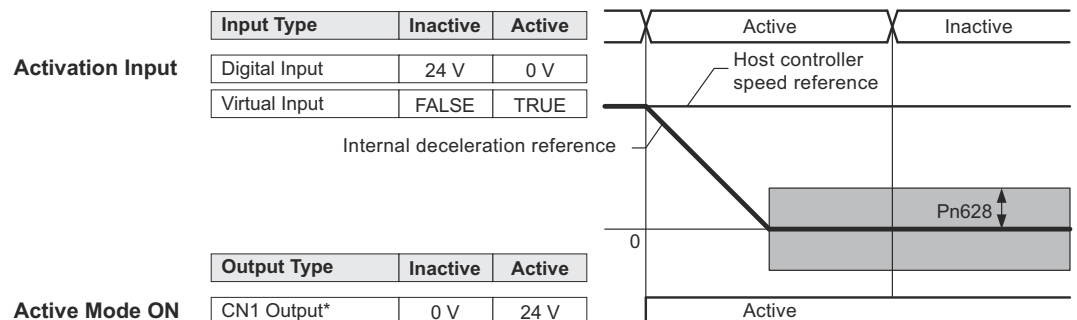

Fig. 111: Speed Reference Level for Releasing Active Mode

* Active Mode ON Signal Mapping → 'Output Signal Selection 7'...page 215

13.4 Settings

This section describes the setup parameters of Active Mode Function.

Active mode A selection

Parameter	Digit	Meaning	When Enabled	Classification
Pn62D	n.□□00 [default setting]	Active mode A is disabled.	After reset	Setup
	n.□□01	Active mode A works with Slot 1.		
	n.□□02	Active mode A works with Slot 2.		
	n.□□03	Active mode A works with Slot 3.		
	n.□□04	Active mode A works with Slot 4.		
	n.□□05	Active mode A works with Slot 5.		
	n.□□06	Active mode A works with Slot 6.		
	n.□□07	Active mode A works with Slot 7.		
	n.□□08	Active mode A works with Slot 8.		
	n.□□09	Active mode A works with Slot 9.		
	n.□□0A	Active mode A works with Slot 10.		

Active mode B selection

Parameter	Digit	Meaning	When Enabled	Classification
Pn62D	n.00□□ [default setting]	Active mode B is disabled.	After reset	Setup
	n.01□□	Active mode B works with Slot 1.		
	n.02□□	Active mode B works with Slot 2.		
	n.03□□	Active mode B works with Slot 3.		
	n.04□□	Active mode B works with Slot 4.		
	n.05□□	Active mode B works with Slot 5.		
	n.06□□	Active mode B works with Slot 6.		
	n.07□□	Active mode B works with Slot 7.		
	n.08□□	Active mode B works with Slot 8.		
	n.09□□	Active mode B works with Slot 9.		
	n.0A□□	Active mode B works with Slot 10.		

The safety functions SS1-r, SS1-t, SS2-r, SS2-t can be combined with the Active Mode. An alarm (A.EC2: Active Mode Parameter Setting Error) occurs when a safety slot for executing a safety function which cannot be combined is selected.

13.5 Return Method

Returning Conditions

When the motor stops due to the operation of the Active Mode Function, the Active Mode Function can be canceled to return to the normal operation when all of the following conditions are met.

- The corresponding Activation Input must be inactive.
- A period of time greater than the value set as the Active Mode Hold Time (Pn625) must have elapsed.

Return Method

- The following commands must be sent from the controller.
 - For Interpolated position mode: Controlword (Object 6040h) bit 8 = 1 (stop axis according to Halt option code (Object 605Dh)) or bit 4 = 0 (disable interpolation).
 - For Cyclic synchronous position/velocity mode, Profile velocity mode: Controlword (Object 6040h) bit 8 = 1 (Halt).
 - For Profile torque, Cyclic synchronous torque mode: Controlword (Object 6040h) bits 1 and 2 = 1 (Shutdown).
 - For Homing mode, Profile position mode: No conditions.



If the HWBB function has turned OFF the servo, normal operation will be enabled when the corresponding Activation Input turns inactive.

Procedure to Return to Normal Operation

1. ➤ After detecting that Statusword (Object 6041h) bit 8 is 1 (Active Mode Function being executed) or that bit 15 is 1 (safety function being executed), set Controlword (Object 6040h) bit 8 to 1 (stop axis according to Halt option code (Object 605Dh)).
2. ➤ After detecting the Activation Input is turned inactive, confirm that Statusword (Object 6041h) bit 8 is 0 (Active Mode Function execution completed) and that bit 15 is 0 (safety function execution completed), and then specify Enable operation in the Controlword (Object 6040h).
3. ➤ Execute a new motion command.

14 Troubleshooting

14.1 Overview

This chapter describes the alarms that can occur in the safety module and the methods of clearing these alarms. For details on the alarms that occur in the SERVOPACK and the methods of clearing the alarms, refer to the manual of your SERVOPACK.

14.2 Safety Precautions

Troubleshooting Precautions



DANGER

- If the safety device (molded-case circuit breaker or fuse) installed in the power supply line operates, remove the cause before you supply power to the SERVOPACK again. If necessary, repair or replace the SERVOPACK, check the wiring, and remove the factor that caused the safety device to operate.

There is a risk of fire, electric shock, or injury.



WARNING

- The product may suddenly start to operate when the power supply is recovered after a momentary power interruption. Design the machine to ensure human safety when operation restarts.

There is a risk of injury.



CAUTION

- When an alarm occurs, remove the cause of the alarm and ensure safety. Then reset the alarm or turn the power supply OFF and ON again to restart operation.

There is a risk of injury or machine damage.

- If the Servo ON signal is input to the SERVOPACK and an alarm is reset, the Servomotor may suddenly restart operation. Confirm that the servo is OFF and ensure safety before you reset an alarm.

There is a risk of injury or machine damage.

- Always insert a magnetic contactor in the line between the main circuit power supply and the main circuit power supply terminals on the SERVOPACK so that the power supply can be shut OFF at the main circuit power supply.

If a magnetic contactor is not connected when the SERVOPACK fails, a large current may flow, possibly resulting in fire.

- If an alarm occurs, shut OFF the main circuit power supply.

There is a risk of fire due to a regenerative resistor overheating as the result of regenerative transistor failure.

- Install a ground fault detector against overloads and short-circuiting or install a molded-case circuit breaker combined with a ground fault detector.

There is a risk of SERVOPACK failure or fire if a ground fault occurs.

- The holding brake on a Servomotor will not ensure safety if there is the possibility that an external force (including gravity) may move the current position and create a hazardous situation when power is interrupted or an error occurs. If an external force may cause movement, install an external braking mechanism that ensures safety.

14.3 List of Alarms

A list of alarms occurring in the safety module is shown below.

List of Alarms

Alarm Code	Alarm Name	Alarm Meaning	Servo-motor Stopping Method	Alarm Reset Possible?
A.E11	Safety Module: PIO A Error	Pulse error due to open line or short circuit on Input A	Gr. 1	Yes
A.E12	Safety Module: PIO B Error	Pulse error due to open line or short circuit on Input B	Gr. 1	Yes
A.E13	Safety Module: PIO C Error	Pulse error due to open line or short circuit on Input C	Gr. 1	Yes
A.E14	Safety Module: PIO D Error	Pulse error due to open line or short circuit on Input D	Gr. 1	Yes
A.E15	Safety Module: PIO E Error	Pulse error due to open line or short circuit on Input E	Gr. 1	Yes
A.E16	Safety Module: PIO F Error	Pulse error due to open line or short circuit on Input F	Gr. 1	Yes
A.E1F	Safety Module: Unknown Alarm	This alarm code is generated when the safety module outputs an unregistered alarm in the SERVOPACK.	Gr. 1	No
A.E28	Safety Module: FSoE Error	The Safety Module contains a wrong FSoE address. An error (e.g. transmission error) occurred on FSoE communication.	Gr. 1	Yes
A.E29	Safety Module: Internal Encoder Error	No valid encoder signal.	Gr. 1	No
A.E2A	Safety Module: Encoder Absolute Position Tolerance Exceeded	Absolute position tolerance between motor encoder and external encoder exceeded.	Gr. 1	No
A.E2B	Safety Module: Encoder Deviation	Relative encoder deviation between motor encoder and external encoder exceeded.	Gr. 1	Yes
A.E2C	Safety Module: Analog Values Exceed Allowed Channel Tolerance	Analog values (0-10 V) on port F exceed allowed channel tolerance.	Gr. 1	Yes
A.E2D	Safety Module: No Safe Homing Position	There is no homing position stored in the safety module. The requested safety function needs a homing position.	Gr. 1	Yes
A.E2F	Safety Module: Fieldbus Error	FSoE initialization error.	Gr. 1	Yes
A.E33	Safety Module: Supply Voltage Error	The internal supply voltage monitoring detected an error.	Gr. 1	No

Alarm Code	Alarm Name	Alarm Meaning	Servo-motor Stopping Method	Alarm Reset Possible?
A.E34	Safety Module: I/O Test Failed	The test of the external I/O connection failed.	Gr. 1	Yes
A.E35	Safety Module: Safety Request Error	Second channel (CPU2) safe state request	Gr. 1	Yes
A.E36	Safety Module: Temperature Limit Exceeded	Internal temperature limits of safety module exceeded.	Gr. 1	Yes

List of Related Alarms

Alarm Code	Alarm Name	Alarm Meaning	Servo-motor Stopping Method	Alarm Reset Possible?
A.E71	Safety Module Detection Failure	The presence of the safety module was not detected.	Gr. 1	No
A.E74	Safety Module Non-support	A safety module that is not supported by the SERVOPACK has been connected.	Gr. 1	No
A.E81	Safety Module Unmatch	A safety module different from the one used before has been connected.	Gr. 1	No
A.EB0	Safety Module: System Malfunction	An error occurred in the system of the safety module.	Gr. 1	No
A.EB2	Safety Module: Parameter Setting Error	The settings of the safety functions do not conform to the settings of the connected motor or parameter setting is out of logical area.	Gr. 1	No
A.EB3	HWBB Circuit Malfunction	An error occurred in the HWBB circuit of the SERVOPACK.	Gr. 1	No
A.EB9	Safety Module: Parameter Change Alarm	A safety module parameter for which the power must be turned OFF and ON again to enable the settings was changed.	Gr. 1	No
A.EC0	Safety Module: Confirmation Alarm	New, unconfigured safety module detected	Gr. 1	No
A.EC1	Safety-related Servo Parameter Unmatch Alarm	The settings of a safety-related servo parameter and the corresponding SERVOPACK parameter do not match.	Gr. 1	No
A.EC2	Active Mode Parameter Setting Error	A safety function that cannot be used together with the Active Mode Function has been selected.	Gr. 1	Yes



The method of stopping the servomotor when an alarm occurs depends on the setting of Pn001.0. The stop method in the factory settings is for using the DB. For details, refer to the manual for your SERVOPACK.

14.4 Troubleshooting of Alarms

Refer to the following tables to identify the cause of an alarm and the action to be taken. Contact your Yaskawa representative if the problem cannot be solved by the described corrective action.

Troubleshooting of Alarms

A.E11 - Safety Module: PIO A Error

Cause	Investigative Action	Corrective Action
Test Pulse error due to open line or short circuit on Input A	<ul style="list-style-type: none"> ■ Check the state of the I/O signal corresponding to Un0A1. ■ Check the wiring. ■ Check the waveform of the input signal with measuring device such as an oscilloscope. 	<ul style="list-style-type: none"> ■ Correct the wiring. ■ Make improvements in the EMC installation environment. ■ Restart the system. ■ Replace the safety module.
When either Activation Input channel A1 or A2 was activated, the other channel was not activated within the Discrepancy Time (Pc0C2).		
When either Activation Input channel A1 or A2 was deactivated, the other channel was not deactivated within the Discrepancy Time (Pc0C2).		

A.E12 - Safety Module: PIO B Error

Cause	Investigative Action	Corrective Action
Test Pulse error due to open line or short circuit on Input B	<ul style="list-style-type: none"> ■ Check the state of the I/O signal corresponding to Un0A1. ■ Check the wiring. ■ Check the waveform of the input signal with measuring device such as an oscilloscope. 	<ul style="list-style-type: none"> ■ Correct the wiring. ■ Make improvements in the EMC installation environment. ■ Restart the system. ■ Replace the safety module.
When either Activation Input channel B1 or B2 was activated, the other channel was not activated within the Discrepancy Time (Pc0CA).		
When either Activation Input channel B1 or B2 was deactivated, the other channel was not deactivated within the Discrepancy Time (Pc0CA).		

A.E13 - Safety Module: PIO C Error

Cause	Investigative Action	Corrective Action
Test Pulse error due to open line or short circuit on Input C	<ul style="list-style-type: none"> ■ Check the state of the I/O signal corresponding to Un0A1. ■ Check the wiring. ■ Check the waveform of the input signal with measuring device such as an oscilloscope. 	<ul style="list-style-type: none"> ■ Correct the wiring. ■ Make improvements in the EMC installation environment. ■ Restart the system. ■ Replace the safety module.
When either Activation Input channel C1 or C2 was activated, the other channel was not activated within the Discrepancy Time (Pc0D2).		
When either Activation Input channel C1 or C2 was deactivated, the other channel was not deactivated within the Discrepancy Time (Pc0D2).		

A.E14 - Safety Module: PIO D Error

Cause	Investigative Action	Corrective Action
Test Pulse error due to open line or short circuit on Input D	<ul style="list-style-type: none"> ■ Check the state of the I/O signal corresponding to Un0A1. ■ Check the wiring. ■ Check the waveform of the input signal with measuring device such as an oscilloscope. 	<ul style="list-style-type: none"> ■ Correct the wiring. ■ Make improvements in the EMC installation environment. ■ Restart the system. ■ Replace the safety module.
When either Activation Input channel D1 or D2 was activated, the other channel was not activated within the Discrepancy Time (Pc0DA).		
When either Activation Input channel D1 or D2 was deactivated, the other channel was not deactivated within the Discrepancy Time (Pc0DA).		

A.E15 - Safety Module: PIO E Error

Cause	Investigative Action	Corrective Action
Test Pulse error due to open line or short circuit on Input E	<ul style="list-style-type: none"> ■ Check the state of the I/O signal corresponding to Un0A2. ■ Check the wiring. ■ Check the waveform of the input signal with measuring device such as an oscilloscope. 	<ul style="list-style-type: none"> ■ Correct the wiring. ■ Make improvements in the EMC installation environment. ■ Restart the system. ■ Replace the safety module.
When either Activation Input channel E1 or E2 was activated, the other channel was not activated within the Discrepancy Time (Pc0E2).		
When either Activation Input channel E1 or E2 was deactivated, the other channel was not deactivated within the Discrepancy Time (Pc0E2).		

A.E16 - Safety Module: PIO F Error

Cause	Investigative Action	Corrective Action
Test Pulse error due to open line or short circuit on Input F	<ul style="list-style-type: none"> ■ Check the state of the I/O signal corresponding to Un0A2. ■ Check the wiring. ■ Check the waveform of the input signal with measuring device such as an oscilloscope. 	<ul style="list-style-type: none"> ■ Correct the wiring. ■ Make improvements in the EMC installation environment. ■ Restart the system. ■ Replace the safety module.
When either Activation Input channel F1 or F2 was activated, the other channel was not activated within the Discrepancy Time (Pc0EA).		
When either Activation Input channel F1 or F2 was deactivated, the other channel was not deactivated within the Discrepancy Time (Pc0EA).		

A.E1F - Safety Module: Unknown Alarm

Cause	Actions	Corrective Action
Mismatch of software version between SERVOPACK and safety module.	<ul style="list-style-type: none"> ■ Check the software version of the SERVOPACK. ■ Check the software version of the safety module. 	<ul style="list-style-type: none"> ■ Assemble only valid combinations of SERVOPACK and safety module. ■ Contact Yaskawa.

A.E28 - Safety Module: FSoE Error

Cause	Investigative Action	Corrective Action
Wrong configuration.	Check the FSoE address of the safety module and the PLC project.	Correct the FSoE address in the safety module (safe container) or PLC project.

Troubleshooting of Alarms

Cause	Investigative Action	Corrective Action
The safety module changed from FSoE state DATA to another state (RESET, SESSION, PARAMETER, CONNECTION).	<ul style="list-style-type: none"> Check the FSoE wiring. Check the PLC project. 	<ul style="list-style-type: none"> Correct the FSoE wiring. Update PLC project. <p>Note: A reset of alarm A.E28 is only possible in the FSoE state DATA. Check the FSoE state in the FSoE master. Change FSoE state to DATA before acknowledging this alarm.</p>

A.E29 - Safety Module: Internal Encoder Error

Cause	Investigative Action	Corrective Action
Encoder communication error like e.g. invalid CRC or no frame received.	Check the EMC installation environment.	<p>Follow the recommendations regarding EMC installation and grounding in the product manuals of SERVOPACK and safety module.</p> <p>Note: In case of absolute encoder will the homing information (home position, SHP bit) be deleted in case of A.E29. Execute homing again after the encoder issue was solved.</p>

A.E2A - Safety Module: Encoder Absolute Position Tolerance Exceeded

Cause	Investigative Action	Corrective Action
Mechanical connection missing or unstable.	Check mechanical connection.	Improve mechanical connection.
Encoder settings not correct.	<ul style="list-style-type: none"> Check gear ratio between motor encoder and external encoder. Check user unit settings. Check direction settings. 	<ul style="list-style-type: none"> Adjust gear ratio to 1:1. Adjust user unit settings and direction settings.
Homing position has been set and after start up the absolute position difference between motor and external encoder exceeded.	Check parameter Encoder Absolute Position Difference E1 to E2 (Pc09A).	Increase tolerance in parameter Encoder Absolute Position Difference E1 to E2 (Pc09A).
Homing data corrupt.	–	<ul style="list-style-type: none"> Execute Fn043 (Safety Option Module Initializing Parameter Setting). Replace the safety module.

A.E2B - Safety Module: Encoder Deviation

Cause	Investigative Action	Corrective Action
Mechanical connection missing or unstable.	Check mechanical connection.	Improve mechanical connection.
Encoder settings not correct.	<ul style="list-style-type: none"> Check gear ratio between motor encoder and external encoder. Check user unit settings. Check direction settings. 	Adjust gear ratio, user unit settings and direction settings.
Encoder deviation exceeded, tolerance is too small.	Check parameter Encoder Deviation (Pc097) and Encoder Deviation Window (Pc099).	Increase tolerance in Encoder Deviation (Pc097) or Encoder Deviation Window (Pc099).

A.E2C - Safety Module: Analog Values Exceed Allowed Channel Tolerance

Cause	Investigative Action	Corrective Action
The analog input values between the two channels on port F exceed allowed maximum difference.	<ul style="list-style-type: none"> ■ Check voltage on both channels. ■ Check wiring. 	Increase tolerance of Safe Port F - Channel Tolerance (Pc0EC).
	<ul style="list-style-type: none"> ■ Check parameter Safe Port F - Channel Tolerance (Pc0EC). 	

A.E2D - Safety Module: No Safe Homing Position

Cause	Investigative Action	Corrective Action
A safety function that requires an absolute position is activated (SLP, SCA) but here is no origin to refer to.	Check if a safe home position is stored in the safety module (monitor Un0C0, Safety Module: SHP status).	Perform a safe homing procedure → ' Safe Home Position (SHP) '... page 151

A.E2F - Safety Module: Fieldbus Error

Cause	Investigative Action	Corrective Action
Initialisation of the FSoE stack failed.	–	Restart the system.

A.E33 - Safety Module: Supply Voltage Error

Cause	Investigative Action	Corrective Action
A fault occurred in the safety module.	–	Replace the safety module.
A fault occurred in the SERVOPACK.	–	Replace the SERVOPACK.

A.E34 - Safety Module: I/O Test Failed

Cause	Actions	Corrective Action
A digital output does not have the expected level.	Check the wiring.	Connect an external power source to I/O connector.
I/O diagnostic failed.		
Power line (24VDC) of I/O connector is not connected to external power source.		
The external power supply is below 19.2 V.	Check the external power supply.	Connect an external power source with 24 V.
A fault occurred in the safety module.	–	Replace the safety module.

A.E35 - Safety Module: Safety Request Error

Cause	Investigative Action	Corrective Action
This alarm is set when only the second channel detects an error, e.g. the external encoder communication failed.	Check SigmaWin+ alarm history for the active alarm.	Investigate and correct the active alarm.

A.E36 - Safety Module: Temperature Limit Exceeded

Cause	Investigative Action	Corrective Action
CPU temperature exceeds 85 °C.	Check the environmental conditions and the installation conditions.	<ul style="list-style-type: none"> ■ Remove dirt and dust. ■ Restart the system. ■ Replace the safety module.
CPU1 and CPU2 temperature difference exceeds 15 °C.		

Troubleshooting of Alarms

Troubleshooting of Related Alarms

A.E71 - Safety Module Detection Failure

Cause	Investigative Action	Corrective Action
Faulty connection between the SERVOPACK and the safety module.	Check the connection between the SERVOPACK and the safety module.	Reconnect the safety module.
The safety module was removed.	–	Execute Fn014 (Reset Option Module Configuration Error), and turn the power OFF and ON again.
A fault occurred in the safety module.	–	Replace the safety module.
A fault occurred in the SERVOPACK.	–	Replace the SERVOPACK.

A.E74 - Safety Module Non-support

Cause	Investigative Action	Corrective Action
A safety module that is not supported by the SERVOPACK has been connected.	<ul style="list-style-type: none"> ■ Check the model of the connected safety module. ■ Check for models of the safety module that are supported by the SERVOPACK. 	<ul style="list-style-type: none"> ■ Install a safety module that is supported by the SERVOPACK. ■ Replace the safety module. ■ Replace the SERVOPACK.
A fault occurred in the safety module.	–	Replace the safety module.
A fault occurred in the SERVOPACK.	–	Replace the SERVOPACK.

A.E81 - Safety Module Unmatch

Cause	Investigative Action	Corrective Action
A safety module different from the one used before has been connected.	Check the model of the connected safety module.	<ul style="list-style-type: none"> ■ Execute Fn014 (Reset Option Module Configuration Error), and turn the power OFF and ON again. ■ Install the safety module that was connected before.

A.EB0 - Safety Module: System Malfunction

Cause	Investigative Action	Corrective Action
An error occurred in the system of the safety module.	–	<ul style="list-style-type: none"> ■ Restart the system. ■ Make improvements in the EMC installation environment. ■ Replace the safety module. ■ Replace the SERVOPACK.

A.EB2 - Safety Module: Parameter Setting Error

Cause	Investigative Action	Corrective Action
The settings of the safety functions do not conform to the settings of the test without motor function.	Check the set values of parameter Function Selection for Test without a Motor (Pn00C.0).	Set parameter Function Selection for Test without a Motor (Pn00C.0) to 0.
The set values of encoder output resolution, Motor Max. Speed, and Linear Scale Pitch do not conform to the linear motor that is being used.	Check the set values of Motor Max. Speed (Pc062), Linear Scale Pitch (Pc063), and Encoder Output Resolution (Pn281).	Set the appropriate values.
An error occurred in a safety module parameter.	–	<ul style="list-style-type: none"> ■ Execute Fn043 (Safety Option Module Initializing Parameter Setting). ■ Replace the safety module.

Cause	Investigative Action	Corrective Action
The downloaded parameter container does not belong to the used safety module.	–	Use a parameter container which corresponds to this safety module.
Safe input, safe output and/or analog input parameters are configured, but there is no I/O board.	–	Create and download a user parameter container without I/O configuration.
Output signal behavior for safe output is wrong configured in one/more slot configurations. This is configured as "Active during operation" or "Active during working safety function", which is not accepted for safe outputs.	–	<ul style="list-style-type: none"> ■ Change parameter Slot [1 to 10] - Configuration I (Pc300, Pc380, Pc400, Pc480, Pc500, Pc580, Pc600, Pc680, Pc700 and Pc780). ■ Change parameter Slot [1 to 10] - Configuration II (Pc301, Pc381, Pc401, Pc481, Pc501, Pc581, Pc601, Pc681, Pc701 and Pc781).
Invalid value for parameter Encoder Absolute Position Difference E1 to E2 (Pc09A) detected.	Check parameter Encoder Absolute Position Difference E1 to E2 (Pc09A).	Change parameter Encoder Absolute Position Difference E1 to E2 (Pc09A).
After parameter download an unknown parameter was detected.	Check Advanced Safety Module Parameter Editor and safety module compatibility.	Use latest version of Advanced Safety Module Parameter Editor.
A slot with a safety function different to STO, SS1-t, SS1-r, SS2-t or SS2-r is configured with a limit violation as "Activation Input" on another slot.	–	Change safety function for slot. Function to activate with limit violation signal must be STO, SS1-t, SS1-r, SS2-t or SS2-r.
A safety function STO, SS1-t, SS1-r, SS2-t or SS2-r has been configured as a follow-up function for the limit violation of the safety functions SDI or SOS.	–	The limit violation of a slot in which the SOS or SDI safety functions are configured must not be selected as the activation input of a stop function.

A.EB3 - HWBB Circuit Malfunction

Cause	Investigative Action	Corrective Action
<p>An error occurred in the HWBB circuit of the SERVOPACK.</p> <p>The EDM circuit of the SERVOPACK is broken. The detection time (12 ms) of an internal EDM signal was elapsed.</p>	–	<ul style="list-style-type: none"> ■ Restart the system. ■ Check the connection between the SERVOPACK and the safety module. ■ SGD7S-OSB02A: Check the connection of I/O connector CN21 of the safety module. ■ Replace the SERVOPACK. ■ Replace the safety module.

A.EB9 - Safety Module: Parameter Change Alarm

Cause	Investigative Action	Corrective Action
A Safety-related Module Parameter was changed.	–	<ul style="list-style-type: none"> ■ Restart the system.

A.EC0 - Safety Module: Confirmation Alarm

Cause	Investigative Action	Corrective Action
A different safety module was connected to the SERVOPACK.	–	Execute sequence described in ↔ 'Initialisation of a Safety Module Already in Operation With a New SERVOPACK'...page 147.

Warnings

Cause	Investigative Action	Corrective Action
SERVOPACK Serial Number is corrupt.	–	<ul style="list-style-type: none"> Execute Fn043 (Safety Option Module Initializing Parameter Setting). Replace the safety module.

A.EC1 - Safety-related Servo Parameter Unmatch Alarm

Cause	Investigative Action	Corrective Action
<p>The settings of a safety-related servo parameter (Pc050 to Pc06F) maintained in the safety module do not match the settings of the corresponding SERVOPACK parameter.</p> <p>A SERVOPACK parameter was changed.</p>	<ul style="list-style-type: none"> Check the safety-related servo parameters (Pc050 to Pc06F) maintained in the safety module. Check SERVOPACK parameter value of the following parameters: <ul style="list-style-type: none"> Direction Selection (Pn000.0) Encoder Usage (Pn002.2) External Encoder Usage (Pn002.3) Function Selection for Test without a Motor (Pn00C.0) Resolution calculating method of an external encoder (Pn00E.0) External Encoder Monitor Selection (Pn00E.3) Number of External Encoder Pulses (Pn23E) External Encoder Scale Pitch (Pn246) Linear Encoder Scale Pitch (Pn282) Maximum Motor Speed (Linear Motor) (Pn385) 	<p>In order to match SERVOPACK parameter value/Motor encoder setting and safe container:</p> <ul style="list-style-type: none"> change SERVOPACK parameter value change the Servomotor/encoder/external encoder recreate the safe container and download to the safety module <p>Unmatched parameters can be checked by Fn042 (Safety-related Servo Parameter Confirmation) in the digital operator → ‘Utility Functions for Setup’...page 156 and in the Advanced Safety Module Parameter Editor.</p>
The motor, encoder, or linear scale connected to the SERVOPACK was changed.	Check the encoder connection.	
The power was turned ON without connecting the encoder.		Connect an encoder.

A.EC2 - Active Mode Parameter Setting Error

Cause	Investigative Action	Corrective Action
A safety function that cannot be used together with the Active Mode Function has been selected.	Check the set values of parameters Slot [1 to 10] - Configuration I (Pc300, Pc380, Pc400, Pc480, Pc500, Pc580, Pc600, Pc680, Pc700 and Pc780) and Application Switch 3 for Safety Function (Pn62D).	<p>When the Active mode function is used, available safety function is only SS1-t, SS1-r, SS2-t and SS2-r.</p> <p>When the Active Mode Function is not used: Disable the Active Mode Function.</p>

14.5 Warnings

Warning	Name	Description
A.9C0	Safety Module: Slot 1 limit violation	A limit violation of the safety function called in Slot 1 has occurred

Warning	Name	Description
A.9C1	Safety Module: Slot 2 limit violation	A limit violation of the safety function called in Slot 2 has occurred
A.9C2	Safety Module: Slot 3 limit violation	A limit violation of the safety function called in Slot 3 has occurred
A.9C3	Safety Module: Slot 4 limit violation	A limit violation of the safety function called in Slot 4 has occurred
A.9C4	Safety Module: Slot 5 limit violation	A limit violation of the safety function called in Slot 5 has occurred
A.9C5	Safety Module: Slot 6 limit violation	A limit violation of the safety function called in Slot 6 has occurred
A.9C6	Safety Module: Slot 7 limit violation	A limit violation of the safety function called in Slot 7 has occurred
A.9C7	Safety Module: Slot 8 limit violation	A limit violation of the safety function called in Slot 8 has occurred
A.9C8	Safety Module: Slot 9 limit violation	A limit violation of the safety function called in Slot 9 has occurred
A.9C9	Safety Module: Slot 10 limit violation	A limit violation of the safety function called in Slot 10 has occurred



Alarms and Warnings will be displayed to the user via the blink code of the LED's.

15 Maintenance and Repair

15.1 Safety Precautions

Maintenance and Inspection Precautions



DANGER

- Do not change any wiring while power is being supplied. There is a risk of electric shock or injury.



WARNING

- Wiring and inspections must be performed only by qualified engineers. There is a risk of electric shock or product failure.



CAUTION

- Wait for six minutes after turning OFF the power supply and then make sure that the CHARGE indicator is not lit before starting wiring or inspection work. Do not touch the power supply terminals while the CHARGE lamp is lit after turning OFF the power supply because high voltage may still remain in the SERVOPACK. There is a risk of electric shock.
- Before you replace a SERVOPACK, back up the settings of the SERVOPACK parameters. Copy the backed up parameter settings to the new SERVOPACK and confirm that they were copied correctly. If you do not copy backed up parameter settings or if the copy operation is not completed normally, normal operation may not be possible, possibly resulting in machine or equipment damage.



NOTICE

- Discharge all static electricity from your body before you operate any of the buttons or switches inside the front cover of the SERVOPACK. There is a risk of equipment damage.

15.2 Maintenance

Maintenance

If you are complying with the mandatory environmental conditions, see [↔ 'Environmental Conditions'...page 42](#), then the safety module is maintenance-free.

A defective safety module cannot be repaired (see [↔ 'Repair'...page 200](#)).



CAUTION

The safety module does not require a proof-test before the expiration of the mission time. After this time it must be put out of operation and must be disposed of properly (see [↔ 'Safety-Related Parameters for an Operation of 20 Years'...page 29](#)).

15.3 Repair

Repair

You cannot repair a defective safety module. Please contact YASKAWA Europe GmbH for a replacement.

16 Disassembly and Storage

16.1 Overview

This chapter describes how to decommission and to store the safety module.

16.2 Safety Precautions

Storage and Transportation Precautions



CAUTION

- Do not place an excessive load on the product during storage and transportation. (Follow all instructions on the packages.)
There is a risk of injury or damage.



NOTICE

- Do not install or store the product in any of the following locations.
 - Locations that are subject to direct sunlight
 - Locations that are subject to ambient temperatures that exceed product specifications
 - Locations that are subject to relative humidities that exceed product specifications
 - Locations that are subject to condensation as the result of extreme changes in temperature
 - Locations that are subject to corrosive or flammable gases
 - Locations that are near flammable materials
 - Locations that are subject to dust, salts, or iron powder
 - Locations that are subject to water, oil, or chemicals
 - Locations that are subject to vibration or shock that exceeds product specifications
 - Locations that are subject to radiation

If you store or install the product in any of the above locations, the product may fail or be damaged.
- Do not subject connectors to shock.
There is a risk of faulty connections or damage.
- If disinfectants or insecticides must be used to treat packing materials such as wooden frames, plywood, or pallets, the packing materials must be treated before the product is packaged, and methods other than fumigation must be used.

Example: Heat treatment, where materials are kiln-dried to a core temperature of 56°C for 30 minutes or more.

If the electronic products, which include stand-alone products and products installed in machines, are packed with fumigated wooden materials, the electrical components may be greatly damaged by the gases or fumes resulting from the fumigation process. In particular, disinfectants containing halogen, which includes chlorine, fluorine, bromine, or iodine can contribute to the erosion of the capacitors.

16.3 Safety Regulations



Follow the chapter → 'Safety Precautions'...page 24.



CAUTION

Damage through electrical destruction.

The component assembly can be destroyed by electricity if it is removed when the power is turned on.

Therefore:

- Make sure that the power to all electrical connections is shut off and secured to prevent from being turned back on.
- Using suitable measuring equipment, check to make sure that none of the connections are carrying live current before beginning work on the electrical connections.
- Only disassemble the connections and remove the connection once you are completely certain that the component assembly is not under power.



WARNING

Danger of injury due to uncontrollable behavior of the machine/line.

The behavior of the machine/line can change as a result of removing the component assembly with the power source connected.

Therefore:

- Make sure that the power to all electrical connections is shut off and secured to prevent from being turned back on.
- Using suitable measuring equipment check, to make sure, that none of the connections are carrying live current before beginning work on the electrical connections.
- Only disassemble the connections and remove the connection once you are completely certain that the component assembly is not under power.
- Hanging loads could disconnect unexpectedly and fall, because STO is enabled during the removing of the assembly group.

16.4 Requirements on the Personnel Conducting the Work

The functional safety specialist who is assigned to carry out the disassembly must have the knowledge and training which is necessary to perform this work properly. He must be able to understand and use the safety instructions attached to the device and its components as well as the connections.

16.5 Disassembly

The personnel carrying out the disassembly must meet the requirements above.

Carry out the disassembly process in the following order:

1. Make sure that the power has been disconnected and cannot be turned back on accidentally.
2. Disassemble the safety module in the reverse order of the assembly (see Instruction Manual).

Name	Manual number
Advanced Safety Module for Sigma-7 SERVO-PACKs with 400 V Input Power Instruction Manual	TOMP YEJOS7S 01

3. Document the disassembly (or replacement) of the safety module.
4. Document the disassembly (or replacement) of the SERVOPACK, if applicable.

5. → Document the disassembly (or replacement) of the additional system components, if applicable.

16.6 Storage Conditions

Store the safety module in an adequate package with regard to the storage conditions specified in → [‘Environmental Conditions’...page 42](#).

16.7 Recommissioning

If you want to put the safety module back into operation, observe the specifications under → [‘Storage Conditions’...page 203](#). Then follow the procedure in → [‘Set-Up and Replacement of the Safety Module’...page 140](#).

17 Disposal

17.1 Overview

This chapter describes the proper and safe disposal of the safety module.

17.2 Safety Precautions

Disposal Precautions

When disposing of the product, local ordinances and national laws must be observed. Implement all labeling and warnings as a final product as required.

17.3 Safety Regulations

The disposal may only be conducted in compliance with the safety regulations. Observe special local regulations, if applicable. If you are not able to conduct the disposal, hire a suitable waste removal company to do so.

17.4 Requirements on the Personnel Conducting the Work

The functional safety specialist who is assigned to carry out the disposal must have the knowledge and training which is necessary to perform this work properly. He must be able to understand and use the safety instructions attached to the device and its components as well as the connections.

17.5 Disposal Instructions

Prerequisites

- The safety module has already been disassembled properly, see → [‘Disassembly and Storage’...page 201](#).
- Before disposing of the product, destroy its functionality.

Sheet Steel

- Parts of the module are made of galvanized sheet steel. Sheet steel must be put into the cycle of potential recyclables for ferrous metals.

Electronic Scrap

- Electronic scrap (circuit boards), which cannot be disassembled, must be disposed of as special waste. Observe the applicable regulations in doing so.
The marking of the product with the crossed-out wheeled bin symbol means that the product should be sent to the recycling system at the end of its life. You should dispose of it separately at an appropriate collection point and not put it in the normal waste stream.

Plastic

- The housing is made of plastic. Plastic must be put into the cycle of potential recyclables for plastics.

17.6 Recycling Collection Center/Offices

Make sure that the disposal is carried out in compliance with your company's disposal guidelines as well as those of the competent recycling collection centers and offices. In the event of uncertainty, contact the industrial inspectorate, who is responsible for your company or the environmental agency.

18 Revision History

The revision dates and numbers of the revised manuals are given on the bottom of the back cover.

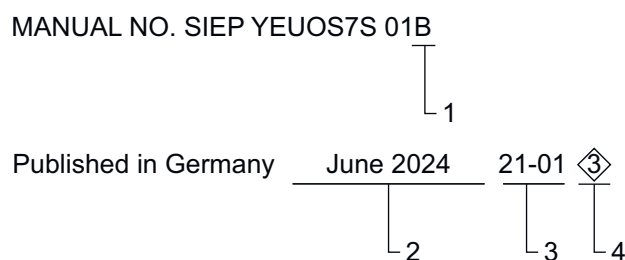

- 1 Manual version
- 2 Date of publication
- 3 Date of original publication
- 4 Revision number

Date of publication	Manual version	Rev. no.	Section	Revised content
July 2024	B	3	1.7 Approvals, Directives and Standards	Updated information on the EN IEC 62061 standard
June 2024	B	2	1.7 Approvals, Directives and Standards	More detailed information on the EN IEC 62061 standard
			4.5 Allowed compatible software versions	Updated information on the compatible software versions
April 2024	B	1	1.7 Approvals, Directives and Standards	Chapter slightly revised
			9.2.2 General Device Parameters	Chapter slightly revised
April 2024	B	0	1.5 Technical Terms and Abbreviations	Chapter slightly revised
			1.7 Approvals, Directives and Standards	Chapter revised
			4.5 Allowed compatible software versions	New chapter
			6.6 Digital Input Configuration and Operation	Chapter slightly revised
			6.8.1 Output Signal Behavior (Transition) of a Virtual Output, an EDM Output and a (Safe) Digital Output	Chapter revised
			8.2.1 General	Functional description of the safety functions updated
			8.3 to 8.18 (Safety functions)	Chapters revised
			8.19 Priority of Safety Functions	Chapter revised
			8.20 Output Signal Behavior	Chapter revised
			9.2.2 General Device Parameters	Chapter revised
			9.2.9 Parameter Validation and Safe Container Creation	Chapter revised
			9.3.3 Safety-Related Servo Parameters	Chapter slightly revised
			10.6 Safe Home Position (SHP)	Chapter revised
			12.2.2 Monitor Function for SERVOPACK	Chapter slightly revised
			12.2.3.2 Monitor Selection Method	Chapter slightly revised
			12.2.3.3 List of Monitors	Restructured chapter

Date of publication	Manual version	Rev. no.	Section	Revised content
			13.3.2 Internal Deceleration References	Chapter revised
			13.3.3 Active Mode Hold Time	Chapter revised
			13.3.4 Position Error Level for Releasing Active Mode	Chapter revised
			13.3.5 Speed Reference Level for Releasing Active Mode	Chapter revised
			13.5 Return Method	Chapter revised
			14.4 Troubleshooting of Alarms (A.EB2 - Safety Module: Parameter Setting Error)	Description of the alarm revised
			18 Revision history	Chapter updated with the revised content
			Appendix A.1.1 Detailed Parameter Description of SERVOPACK Parameters (Pn)	Chapter revised
			Appendix A.2 Safe Parameters	Chapter revised
			Appendix A.2.1 General Device Parameters	Chapter revised
			Appendix A.2.2.1 Detailed Parameter Description of Motor and Encoder Parameters	Chapter revised
			Appendix A.2.4 I/O Configuration Parameters	Chapter revised
			Appendix A.3.1.1 Detailed Parameter Description of Communication Objects	Chapter revised
			Appendix A.4.1 Detailed Parameter Description of Monitoring Parameters	Chapter revised
December 2022	A	3	12.2.3.2 Monitor Selection Method	Parameter designations updated
			12.4.2.3.2 FSoE Command Frame	Parameter designations updated
			12.4.2.3.3 FSoE Status Frame	Parameter designations updated
			18 Revision history	Chapter updated with the revised content
			Appendix A.2.2 Motor and Encoder Parameters	Parameter designations updated
			Appendix A.3.1 Communication Objects	Parameter designations updated
			Appendix A.3.2.1 Tx Process Data	Parameter designations updated
			Appendix A.3.2.2 Rx Process Data	Parameter designations updated
			Appendix A.4 Monitoring Parameters	Parameter designations updated
			Appendix B.2 EtherCAT Communication Objects	Parameter designations updated
			Appendix B.3 Application Objects	Parameter designations updated
September 2021	A	2	1.5 Technical Terms and Abbreviations	Chapter slightly revised
			3.2 Safety-Related Parameters for an Operation of 20 Years	Chapter slightly revised
			5.2 General	Information on downloading, installing and activating the Advanced Safety Module Parameter Editor added

Date of publication	Manual version	Rev. no.	Section	Revised content
			6.4 System Configuration Diagram	Information concerning CN8 added
			6.6 Digital Input Configuration and Operation	Chapter slightly revised
			6.8 Digital Output Configuration and Operation	Chapter slightly revised
			7.5.1 Limitations on the Use of the Test Without Motor Function	Chapter slightly revised
			7.6.4 Configuration of the Motor and Encoder	Chapter slightly revised
			8 Safety Functions	Chapter slightly revised
			9.2.2 General Device Parameters	Chapter slightly revised
			9.2.9 Parameter Validation and Safe Container Creation	Chapter slightly revised
			9.3.2.1 Overview	Chapter slightly revised
			10.2 Initial Set-Up of a New Safety Module With a New SERVOPACK	Chapter slightly revised
			10.4.1.2 Initialisation of a New Safety Module (Different Type) With a SERVOPACK Already in Operation	Chapter slightly revised
			11.3 Utility Functions for Setup	Chapter slightly revised
			12.2.2 Monitor Function for SERVOPACK	Chapter slightly revised
			12.2.3 Monitor Function for Safety Module	Chapter slightly revised
			12.3 Tracing Data via SigmaWin+	Chapter slightly revised
			12.4 Monitoring Data via Network	Chapter completely revised
			14.3 List of Alarms	Chapter slightly revised
			14.4 Troubleshooting of Alarms	Chapter slightly revised
			15.3 Repair	Chapter slightly revised
			18 Revision history	Chapter updated with the revised content
			Appendix A.2 Safe Parameters	Chapter completely revised
			Appendix A.3 FSoE Parameters	Chapter completely revised
			Appendix A.4 Monitoring Parameters	Chapter completely revised
			Appendix B EtherCAT Object List	Chapter completely revised
August 2021	A	1	1.1 Information About This Operating Manual	Chapter slightly revised
			1.5 Technical Terms and Abbreviations	Chapter moved here from appendix A and slightly revised
			1.9 Data Types	Chapter slightly revised
			2.4 Intended use	Chapter slightly revised
			3.2 Safety-Related Parameters for an Operation of 20 Years	Chapter completely revised
			4.4 Nameplate (Ratings) and Model Designation	Chapter slightly revised

Date of publication	Manual version	Rev. no.	Section	Revised content
			5.2 General	Chapter slightly revised
			5.4 Safety Module Variants	Chapter slightly revised
			5.5 Basic Specification of the Advanced Safety Module	Chapter slightly revised
			5.6 Typical Reaction Time	Safety Response Time (with FSoE) added
			6 Wiring and Connection	Chapter completely revised
			7.4.2 Risk assessment	Warning notice updated
			8.2.2 Safety functions selection	Chapter slightly revised
			9.2.5 I/O Configuration Parameters	<i>Safe Port Function Capability</i> table updated to <i>I/O Port Function Types</i>
			9.2.6 Safety Functions	Figure 77 updated
			14.4 Troubleshooting of alarms	Chapter slightly revised
			18 Revision history	Chapter updated with the revised content
			Appendix A Reference List of Parameters	Chapter completely revised
			Appendix B EtherCAT Object List	Chapter completely revised
January 2021	A	0	-	First edition

19 Appendix

Appendix

A	Reference List of Parameters	213
A.1	SERVOPACK Parameters (Pn)	213
A.1.1	Detailed Parameter Description of SERVOPACK Parameters (Pn)	214
A.2	Safe Parameters	217
A.2.1	General Device Parameters	218
A.2.2	Motor and Encoder Parameters	219
A.2.3	User Unit and Encoder Parameters	231
A.2.4	I/O Configuration Parameters	237
A.2.5	Slot Parameters	241
A.3	FSoE Parameters	258
A.3.1	Communication Objects	258
A.3.2	Process Data Objects	266
A.3.3	FSoE Device Information Objects	270
A.4	Monitoring Parameters	271
A.4.1	Detailed Parameter Description of Monitoring Parameters	273
B	EtherCAT Object List	278
B.1	Module Information Objects	278
B.2	EtherCAT Communication Objects	278
B.3	Application Objects	285
C	Device Combinations	310

A Reference List of Parameters

A.1 SERVOPACK Parameters (Pn)

SERVOPACK Parameters (Pn)

Parameter No.	Index (hex)	Sub-index	Parameter Name	Direct Link
Pn00E	200Eh	0	Application Function Selections E	↪ 'Application Function Selections E'...page 214
Pn23E	223Eh	0	Number of External Encoder Pulses	↪ 'Number of External Encoder Pulses'...page 214
Pn246	2246h	0	External encoder Scale pitch	↪ 'External encoder Scale pitch'...page 214
Pn518	2518h	0	Output Signal Selection 7	↪ 'Output Signal Selection 7'...page 215
Pn622	2622h	0	Constant of Deceleration for Safety Function A	↪ 'Constant of Deceleration for Safety Function A'...page 215
Pn623	2623h	0	Constant of Deceleration for Safety Function B	↪ 'Constant of Deceleration for Safety Function B'...page 215
Pn624	2624h	0	Motor Stop Detection Level for Active Mode	↪ 'Motor Stop Detection Level for Active Mode'...page 215
Pn625	2625h	0	Active Mode Hold Time	↪ 'Active Mode Hold Time'...page 215
Pn626	2626h	0	Position Error Level for Releasing Active Mode	↪ 'Position Error Level for Releasing Active Mode'...page 216
Pn628	2628h	0	Speed Reference Level for Releasing Active Mode	↪ 'Speed Reference Level for Releasing Active Mode'...page 216
Pn629	2629h	0	Application Switch 2 for Safety Function	↪ 'Application Switch 2 for Safety Function'...page 216
Pn62D	262Dh	0	Application Switch 3 for Safety Function	↪ 'Application Switch 3 for Safety Function'...page 217

SERVOPACK Parameters (Pn) > Detailed Parameter Description of SERVOPACK Parameters (Pn)

A.1.1 Detailed Parameter Description of SERVOPACK Parameters (Pn)

Application Function Selections E

Parameter No.	Size	Setting Range	Setting Unit	Default Setting	Applicable Motors	When Enabled	Classification
Pn00E (200Eh)	2	0000h to 4001h	–	0000h	All	After restart	Setup

n.□□□X	Resolution calculating method of an external encoder	
0	Linear scale: Use Pn246 or set value inside a scale.	
1	Rotary encoder: Use the number of external encoder pulses (Pn23E)	

n.X□□□	External Encoder Monitor Selection	
0	Do not use the external encoder monitor.	
1	Use CCW as the forward direction. Use the direction in which the linear encoder counts up as the forward direction.	
2	Reserved setting (Do not use.)	
3	Use CCW as the reverse direction. Use the direction in which the linear encoder counts up as the reverse direction.	
4	Reserved setting (Do not use.)	

Number of External Encoder Pulses

Parameter No.	Size	Setting Range	Setting Unit	Default Setting	Applicable Motors	When Enabled	Classification
Pn23E (223Eh)	4	0 to 16777216	1 P/Rev	0	All	After restart	Setup

External encoder Scale pitch

Parameter No.	Size	Setting Range	Setting Unit	Default Setting	Applicable Motors	When Enabled	Classification
Pn246 (2246h)	4	0 to 6553600	0.01 μm	0	All	After restart	Setup

Output Signal Selection 7

Parameter No.	Size	Setting Range	Setting Unit	Default Setting	Applicable Motors	When Enabled	Classification
Pn518 (2518h)	2	0000h to 0006h	–	0000h	All	After restart	Setup

n.□□XX	Active Mode ON Signal Mapping
00	Disabled.
01	Outputs the signal from CN1-1,-2 terminal.
02	Outputs the signal from CN1-23,-24 terminal.
03	Outputs the signal from CN1-25,-26 terminal.
04	Outputs the signal from CN1-27,-28 terminal.
05	Outputs the signal from CN1-29,-30 terminal.
06	Reserved parameter (Do not change.)

Constant of Deceleration for Safety Function A

Parameter No.	Size	Setting Range	Setting Unit	Default Setting	Applicable Motors	When Enabled	Classification
Pn622 (2622h)	2	1 to 30000	Rotary motor: min ⁻¹ /s Linear motor: mm/s ²	10000	All	After restart	Setup

Constant of Deceleration for Safety Function B

Parameter No.	Size	Setting Range	Setting Unit	Default Setting	Applicable Motors	When Enabled	Classification
Pn623 (2623h)	2	1 to 30000	Rotary motor: min ⁻¹ /s Linear motor: mm/s ²	10000	All	After restart	Setup

Motor Stop Detection Level for Active Mode

Parameter No.	Size	Setting Range	Setting Unit	Default Setting	Applicable Motors	When Enabled	Classification
Pn624 (2624h)	2	0 to 10000	Rotary motor: min ⁻¹ Linear motor: mm/s	10	All	After restart	Setup

Active Mode Hold Time

Parameter No.	Size	Setting Range	Setting Unit	Default Setting	Applicable Motors	When Enabled	Classification
Pn625 (2625h)	2	0 to 10000	10 ms	100	All	After restart	Setup

SERVOPACK Parameters (Pn) > Detailed Parameter Description of SERVOPACK Parameters (Pn)

Position Error Level for Releasing Active Mode

Parameter No.	Size	Setting Range	Setting Unit	Default Setting	Applicable Motors	When Enabled	Classification
Pn626 (2626h)	4	1 to 1073741823	1 reference unit	100	All	After restart	Setup

Speed Reference Level for Releasing Active Mode

Parameter No.	Size	Setting Range	Setting Unit	Default Setting	Applicable Motors	When Enabled	Classification
Pn628 (2628h)	2	0 to 10000	Rotary motor: min ⁻¹ Linear motor: mm/s	10	All	After restart	Setup

Application Switch 2 for Safety Function

Parameter No.	Size	Setting Range	Setting Unit	Default Setting	Applicable Motors	When Enabled	Classification
Pn629 (2629h)	2	0000h to 100Ah	–	0001h	All	–	Setup

n.□□XX	Safety Function Slot Selection for Monitoring		When Enabled	Reference
00	No Slot is selected.		Immediately	↔ 'Monitor Selection Method' ...page 166
01	Safety Function Slot 1 is selected for monitoring.			
02	Safety Function Slot 2 is selected for monitoring.			
03	Safety Function Slot 3 is selected for monitoring.			
04	Safety Function Slot 4 is selected for monitoring.			
05	Safety Function Slot 5 is selected for monitoring.			
06	Safety Function Slot 6 is selected for monitoring.			
07	Safety Function Slot 7 is selected for monitoring.			
08	Safety Function Slot 8 is selected for monitoring.			
09	Safety Function Slot 9 is selected for monitoring.			
0A	Safety Function Slot 10 is selected for monitoring.			

n.X□□□	Warning Detection Selection for Safety Module		When Enabled
0	A.9C□ will be detected when limit violation.		After restart
1	A.9C□ will not be detected even if limit violation.		

Application Switch 3 for Safety Function

Parameter No.	Size	Setting Range	Setting Unit	Default Setting	Applicable Motors	When Enabled	Classification
Pn62D (262Dh)	2	0000h to 0A0Ah	–	0000h	All	Immediately	Setup

n.□□XX	Selection of Active Mode A for Safety Function Slot		Reference
00	Active Mode A is disabled.		↪ 'Settings' ...page 186
01	Active Mode A works with Safety Function Slot 1.		
02	Active Mode A works with Safety Function Slot 2.		
03	Active Mode A works with Safety Function Slot 3.		
04	Active Mode A works with Safety Function Slot 4.		
05	Active Mode A works with Safety Function Slot 5.		
06	Active Mode A works with Safety Function Slot 6.		
07	Active Mode A works with Safety Function Slot 7.		
08	Active Mode A works with Safety Function Slot 8.		
09	Active Mode A works with Safety Function Slot 9.		
0A	Active Mode A works with Safety Function Slot 10.		

n.XX□□	Selection of Active Mode B for Safety Function Slot		Reference
00	Active Mode B is disabled.		↪ 'Settings' ...page 186
01	Active Mode B works with Safety Function Slot 1.		
02	Active Mode B works with Safety Function Slot 2.		
03	Active Mode B works with Safety Function Slot 3.		
04	Active Mode B works with Safety Function Slot 4.		
05	Active Mode B works with Safety Function Slot 5.		
06	Active Mode B works with Safety Function Slot 6.		
07	Active Mode B works with Safety Function Slot 7.		
08	Active Mode B works with Safety Function Slot 8.		
09	Active Mode B works with Safety Function Slot 9.		
0A	Active Mode B works with Safety Function Slot 10.		

A.2 Safe Parameters

Overview

This chapter describes the safety-related module parameters and the safety-related servo parameters (Pc).

A.2.1 General Device Parameters

General Device Parameters

Parameter No.	Index (hex)	Sub-index	Parameter Name	Direct Link
Pc070	5801h	0	FSoE Hardware Address	↪ 'FSoE Hardware Address'...page 218
Pc09E	580Eh	9	Limit Violation Deactivation Delay Time (LVDDT)	↪ 'Limit Violation Deactivation Delay Time (LVDDT)'...page 218
PcF37	–	–	Encoder Filter - Encoder Safety Usage	↪ 'Encoder Filter - Encoder Safety Usage'...page 218

A.2.1.1 Detailed Parameter Description of General Device Parameters

FSoE Hardware Address

Parameter No.	Index (hex)	Subindex	Data Type	Access	Setting Range	Setting Unit	Default Setting
Pc070	5801h	0	UINT	RO	0000h to FFFFh	–	0000h



This parameter must be written via the Yaskawa software "Advanced Safety Module Parameter Editor".
If the FSoE Address is set to 0000h the FSoE functionality is switched off.

Limit Violation Deactivation Delay Time (LVDDT)

Parameter No.	Index (hex)	Subindex	Data Type	Access	Setting Range	Setting Unit	Default Setting
Pc09E	580Eh	9	UINT	RO	0 to 10000	1 ms	0

The Limit Violation Deactivation Delay Time (LVDDT) is a global parameter. If a "Limit Violation" is detected in a safety function, the SERVOPACK is set to the safe state by the safety module in accordance with your parameterisation. If the Limit Violation is cleared, i.e. no longer present, the LVDDT time delays the time before the safety module leaves this safety function and thus the safe state. A constant state change of outputs is thus avoided.



This parameter must be written via the Yaskawa software "Advanced Safety Module Parameter Editor".

Encoder Filter - Encoder Safety Usage

Parameter No.	Index (hex)	Subindex	Data Type	Access	Setting Range	Setting Unit	Default Setting
PcF37	–	–	UINT	RO	0001h to 01FFh	Data samples ¹	0001h

1: This unit is applicable to the Encoder Filter only (Least Significant Byte).



This parameter must be written via the Yaskawa software "Advanced Safety Module Parameter Editor".

Digit	Name	Units R: Rotary L: Linear	Range	Default
0 - 7	Encoder Filter	–	1 - 255	1
8	External encoder safety usage	–	0 = External encoder is used for the safety function 1 = External encoder is not used for the safety function	0
9 - 15	reserved			

Encoder Filter

This byte defines the depth of the FIR Filter for the calculation of the internal acceleration value. If the SLA function is used, the setting of this parameter is mandatory.



If a value of 15 is used, the calculated value is very precise, but the calculation will take roughly 100 ms. Smaller values will increase the calculation time, but the calculated acceleration is less precise, which might cause the SLA function to detect a higher acceleration than the actual acceleration.

A.2.2 Motor and Encoder Parameters

Safety Related Servo Parameters

Parameter No.	Index (hex)	Sub-index	Parameter Name	Direct Link
Pc050	5800h	1	Motor Setting Switch	↪ 'Motor Setting Switch'...page 220
Pc051	5800h	2	Function Setting Switch	↪ 'Function Setting Switch'...page 221
Pc05A	5800h	3	External Encoder Setting Switch	↪ 'External Encoder Setting Switch'...page 221
Pc05C	5800h	4	Encoder Number of Pulses (External Encoder)	↪ 'Encoder Number of Pulses (External Encoder)'...page 222
Pc060	5800h	5	Encoder Data Format Configuration 1 (Motor Encoder)	↪ 'Encoder Data Format Configuration 1 (Motor Encoder)'...page 223
Pc062	5800h	6	Motor Max. Speed (Motor Encoder)	↪ 'Motor Max. Speed (Motor Encoder)'...page 224
Pc063	5800h	7	Linear Scale Pitch, Mantissa (Motor Encoder)	↪ 'Linear Scale Pitch, Mantissa (Motor Encoder)'...page 224
Pc065	5800h	8	Linear Scale Pitch, Exponent and Linear Encoder Resolution (Motor Encoder)	↪ 'Linear Scale Pitch, Exponent and Linear Encoder Resolution (Motor Encoder)'...page 225
Pc066	5800h	9	Encoder Number of Pulses (Motor Encoder)	↪ 'Encoder Number of Pulses (Motor Encoder)'...page 226
Pc068	5800h	10	Encoder Information (Motor Encoder)	↪ 'Encoder Information (Motor Encoder)'...page 226

Parameter No.	Index (hex)	Sub-index	Parameter Name	Direct Link
Pc069	5800h	11	Encoder Data Format Configuration 2 (Motor Encoder)	↔ 'Encoder Data Format Configuration 2 (Motor Encoder)'...page 227
Pc06A	5800h	12	Multiturn Limit	↔ 'Multiturn Limit'...page 227
Pc06B	5800h	13	Encoder Information (External Encoder)	↔ 'Encoder Information (External Encoder)'...page 228
Pc06C	5800h	14	Encoder Data Format Configuration 2 (External Encoder)	↔ 'Encoder Data Format Configuration 2 (External Encoder)'...page 229
Pc06D	5800h	15	Linear Scale Pitch, Mantissa (External Encoder)	↔ 'Linear Scale Pitch, Mantissa (External Encoder)'...page 229
Pc06F	5800h	16	Linear Scale Pitch, Exponent and Linear Encoder Resolution (External Encoder)	↔ 'Linear Scale Pitch, Exponent and Linear Encoder Resolution (External Encoder)'...page 230

A.2.2.1 Detailed Parameter Description of Motor and Encoder Parameters

Motor Setting Switch

Parameter No.	Index (hex)	Subindex	Data Type	Access	Setting Range	Setting Unit	Default Setting
Pc050	5800h	1	UINT	RO	0000h to 0011h	–	0000h

Digit	Name	Units R: Rotary L: Linear	Range	Default
0	Motor type setting	–	0 = Rotary motor 1 = Linear motor	0
1	Motor direction	–	0 = Normal 1 = Reverse	0
2	Reserved parameter (Do not change.)			
3	Reserved parameter (Do not change.)			



This parameter must be written via the Yaskawa software "Advanced Safety Module Parameter Editor".

The corresponding SERVOPACK parameter for Pc050.1 (Motor direction) is Pn000.0 (Direction Selection).

This parameter describes the type and direction of the motor set in the SERVOPACK. This setting influences the position calculation in the SERVOPACK and the position values sent to the safety module via the serial communication.

Motor Type	Motor Direction	Value	Movement Direction Selection
Rotary Motor	Normal	0 (0000h)	Pn000.0 = 0
	Reverse	16 (0010h)	Pn000.0 = 1
Linear Motor	Normal	1 (0001h)	Pn000.0 = 0
	Reverse	17 (0011h)	Pn000.0 = 1

Function Setting Switch

Parameter No.	Index (hex)	Subindex	Data Type	Access	Setting Range	Setting Unit	Default Setting
Pc051	5800h	2	UINT	RO	0000h to 0001h	–	0000h

Digit	Name	Units R: Rotary L: Linear	Range	Default
0	Selection of Test without motor	–	0 = disabled 1 = enabled	0
1	Reserved parameter (Do not change.)			
2	Reserved parameter (Do not change.)			
3	Reserved parameter (Do not change.)			



This parameter must be written via the Yaskawa software "Advanced Safety Module Parameter Editor".

The corresponding SERVOPACK parameter for Pc051.0 (Selection of Test without motor) is Pn00C.0 (Function Selection for Test without a Motor).

Test without motor is not possible with the safety module!

Value	Function Selection for Test without a Motor
0 (0000h)	Pn00C.0 = 0
1 (0001h) (Reserved. Do not use.)	Pn00C.0 = 1

External Encoder Setting Switch

Parameter No.	Index (hex)	Subindex	Data Type	Access	Setting Range	Setting Unit	Default Setting
Pc05A	5800h	3	UINT	RO	0000h to 0012h	–	0000h

Digit	Name	Units R: Rotary L: Linear	Range	Default
0	External encoder setting	–	0 = does not use external encoder 1 = uses external encoder 2 = uses external encoder for functional safety	0
1	External encoder direction	–	0 = equal direction to motor encoder 1 = reverse direction to motor encoder	0
2	Reserved parameter (Do not change.)			
3	Reserved parameter (Do not change.)			



This parameter must be written via the Yaskawa software "Advanced Safety Module Parameter Editor".

The corresponding SERVOPACK parameters are Pn002.3 (External Encoder Usage) and Pn00E.3 (External encoder monitor usage).

Motor Type	Value	External Encoder Monitor Selection	External Encoder Usage
Rotary Motor	0 (0000h)	Pn00E.3 = 0	Pn002.3 = 0
	1 (0001h)		Pn002.3 = 1
	17 (0011h)		Pn002.3 = 3
	2 (0002h)	Pn00E.3 = 1	Pn002.3 = 0
	18 (0012h)	Pn00E.3 = 3	
Linear Motor	0 (0000h)	Pn00E.3 = 0	-
	2 (0002h)	Pn00E.3 = 1	
	18 (0012h)	Pn00E.3 = 3	

Encoder Number of Pulses (External Encoder)

Parameter No.	Index (hex)	Subindex	Data Type	Access	Setting Range	Setting Unit	Default Setting
Pc05C	5800h	4	UDINT	RO	0 to 16777216	pulse/rev	16777216



This parameter must be written via the Yaskawa software "Advanced Safety Module Parameter Editor".

The corresponding SERVOPACK parameters are Pn002.3 (External Encoder Usage), Pn00E.0 (Resolution calculating method of an external encoder), Pn00E.3 (External encoder monitor usage) and Pn23E (Number of External Encoder Pulses).

This parameter depends on the connected external encoder.

Motor Type	Value	Resolution calculating method of an external encoder	External Encoder Monitor Selection	External Encoder Usage
Rotary Motor	0	Pn00E.0 = 0	Pn00E.3 = 0	Pn002.3 = 0
	0			Pn002.3 = 1
	0			Pn002.3 = 3
	0		Pn00E.3 = 1	Pn002.3 = 0
	0		Pn00E.3 = 3	
	0	Pn00E.0 = 1	Pn00E.3 = 0	Pn002.3 = 1
	= Pn23E			
	= Pn23E			Pn002.3 = 0
	= Pn23E			
	= Pn23E			
0	Pn00E.0 = 0	Pn00E.3 = 0	Pn002.3 = 1	
0				

Motor Type	Value	Resolution calculating method of an external encoder	External Encoder Monitor Selection	External Encoder Usage
				Pn002.3 = 3
			Pn00E.3 = 1	Pn002.3 = 0
			Pn00E.3 = 3	
		Pn00E.0 = 1	Pn00E.3 = 0	Pn002.3 = 1
				Pn002.3 = 3
			Pn00E.3 = 1	Pn002.3 = 0
		Pn00E.3 = 3		

Basic Application	External Encoder Type	Value	Number of External Encoder Pulses
Rotary Application	JZDP-Z001-000	131072	Pn23E = 131072
	JZDP-Z002-000	1048576	Pn23E = 1048576
	Resolver Absolute	16384	Pn23E = 16384
	Resolver Incremental		Pn23E = 16384
Linear Application	JZDP-H□□□-□□□	0	Pn23E = 0
	JZDP-J□□□-□□□		Pn23E = 0

Encoder Data Format Configuration 1 (Motor Encoder)

Parameter No.	Index (hex)	Subindex	Data Type	Access	Setting Range	Setting Unit	Default Setting
Pc060	5800h	5	UINT	RO	0 to 32	Bit	24



This parameter must be written via the Yaskawa software "Advanced Safety Module Parameter Editor".

This parameter depends on the connected servomotor.

Motor Type	Motor/Encoder Type, Serial Converter Type	Value
Rotary Motor	SGM7□-□□□□□	24
Linear Motor	JZDP-H□□□-□□□	8
	JZDP-J□□□-□□□	12

Motor Max. Speed (Motor Encoder)

Parameter No.	Index (hex)	Subindex	Data Type	Access	Setting Range	Setting Unit	Default Setting
Pc062	5800h	6	UINT	RO	0000h to FFFFh	–	003Ch

Digit	Name	Units R: Rotary L: Linear	Range	Default
0 - 1	Mantissa	R: 100 min ⁻¹ L: 100 mm/s	R: 0 to 25500 L: 100 to 1000	0106h
2 - 3	Exponent		03h: 10 ³ 02h: 10 ² 01h: 10 ¹ 00h: 10 ⁰ FFh: 10 ⁻¹ FEh: 10 ⁻² FDh: 10 ⁻³	00h



This parameter must be written via the Yaskawa software "Advanced Safety Module Parameter Editor".

Linear Motor: Max speed depends on Motor parameter (stored in serial converter) and SERVOPACK Pn385 (Maximum Motor Speed).

Example of a rotary motor:

SGM7A-□□□□□□ (6000 rpm)

Mantissa: 6

Exponent: 01h

262 (0106h) = 6*10⁰¹ [100 rpm]

Example of a linear motor:

SGLFW2-30D120A□□□□ (5.0 m/s)

Mantissa: 5

Exponent: 01h

261 (0105h) = 5*10⁰¹ [100 mm/s]

Linear Scale Pitch, Mantissa (Motor Encoder)

Parameter No.	Index (hex)	Subindex	Data Type	Access	Setting Range	Setting Unit	Default Setting
Pc063	5800h	7	UDINT	RO	0 to 16777216	fm	0



This parameter must be written via the Yaskawa software "Advanced Safety Module Parameter Editor".

The corresponding SERVOPACK parameter is Pn282 (Linear Encoder Pitch).

Motor Type	Motor Encoder (Manufacturer, Model)	Linear Scale Pitch (Motor Encoder)			External Encoder Scale Pitch
		Pc063 (Mantissa)	Pc065.0-1 (Exponent)	Value	
Rotary Motor	–	0 (00h)	0 (00h)	0	Pn282 = 0
Linear Motor	Heidenhain LIDA48*	2 (02h)	10 (0Ah)	$2 \cdot 10^{10}$	Pn282 = 2000
	Heidenhain LIF48*	4 (04h)	9 (09h)	$4 \cdot 10^9$	Pn282 = 400
	Renishaw PLC RGH22B	2 (02h)	10 (0Ah)	$2 \cdot 10^{10}$	Pn282 = 2000



$Linear\ Scale\ Pitch(fm) = Mantissa * 10^{Exponent}$

$Linear\ Scale\ Pitch(fm) = Pc063 * 10^{Pc065.0-1}$

Linear Scale Pitch, Exponent and Linear Encoder Resolution (Motor Encoder)

Parameter No.	Index (hex)	Subindex	Data Type	Access	Setting Range	Setting Unit	Default Setting
Pc065	5800h	8	UINT	RO	0000h to FFFFh	–	0000h

Digit	Name	Units R: Rotary L: Linear	Range	Default
0 - 1	Linear Scale Pitch, Exponent (Motor Encoder)	–	0 - 255	0
2 - 3	Linear Encoder Resolution (Motor Encoder)	Bit / Scale Pitch	00h to FFh	0

Linear Scale Pitch, Exponent (Motor Encoder), see description of Pc063.



Linear Scale Pitch, Exponent (Motor Encoder)

This parameter must be written via the Yaskawa software "Advanced Safety Module Parameter Editor".

The corresponding SERVOPACK parameter is Pn282 (Linear Encoder Pitch).

Linear Encoder Resolution (Motor Encoder)

Motor Type	Motor/Encoder Type, Serial Converter Type	Value
Rotary Motor	SGM7□-□□□□□	0
Linear Motor	JZDP-H□□□-□□□	8
	JZDP-J□□□-□□□	12

Encoder Number of Pulses (Motor Encoder)

Parameter No.	Index (hex)	Subindex	Data Type	Access	Setting Range	Setting Unit	Default Setting
Pc066	5800h	9	UDINT	RO	0 to 1073741824	pulse/rev	0



This parameter must be written via the Yaskawa software "Advanced Safety Module Parameter Editor".

This parameter depends on the connected servomotor.

Linear encoder resolution (Motor Encoder)

Motor Type	Motor/Encoder Type, Serial Converter Type	Value
Rotary Motor	SGM7J-□□□□□	16777216
	SGM7A-□□□□□	16777216
	SGM7G-□□□□□	16777216
Linear Motor	JZDP-H□□□-□□□	0
	JZDP-J□□□-□□□	0

Encoder Information (Motor Encoder)

Parameter No.	Index (hex)	Subindex	Data Type	Access	Setting Range	Setting Unit	Default Setting
Pc068	5800h	10	UINT	RO	0000h to 2111h	–	0000h

Digit	Name	Units R: Rotary L: Linear	Range	Default
0	Encoder hardware type	–	0 = Incremental 1 = Absolute	0
1	Reverse mode	–	0 = Normal 1 = Reverse	0
2	Encoder data format	–	0 = Linear 1 = Rotary	1
3	Motor Encoder usage		0 = Absolute (multi-turn) 1 = Incremental 2 = Absolute (single-turn)	



This parameter must be written via the Yaskawa software "Advanced Safety Module Parameter Editor".

- Encoder hardware type

This parameter depends on the connected servomotor.

- Reverse mode

This parameter depends on the connected servomotor. The value for all 400 V rotary servomotors and all the linear servomotors is "Normal". The value for a part of the 200 V direct drive servomotors (SGMCS) is "Reverse". This concerns the following motors: SGMCS-45M□□□□, SGMCS-80M□□□□, SGMCS-1AM□□□□, SGMCS-80N□□□□, SGMCS-1EN□□□□, SGMCS-2ZN□□□□.

- Encoder data format

This parameter depends on the connected servomotor.

- Motor Encoder usage

The corresponding SERVOPACK parameter for PC068.3 (Motor Encoder usage) is Pn002.2 (Absolute Encoder Usage).

Motor Type	Motor Encoder Setting	Value	Encoder Usage
Rotary Motor	Absolute (multi-turn)	257 (0101h)	Pn002.2 = 0
	Incremental	4353 (1101h)	Pn002.2 = 1
	Absolute (single-turn)	8449 (2101h)	Pn002.2 = 2
Linear Motor	Incremental	4096 (1000h)	Pn002.2 = 1

Encoder Data Format Configuration 2 (Motor Encoder)

Parameter No.	Index (hex)	Subindex	Data Type	Access	Setting Range	Setting Unit	Default Setting
Pc069	5800h	11	UINT	RO	0000h to FFFFh	–	0000h



This parameter must be written via the Yaskawa software "Advanced Safety Module Parameter Editor".

This parameter depends on the connected servomotor.

Motor Type	Motor/Encoder Type, Serial Converter Type	Value
Rotary Motor	SGM7□-□□□□□	20536
Linear Motor	JZDP-H□□□-□□□	20540
	JZDP-J□□□-□□□	20540

Multiturn Limit

Parameter No.	Index (hex)	Subindex	Data Type	Access	Setting Range	Setting Unit	Default Setting
Pc06A	5800h	12	UINT	RO	0 to 65535	rev	65535



This parameter must be written via the Yaskawa software "Advanced Safety Module Parameter Editor".

The corresponding SERVOPACK parameter for PC06A (Multiturn Limit) is Pn205 (Multiturn Limit).

Motor Type	Motor/Encoder Type, Serial Converter Type	Value	Multiturn Limit
Rotary Motor	SGM7J-□□□7□	= Pn205	Pn205 = 0
	SGM7A-□□□7□	= Pn205	to
	SGM7G-□□□7□	= Pn205	Pn205 = 65535
	SGM7J-□□□F□	= Pn205	Pn205 = 0
	SGM7A-□□□F□	= Pn205	Pn205 = 0
	SGM7G-□□□F□	= Pn205	Pn205 = 0
Linear Motor	JZDP-H□□□-□□□	= Pn205	Pn205 = 0
	JZDP-J□□□-□□□	= Pn205	

Encoder Information (External Encoder)

Parameter No.	Index (hex)	Subindex	Data Type	Access	Setting Range	Setting Unit	Default Setting
Pc06B	5800h	13	UINT	RO	0000h to 1111h	–	0000h

Digit	Name	Units R: Rotary L: Linear	Range	Default
0	Encoder type	–	0 = Incremental 1 = Absolute	0
1	Reverse mode	–	0 = Normal 1 = Reverse	0
2	Encoder data format	–	0 = Linear 1 = Rotary	0
3	Resolution calculation method	–	0 = Scale pitch (Pc06D and Pc06F) 1 = Number of pulses (Pc05C)	0



This parameter must be written via the Yaskawa software "Advanced Safety Module Parameter Editor".

- Encoder type
This parameter depends on the connected external encoder.
- Reverse mode
This parameter depends on the connected external encoder.
- Encoder data format
This parameter depends on the connected external encoder.
- Resolution calculation method
The corresponding SERVOPACK parameter for PC06B.3 (Resolution calculation method) is Pn00E.0 (Resolution calculating method of an external encoder).

Basic Application	Motor/Encoder Type, Serial Converter Type	Value	Resolution calculating method of an external encoder
Rotary Application	None	0	
	JZDP-Z001-0000	4096 (1000h)	Pn00E.0 = 1
	JZDP-Z002-0000	4097 (1001h)	
	Resolver Absolute	4097 (1001h)	
	Resolver Incremental	4096 (1000h)	
Linear Application	None	0 (0000h)	
	JZDP-H□□□-□□□	0 (0000h)	Pn00E.0 = 0
	JZDP-J□□□-□□□	0 (0000h)	

Encoder Data Format Configuration 2 (External Encoder)

Parameter No.	Index (hex)	Subindex	Data Type	Access	Setting Range	Setting Unit	Default Setting
Pc06C	5800h	14	UINT	RO	0000h to FFFFh	–	0000h



This parameter must be written via the Yaskawa software "Advanced Safety Module Parameter Editor".

This parameter depends on the connected external encoder.

Feedback Option Type	Value
SGDV-OFA01A	20540
SGDV-OFB04A	20546

Linear Scale Pitch, Mantissa (External Encoder)

Parameter No.	Index (hex)	Subindex	Data Type	Access	Setting Range	Setting Unit	Default Setting
Pc06D	5800h	15	UDINT	RO	0 to 16777216	fm	0



This parameter must be written via the Yaskawa software "Advanced Safety Module Parameter Editor".

The corresponding SERVOPACK parameters for Pc06D (Linear Scale Pitch, Mantissa (External Encoder)) are Pn00E.0 (Resolution calculating method of an external encoder), Pn00E.3 (External encoder monitor usage) and Pn246 (External encoder Scale pitch).

Basic Application	Encoder Number of Pulses (External Encoder)			External Encoder Monitor Selection	Resolution calculating method of an external encoder
	Pc06D	Pc06F.0-1	Value		
Rotary Application	0	0	0	Pn00E.3 = 0	Pn00E.0 = 0

Basic Application	Encoder Number of Pulses (External Encoder)			External Encoder Monitor Selection	Resolution calculating method of an external encoder
	Pc06D	Pc06F.0-1	Value		
Linear Application	0	0	0		Pn00E.0 = 1
	Mantissa	Exponent	= Pn246	Pn00E.3 = 1	Pn00E.0 = 0
	0	0	0		Pn00E.0 = 1
	Mantissa	Exponent	= Pn246	Pn00E.3 = 3	Pn00E.0 = 0
	0	0	0		Pn00E.0 = 1

Basic Application	Motor Encoder (Manufacturer, Model)	Linear Scale Pitch (External Encoder)			External Encoder Scale Pitch
		Pc06D (Mantissa)	Pc06F.0-1 (Exponent)	Value	
Rotary Application	–	0 (00h)	0 (00h)	0	Pn246 = 0
Linear Application	Heidenhain LIDA48*	2 (02h)	10 (0Ah)	2*10 ¹⁰	Pn246 = 2000
	Heidenhain LIF48*	4 (04h)	9 (09h)	4*10 ⁹	Pn246 = 400
	Renishaw PLC RGH22B	2 (02h)	10 (0Ah)	2*10 ¹⁰	Pn246 = 2000



$Linear\ Scale\ Pitch(fm) = Mantissa * 10^{Exponent}$
 $Linear\ Scale\ Pitch(fm) = Pc06D * 10^{Pc06F.0-1}$

Linear Scale Pitch, Exponent and Linear Encoder Resolution (External Encoder)

Parameter No.	Index (hex)	Subindex	Data Type	Access	Setting Range	Setting Unit	Default Setting
Pc06F	5800h	16	UINT	RO	0000h to FFFFh	–	0000h

Digit	Name	Units R: Rotary L: Linear	Range	Default
0 - 1	Linear Scale Pitch, Exponent (External Encoder)	–	0 - 255	0
2 - 3	Linear Encoder Resolution (External Encoder)	Bit / Scale Pitch	00h to FFh	0

Linear Scale Pitch, Exponent (External Encoder), see description of Pc06D.



Linear Scale Pitch, Exponent (External Encoder)

This parameter must be written via the Yaskawa software "Advanced Safety Module Parameter Editor".

The corresponding SERVOPACK parameters for Pc06F (Linear Scale Pitch, Exponent & Linear Encoder Resolution (External Encoder)) are Pn00E.0 (Resolution calculating method of an external encoder), Pn00E.3 (External encoder monitor usage) and Pn246 (External encoder Scale pitch).

Linear Encoder Resolution (External Encoder)

Motor Type	Serial Converter Type	Value
Linear Motor	JZDP-H□□□-□□□	8
	JZDP-J□□□-□□□	12

A.2.3 User Unit and Encoder Parameters

User Unit and Encoder Parameters

Parameter No.	Index (hex)	Sub-index	Parameter Name	Direct Link
Pc072	5802h	0	Numerator Position User Units Encoder 1	↗ 'Numerator Position User Units Encoder 1'...page 232
Pc074	5803h	0	Denominator Position User Units Encoder 1	↗ 'Denominator Position User Units Encoder 1'...page 232
Pc07A	5806h	0	Numerator Velocity User Units Encoder 1	↗ 'Numerator Velocity User Units Encoder 1'...page 233
Pc07C	5807h	0	Denominator Velocity User Units Encoder 1	↗ 'Denominator Velocity User Units Encoder 1'...page 233
Pc082	580Ah	0	Numerator Acceleration User Units Encoder 1	↗ 'Numerator Acceleration User Units Encoder 1'...page 234
Pc084	580Bh	0	Denominator Acceleration User Units Encoder 1	↗ 'Denominator Acceleration User Units Encoder 1'...page 234
Pc076	5804h	0	Numerator Position User Units Encoder 2	↗ 'Numerator Position User Units Encoder 2'...page 232
Pc078	5805h	0	Denominator Position User Units Encoder 2	↗ 'Denominator Position User Units Encoder 2'...page 233
Pc07E	5808h	0	Numerator Velocity User Units Encoder 2	↗ 'Numerator Velocity User Units Encoder 2'...page 233
Pc080	5809h	0	Denominator Velocity User Units Encoder 2	↗ 'Denominator Velocity User Units Encoder 2'...page 234
Pc086	580Ch	0	Numerator Acceleration User Units Encoder 2	↗ 'Numerator Acceleration User Units Encoder 2'...page 234
Pc088	580Dh	0	Denominator Acceleration User Units Encoder 2	↗ 'Denominator Acceleration User Units Encoder 2'...page 235
Pc08A - Pc08D	580Eh	1	User Units (Position)	↗ 'User Units (Position), character (1, 2 - 3, 4 - 5, 6 - 7, 8)'...page 235
Pc08E - Pc091	580Eh	2	User Units (Velocity)	↗ 'User Units (Velocity), character (1, 2 - 3, 4 - 5, 6 - 7, 8)'...page 236

Safe Parameters > User Unit and Encoder Parameters

Parameter No.	Index (hex)	Sub-index	Parameter Name	Direct Link
Pc092 - Pc095	580Eh	3	User Units (Acceleration)	↪ 'User Units (Acceleration), character (1, 2 - 3, 4 - 5, 6 - 7, 8)'...page 236
Pc097	580Eh	5	Encoder Deviation	↪ 'Encoder Deviation'...page 237
Pc099	580Eh	6	Encoder Deviation Window	↪ 'Encoder Deviation Window'...page 237

A.2.3.1 Detailed Parameter Description of User Unit and Encoder Parameters

Numerator Position User Units Encoder 1

Parameter No.	Index (hex)	Subindex	Data Type	Access	Setting Range	Default Setting
Pc072	5802h	0	UDINT	RO	1 to 1073741824	1



This parameter must be written via the Yaskawa software "Advanced Safety Module Parameter Editor".

Denominator Position User Units Encoder 1

Parameter No.	Index (hex)	Subindex	Data Type	Access	Setting Range	Default Setting
Pc074	5803h	0	UDINT	RO	1 to 1073741824	1



This parameter must be written via the Yaskawa software "Advanced Safety Module Parameter Editor".

Numerator Position User Units Encoder 2

Parameter No.	Index (hex)	Subindex	Data Type	Access	Setting Range	Default Setting
Pc076	5804h	0	UDINT	RO	1 to 1073741824	1



This parameter must be written via the Yaskawa software "Advanced Safety Module Parameter Editor".

Denominator Position User Units Encoder 2

Parameter No.	Index (hex)	Subindex	Data Type	Access	Setting Range	Default Setting
Pc078	5805h	0	UDINT	RO	1 to 1073741824	1



This parameter must be written via the Yaskawa software "Advanced Safety Module Parameter Editor".

Numerator Velocity User Units Encoder 1

Parameter No.	Index (hex)	Subindex	Data Type	Access	Setting Range	Default Setting
Pc07A	5806h	0	UDINT	RO	1 to 1073741824	1



This parameter must be written via the Yaskawa software "Advanced Safety Module Parameter Editor".

Denominator Velocity User Units Encoder 1

Parameter No.	Index (hex)	Subindex	Data Type	Access	Setting Range	Default Setting
Pc07C	5807h	0	UDINT	RO	1 to 1073741824	1



This parameter must be written via the Yaskawa software "Advanced Safety Module Parameter Editor".

Numerator Velocity User Units Encoder 2

Parameter No.	Index (hex)	Subindex	Data Type	Access	Setting Range	Default Setting
Pc07E	5808h	0	UDINT	RO	1 to 1073741824	1



This parameter must be written via the Yaskawa software "Advanced Safety Module Parameter Editor".

Safe Parameters > User Unit and Encoder Parameters

Denominator Velocity User Units Encoder 2

Parameter No.	Index (hex)	Subindex	Data Type	Access	Setting Range	Default Setting
Pc080	5809h	0	UDINT	RO	1 to 1073741824	1



This parameter must be written via the Yaskawa software "Advanced Safety Module Parameter Editor".

Numerator Acceleration User Units Encoder 1

Parameter No.	Index (hex)	Subindex	Data Type	Access	Setting Range	Default Setting
Pc082	580Ah	0	UDINT	RO	1 to 1073741824	1



This parameter must be written via the Yaskawa software "Advanced Safety Module Parameter Editor".

Denominator Acceleration User Units Encoder 1

Parameter No.	Index (hex)	Subindex	Data Type	Access	Setting Range	Default Setting
Pc084	580Bh	0	UDINT	RO	1 to 1073741824	10000



This parameter must be written via the Yaskawa software "Advanced Safety Module Parameter Editor".

Numerator Acceleration User Units Encoder 2

Parameter No.	Index (hex)	Subindex	Data Type	Access	Setting Range	Default Setting
Pc086	580Ch	0	UDINT	RO	1 to 1073741824	1



This parameter must be written via the Yaskawa software "Advanced Safety Module Parameter Editor".

Denominator Acceleration User Units Encoder 2

Parameter No.	Index (hex)	Subindex	Data Type	Access	Setting Range	Default Setting
Pc088	580Dh	0	UDINT	RO	1 to 1073741824	10000



This parameter must be written via the Yaskawa software "Advanced Safety Module Parameter Editor".

User Units (Position), character (1, 2 - 3, 4 - 5, 6 - 7, 8)

Parameter No.	Index (hex)	Subindex	Data Type	Access	Setting Range	Setting Unit	Default Setting
Pc08A to Pc08D	580Eh	1	STRING(8)	RO	See table below	–	0000h

Digit	Name	Units R: Rotary L: Linear	Range	Default
0-1	Character 1	–	00h, 20h to 7Eh	00h
2-3	Character 2	–	00h, 20h to 7Eh	00h
4-5	Character 3	–	00h, 20h to 7Eh	00h
6-7	Character 4	–	00h, 20h to 7Eh	00h
8-9	Character 5	–	00h, 20h to 7Eh	00h
10-11	Character 6	–	00h, 20h to 7Eh	00h
12-13	Character 7	–	00h, 20h to 7Eh	00h
14-15	Character 8	–	00h, 20h to 7Eh	00h



This parameter must be written via the Yaskawa software "Advanced Safety Module Parameter Editor".

The upper and lower limits and the default values will not be checked in the firmware. These limits apply to the PC Software only.

Safe Parameters > User Unit and Encoder Parameters

User Units (Velocity), character (1, 2 - 3, 4 - 5, 6 - 7, 8)

Parameter No.	Index (hex)	Subindex	Data Type	Access	Setting Range	Setting Unit	Default Setting
Pc08E to Pc091	580Eh	2	STRING(8)	RO	See table below	–	0000h

Digit	Name	Units R: Rotary L: Linear	Range	Default
0-1	Character 1	–	00h, 20h to 7Eh	00h
2-3	Character 2	–	00h, 20h to 7Eh	00h
4-5	Character 3	–	00h, 20h to 7Eh	00h
6-7	Character 4	–	00h, 20h to 7Eh	00h
8-9	Character 5	–	00h, 20h to 7Eh	00h
10-11	Character 6	–	00h, 20h to 7Eh	00h
12-13	Character 7	–	00h, 20h to 7Eh	00h
14-15	Character 8	–	00h, 20h to 7Eh	00h



This parameter must be written via the Yaskawa software "Advanced Safety Module Parameter Editor".

The upper and lower limits and the default values will not be checked in the firmware. These limits apply to the PC Software only.

User Units (Acceleration), character (1, 2 - 3, 4 - 5, 6 - 7, 8)

Parameter No.	Index (hex)	Subindex	Data Type	Access	Setting Range	Setting Unit	Default Setting
Pc092 to Pc095	580Eh	3	STRING(8)	RO	See table below	–	0000h

Digit	Name	Units R: Rotary L: Linear	Range	Default
0-1	Character 1	–	00h, 20h to 7Eh	00h
2-3	Character 2	–	00h, 20h to 7Eh	00h
4-5	Character 3	–	00h, 20h to 7Eh	00h
6-7	Character 4	–	00h, 20h to 7Eh	00h
8-9	Character 5	–	00h, 20h to 7Eh	00h
10-11	Character 6	–	00h, 20h to 7Eh	00h
12-13	Character 7	–	00h, 20h to 7Eh	00h
14-15	Character 8	–	00h, 20h to 7Eh	00h



This parameter must be written via the Yaskawa software "Advanced Safety Module Parameter Editor".

The upper and lower limits and the default values will not be checked in the firmware. These limits apply to the PC Software only.

Encoder Deviation

Parameter No.	Index (hex)	Subindex	Data Type	Access	Setting Range	Setting Unit	Default Setting
Pc097	580Eh	5	UDINT	RO	0 to 4294967296	User Units	0



This parameter must be written via the Yaskawa software "Advanced Safety Module Parameter Editor".

Encoder Deviation Window

Parameter No.	Index (hex)	Subindex	Data Type	Access	Setting Range	Setting Unit	Default Setting
Pc099	580Eh	6	UDINT	RO	0 to 65535	ms	0



This parameter must be written via the Yaskawa software "Advanced Safety Module Parameter Editor".

A.2.4 I/O Configuration Parameters

I/O Parameters

Parameter No.	Index (hex)	Sub-index	Parameter Name	Direct Link
Pc0C0	5810h	1	Safe Port A - Configuration	↪ 'Safe Port A to G - Configuration'...page 238
Pc0C1	5810h	2	Safe Port A - Filter Time	↪ 'Safe Port A to F - Filter Time'...page 239
Pc0C2	5810h	3	Safe Port A - Discrepancy Time	↪ 'Safe Port A to F - Discrepancy Time'...page 240
Pc0C3	5810h	4	Safe Port A - Test Pulse Length	↪ 'Safe Port A to D - Test Pulse Length'...page 240
Pc0C8	5820h	1	Safe Port B - Configuration	↪ 'Safe Port A to G - Configuration'...page 238
Pc0C9	5820h	2	Safe Port B - Filter Time	↪ 'Safe Port A to F - Filter Time'...page 239
Pc0CA	5820h	3	Safe Port B - Discrepancy Time	↪ 'Safe Port A to F - Discrepancy Time'...page 240
Pc0CB	5820h	4	Safe Port B - Test Pulse Length	↪ 'Safe Port A to D - Test Pulse Length'...page 240
Pc0D0	5830h	1	Safe Port C - Configuration	↪ 'Safe Port A to G - Configuration'...page 238
Pc0D1	5830h	2	Safe Port C - Filter Time	↪ 'Safe Port A to F - Filter Time'...page 239

Safe Parameters > I/O Configuration Parameters

Parameter No.	Index (hex)	Sub-index	Parameter Name	Direct Link
Pc0D2	5830h	3	Safe Port C - Discrepancy Time	↗ ' Safe Port A to F - Discrepancy Time'...page 240
Pc0D3	5830h	4	Safe Port C - Test Pulse Length	↗ ' Safe Port A to D - Test Pulse Length'...page 240
Pc0D8	5840h	1	Safe Port D - Configuration	↗ 'Safe Port A to G - Configuration'...page 238
Pc0D9	5840h	2	Safe Port D - Filter Time	↗ ' Safe Port A to F - Filter Time'...page 239
Pc0DA	5840h	3	Safe Port D - Discrepancy Time	↗ ' Safe Port A to F - Discrepancy Time'...page 240
Pc0DB	5840h	4	Safe Port D - Test Pulse Length	↗ ' Safe Port A to D - Test Pulse Length'...page 240
Pc0E0	5850h	1	Safe Port E - Configuration	↗ 'Safe Port A to G - Configuration'...page 238
Pc0E1	5850h	2	Safe Port E - Filter Time	↗ ' Safe Port A to F - Filter Time'...page 239
Pc0E2	5850h	3	Safe Port E - Discrepancy Time	↗ ' Safe Port A to F - Discrepancy Time'...page 240
Pc0E8	5860h	1	Safe Port F - Configuration	↗ 'Safe Port A to G - Configuration'...page 238
Pc0E9	5860h	2	Safe Port F - Filter Time	↗ ' Safe Port A to F - Filter Time'...page 239
Pc0EA	5860h	3	Safe Port F - Discrepancy Time	↗ ' Safe Port A to F - Discrepancy Time'...page 240
Pc0EC	5860h	4	Safe Port F - Channel Tolerance	↗ ' Safe Port F - Channel Tolerance'...page 241
Pc0F0	5870h	1	Port G - Configuration	↗ 'Safe Port A to G - Configuration'...page 238

A.2.4.1 Detailed Parameter Description of I/O Configuration Parameters

Safe Port A to G - Configuration

Parameter No.	Port	Index (hex)	Subindex	Data Type	Access	Setting Range	Default Setting
Pc0C0	A	5810h	1	UINT	RO	0000h to 000Bh	0000h
Pc0C8	B	5820h	1	UINT	RO	0000h to 000Bh	0000h
Pc0D0	C	5830h	1	UINT	RO	0000h to 000Bh	0000h
Pc0D8	D	5840h	1	UINT	RO	0000h to 000Bh	0000h
Pc0E0	E	5850h	1	UINT	RO	0000h to 000Bh	0000h
Pc0E8	F	5860h	1	UINT	RO	0000h to 000Bh	0000h
Pc0F0	G	5870h	1	UINT	RO	0000h to 000Bh	0000h

Digit	Name	Units R: Rotary L: Linear	Range	Default
0 - 1	Safe Port Function → <i>'Detailed Parameter Description of I/O Configuration Parameters'...page 238</i>	–	0000h to 0009h	0000h
	00: None 01: Digital Input 02: Digital Input Test Pulse A 03: Digital Input Test Pulse B 04: Analog Input (0-10V) 05: reserved 06: Analog Input (4-20mA and PT1000) 07: Digital Output 08: Digital Output EDM 09: Digital Output Test Pulse 0A: reserved 0B: reserved			
2 to 3	reserved			



This parameter must be written via the Yaskawa software "Advanced Safety Module Parameter Editor".

Not needed in SGD7S-OSB01: 0

I/O Port Function Types

Safe	Function Type	A	B	C	D	E	F	G1	G2
2-channel	Digital Input	●	●	●	●	●	●	–	–
2-channel	Digital Input Test Pulse A	–	●	●	●	●	●	–	–
2-channel	Digital Input Test Pulse B	●	–	●	●	●	●	–	–
2-channel	Analog Input (0-10V)	–	–	–	–	–	●	–	–
1-channel	Analog Input (4-20mA)	–	–	–	–	–	–	●	–
1-channel	Analog Input (PT1000)	–	–	–	–	–	–	–	●
2-channel	Digital Output	●	●	●	●	–	–	–	–
no	Digital Output EDM	●	●	●	●	–	–	–	–
2-channel	Digital Output Test Pulse	●	●	–	–	–	–	–	–

● = Available

– = Not available

Safe Port A to F - Filter Time

Parameter No.	Port	Index (hex)	Subindex	Data Type	Access	Setting Range	Setting Unit	Default Setting
Pc0C1	A	5810h	2	UINT	RO	0 to 4000	250 μs	0
Pc0C9	B	5820h	2	UINT	RO	0 to 4000	250 μs	0
Pc0D1	C	5830h	2	UINT	RO	0 to 4000	250 μs	0
Pc0D9	D	5840h	2	UINT	RO	0 to 4000	250 μs	0
Pc0E1	E	5850h	2	UINT	RO	0 to 4000	250 μs	0
Pc0E9	F	5860h	2	UINT	RO	0 to 4000	250 μs	0



This parameter must be written via the Yaskawa software "Advanced Safety Module Parameter Editor".

Safe Port A to F - Discrepancy Time

Parameter No.	Port	Index (hex)	Subindex	Data Type	Access	Setting Range	Setting Unit	Default Setting
Pc0C2	A	5810h	3	UINT	RO	10 to 1000	1 ms	0
Pc0CA	B	5820h	3	UINT	RO	10 to 1000	1 ms	0
Pc0D2	C	5830h	3	UINT	RO	10 to 1000	1 ms	0
Pc0DA	D	5840h	3	UINT	RO	10 to 1000	1 ms	0
Pc0E2	E	5850h	3	UINT	RO	10 to 1000	1 ms	0
Pc0EA	F	5860h	3	UINT	RO	10 to 1000	1 ms	0



This parameter must be written via the Yaskawa software "Advanced Safety Module Parameter Editor".

Safe Port A to D - Test Pulse Length

Parameter No.	Port	Index (hex)	Subindex	Data Type	Access	Setting Range	Setting Unit	Default Setting
Pc0C3	A	5810h	4	UINT	RO	20 to 10000	0.1 ms	0
Pc0CB	B	5820h	4	UINT	RO	20 to 10000	0.1 ms	0
Pc0D3	C	5830h	4	UINT	RO	20 to 1000	0.1 ms	0
Pc0DB	D	5840h	4	UINT	RO	20 to 1000	0.1 ms	0



This parameter must be written via the Yaskawa software "Advanced Safety Module Parameter Editor".

The test pulse length parameterised at the output (e.g. monitoring for line break) must be shorter than the filter time parameterised at the corresponding input (at which the test pulse returns). If this is not the case, the signal received at the input is not interpreted as a test pulse but as a signal which triggers the safety function parameterised there.

Test pulses (port configured as Digital Output Test Pulse A or B) are used for **passive** switch relays that cannot generate and evaluate their own test pulses. These test pulses must therefore also be routed back to the safety module (port configured as Digital Input Test Pulse A or B).

At the digital output port of the pulse, the length of the test pulse is defined. At the digital input port the filter time (filters out the test pulses and prevents them from leading to an activation of the parameterised safety function) and the discrepancy time (time difference between dual input channels when one of them has its state changed) are defined.

Active components with integrated evaluation electronics, such as a light curtain that detects the penetration of a body part into a protective field with the aid of sensors, include OSSD output switching elements (Output Signal Switching Device) as safe switching outputs that switch to the OFF state when the control or monitoring function responds. OSSD output switching elements have a defined behavior under fault conditions and check the function of their outputs as a 'source' with test pulses. A connected 'sink' (controller or relay) should not react to these test pulses.

For this reason, the filter time must also be defined for the ports configured as inputs in the safety module so that the parameterised safety function cannot be unintentionally activated.

Safe Port F - Channel Tolerance

Parameter No.	Port	Index (hex)	Subindex	Data Type	Access	Setting Range	Setting Unit	Default Setting
Pc0EC	F	5860h	4	UINT	RO	0 to 1000	0.1%	10



This parameter must be written via the Yaskawa software "Advanced Safety Module Parameter Editor".

Parameter Dependencies

I/O Port Parameter Dependencies

Port Function	Filter Time	Discrepancy Time	Test Pulse Length	Channel Tolerance
00: None	–	–	–	–
01: Digital Input	●	●	–	–
02: Digital Input Test Pulse A	●	●	–	–
03: Digital Input Test Pulse B	●	●	–	–
04: Analog Input (0-10V)	–	–	–	●
06: Analog Input (4-20mA and PT1000)	–	–	–	–
07: Digital Output	–	–	●	–
08: Digital Output EDM	–	–	–	–
09: Digital Output Test Pulse	–	–	●	–

A.2.5 Slot Parameters

Slot 1 Parameters

Parameter No.	Index (hex)	Sub-index	Parameter Name	Direct Link
Pc300	5910h	1	Slot 1 - Configuration I	↪ 'Slot 1 to 10 - Configuration I'...page 249
Pc301	5910h	2	Slot 1 - Configuration II	↪ 'Slot 1 to 10 - Configuration II'...page 250
Pc310	5910h	3	Slot 1 - Waiting Time (t1)	↪ 'Slot 1 to 10 - Waiting Time (t1)'...page 251

Safe Parameters > Slot Parameters

Parameter No.	Index (hex)	Sub-index	Parameter Name	Direct Link
Pc311	5910h	4	Slot 1 - Monitoring Time (t2)	↗ 'Slot 1 to 10 - Monitoring Time (t2)'...page 252
Pc312	5910h	5	Slot 1 - Speed Limit (s1)	↗ 'Slot 1 to 10 - Speed Limit (s1)'...page 252
Pc314	5910h	6	Slot 1 - Speed Limit (s2)	↗ 'Slot 1 to 10 - Speed Limit (s2)'...page 253
Pc316	5910h	7	Slot 1 - Acceleration Limit (a1)	↗ 'Slot 1 to 10 - Acceleration Limit (a1)'...page 253
Pc318	5910h	8	Slot 1 - Distance Limit (p1)	↗ 'Slot 1 to 10 - Distance Limit (p1)'...page 254
Pc31A	5910h	9	Slot 1 - Distance Limit (p2)	↗ 'Slot 1 to 10 - Distance Limit (p2)'...page 254
Pc31C	5910h	10	Slot 1 - Distance Limit (p3)	↗ 'Slot 1 to 10 - Distance Limit (p3)'...page 255
Pc31E	5910h	11	Slot 1 - Torque Limit (tq1)	↗ 'Slot 1 to 10 - Torque Limit (tq1)'...page 256
Pc31F	5910h	12	Slot 1 - Temperature Limit (tp1)	↗ 'Slot 1 to 10 - Temperature Limit (tp1)'...page 256
Pc320	5910h	13	Slot 1 - Temperature Limit (tp2)	↗ 'Slot 1 to 10 - Temperature Limit (tp2)'...page 257
Pc09A	580Eh	7	Encoder Absolute Position Difference E1 to E2	↗ 'Encoder Absolute Position Difference E1 to E2'...page 257
Pc09C	580Eh	8	Encoder Offset E1 to Homing Position (Origin)	↗ 'Encoder Offset E1 to Homing Position (Origin)'...page 258

Slot 2 Parameters

Parameter No.	Index (hex)	Sub-index	Parameter Name	Direct Link
Pc380	5920h	1	Slot 2 - Configuration I	↗ 'Slot 1 to 10 - Configuration I'...page 249
Pc381	5920h	2	Slot 2 - Configuration II	↗ 'Slot 1 to 10 - Configuration II'...page 250
Pc390	5920h	3	Slot 2 - Waiting Time (t1)	↗ 'Slot 1 to 10 - Waiting Time (t1)'...page 251
Pc391	5920h	4	Slot 2 - Monitoring Time (t2)	↗ 'Slot 1 to 10 - Monitoring Time (t2)'...page 252
Pc392	5920h	5	Slot 2 - Speed Limit (s1)	↗ 'Slot 1 to 10 - Speed Limit (s1)'...page 252
Pc394	5920h	6	Slot 2 - Speed Limit (s2)	↗ 'Slot 1 to 10 - Speed Limit (s2)'...page 253
Pc396	5920h	7	Slot 2 - Acceleration Limit (a1)	↗ 'Slot 1 to 10 - Acceleration Limit (a1)'...page 253
Pc398	5920h	8	Slot 2 - Distance Limit (p1)	↗ 'Slot 1 to 10 - Distance Limit (p1)'...page 254
Pc39A	5920h	9	Slot 2 - Distance Limit (p2)	↗ 'Slot 1 to 10 - Distance Limit (p2)'...page 254

Parameter No.	Index (hex)	Sub-index	Parameter Name	Direct Link
Pc39C	5920h	10	Slot 2 - Distance Limit (p3)	↪ 'Slot 1 to 10 - Distance Limit (p3)'...page 255
Pc39E	5920h	11	Slot 2 - Torque Limit (tq1)	↪ 'Slot 1 to 10 - Torque Limit (tq1)'...page 256
Pc39F	5920h	12	Slot 2 - Temperature Limit (tp1)	↪ 'Slot 1 to 10 - Temperature Limit (tp1)'...page 256
Pc3A0	5920h	13	Slot 2 - Temperature Limit (tp2)	↪ 'Slot 1 to 10 - Temperature Limit (tp2)'...page 257
Pc09A	580Eh	7	Encoder Absolute Position Difference E1 to E2	↪ 'Encoder Absolute Position Difference E1 to E2'...page 257
Pc09C	580Eh	8	Encoder Offset E1 to Homing Position (Origin)	↪ 'Encoder Offset E1 to Homing Position (Origin)'...page 258

Slot 3 Parameters

Parameter No.	Index (hex)	Sub-index	Parameter Name	Direct Link
Pc400	5930h	1	Slot 3 - Configuration I	↪ 'Slot 1 to 10 - Configuration I'...page 249
Pc401	5930h	2	Slot 3 - Configuration II	↪ 'Slot 1 to 10 - Configuration II'...page 250
Pc410	5930h	3	Slot 3 - Waiting Time (t1)	↪ 'Slot 1 to 10 - Waiting Time (t1)'...page 251
Pc411	5930h	4	Slot 3 - Monitoring Time (t2)	↪ 'Slot 1 to 10 - Monitoring Time (t2)'...page 252
Pc412	5930h	5	Slot 3 - Speed Limit (s1)	↪ 'Slot 1 to 10 - Speed Limit (s1)'...page 252
Pc414	5930h	6	Slot 3 - Speed Limit (s2)	↪ 'Slot 1 to 10 - Speed Limit (s2)'...page 253
Pc416	5930h	7	Slot 3 - Acceleration Limit (a1)	↪ 'Slot 1 to 10 - Acceleration Limit (a1)'...page 253
Pc418	5930h	8	Slot 3 - Distance Limit (p1)	↪ 'Slot 1 to 10 - Distance Limit (p1)'...page 254
Pc41A	5930h	9	Slot 3 - Distance Limit (p2)	↪ 'Slot 1 to 10 - Distance Limit (p2)'...page 254
Pc41C	5930h	10	Slot 3 - Distance Limit (p3)	↪ 'Slot 1 to 10 - Distance Limit (p3)'...page 255
Pc41E	5930h	11	Slot 3 - Torque Limit (tq1)	↪ 'Slot 1 to 10 - Torque Limit (tq1)'...page 256
Pc41F	5930h	12	Slot 3 - Temperature Limit (tp1)	↪ 'Slot 1 to 10 - Temperature Limit (tp1)'...page 256
Pc420	5930h	13	Slot 3 - Temperature Limit (tp2)	↪ 'Slot 1 to 10 - Temperature Limit (tp2)'...page 257
Pc09A	580Eh	7	Encoder Absolute Position Difference E1 to E2	↪ 'Encoder Absolute Position Difference E1 to E2'...page 257
Pc09C	580Eh	8	Encoder Offset E1 to Homing Position (Origin)	↪ 'Encoder Offset E1 to Homing Position (Origin)'...page 258

Slot 4 Parameters

Parameter No.	Index (hex)	Sub-index	Parameter Name	Direct Link
Pc480	5940h	1	Slot 4 - Configuration I	↪ 'Slot 1 to 10 - Configuration I'...page 249
Pc481	5940h	2	Slot 4 - Configuration II	↪ 'Slot 1 to 10 - Configuration II'...page 250
Pc490	5940h	3	Slot 4 - Waiting Time (t1)	↪ 'Slot 1 to 10 - Waiting Time (t1)'...page 251
Pc491	5940h	4	Slot 4 - Monitoring Time (t2)	↪ 'Slot 1 to 10 - Monitoring Time (t2)'...page 252
Pc492	5940h	5	Slot 4 - Speed Limit (s1)	↪ 'Slot 1 to 10 - Speed Limit (s1)'...page 252
Pc494	5940h	6	Slot 4 - Speed Limit (s2)	↪ 'Slot 1 to 10 - Speed Limit (s2)'...page 253
Pc496	5940h	7	Slot 4 - Acceleration Limit (a1)	↪ 'Slot 1 to 10 - Acceleration Limit (a1)'...page 253
Pc498	5940h	8	Slot 4 - Distance Limit (p1)	↪ 'Slot 1 to 10 - Distance Limit (p1)'...page 254
Pc49A	5940h	9	Slot 4 - Distance Limit (p2)	↪ 'Slot 1 to 10 - Distance Limit (p2)'...page 254
Pc49C	5940h	10	Slot 4 - Distance Limit (p3)	↪ 'Slot 1 to 10 - Distance Limit (p3)'...page 255
Pc49E	5940h	11	Slot 4 - Torque Limit (tq1)	↪ 'Slot 1 to 10 - Torque Limit (tq1)'...page 256
Pc49F	5940h	12	Slot 4 - Temperature Limit (tp1)	↪ 'Slot 1 to 10 - Temperature Limit (tp1)'...page 256
Pc4A0	5940h	13	Slot 4 - Temperature Limit (tp2)	↪ 'Slot 1 to 10 - Temperature Limit (tp2)'...page 257
Pc09A	580Eh	7	Encoder Absolute Position Difference E1 to E2	↪ 'Encoder Absolute Position Difference E1 to E2'...page 257
Pc09C	580Eh	8	Encoder Offset E1 to Homing Position (Origin)	↪ 'Encoder Offset E1 to Homing Position (Origin)'...page 258

Slot 5 Parameters

Parameter No.	Index (hex)	Sub-index	Parameter Name	Direct Link
Pc500	5950h	1	Slot 5 - Configuration I	↪ 'Slot 1 to 10 - Configuration I'...page 249
Pc501	5950h	2	Slot 5 - Configuration II	↪ 'Slot 1 to 10 - Configuration II'...page 250
Pc510	5950h	3	Slot 5 - Waiting Time (t1)	↪ 'Slot 1 to 10 - Waiting Time (t1)'...page 251
Pc511	5950h	4	Slot 5 - Monitoring Time (t2)	↪ 'Slot 1 to 10 - Monitoring Time (t2)'...page 252
Pc512	5950h	5	Slot 5 - Speed Limit (s1)	↪ 'Slot 1 to 10 - Speed Limit (s1)'...page 252
Pc514	5950h	6	Slot 5 - Speed Limit (s2)	↪ 'Slot 1 to 10 - Speed Limit (s2)'...page 253

Parameter No.	Index (hex)	Sub-index	Parameter Name	Direct Link
Pc516	5950h	7	Slot 5 - Acceleration Limit (a1)	↪ 'Slot 1 to 10 - Acceleration Limit (a1)'...page 253
Pc518	5950h	8	Slot 5 - Distance Limit (p1)	↪ 'Slot 1 to 10 - Distance Limit (p1)'...page 254
Pc51A	5950h	9	Slot 5 - Distance Limit (p2)	↪ 'Slot 1 to 10 - Distance Limit (p2)'...page 254
Pc51C	5950h	10	Slot 5 - Distance Limit (p3)	↪ 'Slot 1 to 10 - Distance Limit (p3)'...page 255
Pc51E	5950h	11	Slot 5 - Torque Limit (tq1)	↪ 'Slot 1 to 10 - Torque Limit (tq1)'...page 256
Pc51F	5950h	12	Slot 5 - Temperature Limit (tp1)	↪ 'Slot 1 to 10 - Temperature Limit (tp1)'...page 256
Pc520	5950h	13	Slot 5 - Temperature Limit (tp2)	↪ 'Slot 1 to 10 - Temperature Limit (tp2)'...page 257
Pc09A	580Eh	7	Encoder Absolute Position Difference E1 to E2	↪ 'Encoder Absolute Position Difference E1 to E2'...page 257
Pc09C	580Eh	8	Encoder Offset E1 to Homing Position (Origin)	↪ 'Encoder Offset E1 to Homing Position (Origin)'...page 258

Slot 6 Parameters

Parameter No.	Index (hex)	Sub-index	Parameter Name	Direct Link
Pc580	5960h	1	Slot 6 - Configuration I	↪ 'Slot 1 to 10 - Configuration I'...page 249
Pc581	5960h	2	Slot 6 - Configuration II	↪ 'Slot 1 to 10 - Configuration II'...page 250
Pc590	5960h	3	Slot 6 - Waiting Time (t1)	↪ 'Slot 1 to 10 - Waiting Time (t1)'...page 251
Pc591	5960h	4	Slot 6 - Monitoring Time (t2)	↪ 'Slot 1 to 10 - Monitoring Time (t2)'...page 252
Pc592	5960h	5	Slot 6 - Speed Limit (s1)	↪ 'Slot 1 to 10 - Speed Limit (s1)'...page 252
Pc594	5960h	6	Slot 6 - Speed Limit (s2)	↪ 'Slot 1 to 10 - Speed Limit (s2)'...page 253
Pc596	5960h	7	Slot 6 - Acceleration Limit (a1)	↪ 'Slot 1 to 10 - Acceleration Limit (a1)'...page 253
Pc598	5960h	8	Slot 6 - Distance Limit (p1)	↪ 'Slot 1 to 10 - Distance Limit (p1)'...page 254
Pc59A	5960h	9	Slot 6 - Distance Limit (p2)	↪ 'Slot 1 to 10 - Distance Limit (p2)'...page 254
Pc59C	5960h	10	Slot 6 - Distance Limit (p3)	↪ 'Slot 1 to 10 - Distance Limit (p3)'...page 255
Pc59E	5960h	11	Slot 6 - Torque Limit (tq1)	↪ 'Slot 1 to 10 - Torque Limit (tq1)'...page 256
Pc59F	5960h	12	Slot 6 - Temperature Limit (tp1)	↪ 'Slot 1 to 10 - Temperature Limit (tp1)'...page 256

Safe Parameters > Slot Parameters

Parameter No.	Index (hex)	Sub-index	Parameter Name	Direct Link
Pc5A0	5960h	13	Slot 6 - Temperature Limit (tp2)	↗ 'Slot 1 to 10 - Temperature Limit (tp2)'...page 257
Pc09A	580Eh	7	Encoder Absolute Position Difference E1 to E2	↗ 'Encoder Absolute Position Difference E1 to E2'...page 257
Pc09C	580Eh	8	Encoder Offset E1 to Homing Position (Origin)	↗ 'Encoder Offset E1 to Homing Position (Origin)'...page 258

Slot 7 Parameters

Parameter No.	Index (hex)	Sub-index	Parameter Name	Direct Link
Pc600	5970h	1	Slot 7 - Configuration I	↗ 'Slot 1 to 10 - Configuration I'...page 249
Pc601	5970h	2	Slot 7 - Configuration II	↗ 'Slot 1 to 10 - Configuration II'...page 250
Pc610	5970h	3	Slot 7 - Waiting Time (t1)	↗ 'Slot 1 to 10 - Waiting Time (t1)'...page 251
Pc611	5970h	4	Slot 7 - Monitoring Time (t2)	↗ 'Slot 1 to 10 - Monitoring Time (t2)'...page 252
Pc612	5970h	5	Slot 7 - Speed Limit (s1)	↗ 'Slot 1 to 10 - Speed Limit (s1)'...page 252
Pc614	5970h	6	Slot 7 - Speed Limit (s2)	↗ 'Slot 1 to 10 - Speed Limit (s2)'...page 253
Pc616	5970h	7	Slot 7 - Acceleration Limit (a1)	↗ 'Slot 1 to 10 - Acceleration Limit (a1)'...page 253
Pc618	5970h	8	Slot 7 - Distance Limit (p1)	↗ 'Slot 1 to 10 - Distance Limit (p1)'...page 254
Pc61A	5970h	9	Slot 7 - Distance Limit (p2)	↗ 'Slot 1 to 10 - Distance Limit (p2)'...page 254
Pc61C	5970h	10	Slot 7 - Distance Limit (p3)	↗ 'Slot 1 to 10 - Distance Limit (p3)'...page 255
Pc61E	5970h	11	Slot 7 - Torque Limit (tq1)	↗ 'Slot 1 to 10 - Torque Limit (tq1)'...page 256
Pc61F	5970h	12	Slot 7 - Temperature Limit (tp1)	↗ 'Slot 1 to 10 - Temperature Limit (tp1)'...page 256
Pc620	5970h	13	Slot 7 - Temperature Limit (tp2)	↗ 'Slot 1 to 10 - Temperature Limit (tp2)'...page 257
Pc09A	580Eh	7	Encoder Absolute Position Difference E1 to E2	↗ 'Encoder Absolute Position Difference E1 to E2'...page 257
Pc09C	580Eh	8	Encoder Offset E1 to Homing Position (Origin)	↗ 'Encoder Offset E1 to Homing Position (Origin)'...page 258

Slot 8 Parameters

Parameter No.	Index (hex)	Sub-index	Parameter Name	Direct Link
Pc680	5980h	1	Slot 8 - Configuration I	↗ 'Slot 1 to 10 - Configuration I'...page 249

Parameter No.	Index (hex)	Sub-index	Parameter Name	Direct Link
Pc681	5980h	2	Slot 8 - Configuration II	↪ 'Slot 1 to 10 - Configuration II'...page 250
Pc690	5980h	3	Slot 8 - Waiting Time (t1)	↪ 'Slot 1 to 10 - Waiting Time (t1)'...page 251
Pc691	5980h	4	Slot 8 - Monitoring Time (t2)	↪ 'Slot 1 to 10 - Monitoring Time (t2)'...page 252
Pc692	5980h	5	Slot 8 - Speed Limit (s1)	↪ 'Slot 1 to 10 - Speed Limit (s1)'...page 252
Pc694	5980h	6	Slot 8 - Speed Limit (s2)	↪ 'Slot 1 to 10 - Speed Limit (s2)'...page 253
Pc696	5980h	7	Slot 8 - Acceleration Limit (a1)	↪ 'Slot 1 to 10 - Acceleration Limit (a1)'...page 253
Pc698	5980h	8	Slot 8 - Distance Limit (p1)	↪ 'Slot 1 to 10 - Distance Limit (p1)'...page 254
Pc69A	5980h	9	Slot 8 - Distance Limit (p2)	↪ 'Slot 1 to 10 - Distance Limit (p2)'...page 254
Pc69C	5980h	10	Slot 8 - Distance Limit (p3)	↪ 'Slot 1 to 10 - Distance Limit (p3)'...page 255
Pc69E	5980h	11	Slot 8 - Torque Limit (tq1)	↪ 'Slot 1 to 10 - Torque Limit (tq1)'...page 256
Pc69F	5980h	12	Slot 8 - Temperature Limit (tp1)	↪ 'Slot 1 to 10 - Temperature Limit (tp1)'...page 256
Pc6A0	5980h	13	Slot 8 - Temperature Limit (tp2)	↪ 'Slot 1 to 10 - Temperature Limit (tp2)'...page 257
Pc09A	580Eh	7	Encoder Absolute Position Difference E1 to E2	↪ 'Encoder Absolute Position Difference E1 to E2'...page 257
Pc09C	580Eh	8	Encoder Offset E1 to Homing Position (Origin)	↪ 'Encoder Offset E1 to Homing Position (Origin)'...page 258

Slot 9 Parameters

Parameter No.	Index (hex)	Sub-index	Parameter Name	Direct Link
Pc700	5990h	1	Slot 9 - Configuration I	↪ 'Slot 1 to 10 - Configuration I'...page 249
Pc701	5990h	2	Slot 9 - Configuration II	↪ 'Slot 1 to 10 - Configuration II'...page 250
Pc710	5990h	3	Slot 9 - Waiting Time (t1)	↪ 'Slot 1 to 10 - Waiting Time (t1)'...page 251
Pc711	5990h	4	Slot 9 - Monitoring Time (t2)	↪ 'Slot 1 to 10 - Monitoring Time (t2)'...page 252
Pc712	5990h	5	Slot 9 - Speed Limit (s1)	↪ 'Slot 1 to 10 - Speed Limit (s1)'...page 252
Pc714	5990h	6	Slot 9 - Speed Limit (s2)	↪ 'Slot 1 to 10 - Speed Limit (s2)'...page 253
Pc716	5990h	7	Slot 9 - Acceleration Limit (a1)	↪ 'Slot 1 to 10 - Acceleration Limit (a1)'...page 253

Safe Parameters > Slot Parameters

Parameter No.	Index (hex)	Sub-index	Parameter Name	Direct Link
Pc718	5990h	8	Slot 9 - Distance Limit (p1)	↗ 'Slot 1 to 10 - Distance Limit (p1)'...page 254
Pc71A	5990h	9	Slot 9 - Distance Limit (p2)	↗ 'Slot 1 to 10 - Distance Limit (p2)'...page 254
Pc71C	5990h	10	Slot 9 - Distance Limit (p3)	↗ 'Slot 1 to 10 - Distance Limit (p3)'...page 255
Pc71E	5990h	11	Slot 9 - Torque Limit (tq1)	↗ 'Slot 1 to 10 - Torque Limit (tq1)'...page 256
Pc71F	5990h	12	Slot 9 - Temperature Limit (tp1)	↗ 'Slot 1 to 10 - Temperature Limit (tp1)'...page 256
Pc720	5990h	13	Slot 9 - Temperature Limit (tp2)	↗ 'Slot 1 to 10 - Temperature Limit (tp2)'...page 257
Pc09A	580Eh	7	Encoder Absolute Position Difference E1 to E2	↗ 'Encoder Absolute Position Difference E1 to E2'...page 257
Pc09C	580Eh	8	Encoder Offset E1 to Homing Position (Origin)	↗ 'Encoder Offset E1 to Homing Position (Origin)'...page 258

Slot 10 Parameters

Parameter No.	Index (hex)	Sub-index	Parameter Name	Direct Link
Pc780	59A0h	1	Slot 10 - Configuration I	↗ 'Slot 1 to 10 - Configuration I'...page 249
Pc781	59A0h	2	Slot 10 - Configuration II	↗ 'Slot 1 to 10 - Configuration II'...page 250
Pc790	59A0h	3	Slot 10 - Waiting Time (t1)	↗ 'Slot 1 to 10 - Waiting Time (t1)'...page 251
Pc791	59A0h	4	Slot 10 - Monitoring Time (t2)	↗ 'Slot 1 to 10 - Monitoring Time (t2)'...page 252
Pc792	59A0h	5	Slot 10 - Speed Limit (s1)	↗ 'Slot 1 to 10 - Speed Limit (s1)'...page 252
Pc794	59A0h	6	Slot 10 - Speed Limit (s2)	↗ 'Slot 1 to 10 - Speed Limit (s2)'...page 253
Pc796	59A0h	7	Slot 10 - Acceleration Limit (a1)	↗ 'Slot 1 to 10 - Acceleration Limit (a1)'...page 253
Pc798	59A0h	8	Slot 10 - Distance Limit (p1)	↗ 'Slot 1 to 10 - Distance Limit (p1)'...page 254
Pc79A	59A0h	9	Slot 10 - Distance Limit (p2)	↗ 'Slot 1 to 10 - Distance Limit (p2)'...page 254
Pc79C	59A0h	10	Slot 10 - Distance Limit (p3)	↗ 'Slot 1 to 10 - Distance Limit (p3)'...page 255
Pc79E	59A0h	11	Slot 10 - Torque Limit (tq1)	↗ 'Slot 1 to 10 - Torque Limit (tq1)'...page 256
Pc79F	59A0h	12	Slot 10 - Temperature Limit (tp1)	↗ 'Slot 1 to 10 - Temperature Limit (tp1)'...page 256
Pc7A0	59A0h	13	Slot 10 - Temperature Limit (tp2)	↗ 'Slot 1 to 10 - Temperature Limit (tp2)'...page 257

Parameter No.	Index (hex)	Sub-index	Parameter Name	Direct Link
Pc09A	580Eh	7	Encoder Absolute Position Difference E1 to E2	↪ 'Encoder Absolute Position Difference E1 to E2'...page 257
Pc09C	580Eh	8	Encoder Offset E1 to Homing Position (Origin)	↪ 'Encoder Offset E1 to Homing Position (Origin)'...page 258

A.2.5.1 Detailed Parameter Description of Slot Parameters

This chapter describes the parameter used in the function slots in detail.

Slot 1 to 10 - Configuration I

Parameter No.	Slot	Index (hex)	Sub-index	Data Type	Access	Setting Range	Setting Unit	Default Setting
Pc300	1	5910h	1	UINT	RO	0000h to 4B12h	–	0000h
Pc380	2	5920h	1	UINT	RO	0000h to 4B12h	–	0000h
Pc400	3	5930h	1	UINT	RO	0000h to 4B12h	–	0000h
Pc480	4	5940h	1	UINT	RO	0000h to 4B12h	–	0000h
Pc500	5	5950h	1	UINT	RO	0000h to 4B12h	–	0000h
Pc580	6	5960h	1	UINT	RO	0000h to 4B12h	–	0000h
Pc600	7	5970h	1	UINT	RO	0000h to 4B12h	–	0000h
Pc680	8	5980h	1	UINT	RO	0000h to 4B12h	–	0000h
Pc700	9	5990h	1	UINT	RO	0000h to 4B12h	–	0000h
Pc780	10	59A0h	1	UINT	RO	0000h to 4B12h	–	0000h



This parameter must be written via the Yaskawa software "Advanced Safety Module Parameter Editor".

Digit	Name	Units R: Rotary L: Linear	Range	Default
0 - 1	Safety Function Selection	–	00h to 12h	00h
	00h: None 01h: Mapping (Reserved) 02h: STO 03h: SS1-r 04h: SS1-t 05h: SS2-r 06h: SS2-t 07h: SOS 08h: SLS 09h: SLA 0Ah: SSR 0Bh: SDI 0Ch: SLP 0Dh: SLI 0Eh: SLT 0Fh: SMT 10h: SCA 11h: SSM 12h: SHP			
2	Data Input	–	0h to Bh	0h

Digit	Name	Units R: Rotary L: Linear	Range	Default
	0: None 1: Safe Port A 2: Safe Port B 3: Safe Port C 4: Safe Port D 5: Safe Port E			
	6: Safe Port F 7: Reserved 8: Reserved 9: Virtual Input 0 A: Virtual Input 1 B: Virtual Input 2			
3	Output Signal Behavior	–	0h to 4h	0h
	0: None 1: Active during operation 2: Active during working safety function 3: Active after limit violation 4: Active during safe state			

Slot 1 to 10 - Configuration II

Parameter No.	Slot	Index (hex)	Sub-index	Data Type	Access	Setting Range	Setting Unit	Default Setting
Pc301	1	5910h	2	UINT	RO	0000h to 2F39h	–	0000h
Pc381	2	5920h	2	UINT	RO	0000h to 2F39h	–	0000h
Pc401	3	5930h	2	UINT	RO	0000h to 2F39h	–	0000h
Pc481	4	5940h	2	UINT	RO	0000h to 2F39h	–	0000h
Pc501	5	5950h	2	UINT	RO	0000h to 2F39h	–	0000h
Pc581	6	5960h	2	UINT	RO	0000h to 2F39h	–	0000h
Pc601	7	5970h	2	UINT	RO	0000h to 2F39h	–	0000h
Pc681	8	5980h	2	UINT	RO	0000h to 2F39h	–	0000h
Pc701	9	5990h	2	UINT	RO	0000h to 2F39h	–	0000h
Pc781	10	59A0h	2	UINT	RO	0000h to 2F39h	–	0000h



This parameter must be written via the Yaskawa software "Advanced Safety Module Parameter Editor".

Digit	Name	Units R: Rotary L: Linear	Range	Default
0 - 1	Activation Input	–	00h to 39h	00h

Digit	Name	Units R: Rotary L: Linear	Range	Default
	00: Disable 01: Enable 02: Safe Port A 03: Safe Port B 04: Safe Port C 05: Safe Port D 06: Safe Port E 07: Safe Port F 10: Virtual Input 0 11: Virtual Input 1 12: Virtual Input 2 13: Virtual Input 3 14: Virtual Input 4 15: Virtual Input 5 16: Virtual Input 6 17: Virtual Input 7 18: Virtual Input 8	19: Virtual Input 9 1A: Virtual Input 10 1B: Virtual Input 11 1C: Virtual Input 12 1D: Virtual Input 13 1E: Virtual Input 14 1F: Virtual Input 15 30: Limit Violation 1 31: Limit Violation 2 32: Limit Violation 3 33: Limit Violation 4 34: Limit Violation 5 35: Limit Violation 6 36: Limit Violation 7 37: Limit Violation 8 38: Limit Violation 9 39: Limit Violation 10		
2 - 3	Output Signal Type	–	00h to 2Fh	00h
	00: None 01: Port A1 02: Port A2 03: Port B1 04: Port B2 05: Port C1 06: Port C2 07: Port D1 08: Port D2 10: Safe Port A 11: Safe Port B 12: Safe Port C 13: Safe Port D 20: Virtual Output 0 21: Virtual Output 1	22: Virtual Output 2 23: Virtual Output 3 24: Virtual Output 4 25: Virtual Output 5 26: Virtual Output 6 27: Virtual Output 7 28: Virtual Output 8 29: Virtual Output 9 2A: Virtual Output 10 2B: Virtual Output 11 2C: Virtual Output 12 2D: Virtual Output 13 2E: Virtual Output 14 2F: Virtual Output 15		

Slot 1 to 10 - Waiting Time (t1)

Parameter No.	Slot	Index (hex)	Sub-index	Data Type	Access	Setting Range	Setting Unit	Default Setting
Pc310	1	5910h	3	UINT	RO	0 to 10000	10 ms	0
Pc390	2	5920h	3	UINT	RO	0 to 10000	10 ms	0
Pc410	3	5930h	3	UINT	RO	0 to 10000	10 ms	0
Pc490	4	5940h	3	UINT	RO	0 to 10000	10 ms	0
Pc510	5	5950h	3	UINT	RO	0 to 10000	10 ms	0
Pc590	6	5960h	3	UINT	RO	0 to 10000	10 ms	0
Pc610	7	5970h	3	UINT	RO	0 to 10000	10 ms	0
Pc690	8	5980h	3	UINT	RO	0 to 10000	10 ms	0
Pc710	9	5990h	3	UINT	RO	0 to 10000	10 ms	0
Pc790	10	59A0h	3	UINT	RO	0 to 10000	10 ms	0



This parameter must be written via the Yaskawa software "Advanced Safety Module Parameter Editor".

For safety function SHP only, the minimum value for Waiting Time (t1) is 50 ms.

Slot 1 to 10 - Monitoring Time (t2)

Parameter No.	Slot	Index (hex)	Sub-index	Data Type	Access	Setting Range	Setting Unit	Default Setting
Pc311	1	5910h	4	UINT	RO	0 to 10000	10 ms	0
Pc391	2	5920h	4	UINT	RO	0 to 10000	10 ms	0
Pc411	3	5930h	4	UINT	RO	0 to 10000	10 ms	0
Pc491	4	5940h	4	UINT	RO	0 to 10000	10 ms	0
Pc511	5	5950h	4	UINT	RO	0 to 10000	10 ms	0
Pc591	6	5960h	4	UINT	RO	0 to 10000	10 ms	0
Pc611	7	5970h	4	UINT	RO	0 to 10000	10 ms	0
Pc691	8	5980h	4	UINT	RO	0 to 10000	10 ms	0
Pc711	9	5990h	4	UINT	RO	0 to 10000	10 ms	0
Pc791	10	59A0h	4	UINT	RO	0 to 10000	10 ms	0



This parameter must be written via the Yaskawa software "Advanced Safety Module Parameter Editor".

Slot 1 to 10 - Speed Limit (s1)

Parameter No.	Slot	Index (hex)	Sub-index	Data Type	Access	Setting Range	Setting Unit	Default Setting
Pc312	1	5910h	5	UDINT	RO	0 to 4294967295	Vel. unit	0
Pc392	2	5920h	5	UDINT	RO	0 to 4294967295	Vel. unit	0
Pc412	3	5930h	5	UDINT	RO	0 to 4294967295	Vel. unit	0
Pc492	4	5940h	5	UDINT	RO	0 to 4294967295	Vel. unit	0
Pc512	5	5950h	5	UDINT	RO	0 to 4294967295	Vel. unit	0
Pc592	6	5960h	5	UDINT	RO	0 to 4294967295	Vel. unit	0
Pc612	7	5970h	5	UDINT	RO	0 to 4294967295	Vel. unit	0
Pc692	8	5980h	5	UDINT	RO	0 to 4294967295	Vel. unit	0
Pc712	9	5990h	5	UDINT	RO	0 to 4294967295	Vel. unit	0
Pc792	10	59A0h	5	UDINT	RO	0 to 4294967295	Vel. unit	0



This parameter must be written via the Yaskawa software "Advanced Safety Module Parameter Editor".

Slot 1 to 10 - Speed Limit (s2)

Parameter No.	Slot	Index (hex)	Sub-index	Data Type	Access	Setting Range	Setting Unit	Default Setting
Pc314	1	5910h	6	UDINT	RO	0 to 4294967295	Vel. unit	0
Pc394	2	5920h	6	UDINT	RO	0 to 4294967295	Vel. unit	0
Pc414	3	5930h	6	UDINT	RO	0 to 4294967295	Vel. unit	0
Pc494	4	5940h	6	UDINT	RO	0 to 4294967295	Vel. unit	0
Pc514	5	5950h	6	UDINT	RO	0 to 4294967295	Vel. unit	0
Pc594	6	5960h	6	UDINT	RO	0 to 4294967295	Vel. unit	0
Pc614	7	5970h	6	UDINT	RO	0 to 4294967295	Vel. unit	0
Pc694	8	5980h	6	UDINT	RO	0 to 4294967295	Vel. unit	0
Pc714	9	5990h	6	UDINT	RO	0 to 4294967295	Vel. unit	0
Pc794	10	59A0h	6	UDINT	RO	0 to 4294967295	Vel. unit	0



This parameter must be written via the Yaskawa software "Advanced Safety Module Parameter Editor".

Slot 1 to 10 - Acceleration Limit (a1)

Parameter No.	Slot	Index (hex)	Sub-index	Data Type	Access	Setting Range	Setting Unit	Default Setting
Pc316	1	5910h	7	DINT	RO	-2147483648 to 2147483647	Acc. unit	0
Pc396	2	5920h	7	DINT	RO	-2147483648 to 2147483647	Acc. unit	0
Pc416	3	5930h	7	DINT	RO	-2147483648 to 2147483647	Acc. unit	0
Pc496	4	5940h	7	DINT	RO	-2147483648 to 2147483647	Acc. unit	0
Pc516	5	5950h	7	DINT	RO	-2147483648 to 2147483647	Acc. unit	0
Pc596	6	5960h	7	DINT	RO	-2147483648 to 2147483647	Acc. unit	0
Pc616	7	5970h	7	DINT	RO	-2147483648 to 2147483647	Acc. unit	0
Pc696	8	5980h	7	DINT	RO	-2147483648 to 2147483647	Acc. unit	0

Safe Parameters > Slot Parameters

Parameter No.	Slot	Index (hex)	Sub-index	Data Type	Access	Setting Range	Setting Unit	Default Setting
Pc716	9	5990h	7	DINT	RO	-2147483648 to 2147483647	Acc. unit	0
Pc796	10	59A0h	7	DINT	RO	-2147483648 to 2147483647	Acc. unit	0



This parameter must be written via the Yaskawa software "Advanced Safety Module Parameter Editor".

Slot 1 to 10 - Distance Limit (p1)

Parameter No.	Slot	Index (hex)	Sub-index	Data Type	Access	Setting Range	Setting Unit	Default Setting
Pc318	1	5910h	8	DINT	RO	-2147483648 to 2147483647	Pos. unit	0
Pc398	2	5920h	8	DINT	RO	-2147483648 to 2147483647	Pos. unit	0
Pc418	3	5930h	8	DINT	RO	-2147483648 to 2147483647	Pos. unit	0
Pc498	4	5940h	8	DINT	RO	-2147483648 to 2147483647	Pos. unit	0
Pc518	5	5950h	8	DINT	RO	-2147483648 to 2147483647	Pos. unit	0
Pc598	6	5960h	8	DINT	RO	-2147483648 to 2147483647	Pos. unit	0
Pc618	7	5970h	8	DINT	RO	-2147483648 to 2147483647	Pos. unit	0
Pc698	8	5980h	8	DINT	RO	-2147483648 to 2147483647	Pos. unit	0
Pc718	9	5990h	8	DINT	RO	-2147483648 to 2147483647	Pos. unit	0
Pc798	10	59A0h	8	DINT	RO	-2147483648 to 2147483647	Pos. unit	0



This parameter must be written via the Yaskawa software "Advanced Safety Module Parameter Editor".

Slot 1 to 10 - Distance Limit (p2)

Parameter No.	Slot	Index (hex)	Sub-index	Data Type	Access	Setting Range	Setting Unit	Default Setting
Pc31A	1	5910h	9	DINT	RO	-2147483648 to 2147483647	Pos. unit	0

Parameter No.	Slot	Index (hex)	Sub-index	Data Type	Access	Setting Range	Setting Unit	Default Setting
Pc39A	2	5920h	9	DINT	RO	-2147483648 to 2147483647	Pos. unit	0
Pc41A	3	5930h	9	DINT	RO	-2147483648 to 2147483647	Pos. unit	0
Pc49A	4	5940h	9	DINT	RO	-2147483648 to 2147483647	Pos. unit	0
Pc51A	5	5950h	9	DINT	RO	-2147483648 to 2147483647	Pos. unit	0
Pc59A	6	5960h	9	DINT	RO	-2147483648 to 2147483647	Pos. unit	0
Pc61A	7	5970h	9	DINT	RO	-2147483648 to 2147483647	Pos. unit	0
Pc69A	8	5980h	9	DINT	RO	-2147483648 to 2147483647	Pos. unit	0
Pc71A	9	5990h	9	DINT	RO	-2147483648 to 2147483647	Pos. unit	0
Pc79A	10	59A0h	9	DINT	RO	-2147483648 to 2147483647	Pos. unit	0



This parameter must be written via the Yaskawa software "Advanced Safety Module Parameter Editor".

Slot 1 to 10 - Distance Limit (p3)

Parameter No.	Slot	Index (hex)	Sub-index	Data Type	Access	Setting Range	Setting Unit	Default Setting
Pc31C	1	5910h	10	UDINT	RO	0 to 4294967295	Pos. unit	0
Pc39C	2	5920h	10	UDINT	RO	0 to 4294967295	Pos. unit	0
Pc41C	3	5930h	10	UDINT	RO	0 to 4294967295	Pos. unit	0
Pc49C	4	5940h	10	UDINT	RO	0 to 4294967295	Pos. unit	0
Pc51C	5	5950h	10	UDINT	RO	0 to 4294967295	Pos. unit	0
Pc59C	6	5960h	10	UDINT	RO	0 to 4294967295	Pos. unit	0
Pc61C	7	5970h	10	UDINT	RO	0 to 4294967295	Pos. unit	0
Pc69C	8	5980h	10	UDINT	RO	0 to 4294967295	Pos. unit	0
Pc71C	9	5990h	10	UDINT	RO	0 to 4294967295	Pos. unit	0
Pc79C	10	59A0h	10	UDINT	RO	0 to 4294967295	Pos. unit	0



This parameter must be written via the Yaskawa software "Advanced Safety Module Parameter Editor".

Slot 1 to 10 - Torque Limit (tq1)

Parameter No.	Slot	Index (hex)	Sub-index	Data Type	Access	Setting Range	Setting Unit	Default Setting
Pc31E	1	5910h	11	UINT	RO	0 to 10000	*1	0
Pc39E	2	5920h	11	UINT	RO	0 to 10000	*1	0
Pc41E	3	5930h	11	UINT	RO	0 to 10000	*1	0
Pc49E	4	5940h	11	UINT	RO	0 to 10000	*1	0
Pc51E	5	5950h	11	UINT	RO	0 to 10000	*1	0
Pc59E	6	5960h	11	UINT	RO	0 to 10000	*1	0
Pc61E	7	5970h	11	UINT	RO	0 to 10000	*1	0
Pc69E	8	5980h	11	UINT	RO	0 to 10000	*1	0
Pc71E	9	5990h	11	UINT	RO	0 to 10000	*1	0
Pc79E	10	59A0h	11	UINT	RO	0 to 10000	*1	0



This parameter must be written via the Yaskawa software "Advanced Safety Module Parameter Editor".

*1: Unit depends on the selected input port in the safety slot setting:

- Port F (0-10 V): 1 mV
- Port G1 (4-20 mA): 2 μ A

Slot 1 to 10 - Temperature Limit (tp1)

Parameter No.	Slot	Index (hex)	Sub-index	Data Type	Access	Setting Range	Setting Unit	Default Setting
Pc31F	1	5910h	12	UINT	RO	0 to 2000	*1	0
Pc39F	2	5920h	12	UINT	RO	0 to 2000	*1	0
Pc41F	3	5930h	12	UINT	RO	0 to 2000	*1	0
Pc49F	4	5940h	12	UINT	RO	0 to 2000	*1	0
Pc51F	5	5950h	12	UINT	RO	0 to 2000	*1	0
Pc59F	6	5960h	12	UINT	RO	0 to 2000	*1	0
Pc61F	7	5970h	12	UINT	RO	0 to 2000	*1	0
Pc69F	8	5980h	12	UINT	RO	0 to 2000	*1	0
Pc71F	9	5990h	12	UINT	RO	0 to 2000	*1	0
Pc79F	10	59A0h	12	UINT	RO	0 to 2000	*1	0



This parameter must be written via the Yaskawa software "Advanced Safety Module Parameter Editor".

*1: Unit depends on the selected input port in the safety slot setting:

- Port F (0-10 V): 5 mV
- Port G1 (4-20 mA): 10 µA
- Port G2 (PT1000): 0.1 °C

Slot 1 to 10 - Temperature Limit (tp2)

Parameter No.	Slot	Index (hex)	Sub-index	Data Type	Access	Setting Range	Setting Unit	Default Setting
Pc320	1	5910h	13	UINT	RO	0 to 2000	*1	0
Pc3A0	2	5920h	13	UINT	RO	0 to 2000	*1	0
Pc420	3	5930h	13	UINT	RO	0 to 2000	*1	0
Pc4A0	4	5940h	13	UINT	RO	0 to 2000	*1	0
Pc520	5	5950h	13	UINT	RO	0 to 2000	*1	0
Pc5A0	6	5960h	13	UINT	RO	0 to 2000	*1	0
Pc620	7	5970h	13	UINT	RO	0 to 2000	*1	0
Pc6A0	8	5980h	13	UINT	RO	0 to 2000	*1	0
Pc720	9	5990h	13	UINT	RO	0 to 2000	*1	0
Pc7A0	10	59A0h	13	UINT	RO	0 to 2000	*1	0



This parameter must be written via the Yaskawa software "Advanced Safety Module Parameter Editor".

*1: Unit depends on the selected input port in the safety slot setting:

- Port F (0-10 V): 5 mV
- Port G1 (4-20 mA): 10 µA
- Port G2 (PT1000): 0.1 °C

Encoder Absolute Position Difference E1 to E2

When using **rotary absolute encoders** with a **gearing factor of 1:1** between both encoder systems, **SHP Status** can remain high after first successful homing. Only in this case, this parameter is used when checking the encoder deviation at start-up. During normal running encoder deviation Pc097 is used.

Parameter No.	Index (hex)	Subindex	Data Type	Access	Setting Range	Setting Unit	Default Setting
Pc09A	580Eh	7	DINT	RO	1 to 179	Rotational play in degrees	1



This parameter must be written via the Yaskawa software "Advanced Safety Module Parameter Editor".

Encoder Offset E1 to Homing Position (Origin)

Parameter No.	Index (hex)	Subindex	Data Type	Access	Setting Range	Setting Unit	Default Setting
Pc09C	580Eh	8	DINT	RO	-2147483648 to 2147483647	Pos. unit	0



This parameter must be written via the Yaskawa software "Advanced Safety Module Parameter Editor".

A.3 FSoE Parameters

In this chapter, the relevant FSoE parameters are listed. These parameters are the device parameters of the safety module. They are not included in the FSoE communication itself, but only used for the application layer above.

A.3.1 Communication Objects

Communication Objects

Index (hex)	Sub-index	Parameter Name	Direct Link
1608h	1 to 32	RxPDO Mapping of FSoE Slave, Mapping entry 1 to Mapping entry 32	↪ 'RxPDO Mapping of FSoE Slave, Mapping entry 1 to Mapping entry 32'...page 259
1A08h	1 to 64	TxPDO Mapping of FSoE Slave, Mapping entry 1 to Mapping entry 64	↪ 'TxPDO Mapping of FSoE Slave, Mapping entry 1 to Mapping entry 64'...page 260
1E00h	1 to 3	FSoE Connection Parameter Set Mapping, Mapping entry 1 to Mapping entry 3	↪ 'FSoE Connection Parameter Set Mapping, Mapping entry (1 to 3)'...page 262
E600h	1	FSoE Slave Frame Elements, FSoE Slave Command	↪ 'FFSoE Slave Frame Elements, FSoE Slave Command'...page 262
E600h	2	FSoE Slave Frame Elements, FSoE Slave Connection ID	↪ 'FSoE Slave Frame Elements, FSoE Slave Connection ID'...page 263
E600h	3 to 10	FSoE Slave Frame Elements, FSoE Slave CRC_0 to FSoE Slave CRC_7	↪ 'FSoE Slave Frame Elements, FSoE Slave CRC_0 to FSoE Slave CRC_7'...page 263
E700h	1	FSoE Master Frame Elements, FSoE Master Command	↪ 'FSoE Master Frame Elements, FSoE Master Command'...page 263
E700h	2	FSoE Master Frame Elements, FSoE Master Connection ID	↪ 'FSoE Master Frame Elements, FSoE Master Connection ID'...page 263
E700h	3 to 10	FSoE Master Frame Elements, FSoE Master CRC_0 to FSoE Master CRC_7	↪ 'FSoE Master Frame Elements, FSoE Master CRC_0 to FSoE Master CRC_7'...page 263
E900h	1	FSoE Info Data, FSoE Module Connection ID	↪ 'FSoE Info Data, FSoE Module Connection ID'...page 263
E900h	2	FSoE Info Data, FSoE Module Type	↪ 'FSoE Info Data, FSoE Module Type'...page 264
E900h	3	FSoE Info Data, FSoE Module Name	↪ 'FSoE Info Data, FSoE Module Name'...page 264
E900h	4	FSoE Info Data, FSoE Module Device Type	↪ 'FSoE Info Data, FSoE Module Device Type'...page 264

Index (hex)	Sub-index	Parameter Name	Direct Link
E900h	5	FSoE Info Data, FSoE Module Vendor ID	↪ 'FSoE Info Data, FSoE Module Vendor ID'...page 264
E900h	6	FSoE Info Data, FSoE Module Product Code	↪ 'FSoE Info Data, FSoE Module Product Code'...page 264
E900h	7	FSoE Info Data, FSoE Module Revision Number	↪ 'FSoE Info Data, FSoE Module Revision Number'...page 264
E900h	8	FSoE Info Data, FSoE Module Serial Number	↪ 'FSoE Info Data, FSoE Module Serial Number'...page 264
E901h	1	FSoE Communication Parameter, FSoE Version	↪ 'FSoE Communication Parameter, FSoE Version'...page 265
E901h	2	FSoE Communication Parameter, Safety Address	↪ 'FSoE Communication Parameter, Safety Address'...page 265
E901h	3	FSoE Communication Parameter, FSoE Connection ID	↪ 'FSoE Communication Parameter, FSoE Connection ID'...page 265
E901h	4	FSoE Communication Parameter, Watchdog Time	↪ 'FSoE Communication Parameter, Watchdog Time'...page 265
E901h	6	FSoE Communication Parameter, Connection Type	↪ 'FSoE Communication Parameter, Connection Type'...page 265
E901h	7	FSoE Communication Parameter, Communication Parameter Length	↪ 'FSoE Communication Parameter, Communication Parameter Length'...page 265
E901h	8	FSoE Communication Parameter, Application Parameter Length	↪ 'FSoE Communication Parameter, Application Parameter Length'...page 265
EA00h	1	FSoE CFSoE Connection Diagnosis, Connection State	↪ 'FSoE Connection Diagnosis, Connection State'...page 265
EA00h	2	FSoE CFSoE Connection Diagnosis, Connection Diagnosis	↪ 'FSoE Connection Diagnosis, Connection Diagnosis'...page 266

A.3.1.1 Detailed Parameter Description of Communication Objects

RxPDO Mapping of FSoE Slave, Mapping entry 1 to Mapping entry 32

Index (hex)	Subindex	Data Type	Access	Setting Range	Default Setting
1608h	1	UDINT	RO	–	E7000108h
1608h	2	UDINT	RO	–	5A000101h
1608h	3	UDINT	RO	–	5A000201h
1608h	4	UDINT	RO	–	5A000301h
1608h	5	UDINT	RO	–	5A000401h
1608h	6	UDINT	RO	–	5A000501h
1608h	7	UDINT	RO	–	5A000601h
1608h	8	UDINT	RO	–	5A000701h
1608h	9	UDINT	RO	–	5A000801h
1608h	10	UDINT	RO	–	5A000901h
1608h	11	UDINT	RO	–	5A000A01h
1608h	12	UDINT	RO	–	5A000B01h

Index (hex)	Subindex	Data Type	Access	Setting Range	Default Setting
1608h	13	UDINT	RO	–	5A000C01h
1608h	14	UDINT	RO	–	5A000D01h
1608h	15	UDINT	RO	–	5A000E01h
1608h	16	UDINT	RO	–	5A000F01h
1608h	17	UDINT	RO	–	5A001001h
1608h	18	UDINT	RO	–	E7000310h
1608h	19	UDINT	RO	–	5A040101h
1608h	20	UDINT	RO	–	5A040201h
1608h	21	UDINT	RO	–	5A040301h
1608h	22	UDINT	RO	–	5A040401h
1608h	23	UDINT	RO	–	00000003h
1608h	24	UDINT	RO	–	5A090001h
1608h	25	UDINT	RO	–	00000008h
1608h	26	UDINT	RO	–	E7000410h
1608h	27	UDINT	RO	–	E7000210h
1608h	28	UDINT	RO	–	00000000h
1608h	29	UDINT	RO	–	00000000h
1608h	30	UDINT	RO	–	00000000h
1608h	31	UDINT	RO	–	00000000h
1608h	32	UDINT	RO	–	00000000h



The mapping is preset and cannot be changed.

TxPDO Mapping of FSoE Slave, Mapping entry 1 to Mapping entry 64

Index (hex)	Subindex	Data Type	Access	Setting Range	Default Setting
1A08h	1	UDINT	RO	–	E6000108h
1A08h	2	UDINT	RO	–	5A010101h
1A08h	3	UDINT	RO	–	5A010201h
1A08h	4	UDINT	RO	–	5A010301h
1A08h	5	UDINT	RO	–	5A010401h
1A08h	6	UDINT	RO	–	5A010501h
1A08h	7	UDINT	RO	–	5A010601h
1A08h	8	UDINT	RO	–	5A010701h
1A08h	9	UDINT	RO	–	5A010801h
1A08h	10	UDINT	RO	–	5A010901h

Index (hex)	Subindex	Data Type	Access	Setting Range	Default Setting
1A08h	11	UDINT	RO	–	5A010A01h
1A08h	12	UDINT	RO	–	5A010B01h
1A08h	13	UDINT	RO	–	5A010C01h
1A08h	14	UDINT	RO	–	5A010D01h
1A08h	15	UDINT	RO	–	5A010E01h
1A08h	16	UDINT	RO	–	5A010F01h
1A08h	17	UDINT	RO	–	5A011001h
1A08h	18	UDINT	RO	–	E6000310h
1A08h	19	UDINT	RO	–	5A020101h
1A08h	20	UDINT	RO	–	5A020201h
1A08h	21	UDINT	RO	–	5A020301h
1A08h	22	UDINT	RO	–	5A020401h
1A08h	23	UDINT	RO	–	5A020501h
1A08h	24	UDINT	RO	–	5A020601h
1A08h	25	UDINT	RO	–	5A020701h
1A08h	26	UDINT	RO	–	5A020801h
1A08h	27	UDINT	RO	–	5A020901h
1A08h	28	UDINT	RO	–	5A020A01h
1A08h	29	UDINT	RO	–	5A030101h
1A08h	30	UDINT	RO	–	5A030201h
1A08h	31	UDINT	RO	–	5A030301h
1A08h	32	UDINT	RO	–	5A030401h
1A08h	33	UDINT	RO	–	5A030501h
1A08h	34	UDINT	RO	–	5A030601h
1A08h	35	UDINT	RO	–	E6000410h
1A08h	36	UDINT	RO	–	5A030701h
1A08h	37	UDINT	RO	–	5A030801h
1A08h	38	UDINT	RO	–	5A030901h
1A08h	39	UDINT	RO	–	5A030A01h
1A08h	40	UDINT	RO	–	5A030B01h
1A08h	41	UDINT	RO	–	5A030C01h
1A08h	42	UDINT	RO	–	5A030D01h
1A08h	43	UDINT	RO	–	5A030E01h
1A08h	44	UDINT	RO	–	5A050101h
1A08h	45	UDINT	RO	–	5A050201h
1A08h	46	UDINT	RO	–	5A050301h
1A08h	47	UDINT	RO	–	5A050401h
1A08h	48	UDINT	RO	–	00000002h

FSoE Parameters > Communication Objects

Index (hex)	Subindex	Data Type	Access	Setting Range	Default Setting
1A08h	49	UDINT	RO	–	5A0B0A01h
1A08h	50	UDINT	RO	–	5A080001h
1A08h	51	UDINT	RO	–	E6000510h
1A08h	52	UDINT	RO	–	5A200110h
1A08h	53	UDINT	RO	–	E6000610h
1A08h	54	UDINT	RO	–	00000110h
1A08h	55	UDINT	RO	–	E6000710h
1A08h	56	UDINT	RO	–	5A200210h
1A08h	57	UDINT	RO	–	E6000810h
1A08h	58	UDINT	RO	–	00000210h
1A08h	59	UDINT	RO	–	E6000910h
1A08h	60	UDINT	RO	–	E6000210h
1A08h	61	UDINT	RO	–	00000000h
1A08h	62	UDINT	RO	–	00000000h
1A08h	63	UDINT	RO	–	00000000h
1A08h	64	UDINT	RO	–	00000000h



The mapping is preset and cannot be changed.

FSoE Connection Parameter Set Mapping, Mapping entry (1 to 3)

Index (hex)	Subindex	Data Type	Access	Setting Range	Default Setting
1E00h	1	UDINT	RO	–	E9010710h
1E00h	2	UDINT	RO	–	E9010410h
1E00h	3	UDINT	RO	–	E9010810h



The mapping is preset and cannot be changed.

Mapping entry 1: Communication Parameter Length

Mapping entry 2: Watchdog Time

Mapping entry 3: Application Parameter Length

FFSoE Slave Frame Elements, FSoE Slave Command

Index (hex)	Subindex	Data Type	Access	Setting Range	Default Setting
E600h	1	USINT	RO	00h to FFh	–

FSoE Slave Frame Elements, FSoE Slave Connection ID

Index (hex)	Subindex	Data Type	Access	Setting Range	Default Setting
E600h	2	UINT	RO	0000h to FFFFh	–

FSoE Slave Frame Elements, FSoE Slave CRC_0 to FSoE Slave CRC_7

Index (hex)	Subindex	Data Type	Access	Setting Range	Default Setting
E600h	3	UINT	RO	0000h to FFFFh	–
E600h	4	UINT	RO	0000h to FFFFh	–
E600h	5	UINT	RO	0000h to FFFFh	–
E600h	6	UINT	RO	0000h to FFFFh	–
E600h	7	UINT	RO	0000h to FFFFh	–
E600h	8	UINT	RO	0000h to FFFFh	–
E600h	9	UINT	RO	0000h to FFFFh	–
E600h	10	UINT	RO	0000h to FFFFh	–

FSoE Master Frame Elements, FSoE Master Command

Index (hex)	Subindex	Data Type	Access	Setting Range	Default Setting
E700h	1	USINT	RO	00h to FFh	–

FSoE Master Frame Elements, FSoE Master Connection ID

Index (hex)	Subindex	Data Type	Access	Setting Range	Default Setting
E700h	2	UINT	RO	0000h to FFFFh	–

FSoE Master Frame Elements, FSoE Master CRC_0 to FSoE Master CRC_7

Index (hex)	Subindex	Data Type	Access	Setting Range	Default Setting
E700h	3	UINT	RO	0000h to FFFFh	–
E700h	4	UINT	RO	0000h to FFFFh	–
E700h	5	UINT	RO	0000h to FFFFh	–
E700h	6	UINT	RO	0000h to FFFFh	–
E700h	7	UINT	RO	0000h to FFFFh	–
E700h	8	UINT	RO	0000h to FFFFh	–
E700h	9	UINT	RO	0000h to FFFFh	–
E700h	10	UINT	RO	0000h to FFFFh	–

FSoE Info Data, FSoE Module Connection ID

Index (hex)	Subindex	Data Type	Access	Setting Range	Default Setting
E900h	1	UINT	RO	0000h to FFFFh	–

FSoE Parameters > Communication Objects

FSoE Info Data, FSoE Module Type

Index (hex)	Subindex	Data Type	Access	Setting Range	Default Setting
E900h	2	STRING(4)	RO	0B01h to 0B02h	–

FSoE Info Data, FSoE Module Name

Index (hex)	Subindex	Data Type	Access	Setting Range	Default Setting
E900h	3	STRING(24)	RO	SGD7S-OSB01A to SGD7S-OSB02A	–

FSoE Info Data, FSoE Module Device Type

Index (hex)	Subindex	Data Type	Access	Setting Range	Default Setting
E900h	4	UDINT	RO	00000000h to FFFFFFFFh	000A0192h

FSoE Info Data, FSoE Module Vendor ID

Index (hex)	Subindex	Data Type	Access	Setting Range	Default Setting
E900h	5	UDINT	RO	00000000h to FFFFFFFFh	00000539h (= Yaskawa)

FSoE Info Data, FSoE Module Product Code

Index (hex)	Subindex	Data Type	Access	Setting Range	Default Setting
E900h	6	UDINT	RO	00000000h to FFFFFFFFh	*1

*1: FSoE Module Product Code

Model name	Firmware version	Default Setting
SGD7S-OSB01A, SGD7S-OSB02A	v007	02200801h
	v008	02200802h

FSoE Info Data, FSoE Module Revision Number

Index (hex)	Subindex	Data Type	Access	Setting Range	Default Setting
E900h	7	UDINT	RO	00000000h to FFFFFFFFh	*1

*1: Bit 31 to bit 16 = Major version, bit 15 to bit 0 = minor version

FSoE Info Data, FSoE Module Serial Number

Index (hex)	Subindex	Data Type	Access	Setting Range	Default Setting
E900h	8	UDINT	RO	00000000h to FFFFFFFFh	00000000h

FSoE Communication Parameter, FSoE Version

Index (hex)	Subindex	Data Type	Access	Setting Range	Default Setting
E901h	1	STRING(2)	RO	0000h to FFFFh	–

FSoE Communication Parameter, Safety Address

Index (hex)	Subindex	Data Type	Access	Setting Range	Default Setting
E901h	2	UINT	RO	0000h to FFFFh	Depends on Pc070

FSoE Communication Parameter, FSoE Connection ID

Index (hex)	Subindex	Data Type	Access	Setting Range	Default Setting
E901h	3	UINT	RO	0000h to FFFFh	–

FSoE Communication Parameter, Watchdog Time

Index (hex)	Subindex	Data Type	Access	Setting Range	Setting Unit	Default Setting
E901h	4	UINT	RO	30 to 65534	ms	100

FSoE Communication Parameter, Connection Type

Index (hex)	Subindex	Data Type	Access	Setting Range	Default Setting
E901h	6	UINT	RO	0000h to FFFFh	0001h (= Slave)

FSoE Communication Parameter, Communication Parameter Length

Index (hex)	Subindex	Data Type	Access	Setting Range	Default Setting
E901h	7	UINT	RO	0000h to FFFFh	000Eh

FSoE Communication Parameter, Application Parameter Length

Index (hex)	Subindex	Data Type	Access	Setting Range	Default Setting
E901h	8	UINT	RO	0000h to FFFFh	0000h (No SRA)

FSoE Connection Diagnosis, Connection State

Index (hex)	Subindex	Data Type	Access	Setting Range	Default Setting
EA00h	1	UINT	RO	0000h to FFFFh <ul style="list-style-type: none"> ■ 0064h (100): Reset ■ 0065h (101): Session ■ 0066h (102): Connection ■ 0067h (103): Parameter ■ 0068h (104): Data ■ 0069h (105): Failsafe 	–

FSoE Connection Diagnosis, Connection Diagnosis

Index (hex)	Subindex	Data Type	Access	Setting Range	Default Setting
EA00h	2	UINT	RO	0000h to FFFFh Bit 0..3 <ul style="list-style-type: none"> ■ 0: No error ■ 1: Wrong command ■ 2: Unknown command ■ 3: Wrong Connection ID ■ 4: Wrong CRC ■ 5: Watchdog expired ■ 6: Wrong FSoE Address ■ 7: Wrong Data ■ 8: Wrong Communication Parameter Length ■ 9: Wrong Communication Parameter ■ 10: Wrong Application Parameter Length ■ 11: Wrong Application Parameter ■ 12: Invalid IO Address ■ 13: Invalid Session ID ■ 14: No FSoE Data exchange ■ 15: Data Exchange in Process ■ 16: No valid FSoE Message Received 	–

A.3.2 Process Data Objects

A.3.2.1 Tx Process Data

Tx Process Data

Index (hex)	Subindex	Parameter Name	Direct Link
5A00h	1 to 16	Virtual Input Actual Value, Virtual Input 0 to Virtual Input 15	↔ 'Virtual Input Actual Value, Virtual Input 0 to Virtual Input 15'...page 267
5A04h	1 to 4	Multi Monitor Demand Value (MPD), MPD 0 to MPD 3	↔ 'Multi Monitor Demand Value (MPD), MPD 0 to MPD 3'...page 267
5A09h	0	FSoE Error Ack	↔ 'FSoE Error Ack'...page 267

A.3.2.1.1 Detailed Parameter Description of Tx Process Data

These parameters are used to build up the PDO mapping defined in the FSoE chapter [↔ 'FSoE Parameters and Process Data'...page 178](#). With its parameter number they can also be read by SigmaWin+ and the Digital Operator.

Virtual Input Actual Value, Virtual Input 0 to Virtual Input 15

Index (hex)	Subindex	Data Type	Access	Setting Range	Setting Unit	Default Setting
5A00h	1	BOOL	RO	–	–	–
5A00h	2	BOOL	RO	–	–	–
5A00h	3	BOOL	RO	–	–	–
5A00h	4	BOOL	RO	–	–	–
5A00h	5	BOOL	RO	–	–	–
5A00h	6	BOOL	RO	–	–	–
5A00h	7	BOOL	RO	–	–	–
5A00h	8	BOOL	RO	–	–	–
5A00h	9	BOOL	RO	–	–	–
5A00h	10	BOOL	RO	–	–	–
5A00h	11	BOOL	RO	–	–	–
5A00h	12	BOOL	RO	–	–	–
5A00h	13	BOOL	RO	–	–	–
5A00h	14	BOOL	RO	–	–	–
5A00h	15	BOOL	RO	–	–	–
5A00h	16	BOOL	RO	–	–	–

Multi Monitor Demand Value (MPD), MPD 0 to MPD 3

Index (hex)	Subindex	Data Type	Access	Setting Range	Setting Unit	Default Setting
5A04h	1	BOOL	RO	FALSE, TRUE	–	FALSE
5A04h	2	BOOL	RO	FALSE, TRUE	–	FALSE
5A04h	3	BOOL	RO	FALSE, TRUE	–	FALSE
5A04h	4	BOOL	RO	FALSE, TRUE	–	FALSE

FSoE Error Ack

Index (hex)	Subindex	Data Type	Access	Setting Range	Setting Unit	Default Setting
5A09h	0	BOOL	RO	–	–	–

A.3.2.2 Rx Process Data

Rx Process Data

Index (hex)	Subindex	Parameter Name	Direct Link
5A01h	1 to 16	Virtual Output Actual Value, Virtual Output 0 to Virtual Output 15	↔ 'Virtual Output Actual Value, Virtual Output 0 to Virtual Output 15'...page 268

Index (hex)	Subindex	Parameter Name	Direct Link
5A02h	1 to 10	Safety Slot Status Actual Value, SF_1 to SF_10	↔ 'Safety Slot Status Actual Value, SF_1 to SF_10'...page 269
5A03h	1 to 14	I/O Terminal Actual Value, PIO_A1 to PIO_G2	↔ 'I/O Terminal Actual Value, PIO_A1 to PIO_G2'...page 269
5A05h	1 to 4	Multi Monitor Actual Value (MPA), MPA 0 to MPA 3	↔ 'Multi Monitor Actual Value (MPA), MPA 0 to MPA 3'...page 270
5A06h	1 to 2	Multi Monitor 1 Actual Value, Multi Monitor 1 Actual Value (1st word) to Multi Monitor 1 Actual Value (2nd word)	↔ 'Multi Monitor 1 Actual Value, Multi Monitor Actual Value (1st word) to Multi Monitor Actual Value (2nd word)'...page 270
5A07h	1 to 2	Multi Monitor 2 Actual Value, Multi Monitor 2 Actual Value (1st word) to Multi Monitor 2 Actual Value (2nd word)	↔ 'Multi Monitor 2 Actual Value, Multi Monitor Actual Value (1st word) to Multi Monitor Actual Value (2nd word)'...page 270
5A08h	0	FSoE Error	↔ 'FSoE Error'...page 270
5A0Bh	10	Safety Slot Actual Value 2, SHP Status	↔ 'Safety Slot Actual Value 2, SHP Status'...page 276

A.3.2.2.1 Detailed Parameter Description of Rx Process Data

These parameters are used to build up the PDO mapping defined in the FSoE chapter [↔ 'FSoE Parameters and Process Data'...page 178](#). With its parameter number they can also be read by SigmaWin+ and the Digital Operator.

Virtual Output Actual Value, Virtual Output 0 to Virtual Output 15

Index (hex)	Subindex	Data Type	Access	Setting Range	Setting Unit	Default Setting
5A01h	1	BOOL	RO	–	–	–
5A01h	2	BOOL	RO	–	–	–
5A01h	3	BOOL	RO	–	–	–
5A01h	4	BOOL	RO	–	–	–
5A01h	5	BOOL	RO	–	–	–
5A01h	6	BOOL	RO	–	–	–
5A01h	7	BOOL	RO	–	–	–
5A01h	8	BOOL	RO	–	–	–
5A01h	9	BOOL	RO	–	–	–
5A01h	10	BOOL	RO	–	–	–
5A01h	11	BOOL	RO	–	–	–
5A01h	12	BOOL	RO	–	–	–
5A01h	13	BOOL	RO	–	–	–
5A01h	14	BOOL	RO	–	–	–
5A01h	15	BOOL	RO	–	–	–
5A01h	16	BOOL	RO	–	–	–

Safety Slot Status Actual Value, SF_1 to SF_10

Index (hex)	Subindex	Data Type	Access	Setting Range	Setting Unit	Default Setting
5A02h	1	BOOL	RO	–	–	–
5A02h	2	BOOL	RO	–	–	–
5A02h	3	BOOL	RO	–	–	–
5A02h	4	BOOL	RO	–	–	–
5A02h	5	BOOL	RO	–	–	–
5A02h	6	BOOL	RO	–	–	–
5A02h	7	BOOL	RO	–	–	–
5A02h	8	BOOL	RO	–	–	–
5A02h	9	BOOL	RO	–	–	–
5A02h	10	BOOL	RO	–	–	–

I/O Terminal Actual Value, PIO_A1 to PIO_G2

Index (hex)	Subindex	Data Type	Access	Setting Range	Setting Unit	Default Setting
5A03h	1	BOOL	RO	–	–	–
5A03h	2	BOOL	RO	–	–	–
5A03h	3	BOOL	RO	–	–	–
5A03h	4	BOOL	RO	–	–	–
5A03h	5	BOOL	RO	–	–	–
5A03h	6	BOOL	RO	–	–	–
5A03h	7	BOOL	RO	–	–	–
5A03h	8	BOOL	RO	–	–	–
5A03h	9	BOOL	RO	–	–	–
5A03h	10	BOOL	RO	–	–	–
5A03h	11	BOOL	RO	–	–	–
5A03h	12	BOOL	RO	–	–	–
5A03h	13	BOOL	RO	–	–	–
5A03h	14	BOOL	RO	–	–	–



Not needed in SGD7S-OSB01: 0

FSoE Parameters > FSoE Device Information Objects

Multi Monitor Actual Value (MPA), MPA 0 to MPA 3

Index (hex)	Subindex	Data Type	Access	Setting Range	Setting Unit	Default Setting
5A05h	1	BOOL	RO	FALSE, TRUE	–	FALSE
5A05h	2	BOOL	RO	FALSE, TRUE	–	FALSE
5A05h	3	BOOL	RO	FALSE, TRUE	–	FALSE
5A05h	4	BOOL	RO	FALSE, TRUE	–	FALSE

Multi Monitor 1 Actual Value, Multi Monitor Actual Value (1st word) to Multi Monitor Actual Value (2nd word)

Index (hex)	Subindex	Data Type	Access	Setting Range	Setting Unit	Default Setting
5A06h	1	UINT	RO	–	–	–
5A06h	2	UINT	RO	–	–	–

Multi Monitor 2 Actual Value, Multi Monitor Actual Value (1st word) to Multi Monitor Actual Value (2nd word)

Index (hex)	Subindex	Data Type	Access	Setting Range	Setting Unit	Default Setting
5A07h	1	UINT	RO	–	–	–
5A07h	2	UINT	RO	–	–	–

FSoE Error

Index (hex)	Subindex	Data Type	Access	Setting Range	Setting Unit	Default Setting
5A08h	0	BOOL	RO	–	–	–

A.3.3 FSoE Device Information Objects**FSoE Device Information Objects**

Index (hex)	Subindex	Parameter Name	Direct Link
F000h	1	Modular Device Profile, Module Index Distance	↔ 'Modular Device Profile, Module Index Distance'...page 271
F000h	2	Modular Device Profile, Maximum Number of Modules	↔ 'Modular Device Profile, Maximum Number of Modules'...page 271
F010h	1	Module List, Module Profile List	↔ 'Module List, Module Profile List'...page 271
F050h	1	Detected Modules, Detected Module Ident List	↔ 'Detected Modules, Detected Module Ident List'...page 271
F980h	1	Device FSoE Slave Address (FSoE Address)	↔ 'FSoE Slave Address, FSoE Address'...page 271

A.3.3.1 Detailed Parameter Description of FSoE Device Information Objects

Modular Device Profile, Module Index Distance

Index (hex)	Subindex	Data Type	Access	Setting Range	Setting Unit	Default Setting
F000h	1	UINT	RO	0000h to 0800h	–	0010h

Modular Device Profile, Maximum Number of Modules

Index (hex)	Subindex	Data Type	Access	Setting Range	Setting Unit	Default Setting
F000h	2	UINT	RO	0001h to 0001h	–	0001h

Module List, Module Profile List

Index (hex)	Subindex	Data Type	Access	Setting Range	Setting Unit	Default Setting
F010h	1	UDINT	RO	00000000h to FFFFFFFFh	–	–

Detected Modules, Detected Module Ident List

Index (hex)	Subindex	Data Type	Access	Setting Range	Setting Unit	Default Setting
F050h	1	UDINT	RO	00000000h to FFFFFFFFh	–	–

FSoE Slave Address, FSoE Address

Index (hex)	Subindex	Data Type	Access	Setting Range	Setting Unit	Default Setting
F980h	1	UINT	RO	1 to 65535	–	1

A.4 Monitoring Parameters

Process Data Objects

Monitor No.	Index (hex)	Sub-index	Parameter Name	Direct Link
–	580Fh	1	SERVOPACK Safety Features	↪ 'SERVOPACK Safety Features'...page 273
–	580Fh	7	FSoE Alarm Code	↪ 'FSoE Alarm Code'...page 273
Un0AC	5A0Ah	1	Safety Slot Actual Value 1, Selected Slot Number	↪ 'Safety Slot Actual Value 1, Selected Slot Number'...page 273
Un0AD	5A0Ah	2	Safety Slot Actual Value 1, Actual Position Limit 1	↪ 'Safety Slot Actual Value 1, Actual Position Limit 1'...page 273
Un0AE	5A0Ah	3	Safety Slot Actual Value 1, Actual Position Limit 2	↪ 'Safety Slot Actual Value 1, Actual Position Limit 2'...page 274

Monitoring Parameters

Monitor No.	Index (hex)	Sub-index	Parameter Name	Direct Link
Un0AF	5A0Ah	4	Safety Slot Actual Value 1, Actual Speed Limit 1	↪ 'Safety Slot Actual Value 1, Actual Speed Limit 1'...page 274
Un0B0	5A0Ah	5	Safety Slot Actual Value 1, Actual Speed Limit 2	↪ 'Safety Slot Actual Value 1, Actual Speed Limit 2'...page 274
Un0B1	5A0Ah	6	Safety Slot Actual Value 1, Actual Acceleration Limit	↪ 'Safety Slot Actual Value 1, Actual Acceleration Limit'...page 274
Un0B2	5A0Ah	7	Safety Slot Actual Value 1, Actual Torque Limit	↪ 'Safety Slot Actual Value 1, Actual Torque Limit'...page 274
Un0B3	5A0Ah	8	Safety Slot Actual Value 1, Actual Temperature Limit	↪ 'Safety Slot Actual Value 1, Actual Temperature Limit'...page 274
Un0A3, Un0A4, Un0A5, Un0A6	5A0Bh	1	Safety Slot Actual Value 2, Safety Function Status for Slot 1 to 8	↪ 'Safety Slot Actual Value 2, Safety Function Status for Slot 1 to 8'...page 275
Un0A7	5A0Bh	2	Safety Slot Actual Value 2, Safety Function Status for Slot 9 to 10	↪ 'Safety Slot Actual Value 2, Safety Function Status for Slot 9 to 10'...page 275
Un0B6	5A0Bh	3	Safety Slot Actual Value 2, Actual Position (Monitoring)	↪ 'Safety Slot Actual Value 2, Actual Position (Monitoring)'...page 275
Un0B7	5A0Bh	4	Safety Slot Actual Value 2, Actual Position	↪ 'Safety Slot Actual Value 2, Actual Position'...page 275
Un0B8	5A0Bh	5	Safety Slot Actual Value 2, Actual Speed	↪ 'Safety Slot Actual Value 2, Actual Speed'...page 275
Un0B9	5A0Bh	6	Safety Slot Actual Value 2, Actual Acceleration	↪ 'Safety Slot Actual Value 2, Actual Acceleration'...page 275
Un0BA	5A0Bh	7	Safety Slot Actual Value 2, Actual Torque	↪ 'Safety Slot Actual Value 2, Actual Torque'...page 276
Un0BB	5A0Bh	8	Safety Slot Actual Value 2, Actual Temperature	↪ 'Safety Slot Actual Value 2, Actual Temperature'...page 276
Un0BD	5A0Bh	9	Safety Slot Actual Value 2, Actual Position Encoder 2	↪ 'Safety Slot Actual Value 2, Actual Position Encoder 2'...page 276
Un0C0	5A0Bh	10	Safety Slot Actual Value 2, SHP Status	↪ 'Safety Slot Actual Value 2, SHP Status'...page 276
Un0C1	5A0Bh	11	Safety Slot Actual Value 2, SHP Encoder Position	↪ 'Safety Slot Actual Value 2, SHP Encoder Position'...page 276
Un0C2	5A0Ch	1	Analog Input Actual Value, Port F1	↪ 'Analog Input Actual Value, Port F1'...page 277
Un0C3	5A0Ch	2	Analog Input Actual Value, Port F2	↪ 'Analog Input Actual Value, Port F2'...page 277
Un0C4	5A0Ch	3	Analog Input Actual Value, Port G1	↪ 'Analog Input Actual Value, Port G1'...page 277
Un0C5	5A0Ch	4	Analog Input Actual Value, Port G2	↪ 'Analog Input Actual Value, Port G2'...page 277

A.4.1 Detailed Parameter Description of Monitoring Parameters

SERVOPACK Safety Features

Monitor No.	Index (hex)	Subindex	Data Type	Access	Setting Range	Setting Unit	Default Setting
–	580Fh	1	UINT	RO	0000h to FFFFh	–	FFFFh

Digit	Name	Units R: Rotary L: Linear	Range	Default
0	HWBB	–	0: Standard HWBB feedback 1: Advanced HWBB feedback	0
1	Brake Control	–	0: Standard BC feedback 1: Advanced BC feedback	0
2	reserved			
3	reserved			

FSoE Alarm Code

Monitor No.	Index (hex)	Subindex	Data Type	Access	Setting Range	Setting Unit	Default Setting
–	580Fh	7	UINT	RO	0000h to FFFFh	–	0000h

Range	Size	Access
0000h: Local reset or reset command confirm 0001h: Invalid command 0002h: Unknown command 0003h: Wrong connection number 0004h: CRC error in received message 0005h: Watch Dog time expired 0006h: Invalid FSoE address 0007h: Invalid safe data 0008h: Invalid communication parameter length 0009h: Invalid communication parameter data 000Ah: Invalid application parameter length 000Bh: Invalid application parameter data	16 bit	RO

Safety Slot Actual Value 1, Selected Slot Number

Monitor No.	Index (hex)	Subindex	Data Type	Access	Setting Range	Setting Unit	Default Setting
Un0AC	5A0Ah	1	UINT	RO	–	–	–

Safety Slot Actual Value 1, Actual Position Limit 1

Monitor No.	Index (hex)	Subindex	Data Type	Access	Setting Range	Setting Unit	Default Setting
Un0AD	5A0Ah	2	DINT	RO	–	Pos. unit	–

Safety Slot Actual Value 1, Actual Position Limit 2

Monitor No.	Index (hex)	Subindex	Data Type	Access	Setting Range	Setting Unit	Default Setting
Un0AE	5A0Ah	3	DINT	RO	–	Pos. unit	–

Safety Slot Actual Value 1, Actual Speed Limit 1

Monitor No.	Index (hex)	Subindex	Data Type	Access	Setting Range	Setting Unit	Default Setting
Un0AF	5A0Ah	4	DINT	RO	–	Vel. unit	–

Safety Slot Actual Value 1, Actual Speed Limit 2

Monitor No.	Index (hex)	Subindex	Data Type	Access	Setting Range	Setting Unit	Default Setting
Un0B0	5A0Ah	5	DINT	RO	–	Vel. unit	–

Safety Slot Actual Value 1, Actual Acceleration Limit

Monitor No.	Index (hex)	Subindex	Data Type	Access	Setting Range	Setting Unit	Default Setting
Un0B1	5A0Ah	6	DINT	RO	–	Acc. unit	–

Safety Slot Actual Value 1, Actual Torque Limit

Monitor No.	Index (hex)	Subindex	Data Type	Access	Setting Range	Setting Unit	Default Setting
Un0B2	5A0Ah	7	INT	RO	–	*1	–

*1: Unit depends on the selected input port in the safety slot setting:

- Port F (0-10 V): 1 mV
- Port G1 (4-20 mA): 2 μ A

Safety Slot Actual Value 1, Actual Temperature Limit

Monitor No.	Index (hex)	Subindex	Data Type	Access	Setting Range	Setting Unit	Default Setting
Un0B3	5A0Ah	8	INT	RO	–	*1	–

*1: Unit depends on the selected input port in the safety slot setting:

- Port F (0-10 V): 5 mV
- Port G1 (4-20 mA): 10 μ A
- Port G2 (PT1000): 0.1 $^{\circ}$ C

Safety Slot Actual Value 2, Safety Function Status for Slot 1 to 8

Monitor No.	Index (hex)	Subindex	Data Type	Access	Setting Range	Setting Unit	Default Setting
Un0A3, Un0A4, Un0A5, Un0A6	5A0Bh	1	UDINT	RO	–	–	–

Safety Slot Actual Value 2, Safety Function Status for Slot 9 to 10

Monitor No.	Index (hex)	Subindex	Data Type	Access	Setting Range	Setting Unit	Default Setting
Un0A7	5A0Bh	2	UDINT	RO	–	–	–

Safety Slot Actual Value 2, Actual Position (Monitoring)

Monitor No.	Index (hex)	Subindex	Data Type	Access	Setting Range	Setting Unit	Default Setting
Un0B6	5A0Bh	3	DINT	RO	–	Pos. unit	–



Relative position after activating safety function

Safety Slot Actual Value 2, Actual Position

Monitor No.	Index (hex)	Subindex	Data Type	Access	Setting Range	Setting Unit	Default Setting
Un0B7	5A0Bh	4	DINT	RO	–	Pos. unit	–



Depends on encoder usage:

- *Incremental: Incremental position after power-on*
- *Single-turn or multi-turn absolute: Encoder position*

After completing SHP, relative position from SHP completed position

Safety Slot Actual Value 2, Actual Speed

Monitor No.	Index (hex)	Subindex	Data Type	Access	Setting Range	Setting Unit	Default Setting
Un0B8	5A0Bh	5	DINT	RO	–	Vel. unit	–

Safety Slot Actual Value 2, Actual Acceleration

Monitor No.	Index (hex)	Subindex	Data Type	Access	Setting Range	Setting Unit	Default Setting
Un0B9	5A0Bh	6	DINT	RO	–	Acc. unit	–

Safety Slot Actual Value 2, Actual Torque

Monitor No.	Index (hex)	Subindex	Data Type	Access	Setting Range	Setting Unit	Default Setting
Un0BA	5A0Bh	7	INT	RO	–	*1	–

*1: Unit depends on the selected input port in the safety slot setting:

- Port F (0-10 V): 1 mV
- Port G1 (4-20 mA): 2 μ A

Safety Slot Actual Value 2, Actual Temperature

Monitor No.	Index (hex)	Subindex	Data Type	Access	Setting Range	Setting Unit	Default Setting
Un0BB	5A0Bh	8	INT	RO	–	*1	–

*1: Unit depends on the selected input port in the safety slot setting:

- Port F (0-10 V): 5 mV
- Port G1 (4-20 mA): 10 μ A
- Port G2 (PT1000): 0.1 $^{\circ}$ C

Safety Slot Actual Value 2, Actual Position Encoder 2

Monitor No.	Index (hex)	Subindex	Data Type	Access	Setting Range	Setting Unit	Default Setting
Un0BD	5A0Bh	9	DINT	RO	–	Pos. unit	–

Safety Slot Actual Value 2, SHP Status

Monitor No.	Index (hex)	Subindex	Data Type	Access	Setting Range	Setting Unit	Default Setting
Un0C0	5A0Bh	10	BOOL	RO	0000h to 0001h	–	0000h



Bit 0: 0 = SHP is not completed, 1 = SHP is completed.

Safety Slot Actual Value 2, SHP Encoder Position

Monitor No.	Index (hex)	Subindex	Data Type	Access	Setting Range	Setting Unit	Default Setting
Un0C1	5A0Bh	11	DINT	RO	–	Pos. unit	–



SHP Encoder Position is the position of the encoder, i.e. SigmaWin+ monitors

- *Absolute Encoder Multiturn*
- *Absolute Encoder Pulse in Single Rotation*

converted to the selected [Pos. unit].

Other parameters like Home Offset are not considered.

Analog Input Actual Value, Port F1

Monitor No.	Index (hex)	Subindex	Data Type	Access	Setting Range	Setting Unit	Default Setting
Un0C2	5A0Ch	1	INT	RO	–	mV	–

Analog Input Actual Value, Port F2

Monitor No.	Index (hex)	Subindex	Data Type	Access	Setting Range	Setting Unit	Default Setting
Un0C3	5A0Ch	2	INT	RO	–	mV	–

Analog Input Actual Value, Port G1

Monitor No.	Index (hex)	Subindex	Data Type	Access	Setting Range	Setting Unit	Default Setting
Un0C4	5A0Ch	3	INT	RO	–	μA	–

Analog Input Actual Value, Port G2

Monitor No.	Index (hex)	Subindex	Data Type	Access	Setting Range	Setting Unit	Default Setting
Un0C5	5A0Ch	4	INT	RO	–	0.1 °C	–

B EtherCAT Object List

B.1 Module Information Objects

Modular device profile

Index (hex)	Sub-index	Name	Data Type	Access	PDO Mapping	Default Value	Lower Limit	Upper Limit
F000h	Modular device profile							
	0	Number of entries	USINT	RO	No	2	–	–
	1	Module index distance	UINT	RO	No	0010h	–	–
	2	Maximum number of modules	UINT	RO	No	1	–	–

Module List

Index (hex)	Sub-index	Name	Data Type	Access	PDO Mapping	Default Value	Lower Limit	Upper Limit
F010h	Module List							
	0	Number of entries	USINT	RO	No	1	–	–
	1	Module Profile List	UDINT	RO	No	790	–	–

Detected Modules

Index (hex)	Sub-index	Name	Data Type	Access	PDO Mapping	Default Value	Lower Limit	Upper Limit
F050h	Detected Modules							
	0	Number of entries	USINT	RO	No	1	–	–
	1	Detected Module Ident List	UDINT	RO	No	0 *1	00000000h	FFFFFFFFh

*1. Detected Module Ident List:

When the safety module is not attached to the SERVOPACK, the value is default.

When the safety module is attached to the SERVOPACK, the value is as follows:

Model name	Firmware version	Setting value
SGD7S-OSB01A, SGD7S-OSB02A	v007	02200801h
	v008	02200802h

Device FSoE Slave Address

Index (hex)	Sub-index	Name	Data Type	Access	PDO Mapping	Default Value	Lower Limit	Upper Limit
F980h	Device FSoE Slave Address							
	0	Number of entries	USINT	RO	No	1	–	–
	1	FSoE Address	UINT	RO	No	1	1	65535

B.2 EtherCAT Communication Objects

RxPDO Mapping of FSoE Slave

Index (hex)	Sub-index	Name	Data Type	Access	PDO Mapping	Default Value	Remark
1608h	RxPDO Mapping of FSoE Slave						

Index (hex)	Sub-index	Name	Data Type	Access	PDO Mapping	Default Value	Remark
	0	Number of entries	USINT	RO	No	27	–
	1	Mapping entry 1	UDINT	RO	No	E7000108h	FSoE Master Frame Elements, FSoE Master Command
	2	Mapping entry 2	UDINT	RO	No	5A000101h	Virtual Input Actual Value, Virtual Input 0
	3	Mapping entry 3	UDINT	RO	No	5A000201h	Virtual Input Actual Value, Virtual Input 1
	4	Mapping entry 4	UDINT	RO	No	5A000301h	Virtual Input Actual Value, Virtual Input 2
	5	Mapping entry 5	UDINT	RO	No	5A000401h	Virtual Input Actual Value, Virtual Input 3
	6	Mapping entry 6	UDINT	RO	No	5A000501h	Virtual Input Actual Value, Virtual Input 4
	7	Mapping entry 7	UDINT	RO	No	5A000601h	Virtual Input Actual Value, Virtual Input 5
	8	Mapping entry 8	UDINT	RO	No	5A000701h	Virtual Input Actual Value, Virtual Input 6
	9	Mapping entry 9	UDINT	RO	No	5A000801h	Virtual Input Actual Value, Virtual Input 7
	10	Mapping entry 10	UDINT	RO	No	5A000901h	Virtual Input Actual Value, Virtual Input 8
	11	Mapping entry 11	UDINT	RO	No	5A000A01h	Virtual Input Actual Value, Virtual Input 9
	12	Mapping entry 12	UDINT	RO	No	5A000B01h	Virtual Input Actual Value, Virtual Input 10
	13	Mapping entry 13	UDINT	RO	No	5A000C01h	Virtual Input Actual Value, Virtual Input 11
	14	Mapping entry 14	UDINT	RO	No	5A000D01h	Virtual Input Actual Value, Virtual Input 12
	15	Mapping entry 15	UDINT	RO	No	5A000E01h	Virtual Input Actual Value, Virtual Input 13
	16	Mapping entry 16	UDINT	RO	No	5A000F01h	Virtual Input Actual Value, Virtual Input 14
	17	Mapping entry 17	UDINT	RO	No	5A001001h	Virtual Input Actual Value, Virtual Input 15
	18	Mapping entry 18	UDINT	RO	No	E7000310h	FSoE Master Frame Elements, FSoE Master CRC_0
	19	Mapping entry 19	UDINT	RO	No	5A040101h	Multi Monitor Demand Value (MPD), MPD 0
	20	Mapping entry 20	UDINT	RO	No	5A040201h	Multi Monitor Demand Value (MPD), MPD 1
	21	Mapping entry 21	UDINT	RO	No	5A040301h	Multi Monitor Demand Value (MPD), MPD 2
	22	Mapping entry 22	UDINT	RO	No	5A040401h	Multi Monitor Demand Value (MPD), MPD 3
	23	Mapping entry 23	UDINT	RO	No	00000003h	Padding

EtherCAT Communication Objects

Index (hex)	Sub-index	Name	Data Type	Access	PDO Mapping	Default Value	Remark
	24	Mapping entry 24	UDINT	RO	No	5A090001h	FSoE Error Ack
	25	Mapping entry 25	UDINT	RO	No	00000008h	Padding
	26	Mapping entry 26	UDINT	RO	No	E7000410h	FSoE Master Frame Elements, FSoE Master CRC_1
	27	Mapping entry 27	UDINT	RO	No	E7000210h	FSoE Master Frame Elements, FSoE Master Connection ID
	28	Mapping entry 28	UDINT	RO	No	00000000h	not used
	29	Mapping entry 29	UDINT	RO	No	00000000h	not used
	30	Mapping entry 30	UDINT	RO	No	00000000h	not used
	31	Mapping entry 31	UDINT	RO	No	00000000h	not used
	32	Mapping entry 32	UDINT	RO	No	00000000h	not used

TxPDO Mapping of FSoE Slave

Index (hex)	Sub-index	Name	Data Type	Access	PDO Mapping	Default Value	Remark
1A08h	TxPDO Mapping of FSoE Slave						
	0	Number of entries	USINT	RO	No	60	–
	1	Mapping entry 1	UDINT	RO	No	E6000108h	FSoE Slave Frame Elements, FSoE Slave Command
	2	Mapping entry 2	UDINT	RO	No	5A010101h	Virtual Output Actual Value, Virtual Output 0
	3	Mapping entry 3	UDINT	RO	No	5A010201h	Virtual Output Actual Value, Virtual Output 1
	4	Mapping entry 4	UDINT	RO	No	5A010301h	Virtual Output Actual Value, Virtual Output 2
	5	Mapping entry 5	UDINT	RO	No	5A010401h	Virtual Output Actual Value, Virtual Output 3
	6	Mapping entry 6	UDINT	RO	No	5A010501h	Virtual Output Actual Value, Virtual Output 4
	7	Mapping entry 7	UDINT	RO	No	5A010601h	Virtual Output Actual Value, Virtual Output 5
	8	Mapping entry 8	UDINT	RO	No	5A010701h	Virtual Output Actual Value, Virtual Output 6
	9	Mapping entry 9	UDINT	RO	No	5A010801h	Virtual Output Actual Value, Virtual Output 7
	10	Mapping entry 10	UDINT	RO	No	5A010901h	Virtual Output Actual Value, Virtual Output 8
	11	Mapping entry 11	UDINT	RO	No	5A010A01h	Virtual Output Actual Value, Virtual Output 9
	12	Mapping entry 12	UDINT	RO	No	5A010B01h	Virtual Output Actual Value, Virtual Output 10
	13	Mapping entry 13	UDINT	RO	No	5A010C01h	Virtual Output Actual Value, Virtual Output 11

Index (hex)	Sub-index	Name	Data Type	Access	PDO Mapping	Default Value	Remark
	14	Mapping entry 14	UDINT	RO	No	5A010D01h	Virtual Output Actual Value, Virtual Output 12
	15	Mapping entry 15	UDINT	RO	No	5A010E01h	Virtual Output Actual Value, Virtual Output 13
	16	Mapping entry 16	UDINT	RO	No	5A010F01h	Virtual Output Actual Value, Virtual Output 14
	17	Mapping entry 17	UDINT	RO	No	5A011001h	Virtual Output Actual Value, Virtual Output 15
	18	Mapping entry 18	UDINT	RO	No	E6000310h	FSoE Slave Frame Elements, FSoE Slave CRC_0
	19	Mapping entry 19	UDINT	RO	No	5A020101h	Slot Status Actual Value, SF_1
	20	Mapping entry 20	UDINT	RO	No	5A020201h	Slot Status Actual Value, SF_2
	21	Mapping entry 21	UDINT	RO	No	5A020301h	Slot Status Actual Value, SF_3
	22	Mapping entry 22	UDINT	RO	No	5A020401h	Slot Status Actual Value, SF_4
	23	Mapping entry 23	UDINT	RO	No	5A020501h	Slot Status Actual Value, SF_5
	24	Mapping entry 24	UDINT	RO	No	5A020601h	Slot Status Actual Value, SF_6
	25	Mapping entry 25	UDINT	RO	No	5A020701h	Slot Status Actual Value, SF_7
	26	Mapping entry 26	UDINT	RO	No	5A020801h	Slot Status Actual Value, SF_8
	27	Mapping entry 27	UDINT	RO	No	5A020901h	Slot Status Actual Value, SF_9
	28	Mapping entry 28	UDINT	RO	No	5A020A01h	Slot Status Actual Value, SF_10
	29	Mapping entry 29	UDINT	RO	No	5A030101h	I/O Terminal Actual Value, PIO_A1
	30	Mapping entry 30	UDINT	RO	No	5A030201h	I/O Terminal Actual Value, PIO_A2
	31	Mapping entry 31	UDINT	RO	No	5A030301h	I/O Terminal Actual Value, PIO_B1
	32	Mapping entry 32	UDINT	RO	No	5A030401h	I/O Terminal Actual Value, PIO_B2
	33	Mapping entry 33	UDINT	RO	No	5A030501h	I/O Terminal Actual Value, PIO_C1
	34	Mapping entry 34	UDINT	RO	No	5A030601h	I/O Terminal Actual Value, PIO_C2
	35	Mapping entry 35	UDINT	RO	No	E6000410h	FSoE Slave Frame Elements, FSoE Slave CRC_1
	36	Mapping entry 36	UDINT	RO	No	5A030701h	I/O Terminal Actual Value, PIO_D1
	37	Mapping entry 37	UDINT	RO	No	5A030801h	I/O Terminal Actual Value, PIO_D2
	38	Mapping entry 38	UDINT	RO	No	5A030901h	I/O Terminal Actual Value, PIO_E1
	39	Mapping entry 39	UDINT	RO	No	5A030A01h	I/O Terminal Actual Value, PIO_E2
	40	Mapping entry 40	UDINT	RO	No	5A030B01h	I/O Terminal Actual Value, PIO_F1
	41	Mapping entry 41	UDINT	RO	No	5A030C01h	I/O Terminal Actual Value, PIO_F2
	42	Mapping entry 42	UDINT	RO	No	5A030D01h	I/O Terminal Actual Value, PIO_G1
	43	Mapping entry 43	UDINT	RO	No	5A030E01h	I/O Terminal Actual Value, PIO_G2
	44	Mapping entry 44	UDINT	RO	No	5A050101h	Multi Monitor Actual Value (MPA), MPA 0
	45	Mapping entry 45	UDINT	RO	No	5A050201h	Multi Monitor Actual Value (MPA), MPA 1

EtherCAT Communication Objects

Index (hex)	Sub-index	Name	Data Type	Access	PDO Mapping	Default Value	Remark
	46	Mapping entry 46	UDINT	RO	No	5A050301h	Multi Monitor Actual Value (MPA), MPA 2
	47	Mapping entry 47	UDINT	RO	No	5A050401h	Multi Monitor Actual Value (MPA), MPA 3
	48	Mapping entry 48	UDINT	RO	No	00000002h	Padding
	49	Mapping entry 49	UDINT	RO	No	5A0B0A01h	Safety Slot Actual Value 2, SHP Status
	50	Mapping entry 50	UDINT	RO	No	5A080001h	FSoE Error
	51	Mapping entry 51	UDINT	RO	No	E6000510h	FSoE Slave Frame Elements, FSoE Slave CRC_2
	52	Mapping entry 52	UDINT	RO	No	5A060110h	Multi Monitor 1 Actual Value, Multi Monitor 1 Actual Value (1st word)
	53	Mapping entry 53	UDINT	RO	No	E6000610h	FSoE Slave Frame Elements, FSoE Slave CRC_3
	54	Mapping entry 54	UDINT	RO	No	5A060210h	Multi Monitor 1 Actual Value, Multi Monitor 1 Actual Value (2nd word)
	55	Mapping entry 55	UDINT	RO	No	E6000710h	FSoE Slave Frame Elements, FSoE Slave CRC_4
	56	Mapping entry 56	UDINT	RO	No	5A070110h	Multi Monitor 2 Actual Value, Multi Monitor 2 Actual Value (1st word)
	57	Mapping entry 57	UDINT	RO	No	E6000810h	FSoE Slave Frame Elements, FSoE Slave CRC_5
	58	Mapping entry 58	UDINT	RO	No	5A070210h	Multi Monitor 2 Actual Value, Multi Monitor 2 Actual Value (2nd word)
	59	Mapping entry 59	UDINT	RO	No	E6000910h	FSoE Slave Frame Elements, FSoE Slave CRC_6
	60	Mapping entry 60	UDINT	RO	No	E6000210h	FSoE Slave Frame Elements, FSoE Slave Connection ID
	61	Mapping entry 61	UDINT	RO	No	00000000h	not used
	62	Mapping entry 62	UDINT	RO	No	00000000h	not used
	63	Mapping entry 63	UDINT	RO	No	00000000h	not used
	64	Mapping entry 64	UDINT	RO	No	00000000h	not used

FSoE Connection Parameter Set Mapping

Index (hex)	Sub-index	Name	Data Type	Access	PDO Mapping	Default Value	Remark
1E00h		FSoE Connection Parameter Set Mapping					
	0	Number of entries	USINT	RO	No	3	–
	1	Mapping entry 1	UDINT	RO	No	E9010710h	Communication Parameter Length
	2	Mapping entry 2	UDINT	RO	No	E9010410h	Watchdog Time
	3	Mapping entry 3	UDINT	RO	No	E9010810h	Application Parameter Length

FSoE Slave Frame Elements

Index (hex)	Sub-index	Name	Data Type	Access	PDO Mapping *3	Default Value	Remark
E600h	FSoE Slave Frame Elements						
	0	Number of entries	USINT	RO	No	10	–
	1	FSoE Slave Command	USINT	RO	TxPDO	–	–
	2	FSoE Slave Connection ID	UINT	RO	TxPDO	–	–
	3	FSoE Slave CRC_0	UINT	RO	TxPDO	–	–
	4	FSoE Slave CRC_1	UINT	RO	TxPDO	–	–
	5	FSoE Slave CRC_2	UINT	RO	TxPDO	–	–
	6	FSoE Slave CRC_3	UINT	RO	TxPDO	–	–
	7	FSoE Slave CRC_4	UINT	RO	TxPDO	–	–
	8	FSoE Slave CRC_5	UINT	RO	TxPDO	–	–
	9	FSoE Slave CRC_6	UINT	RO	TxPDO	–	–
	10	FSoE Slave CRC_7	UINT	RO	TxPDO	–	–

*3: RxPDO: Master Output (Master to Slave) - TxPDO: Master Input (Slave to Master)

FSoE Master Frame Elements

Index (hex)	Sub-index	Name	Data Type	Access	PDO Mapping *3	Default Value	Remark
E700h	FSoE Master Frame Elements						
	0	Number of entries	USINT	RO	No	10	–
	1	FSoE Master Command	USINT	RO	RxPDO	–	–
	2	FSoE Master Connection ID	UINT	RO	RxPDO	–	–
	3	FSoE Master CRC_0	UINT	RO	RxPDO	–	–
	4	FSoE Master CRC_1	UINT	RO	RxPDO	–	–
	5	FSoE Master CRC_2	UINT	RO	RxPDO	–	–
	6	FSoE Master CRC_3	UINT	RO	RxPDO	–	–

EtherCAT Communication Objects

Index (hex)	Sub-index	Name	Data Type	Access	PDO Mapping *3	Default Value	Remark
	7	FSoE Master CRC_4	UINT	RO	RxPDO	–	–
	8	FSoE Master CRC_5	UINT	RO	RxPDO	–	–
	9	FSoE Master CRC_6	UINT	RO	RxPDO	–	–
	10	FSoE Master CRC_7	UINT	RO	RxPDO	–	–

*3: RxPDO: Master Output (Master to Slave) - TxPDO: Master Input (Slave to Master)

FSoE Info Data

Index (hex)	Sub-index	Name	Data Type	Access	PDO Mapping	Default Value	Remark
E900h	FSoE Info Data						
	0	Number of entries	USINT	RO	No	8	–
	1	FSoE Module Connection ID	UINT	RO	No	–	–
	2	FSoE Module Type	STRING(4)	RO	No	*1	–
	3	FSoE Module Name	STRING(24)	RO	No	*1	–
	4	FSoE Module Device Type	UDINT	RO	No	000A0192h	–
	5	FSoE Module Vendor ID	UDINT	RO	No	00000539h	–
	6	FSoE Module Product Code	UDINT	RO	No	*2	–
	7	FSoE Module Revision Number	UDINT	RO	No	*3	–
	8	FSoE Module Serial Number	UDINT	RO	No	0	Not used, it is always 0.

*1: FSoE Module Name

Model name	E900.2h FSoE Module Type	Setting value
SGD7S-OSB01A	0B01	SGD7S-OSB01A
SGD7S-OSB02A	0B02	SGD7S-OSB02A

*2: FSoE Module Product Code

Model name	Firmware version	Setting value
SGD7S-OSB01A, SGD7S-OSB02A	v007	02200801h
	v008	02200802h

***3: FSoE Module Revision Number**

Model name	Firmware version	Setting value
SGD7S-OSB01A, SGD7S-OSB02A	v007	00070000h
	v008	00080000h

Bit 31 to bit 16 = Major version, bit 15 to bit 0 = minor version

FSoE Communication Parameter

Index (hex)	Sub-index	Name	Data Type	Access	PDO Mapping	Default Value	Remark
E901h	FSoE Communication Parameter						
	0	Number of entries	USINT	RO	No	8	–
	1	FSoE Version	STRING(2)	RO	No	–	–
	2	Safety Address	UINT	RO	No	–	–
	3	FSoE Connection ID	UINT	RO	No	–	–
	4	Watchdog Time	UINT	RO	No	–	–
	6	Connection Type	UINT	RO	No	0001h	Slave Connection
	7	Communication Parameter Length	UINT	RO	No	4	–
	8	Application Parameter Length	UINT	RO	No	0	–

FSoE Connection Diagnosis

Index (hex)	Sub-index	Name	Data Type	Access	PDO Mapping	Default Value	Remark
EA00h	FSoE Connection Diagnosis						
	0	Number of entries	USINT	RO	No	2	–
	1	Connection State	UINT	RO	No	–	–
	2	Connection Diagnosis	UINT	RO	No	–	–

B.3 Application Objects**Safety Related Servo Parameters**

Index (hex)	Sub-index	Name	Data Type	Access	PDO Mapping	Default Value	Lower Limit	Upper Limit	Unit	Parameter No.
5800h	Safety Related Servo Parameters									
	0	Number of entries	USINT	RO	No	16	–	–	–	–
	1	Motor Setting Switch	UINT	RO	No	0000h	0000h	0011h	–	Pc050

Application Objects

Index (hex)	Sub-index	Name	Data Type	Access	PDO Mapping	Default Value	Lower Limit	Upper Limit	Unit	Parameter No.
	2	Function Setting Switch	UINT	RO	No	0000h	0000h	0001h	–	Pc051
	3	External Encoder Setting Switch	UINT	RO	No	0000h	0000h	0012h	–	Pc05A
	4	Encoder Number of Pulses (External Encoder)	UDINT	RO	No	0	0	16777216	pulse/rev	Pc05C
	5	Encoder Data Format Configuration 1 (Motor Encoder)	UINT	RO	No	24	0	32	Bit	Pc060
	6	Motor Max.Speed (Motor Encoder)	UINT	RO	No	003Ch	0000h	FFFFh	–	Pc062
	7	Linear Scale Pitch, Mantissa (Motor Encoder)	UDINT	RO	No	0	0	16777216	fm	Pc063
	8	Linear Scale Pitch, Exponent and Linear Encoder Resolution (Motor Encoder)	UINT	RO	No	0	0	FFFFh	–	Pc065
	9	Encoder Number of Pulses (Motor Encoder)	UDINT	RO	No	0	0	1073741824	pulse/rev	Pc066
	10	Encoder Information (Motor Encoder)	UINT	RO	No	0000h	0000h	2111h	–	Pc068
	11	Encoder Data Format Configuration 2 (Motor Encoder)	UINT	RO	No	0000h	0000h	FFFFh	–	Pc069
	12	Multiturn Limit	UINT	RO	No	65535	0	65535	Rev	Pc06A
	13	Encoder Information (External Encoder)	UINT	RO	No	0000h	0000h	1111h	–	Pc06B

Index (hex)	Sub-index	Name	Data Type	Access	PDO Mapping	Default Value	Lower Limit	Upper Limit	Unit	Parameter No.
	14	Encoder Data Format Configuration 2 (External Encoder)	UINT	RO	No	0000h	0000h	FFFFh	–	Pc06C
	15	Linear Scale Pitch, Mantissa (External Encoder)	UDINT	RO	No	0	0	16777216	fm	Pc06D
	16	Linear Scale Pitch, Exponent and Linear Encoder Resolution (External Encoder)	UINT	RO	No	0	0	FFFFh	–	Pc06F

FSoE Hardware Address

Index (hex)	Sub-index	Name	Data Type	Access	PDO Mapping	Default Value	Lower Limit	Upper Limit	Unit	Parameter No.
5801h	0	FSoE Hardware Address	UINT	RO	No	0001h	0001h	FFFFh	–	Pc070

Numerator Position User Units Encoder 1

Index (hex)	Sub-index	Name	Data Type	Access	PDO Mapping	Default Value	Lower Limit	Upper Limit	Unit	Parameter No.
5802h	0	Numerator Position User Units Encoder 1	UDINT	RO	No	1	1	1073741824	–	Pc072

Denominator Position User Units Encoder 1

Index (hex)	Sub-index	Name	Data Type	Access	PDO Mapping	Default Value	Lower Limit	Upper Limit	Unit	Parameter No.
5803h	0	Denominator Position User Units Encoder 1	UDINT	RO	No	1	1	1073741824	–	Pc074

Application Objects

Numerator Position User Units Encoder 2

Index (hex)	Sub-index	Name	Data Type	Access	PDO Mapping	Default Value	Lower Limit	Upper Limit	Unit	Parameter No.
5804h	0	Numerator Position User Units Encoder 2	UDINT	RO	No	1	1	1073741824	–	Pc076

Denominator Position User Units Encoder 2

Index (hex)	Sub-index	Name	Data Type	Access	PDO Mapping	Default Value	Lower Limit	Upper Limit	Unit	Parameter No.
5805h	0	Denominator Position User Units Encoder 2	UDINT	RO	No	1	1	1073741824	–	Pc078

Numerator Velocity User Units Encoder 1

Index (hex)	Sub-index	Name	Data Type	Access	PDO Mapping	Default Value	Lower Limit	Upper Limit	Unit	Parameter No.
5806h	0	Numerator Velocity User Units Encoder 1	UDINT	RO	No	1	1	1073741824	–	Pc07A

Denominator Velocity User Units Encoder 1

Index (hex)	Sub-index	Name	Data Type	Access	PDO Mapping	Default Value	Lower Limit	Upper Limit	Unit	Parameter No.
5807h	0	Denominator Velocity User Units Encoder 1	UDINT	RO	No	1	1	1073741824	–	Pc07C

Numerator Velocity User Units Encoder 2

Index (hex)	Sub-index	Name	Data Type	Access	PDO Mapping	Default Value	Lower Limit	Upper Limit	Unit	Parameter No.
5808h	0	Numerator Velocity User Units Encoder 2	UDINT	RO	No	1	1	1073741824	–	Pc07E

Denominator Velocity User Units Encoder 2

Index (hex)	Sub-index	Name	Data Type	Access	PDO Mapping	Default Value	Lower Limit	Upper Limit	Unit	Parameter No.
5809h	0	Denominator Velocity User Units Encoder 2	UDINT	RO	No	1	1	1073741824	–	Pc080

Numerator Acceleration User Units Encoder 1

Index (hex)	Sub-index	Name	Data Type	Access	PDO Mapping	Default Value	Lower Limit	Upper Limit	Unit	Parameter No.
580Ah	0	Numerator Acceleration User Units Encoder 1	UDINT	RO	No	1	1	1073741824	–	Pc082

Denominator Acceleration User Units Encoder 1

Index (hex)	Sub-index	Name	Data Type	Access	PDO Mapping	Default Value	Lower Limit	Upper Limit	Unit	Parameter No.
580Bh	0	Denominator Acceleration User Units Encoder 1	UDINT	RO	No	1	1	1073741824	–	Pc084

Numerator Acceleration User Units Encoder 2

Index (hex)	Sub-index	Name	Data Type	Access	PDO Mapping	Default Value	Lower Limit	Upper Limit	Unit	Parameter No.
580Ch	0	Numerator Acceleration User Units Encoder 2	UDINT	RO	No	1	1	1073741824	–	Pc086

Denominator Acceleration User Units Encoder 2

Index (hex)	Sub-index	Name	Data Type	Access	PDO Mapping	Default Value	Lower Limit	Upper Limit	Unit	Parameter No.
580Dh	0	Denominator Acceleration User Units Encoder 2	UDINT	RO	No	1	1	1073741824	–	Pc088

Application Objects

User Units

Index (hex)	Sub-index	Name	Data Type	Access	PDO Mapping	Default Value	Lower Limit	Upper Limit	Unit	Parameter No.
580Eh	User Units									
	0	Number of entries	USINT	RO	No	16	–	–	–	–
	1	User Units (Position)	STRING (8)	RO	No	0	0	–	–	Pc08A to Pc08D
	2	User Units (Velocity)	STRING (8)	RO	No	0	0	–	–	Pc08E to Pc091
	3	User Units (Acceleration)	STRING (8)	RO	No	0	0	–	–	Pc092 to Pc095
	4	Reserved	UINT	RO	No	0000h	–	–	–	–
	5	Encoder Deviation	UDINT	RO	No	0	0	4294967295	Increments	Pc097
	6	Encoder Deviation Window	UDINT	RO	No	0	0	4294967295	1 ms	Pc099
	7	Encoder Absolute Position Difference E1 to E2	DINT	RO	No	0	-2147483648	2147483647	Pos. unit	Pc09A
	8	Encoder Offset E1 to Homing Position (Origin)	DINT	RO	No	0	-2147483648	2147483647	Pos. unit	Pc09C
	9	Limit Violation Deactivation Delay Time (LVDDT)	UINT	RO	No	0	0	10000	1 ms	Pc09E

SERVOPACK Features

Index (hex)	Sub-index	Name	Data Type	Access	PDO Mapping	Default Value	Lower Limit	Upper Limit	Unit	Parameter No.
580Fh	SERVOPACK Features									
	0	Number of entries	USINT	RO	No	7	–	–	–	–
	1	SERVOPACK Safety Features	UINT	RO	No	0000h	0000h	FFFFh	–	–
	2	Brake Reference - Servo OFF Delay Time	UINT	RO	No	0	0	50	10 ms	–

Index (hex)	Sub-index	Name	Data Type	Access	PDO Mapping	Default Value	Lower Limit	Upper Limit	Unit	Parameter No.
	3	Brake Reference Output Speed Level (rotary servo motor)	UINT	RO	No	0	100	10000	1 rpm	–
	4	Servo OFF - Brake Reference Waiting Time	UINT	RO	No	10	50	100	10 ms	–
	5	Brake Reference Output Speed Level (linear servo motor)	UINT	RO	No	0	10	10000	1 mm/s	–
	6	Built-in Brake Relay Usage Selection	UINT	RO	No	0000h	0000h	0001h	–	–
	7	FSoE Alarm Code	UINT	RO	No	0000h	0000h	FFFFh	–	–

Safe Port A Parameters

Index (hex)	Sub-index	Name	Data Type	Access	PDO Mapping	Default Value	Lower Limit	Upper Limit	Unit	Parameter No.
5810h	Safe Port A Parameters									
	0	Number of entries	USINT	RO	No	4	–	–	–	–
	1	Configuration	UINT	RO	No	0000h	0000h	000Bh	–	Pc0C0
	2	Filter Time	UINT	RO	No	0	0	4000	250 μ s	Pc0C1
	3	Discrepancy Time	UINT	RO	No	0	10	1000	1 ms	Pc0C2
	4	Test Pulse Length	UINT	RO	No	0	0	10000	0.1 ms	Pc0C3

Safe Port B Parameters

Index (hex)	Sub-index	Name	Data Type	Access	PDO Mapping	Default Value	Lower Limit	Upper Limit	Unit	Parameter No.
5820h	Safe Port B Parameters									
	0	Number of entries	USINT	RO	No	4	–	–	–	–
	1	Configuration	UINT	RO	No	0000h	0000h	000Bh	–	Pc0C8

Application Objects

Index (hex)	Sub-index	Name	Data Type	Access	PDO Mapping	Default Value	Lower Limit	Upper Limit	Unit	Parameter No.
	2	Filter Time	UINT	RO	No	0	0	4000	250 μ s	Pc0C9
	3	Discrepancy Time	UINT	RO	No	0	10	1000	1 ms	Pc0CA
	4	Test Pulse Length	UINT	RO	No	0	0	10000	0.1 ms	Pc0CB

Safe Port C Parameters

Index (hex)	Sub-index	Name	Data Type	Access	PDO Mapping	Default Value	Lower Limit	Upper Limit	Unit	Parameter No.
5830h	Safe Port C Parameters									
	0	Number of entries	USINT	RO	No	4	–	–	–	–
	1	Configuration	UINT	RO	No	0000h	0000h	000Bh	–	Pc0D0
	2	Filter Time	UINT	RO	No	0	0	4000	250 μ s	Pc0D1
	3	Discrepancy Time	UINT	RO	No	0	10	1000	1 ms	Pc0D2
	4	Test Pulse Length	UINT	RO	No	0	0	10000	0.1 ms	Pc0D3

Safe Port D Parameters

Index (hex)	Sub-index	Name	Data Type	Access	PDO Mapping	Default Value	Lower Limit	Upper Limit	Unit	Parameter No.
5840h	Safe Port D Parameters									
	0	Number of entries	USINT	RO	No	4	–	–	–	–
	1	Configuration	UINT	RO	No	0000h	0000h	000Bh	–	Pc0D8
	2	Filter Time	UINT	RO	No	0	0	4000	250 μ s	Pc0D9
	3	Discrepancy Time	UINT	RO	No	0	10	1000	1 ms	Pc0DA
	4	Test Pulse Length	UINT	RO	No	0	0	10000	0.1 ms	Pc0DB

Safe Port E Parameters

Index (hex)	Sub-index	Name	Data Type	Access	PDO Mapping	Default Value	Lower Limit	Upper Limit	Unit	Parameter No.
5850h	Safe Port E Parameters									
	0	Number of entries	USINT	RO	No	3	–	–	–	–

Index (hex)	Sub-index	Name	Data Type	Access	PDO Mapping	Default Value	Lower Limit	Upper Limit	Unit	Parameter No.
	1	Configuration	UINT	RO	No	0000h	0000h	000Bh	–	Pc0E0
	2	Filter Time	UINT	RO	No	0	0	4000	250 µs	Pc0E1
	3	Discrepancy Time	UINT	RO	No	0	10	1000	1 ms	Pc0E2

Safe Port F Parameters

Index (hex)	Sub-index	Name	Data Type	Access	PDO Mapping	Default Value	Lower Limit	Upper Limit	Unit	Parameter No.
5860h	Safe Port F Parameters									
	0	Number of entries	USINT	RO	No	4	–	–	–	–
	1	Configuration	UINT	RO	No	0000h	0000h	000Bh	–	Pc0E8
	2	Filter Time	UINT	RO	No	0	0	4000	250 µs	Pc0E9
	3	Discrepancy Time	UINT	RO	No	0	10	1000	1 ms	Pc0EA
	4	Channel Tolerance	UINT	RO	No	0	0	1000	0.001	Pc0EC

Port G Parameters

Index (hex)	Sub-index	Name	Data Type	Access	PDO Mapping	Default Value	Lower Limit	Upper Limit	Unit	Parameter No.
5870h	Port G Parameters									
	0	Number of entries	USINT	RO	No	1	–	–	–	–
	1	Configuration	UINT	RO	No	0000h	0000h	000Bh	–	Pc0F0

Slot 1 Parameters

Index (hex)	Sub-index	Name	Data Type	Access	PDO Mapping	Default Value	Lower Limit	Upper Limit	Unit	Parameter No.
5910h	Slot 1 Parameters									
	0	Number of entries	USINT	RO	No	13	–	–	–	–
	1	Configuration I	UINT	RO	No	0000h	0000h	4B12h	–	Pc300
	2	Configuration II	UINT	RO	No	0000h	0000h	2F39h	–	Pc301

Application Objects

Index (hex)	Sub-index	Name	Data Type	Access	PDO Mapping	Default Value	Lower Limit	Upper Limit	Unit	Parameter No.
	3	Waiting Time (t1)	UINT	RO	No	0	0	10000	10 ms	Pc310
	4	Monitoring Time (t2)	UINT	RO	No	0	0	10000	10 ms	Pc311
	5	Speed Limit (s1)	UDINT	RO	No	0	0	10000	Vel. unit	Pc312
	6	Speed Limit (s2)	UDINT	RO	No	0	0	10000	Vel. unit	Pc314
	7	Acceleration Limit (a1)	DINT	RO	No	0	-10000	10000	Acc. unit	Pc316
	8	Distance Limit (p1)	DINT	RO	No	0	-2147483648	2147483647	Pos. unit	Pc318
	9	Distance Limit (p2)	DINT	RO	No	0	-2147483648	2147483647	Pos. unit	Pc31A
	10	Distance Limit (p3)	UDINT	RO	No	0	0	4294967295	Pos. unit	Pc31C
	11	Torque Limit (tq1)	UINT	RO	No	0	0	10000	*1	Pc31E
	12	Temperature Limit (tp1)	UINT	RO	No	0	0	2000	*2	Pc31F
	13	Temperature Limit (tp2)	UINT	RO	No	0	0	2000	*2	Pc320

*1: Unit depends on the selected input port in the safety slot setting:

- Port F (0-10 V): 1 mV
- Port G1 (4-20 mA): 2 μ A

*2: Unit depends on the selected input port in the safety slot setting:

- Port F (0-10 V): 5 mV
- Port G1 (4-20 mA): 10 μ A
- Port G2 (PT1000): 0.1 $^{\circ}$ C

Slot 2 Parameters

Index (hex)	Sub-index	Name	Data Type	Access	PDO Mapping	Default Value	Lower Limit	Upper Limit	Unit	Parameter No.
5920h	Slot 2 Parameters									
	0	Number of entries	USINT	RO	No	13	–	–	–	–
	1	Configuration I	UINT	RO	No	0000h	0000h	4B12h	–	Pc380
	2	Configuration II	UINT	RO	No	0000h	0000h	2F39h	–	Pc381
	3	Waiting Time (t1)	UINT	RO	No	0	0	10000	10 ms	Pc390

Index (hex)	Sub-index	Name	Data Type	Access	PDO Mapping	Default Value	Lower Limit	Upper Limit	Unit	Parameter No.
	4	Monitoring Time (t2)	UINT	RO	No	0	0	10000	10 ms	Pc391
	5	Speed Limit (s1)	UDINT	RO	No	0	0	10000	Vel. unit	Pc392
	6	Speed Limit (s2)	UDINT	RO	No	0	0	10000	Vel. unit	Pc394
	7	Acceleration Limit (a1)	DINT	RO	No	0	-10000	10000	Acc. unit	Pc396
	8	Distance Limit (p1)	DINT	RO	No	0	-2147483648	2147483647	Pos. unit	Pc398
	9	Distance Limit (p2)	DINT	RO	No	0	-2147483648	2147483647	Pos. unit	Pc39A
	10	Distance Limit (p3)	UDINT	RO	No	0	0	4294967295	Pos. unit	Pc39C
	11	Torque Limit (tq1)	UINT	RO	No	0	0	10000	*1	Pc39E
	12	Temperature Limit (tp1)	UINT	RO	No	0	0	2000	*2	Pc39F
	13	Temperature Limit (tp2)	UINT	RO	No	0	0	2000	*2	Pc3A0

*1: Unit depends on the selected input port in the safety slot setting:

- Port F (0-10 V): 1 mV
- Port G1 (4-20 mA): 2 μ A

*2: Unit depends on the selected input port in the safety slot setting:

- Port F (0-10 V): 5 mV
- Port G1 (4-20 mA): 10 μ A
- Port G2 (PT1000): 0.1 $^{\circ}$ C

Slot 3 Parameters

Index (hex)	Sub-index	Name	Data Type	Access	PDO Mapping	Default Value	Lower Limit	Upper Limit	Unit	Parameter No.
5930h	Slot 3 Parameters									
	0	Number of entries	USINT	RO	No	13	–	–	–	–
	1	Configuration I	UINT	RO	No	0000h	0000h	4B12h	–	Pc400
	2	Configuration II	UINT	RO	No	0000h	0000h	2F39h	–	Pc401
	3	Waiting Time (t1)	UINT	RO	No	0	0	10000	10 ms	Pc410
	4	Monitoring Time (t2)	UINT	RO	No	0	0	10000	10 ms	Pc411

Application Objects

Index (hex)	Sub-index	Name	Data Type	Access	PDO Mapping	Default Value	Lower Limit	Upper Limit	Unit	Parameter No.
	5	Speed Limit (s1)	UDINT	RO	No	0	0	10000	Vel. unit	Pc412
	6	Speed Limit (s2)	UDINT	RO	No	0	0	10000	Vel. unit	Pc414
	7	Acceleration Limit (a1)	DINT	RO	No	0	-10000	10000	Acc. unit	Pc416
	8	Distance Limit (p1)	DINT	RO	No	0	-2147483648	2147483647	Pos. unit	Pc418
	9	Distance Limit (p2)	DINT	RO	No	0	-2147483648	2147483647	Pos. unit	Pc41A
	10	Distance Limit (p3)	UDINT	RO	No	0	0	4294967295	Pos. unit	Pc41C
	11	Torque Limit (tq1)	UINT	RO	No	0	0	10000	*1	Pc41E
	12	Temperature Limit (tp1)	UINT	RO	No	0	0	2000	*2	Pc41F
	13	Temperature Limit (tp2)	UINT	RO	No	0	0	2000	*2	Pc420

*1: Unit depends on the selected input port in the safety slot setting:

- Port F (0-10 V): 1 mV
- Port G1 (4-20 mA): 2 μ A

*2: Unit depends on the selected input port in the safety slot setting:

- Port F (0-10 V): 5 mV
- Port G1 (4-20 mA): 10 μ A
- Port G2 (PT1000): 0.1 $^{\circ}$ C

Slot 4 Parameters

Index (hex)	Sub-index	Name	Data Type	Access	PDO Mapping	Default Value	Lower Limit	Upper Limit	Unit	Parameter No.
5940h	Slot 4 Parameters									
	0	Number of entries	USINT	RO	No	13	–	–	–	–
	1	Configuration I	UINT	RO	No	0000h	0000h	4B12h	–	Pc480
	2	Configuration II	UINT	RO	No	0000h	0000h	2F39h	–	Pc481
	3	Waiting Time (t1)	UINT	RO	No	0	0	10000	10 ms	Pc490
	4	Monitoring Time (t2)	UINT	RO	No	0	0	10000	10 ms	Pc491
	5	Speed Limit (s1)	UDINT	RO	No	0	0	10000	Vel. unit	Pc492

Index (hex)	Sub-index	Name	Data Type	Access	PDO Mapping	Default Value	Lower Limit	Upper Limit	Unit	Parameter No.
	6	Speed Limit (s2)	UDINT	RO	No	0	0	10000	Vel. unit	Pc494
	7	Acceleration Limit (a1)	DINT	RO	No	0	-10000	10000	Acc. unit	Pc496
	8	Distance Limit (p1)	DINT	RO	No	0	-2147483648	2147483647	Pos. unit	Pc498
	9	Distance Limit (p2)	DINT	RO	No	0	-2147483648	2147483647	Pos. unit	Pc49A
	10	Distance Limit (p3)	UDINT	RO	No	0	0	4294967295	Pos. unit	Pc49C
	11	Torque Limit (tq1)	UINT	RO	No	0	0	10000	*1	Pc49E
	12	Temperature Limit (tp1)	UINT	RO	No	0	0	2000	*2	Pc49F
	13	Temperature Limit (tp2)	UINT	RO	No	0	0	2000	*2	Pc4A0

*1: Unit depends on the selected input port in the safety slot setting:

- Port F (0-10 V): 1 mV
- Port G1 (4-20 mA): 2 µA

*2: Unit depends on the selected input port in the safety slot setting:

- Port F (0-10 V): 5 mV
- Port G1 (4-20 mA): 10 µA
- Port G2 (PT1000): 0.1 °C

Slot 5 Parameters

Index (hex)	Sub-index	Name	Data Type	Access	PDO Mapping	Default Value	Lower Limit	Upper Limit	Unit	Parameter No.
5950h	Slot 5 Parameters									
	0	Number of entries	USINT	RO	No	13	–	–	–	–
	1	Configuration I	UINT	RO	No	0000h	0000h	4B12h	–	Pc500
	2	Configuration II	UINT	RO	No	0000h	0000h	2F39h	–	Pc501
	3	Waiting Time (t1)	UINT	RO	No	0	0	10000	10 ms	Pc510
	4	Monitoring Time (t2)	UINT	RO	No	0	0	10000	10 ms	Pc511
	5	Speed Limit (s1)	UDINT	RO	No	0	0	10000	Vel. unit	Pc512
	6	Speed Limit (s2)	UDINT	RO	No	0	0	10000	Vel. unit	Pc514

Application Objects

Index (hex)	Sub-index	Name	Data Type	Access	PDO Mapping	Default Value	Lower Limit	Upper Limit	Unit	Parameter No.
	7	Acceleration Limit (a1)	DINT	RO	No	0	-10000	10000	Acc. unit	Pc516
	8	Distance Limit (p1)	DINT	RO	No	0	-2147483648	2147483647	Pos. unit	Pc518
	9	Distance Limit (p2)	DINT	RO	No	0	-2147483648	2147483647	Pos. unit	Pc51A
	10	Distance Limit (p3)	UDINT	RO	No	0	0	4294967295	Pos. unit	Pc51C
	11	Torque Limit (tq1)	UINT	RO	No	0	0	10000	*1	Pc51E
	12	Temperature Limit (tp1)	UINT	RO	No	0	0	2000	*2	Pc51F
	13	Temperature Limit (tp2)	UINT	RO	No	0	0	2000	*2	Pc520

*1: Unit depends on the selected input port in the safety slot setting:

- Port F (0-10 V): 1 mV
- Port G1 (4-20 mA): 2 μ A

*2: Unit depends on the selected input port in the safety slot setting:

- Port F (0-10 V): 5 mV
- Port G1 (4-20 mA): 10 μ A
- Port G2 (PT1000): 0.1 $^{\circ}$ C

Slot 6 Parameters

Index (hex)	Sub-index	Name	Data Type	Access	PDO Mapping	Default Value	Lower Limit	Upper Limit	Unit	Parameter No.
5960h	Slot 6 Parameters									
	0	Number of entries	USINT	RO	No	13	–	–	–	–
	1	Configuration I	UINT	RO	No	0000h	0000h	4B12h	–	Pc580
	2	Configuration II	UINT	RO	No	0000h	0000h	2F39h	–	Pc581
	3	Waiting Time (t1)	UINT	RO	No	0	0	10000	10 ms	Pc590
	4	Monitoring Time (t2)	UINT	RO	No	0	0	10000	10 ms	Pc591
	5	Speed Limit (s1)	UDINT	RO	No	0	0	10000	Vel. unit	Pc592
	6	Speed Limit (s2)	UDINT	RO	No	0	0	10000	Vel. unit	Pc594
	7	Acceleration Limit (a1)	DINT	RO	No	0	-10000	10000	Acc. unit	Pc596

Index (hex)	Sub-index	Name	Data Type	Access	PDO Mapping	Default Value	Lower Limit	Upper Limit	Unit	Parameter No.
	8	Distance Limit (p1)	DINT	RO	No	0	-2147483648	2147483647	Pos. unit	Pc598
	9	Distance Limit (p2)	DINT	RO	No	0	-2147483648	2147483647	Pos. unit	Pc59A
	10	Distance Limit (p3)	UDINT	RO	No	0	0	4294967295	Pos. unit	Pc59C
	11	Torque Limit (tq1)	UINT	RO	No	0	0	10000	*1	Pc59E
	12	Temperature Limit (tp1)	UINT	RO	No	0	0	2000	*2	Pc59F
	13	Temperature Limit (tp2)	UINT	RO	No	0	0	2000	*2	Pc5A0

*1: Unit depends on the selected input port in the safety slot setting:

- Port F (0-10 V): 1 mV
- Port G1 (4-20 mA): 2 µA

*2: Unit depends on the selected input port in the safety slot setting:

- Port F (0-10 V): 5 mV
- Port G1 (4-20 mA): 10 µA
- Port G2 (PT1000): 0.1 °C

Slot 7 Parameters

Index (hex)	Sub-index	Name	Data Type	Access	PDO Mapping	Default Value	Lower Limit	Upper Limit	Unit	Parameter No.
5970h	Slot 7 Parameters									
	0	Number of entries	USINT	RO	No	13	–	–	–	–
	1	Configuration I	UINT	RO	No	0000h	0000h	4B12h	–	Pc600
	2	Configuration II	UINT	RO	No	0000h	0000h	2F39h	–	Pc601
	3	Waiting Time (t1)	UINT	RO	No	0	0	10000	10 ms	Pc610
	4	Monitoring Time (t2)	UINT	RO	No	0	0	10000	10 ms	Pc611
	5	Speed Limit (s1)	UDINT	RO	No	0	0	10000	Vel. unit	Pc612
	6	Speed Limit (s2)	UDINT	RO	No	0	0	10000	Vel. unit	Pc614
	7	Acceleration Limit (a1)	DINT	RO	No	0	-10000	10000	Acc. unit	Pc616
	8	Distance Limit (p1)	DINT	RO	No	0	-2147483648	2147483647	Pos. unit	Pc618

Application Objects

Index (hex)	Sub-index	Name	Data Type	Access	PDO Mapping	Default Value	Lower Limit	Upper Limit	Unit	Parameter No.
	9	Distance Limit (p2)	DINT	RO	No	0	-2147483648	2147483647	Pos. unit	Pc61A
	10	Distance Limit (p3)	UDINT	RO	No	0	0	4294967295	Pos. unit	Pc61C
	11	Torque Limit (tq1)	UINT	RO	No	0	0	10000	*1	Pc61E
	12	Temperature Limit (tp1)	UINT	RO	No	0	0	2000	*2	Pc61F
	13	Temperature Limit (tp2)	UINT	RO	No	0	0	2000	*2	Pc620

*1: Unit depends on the selected input port in the safety slot setting:

- Port F (0-10 V): 1 mV
- Port G1 (4-20 mA): 2 μ A

*2: Unit depends on the selected input port in the safety slot setting:

- Port F (0-10 V): 5 mV
- Port G1 (4-20 mA): 10 μ A
- Port G2 (PT1000): 0.1 $^{\circ}$ C

Slot 8 Parameters

Index (hex)	Sub-index	Name	Data Type	Access	PDO Mapping	Default Value	Lower Limit	Upper Limit	Unit	Parameter No.
5980h	Slot 8 Parameters									
	0	Number of entries	USINT	RO	No	13	–	–	–	–
	1	Configuration I	UINT	RO	No	0000h	0000h	4B12h	–	Pc680
	2	Configuration II	UINT	RO	No	0000h	0000h	2F39h	–	Pc681
	3	Waiting Time (t1)	UINT	RO	No	0	0	10000	10 ms	Pc690
	4	Monitoring Time (t2)	UINT	RO	No	0	0	10000	10 ms	Pc691
	5	Speed Limit (s1)	UDINT	RO	No	0	0	10000	Vel. unit	Pc692
	6	Speed Limit (s2)	UDINT	RO	No	0	0	10000	Vel. unit	Pc694
	7	Acceleration Limit (a1)	DINT	RO	No	0	-10000	10000	Acc. unit	Pc696
	8	Distance Limit (p1)	DINT	RO	No	0	-2147483648	2147483647	Pos. unit	Pc698
	9	Distance Limit (p2)	DINT	RO	No	0	-2147483648	2147483647	Pos. unit	Pc69A

Index (hex)	Sub-index	Name	Data Type	Access	PDO Mapping	Default Value	Lower Limit	Upper Limit	Unit	Parameter No.
	10	Distance Limit (p3)	UDINT	RO	No	0	0	4294967295	Pos. unit	Pc69C
	11	Torque Limit (tq1)	UINT	RO	No	0	0	10000	*1	Pc69E
	12	Temperature Limit (tp1)	UINT	RO	No	0	0	2000	*2	Pc69F
	13	Temperature Limit (tp2)	UINT	RO	No	0	0	2000	*2	Pc6A0

*1: Unit depends on the selected input port in the safety slot setting:

- Port F (0-10 V): 1 mV
- Port G1 (4-20 mA): 2 μ A

*2: Unit depends on the selected input port in the safety slot setting:

- Port F (0-10 V): 5 mV
- Port G1 (4-20 mA): 10 μ A
- Port G2 (PT1000): 0.1 $^{\circ}$ C

Slot 9 Parameters

Index (hex)	Sub-index	Name	Data Type	Access	PDO Mapping	Default Value	Lower Limit	Upper Limit	Unit	Parameter No.
5990h	Slot 9 Parameters									
	0	Number of entries	USINT	RO	No	13	--	--	--	--
	1	Configuration I	UINT	RO	No	0000h	0000h	4B12h	--	Pc700
	2	Configuration II	UINT	RO	No	0000h	0000h	2F39h	--	Pc701
	3	Waiting Time (t1)	UINT	RO	No	0	0	10000	10 ms	Pc710
	4	Monitoring Time (t2)	UINT	RO	No	0	0	10000	10 ms	Pc711
	5	Speed Limit (s1)	UDINT	RO	No	0	0	10000	Vel. unit	Pc712
	6	Speed Limit (s2)	UDINT	RO	No	0	0	10000	Vel. unit	Pc714
	7	Acceleration Limit (a1)	DINT	RO	No	0	-10000	10000	Acc. unit	Pc716
	8	Distance Limit (p1)	DINT	RO	No	0	-2147483648	2147483647	Pos. unit	Pc718
	9	Distance Limit (p2)	DINT	RO	No	0	-2147483648	2147483647	Pos. unit	Pc71A
	10	Distance Limit (p3)	UDINT	RO	No	0	0	4294967295	Pos. unit	Pc71C

Application Objects

Index (hex)	Sub-index	Name	Data Type	Access	PDO Mapping	Default Value	Lower Limit	Upper Limit	Unit	Parameter No.
	11	Torque Limit (tq1)	UINT	RO	No	0	0	10000	*1	Pc71E
	12	Temperature Limit (tp1)	UINT	RO	No	0	0	2000	*2	Pc71F
	13	Temperature Limit (tp2)	UINT	RO	No	0	0	2000	*2	Pc720

*1: Unit depends on the selected input port in the safety slot setting:

- Port F (0-10 V): 1 mV
- Port G1 (4-20 mA): 2 μ A

*2: Unit depends on the selected input port in the safety slot setting:

- Port F (0-10 V): 5 mV
- Port G1 (4-20 mA): 10 μ A
- Port G2 (PT1000): 0.1 $^{\circ}$ C

Slot 10 Parameters

Index (hex)	Sub-index	Name	Data Type	Access	PDO Mapping	Default Value	Lower Limit	Upper Limit	Unit	Parameter No.
59A0h	Slot 10 Parameters									
	0	Number of entries	USINT	RO	No	13	–	–	–	–
	1	Configuration I	UINT	RO	No	0000h	0000h	4B12h	–	Pc780
	2	Configuration II	UINT	RO	No	0000h	0000h	2F39h	–	Pc781
	3	Waiting Time (t1)	UINT	RO	No	0	0	10000	10 ms	Pc790
	4	Monitoring Time (t2)	UINT	RO	No	0	0	10000	10 ms	Pc791
	5	Speed Limit (s1)	UDINT	RO	No	0	0	10000	Vel. unit	Pc792
	6	Speed Limit (s2)	UDINT	RO	No	0	0	10000	Vel. unit	Pc794
	7	Acceleration Limit (a1)	DINT	RO	No	0	-10000	10000	Acc. unit	Pc796
	8	Distance Limit (p1)	DINT	RO	No	0	-2147483648	2147483647	Pos. unit	Pc798
	9	Distance Limit (p2)	DINT	RO	No	0	-2147483648	2147483647	Pos. unit	Pc79A
	10	Distance Limit (p3)	UDINT	RO	No	0	0	4294967295	Pos. unit	Pc79C
	11	Torque Limit (tq1)	UINT	RO	No	0	0	10000	*1	Pc79E

Index (hex)	Sub-index	Name	Data Type	Access	PDO Mapping	Default Value	Lower Limit	Upper Limit	Unit	Parameter No.
	12	Temperature Limit (tp1)	UINT	RO	No	0	0	2000	*2	Pc79F
	13	Temperature Limit (tp2)	UINT	RO	No	0	0	2000	*2	Pc7A0

*1: Unit depends on the selected input port in the safety slot setting:

- Port F (0-10 V): 1 mV
- Port G1 (4-20 mA): 2 μ A

*2: Unit depends on the selected input port in the safety slot setting:

- Port F (0-10 V): 5 mV
- Port G1 (4-20 mA): 10 μ A
- Port G2 (PT1000): 0.1 $^{\circ}$ C

Virtual Input Actual Value

Index (hex)	Sub-index	Name	Data Type	Access	PDO Mapping ^{*3}	Default Value	Lower Limit	Upper Limit	Unit	Parameter No.
5A00h	Virtual Input Actual Value									
	0	Number of entries	USINT	RO	No	16	–	–	–	–
	1	Virtual Input 0	BOOL	RO	RxPDO	–	–	–	–	–
	2	Virtual Input 1	BOOL	RO	RxPDO	–	–	–	–	–
	3	Virtual Input 2	BOOL	RO	RxPDO	–	–	–	–	–
	4	Virtual Input 3	BOOL	RO	RxPDO	–	–	–	–	–
	5	Virtual Input 4	BOOL	RO	RxPDO	–	–	–	–	–
	6	Virtual Input 5	BOOL	RO	RxPDO	–	–	–	–	–
	7	Virtual Input 6	BOOL	RO	RxPDO	–	–	–	–	–
	8	Virtual Input 7	BOOL	RO	RxPDO	–	–	–	–	–
	9	Virtual Input 8	BOOL	RO	RxPDO	–	–	–	–	–
	10	Virtual Input 9	BOOL	RO	RxPDO	–	–	–	–	–
	11	Virtual Input 10	BOOL	RO	RxPDO	–	–	–	–	–
	12	Virtual Input 11	BOOL	RO	RxPDO	–	–	–	–	–

Application Objects

Index (hex)	Sub-index	Name	Data Type	Access	PDO Mapping *3	Default Value	Lower Limit	Upper Limit	Unit	Parameter No.
	13	Virtual Input 12	BOOL	RO	RxPDO	–	–	–	–	–
	14	Virtual Input 13	BOOL	RO	RxPDO	–	–	–	–	–
	15	Virtual Input 14	BOOL	RO	RxPDO	–	–	–	–	–
	16	Virtual Input 15	BOOL	RO	RxPDO	–	–	–	–	–

*3: RxPDO: Master Output (Master to Slave) - TxPDO: Master Input (Slave to Master)

Virtual Output Actual Value

Index (hex)	Sub-index	Name	Data Type	Access	PDO Mapping *3	Default Value	Lower Limit	Upper Limit	Unit	Parameter No.
5A01h	Virtual Output Actual Value									
	0	Number of entries	USINT	RO	No	16	–	–	–	–
	1	Virtual Output 0	BOOL	RO	TxPDO	–	–	–	–	–
	2	Virtual Output 1	BOOL	RO	TxPDO	–	–	–	–	–
	3	Virtual Output 2	BOOL	RO	TxPDO	–	–	–	–	–
	4	Virtual Output 3	BOOL	RO	TxPDO	–	–	–	–	–
	5	Virtual Output 4	BOOL	RO	TxPDO	–	–	–	–	–
	6	Virtual Output 5	BOOL	RO	TxPDO	–	–	–	–	–
	7	Virtual Output 6	BOOL	RO	TxPDO	–	–	–	–	–
	8	Virtual Output 7	BOOL	RO	TxPDO	–	–	–	–	–
	9	Virtual Output 8	BOOL	RO	TxPDO	–	–	–	–	–
	10	Virtual Output 9	BOOL	RO	TxPDO	–	–	–	–	–
	11	Virtual Output 10	BOOL	RO	TxPDO	–	–	–	–	–
	12	Virtual Output 11	BOOL	RO	TxPDO	–	–	–	–	–
	13	Virtual Output 12	BOOL	RO	TxPDO	–	–	–	–	–
	14	Virtual Output 13	BOOL	RO	TxPDO	–	–	–	–	–

Index (hex)	Sub-index	Name	Data Type	Access	PDO Mapping *3	Default Value	Lower Limit	Upper Limit	Unit	Parameter No.
	15	Virtual Output 14	BOOL	RO	TxPDO	–	–	–	–	–
	16	Virtual Output 15	BOOL	RO	TxPDO	–	–	–	–	–

*3: RxPDO: Master Output (Master to Slave) - TxPDO: Master Input (Slave to Master)

Slot Status Actual Value

Index (hex)	Sub-index	Name	Data Type	Access	PDO Mapping *3	Default Value	Lower Limit	Upper Limit	Unit	Parameter No.
5A02h	Slot Status Actual Value									
	0	Number of entries	USINT	RO	No	10	–	–	–	–
	1	SF_1	BOOL	RO	TxPDO	–	–	–	–	–
	2	SF_2	BOOL	RO	TxPDO	–	–	–	–	–
	3	SF_3	BOOL	RO	TxPDO	–	–	–	–	–
	4	SF_4	BOOL	RO	TxPDO	–	–	–	–	–
	5	SF_5	BOOL	RO	TxPDO	–	–	–	–	–
	6	SF_6	BOOL	RO	TxPDO	–	–	–	–	–
	7	SF_7	BOOL	RO	TxPDO	–	–	–	–	–
	8	SF_8	BOOL	RO	TxPDO	–	–	–	–	–
	9	SF_9	BOOL	RO	TxPDO	–	–	–	–	–
	10	SF_10	BOOL	RO	TxPDO	–	–	–	–	–

*3: RxPDO: Master Output (Master to Slave) - TxPDO: Master Input (Slave to Master)

I/O Terminal Actual Value

Index (hex)	Sub-index	Name	Data Type	Access	PDO Mapping *3	Default Value	Lower Limit	Upper Limit	Unit	Parameter No.
5A03h	I/O Terminal Actual Value									
	0	Number of entries	USINT	RO	No	14	–	–	–	–
	1	PIO_A1	BOOL	RO	TxPDO	–	–	–	–	–
	2	PIO_A2	BOOL	RO	TxPDO	–	–	–	–	–
	3	PIO_B1	BOOL	RO	TxPDO	–	–	–	–	–
	4	PIO_B2	BOOL	RO	TxPDO	–	–	–	–	–
	5	PIO_C1	BOOL	RO	TxPDO	–	–	–	–	–
	6	PIO_C2	BOOL	RO	TxPDO	–	–	–	–	–
	7	PIO_D1	BOOL	RO	TxPDO	–	–	–	–	–

Application Objects

Index (hex)	Sub-index	Name	Data Type	Access	PDO Mapping *3	Default Value	Lower Limit	Upper Limit	Unit	Parameter No.
	8	PIO_D2	BOOL	RO	TxPDO	–	–	–	–	–
	9	PIO_E1	BOOL	RO	TxPDO	–	–	–	–	–
	10	PIO_E2	BOOL	RO	TxPDO	–	–	–	–	–
	11	PIO_F1	BOOL	RO	TxPDO	–	–	–	–	–
	12	PIO_F2	BOOL	RO	TxPDO	–	–	–	–	–
	13	PIO_G1	BOOL	RO	TxPDO	–	–	–	–	–
	14	PIO_G2	BOOL	RO	TxPDO	–	–	–	–	–

*3: RxPDO: Master Output (Master to Slave) - TxPDO: Master Input (Slave to Master)

Multi Monitor Demand Value (MPD)

Index (hex)	Sub-index	Name	Data Type	Access	PDO Mapping *3	Default Value	Lower Limit	Upper Limit	Unit	Parameter No.
5A04h	Multi Monitor Demand Value (MPD)									
	0	Number of entries	USINT	RO	No	4	–	–	–	–
	1	MPD 0	BOOL	RO	RxPDO	–	–	–	–	–
	2	MPD 1	BOOL	RO	RxPDO	–	–	–	–	–
	3	MPD 2	BOOL	RO	RxPDO	–	–	–	–	–
	4	MPD 3	BOOL	RO	RxPDO	–	–	–	–	–

*3: RxPDO: Master Output (Master to Slave) - TxPDO: Master Input (Slave to Master)

Multi Monitor Actual Value (MPA)

Index (hex)	Sub-index	Name	Data Type	Access	PDO Mapping *3	Default Value	Lower Limit	Upper Limit	Unit	Parameter No.
5A05h	Multi Monitor Actual Value (MPA)									
	0	Number of entries	USINT	RO	No	4	–	–	–	–
	1	MPA 0	BOOL	RO	TxPDO	–	–	–	–	–
	2	MPA 1	BOOL	RO	TxPDO	–	–	–	–	–
	3	MPA 2	BOOL	RO	TxPDO	–	–	–	–	–
	4	MPA 3	BOOL	RO	TxPDO	–	–	–	–	–

*3: RxPDO: Master Output (Master to Slave) - TxPDO: Master Input (Slave to Master)

Multi Monitor 1 Actual Value

Index (hex)	Sub-index	Name	Data Type	Access	PDO Mapping *3	Default Value	Lower Limit	Upper Limit	Unit	Parameter No.
5A06h	Multi Monitor 1 Actual Value									
	0	Number of entries	USINT	RO	No	2	–	–	–	–
	1	Multi Monitor 1 Actual Value (1st word)	UINT	RO	TxPDO	–	–	–	–	–
	2	Multi Monitor 1 Actual Value (2nd word)	UINT	RO	TxPDO	–	–	–	–	–

*3: RxPDO: Master Output (Master to Slave) - TxPDO: Master Input (Slave to Master)

Multi Monitor 2 Actual Value

Index (hex)	Sub-index	Name	Data Type	Access	PDO Mapping *3	Default Value	Lower Limit	Upper Limit	Unit	Parameter No.
5A07h	Multi Monitor 2 Actual Value									
	0	Number of entries	USINT	RO	No	2	–	–	–	–
	1	Multi Monitor 2 Actual Value (1st word)	UINT	RO	TxPDO	–	–	–	–	–
	2	Multi Monitor 2 Actual Value (2nd word)	UINT	RO	TxPDO	–	–	–	–	–

*3: RxPDO: Master Output (Master to Slave) - TxPDO: Master Input (Slave to Master)

FSoE Error

Index (hex)	Sub-index	Name	Data Type	Access	PDO Mapping *3	Default Value	Lower Limit	Upper Limit	Unit	Parameter No.
5A08h	0	FSoE Error	BOOL	RO	TxPDO	–	–	–	–	–

*3: RxPDO: Master Output (Master to Slave) - TxPDO: Master Input (Slave to Master)

FSoE Error Ack

Index (hex)	Sub-index	Name	Data Type	Access	PDO Mapping *3	Default Value	Lower Limit	Upper Limit	Unit	Parameter No.
5A09h	0	FSoE Error Ack	BOOL	RO	RxPDO	–	–	–	–	–

*3: RxPDO: Master Output (Master to Slave) - TxPDO: Master Input (Slave to Master)

Application Objects

Safety Slot Actual Value 1

Index (hex)	Sub-index	Name	Data Type	Access	PDO Mapping	Default Value	Lower Limit	Upper Limit	Unit	Monitor No.
5A0Ah	Safety Slot Actual Value 1									
	0	Number of entries	USINT	RO	No	8	–	–	–	–
	1	Selected Slot number	UINT	RO	No	–	–	–	–	Un0AC
	2	Actual Position Limit 1	DINT	RO	No	–	–	–	Pos. unit	Un0AD
	3	Actual Position Limit 2	DINT	RO	No	–	–	–	Pos. unit	Un0AE
	4	Actual Speed Limit 1	DINT	RO	No	–	–	–	Vel. unit	Un0AF
	5	Actual Speed Limit 2	DINT	RO	No	–	–	–	Vel. unit	Un0B0
	6	Actual Acceleration Limit	DINT	RO	No	–	–	–	Acc. unit	Un0B1
	7	Actual Torque Limit	INT	RO	No	–	–	–	*1	Un0B2
	8	Actual Temperature Limit	INT	RO	No	–	–	–	*2	Un0B3

*1: Unit depends on the selected input port in the safety slot setting:

- Port F (0-10 V): 1 mV
- Port G1 (4-20 mA): 2 µA

*2: Unit depends on the selected input port in the safety slot setting:

- Port F (0-10 V): 5 mV
- Port G1 (4-20 mA): 10 µA
- Port G2 (PT1000): 0.1 °C

Safety Slot Actual Value 2

Index (hex)	Sub-index	Name	Data Type	Access	PDO Mapping ^{*3}	Default Value	Lower Limit	Upper Limit	Unit	Monitor No.
5A0Bh	Safety Slot Actual Value 2									
	0	Number of entries	USINT	RO	No	11	–	–	–	–
	1	Safety Function Status for Slot 1 to 8	UDINT	RO	No	–	–	–	–	Un0A3, Un0A4, Un0A5, Un0A6

Index (hex)	Sub-index	Name	Data Type	Access	PDO Mapping *3	Default Value	Lower Limit	Upper Limit	Unit	Monitor No.
	2	Safety Function Status for Slot 9 to 10	UDINT	RO	No	–	–	–	–	Un0A7
	3	Actual Position (Monitoring)	DINT	RO	No	–	–	–	Pos. unit	Un0B6
	4	Actual Position	DINT	RO	No	–	–	–	Pos. unit	Un0B7
	5	Actual Speed	DINT	RO	No	–	–	–	Vel. unit	Un0B8
	6	Actual Acceleration	DINT	RO	No	–	–	–	Vel. unit	Un0B9
	7	Actual Torque	INT	RO	No	–	–	–	*1	Un0BA
	8	Actual Temperature	INT	RO	No	–	–	–	*2	Un0BB
	9	Actual Position Encoder 2	DINT	RO	No	–	–	–	Pos. unit	Un0BD
	10	SHP Status	BOOL	RO	TxPDO	–	–	–	–	Un0C0
	11	SHP Encoder Position	DINT	RO	No	–	–	–	Pos. unit	Un0C1

*1: Unit depends on the selected input port in the safety slot setting:

- Port F (0-10 V): 1 mV
- Port G1 (4-20 mA): 2 μ A

*2: Unit depends on the selected input port in the safety slot setting:

- Port F (0-10 V): 5 mV
- Port G1 (4-20 mA): 10 μ A
- Port G2 (PT1000): 0.1 $^{\circ}$ C

*3: RxPDO: Master Output (Master to Slave) - TxPDO: Master Input (Slave to Master)

Analog Input Actual Value

Index (hex)	Sub-index	Name	Data Type	Access	PDO Mapping	Default Value	Lower Limit	Upper Limit	Unit	Monitor No.
5A0Ch	Analog Input Actual Value									
	0	Number of entries	USINT	RO	No	4	–	–	–	–
	1	Port F1	INT	RO	No	–	–	–	mV	Un0C2
	2	Port F2	INT	RO	No	–	–	–	mV	Un0C3
	3	Port G1	INT	RO	No	–	–	–	μ A	Un0C4
	4	Port G2	INT	RO	No	–	–	–	0.1 $^{\circ}$ C	Un0C5

C Device Combinations

Only the models of SERVOPACKs, servomotors, serial converter units etc. listed here can be used in combination with the safety module.

Combination with SERVO-PACKs

SERVOPACK Models

SGD7S-□□□DA0□8□□F91

Combination with Servomotors

All Sigma-7 Series rotary servomotors that are supported by the SGD7S-□□□DA0□8□□F91 SERVOPACK.

Any model of linear servomotor that is supported by the SGD7S-□□□DA0□8□□F91 SERVOPACK.

Combination with Serial Converter Units

Serial Converter Unit Model

Serial Converter Unit Model

Without hall sensor, by Heidenhain	JZDP-H003-□□□-E
	JZDP-J003-□□□-E

Without hall sensor, by Renishaw	JZDP-H005-□□□-E
	JZDP-J005-□□□-E

With hall sensor, by Heidenhain	JZDP-H006-□□□-E
	JZDP-J006-□□□-E

With hall sensor, by Renishaw	JZDP-H008-□□□-E
	JZDP-J008-□□□-E

Combination with Other Option Modules

SERVOPACK	Option Module	Combination possible
400 V model	Command Option Module	not applicable
	SGDV-OFB04A „Resolver“	yes
	SGDV-OFA01 „Yaskawa Encoder“	yes

Combination with 2nd Encoder

The primary encoder will be the internal encoder of the Yaskawa motor for rotary motors. For linear motors the used encoder depends on the Serial Converter Unit that is used.

To achieve SIL3 applications the user has to add a second encoder to the SERVOPACK.

The secondary encoder can be one of the linear types used for primary encoder. For rotary systems, a resolver can be used with the option card *SGDV-OFB04A*. Or the customer can use the Yaskawa encoder (Type code: JZDP-Z001-000, JZDP-Z002-000) together with the option card *SGDV-OFA01*.

Combination with Tools

The safety module will be configured via a separate PC tool (→ [‘Advanced Safety Module Parameter Editor’...page 124](#)).

The allowed combinations of SERVOPACK FT91 firmware, safety module firmware and SigmaWin+ version can be found in → [‘Allowed compatible software versions’...page 38](#)

Advanced Safety Module

for Sigma-7 SERVOPACK SGD7S-□□□DA0□8□□F91, 400 V

Product Manual

YASKAWA EUROPE GmbH

Philipp-Reis-Str. 6
65795 Hattersheim
Germany
Phone: +49-6196-569-300
Fax: +49-6196-569-398
www.yaskawa.eu
E-mail: info@yaskawa.eu

YASKAWA AMERICA, INC.

2121, Norman Drive South,
Waukegan, IL 60085, U.S.A.
Phone: +1-800-YASKAWA (927-
5292) or +1-847-887-7000
Fax: +1-847-887-7310
www.yaskawa.com

YASKAWA ELECTRIC CORPORATION

2-1 Kurosakishiroishi,
Yahatanishi-ku, Kitakyushu
806-0004 Japan
Phone: +81-93-645-8801
www.yaskawa.co.jp

Importer United Kingdom

YASKAWA ELECTRIC UK LTD.

1 Hunt Hill, Orchardton Woods,
Cumbernauld, G68 9 LF,
United Kingdom
Phone: +44 (0) 1236-735000

In the event that the end user of this product is to be the military and said product is to be employed in any weapons systems or the manufacture thereof, the export will fall under the relevant regulations as stipulated in the Foreign Exchange and Foreign Trade Regulations. Therefore, be sure to follow all procedures and submit all relevant documentation according to any and all rules, regulations and laws that may apply. Specifications are subject to change without notice for ongoing product modifications and improvements. Contact Yaskawa or your nearest sales representative for details on the contents of this manual.

© 2024 YASKAWA Europe GmbH



YASKAWA EUROPE GmbH

SIEP YEUS7S 01B
Revision 3
July 2024
Published in Germany
Original Instructions

Packing Materials



YASKAWA