

YASKAWA

GA700

AC Drives for Industrial Applications



Limitless Possibilities

Incredibly reliable, easy to use, and powerful!

At Yaskawa, we know your time is valuable. That's why we've designed this variable speed drive to meet all your needs. Offering world class Yaskawa quality, along with intuitive interaction and high flexibility, our new GA700 is meant to easily handle nearly any application.

Discover the limitless possibilities of GA700!



With a flexible motor control, powerful and extendable functionality, and a broad power range up to 630 kW, the GA700 is the drive of choice for almost any task, ranging from simple transportation, presses and others up to complex systems with network connected drives or the demand for higher levels of safety.

Equally impressive to its robust, powerful and flexible design are innovative features like the tuning-less vector control, the haptic keypad with guided configuration and DriveWizard Mobile, the app for smart phones and tablets.

Combine all this with modern safety features and a variety of environmental solutions, and you will need to look no further than GA700 for all your variable speed needs.

Our Commitment to You

Effortless network integration

- Supports all major networks with a new cost effective network integration feature
- Maintain network communications even during loss of main input power

One for all

- Precise and tuning-less motor control with one drive controlling any induction, permanent magnet or synchronous reluctance motor

Quick & easy set-up

- Reduce set-up time with an intuitive keypad, navigation and start-up wizards

Powerful configuration tools

- DriveWizard® and DriveWorksEZ® are PC tools for drive management and logic programming
- DriveWizard® for drive management, start-up and failure analysis
- DriveWorksEZ® for extending functionality by logic programming

Convenient set-up and monitoring

- Safe programming without main power connected
- Cloud-connected DriveWizard® Mobile app for drive management on smartphones and tablets.

Integrated functional safety

- Increased safety and reliability with STO SIL3 functional safety

Meets global standards

- Local/global standards
- RoHS compliant

Flexible package design

- Designed with flexibility to simplify installation and cabinet design

Flexibility, ease of use and a sustainable design for the best value proposition in your application



200 V class: 0.55 - 110 kW

400 V class: 0.55 - 630 kW

Effortless network integration

GA700 drives support all the major industrial communications and connection topologies (ring, star, line, etc.) to adapt to various factory automation networks. Reduce wiring when connecting to an upper level controller or PLC through available built-in protocols and/or dedicated communication options.

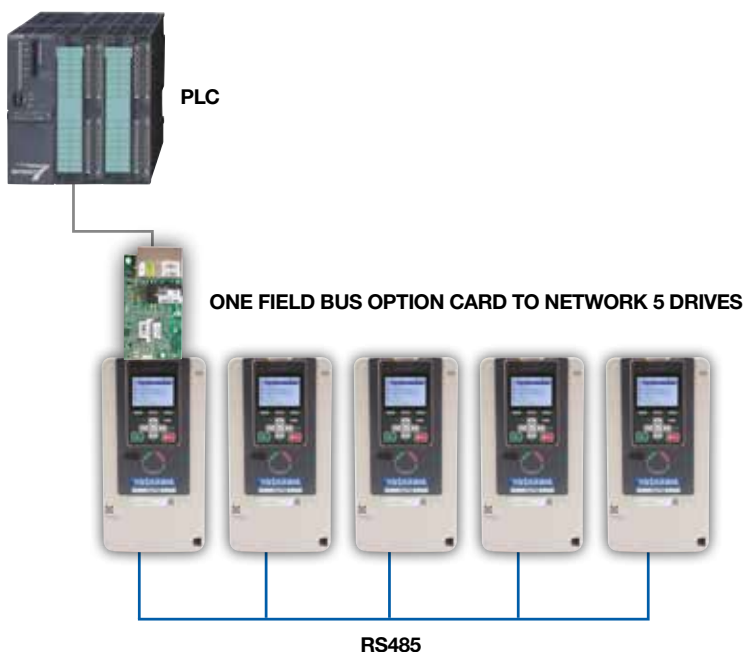

Network integration benefits/features:

Easy integration into your network

- Supports all major networks and topologies
- Network compliance tested
- Network up to 5 drives with a single communication card

Cost savings with built-in protocols

- RS-485 MEMOBUS/Modbus protocol
- 115.2 kbit/s communication speeds

Keep control during main power loss

- Embedded +24 VDC input control power standard
- Programming and monitoring without main power

Cost effective integration

Up to five GA700 drives can be accessed through only one fieldbus option card, thus providing a cost effective solution with reduced wiring effort.

Embedded +24 VDC input

When supplying the GA700 through the built in 24 VDC control power input, network communications can be maintained even during main power loss, thus allowing continuous monitoring and faster start up on power recovery.



DeviceNet™ EtherNet/IP™

EtherCAT®

ETHERNET POWERLINK

CC-Link

CANopen

Modbus

MECHATROLINK

PROFINET

PROFIBUS



One for all

The GA700 precisely controls induction motors, permanent magnet motors and synchronous reluctance motors providing versatility to run a variety of applications with just one drive. The times of complex motor set-up are over. With the new EZ vector mode, the GA700 can run all of these motor types without comprehensive tuning.

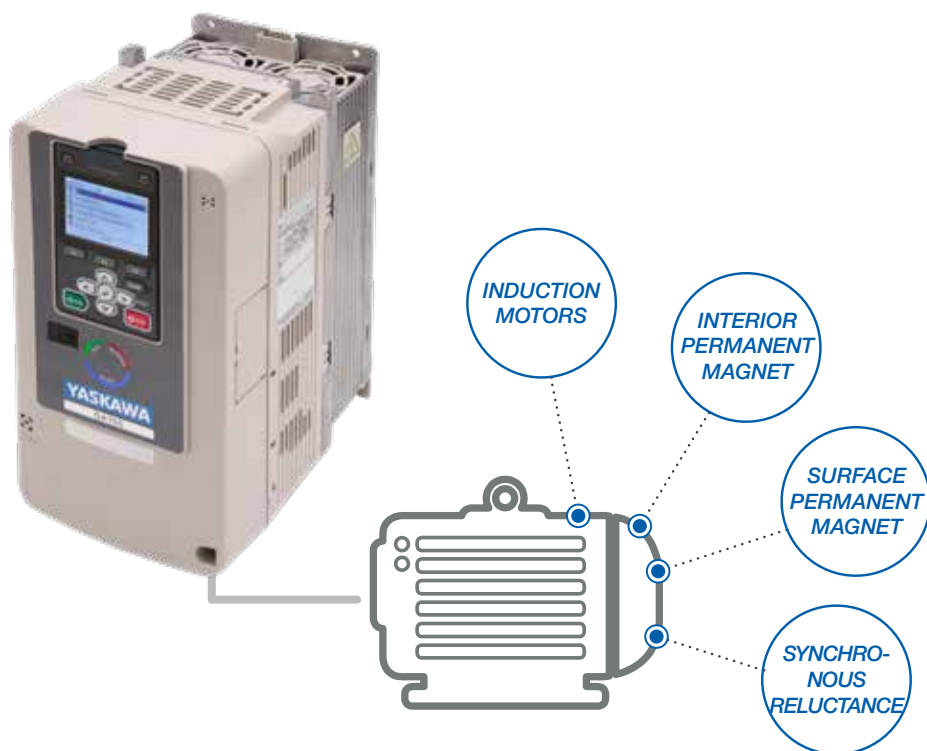

Motor control benefits and features:

Flexible motor control

- Tuning-less with EZ vector
- Open/closed loop speed or torque control
- Induction/permanent magnet motors
- 590 Hz max. output frequency
- Zero speed control without encoder
- Synchronous reluctance motor control
- Motor speed control range in closed loop mode of 1:1500

Energy savings

- Automatic energy efficiency optimization function

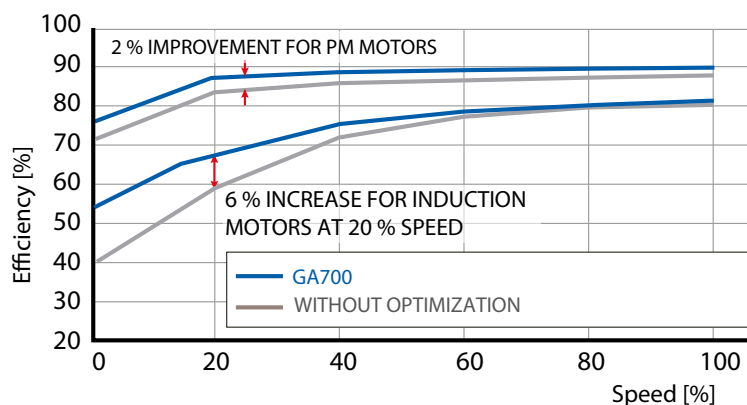

Maximum efficiency

By introducing motor speed control as a replacement of gears, valves or dampers the GA700 unlocks great energy saving potential in various applications. In addition, the GA700 automatically optimizes the motor efficiency for any speed and load condition and minimizes overall losses.

GA700 lowers energy cost by running your application at maximum efficiency.

Quick & easy set-up

The GA700 provides a user programming experience with an intuitively-designed keypad and tactile user interface. Self-guiding navigation menus and start-up wizards make the programming and set-up faster and easier than ever. With DriveWizard Mobile the GA700 can easily be managed and controlled from your smartphone or tablet.

Mobile Device Connectivity

Mobile device connectivity is achieved through using the built-in USB port or wireless communication with the Bluetooth® LCD keypad option.



1. Bluetooth keypad optional
2. Supports Android and iOS



Copy function
Multiple sets of parameters can be stored and easily transferred (copied) to additional drives

Hi-resolution display
Contrast control offers clear and readable full-text descriptions

Automatic backup function
Saves the current parameter settings after a period of user inactivity. After an incident, settings can be retrieved from the keypad in a couple of seconds.

Advanced keypad navigation
Faster scrolling and function keys offer faster navigation and short-cuts reducing programming time



Micro SD storage
Micro SD for data logging storage

Real-time clock
Real-time clock for time stamp of fault information (battery compartment in back)

Optional LCD keypad with Bluetooth®
Wireless communication capability between the mobile device and drive

Keypad benefits and features:

Reduce set-up time

- Start-up wizard
- Favorite parameter/monitor function
- Copy function integrated into the keypad
- Parameter set is backward compatible with previous generation drive products
- Fast navigation
- Parameter description

Drive parameter management

- Storage of up to 4 drive parameter sets
- Data logging with real time stamp e.g. for fault analysis, load profile analysis etc. (up to 32 GB on a Micro SD card)
- Fault logging with real time stamp for better analysis
- Multiple parameter storage
- Automatic parameter back-up

Easy to use

- LCD keypad with Bluetooth® option
- Display contrast control
- Real-time clock with time stamp
- Tactile feel buttons
- Remote mounting of keypad using standard RJ45 extension cable

Start-up wizard

Reduce basic set-up time to minutes using the start-up wizard without any drive parameter knowledge



Powerful configuration tools

DriveWizard® is an offline/online parameter and drive configuration tool. The easy and intuitive tool is used for set-up, maintenance and troubleshooting offering parameter editing, storing and file comparison as well as online trending using the highly functional oscilloscope feature.

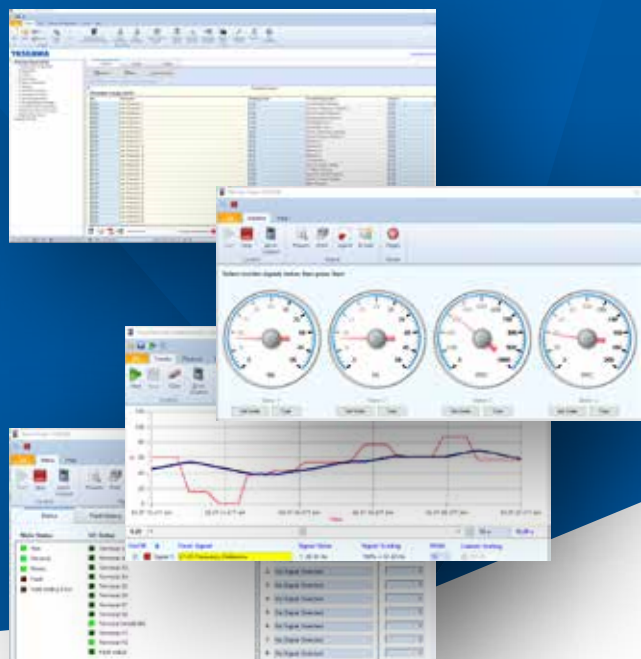

Easy commissioning without power

GA700 can be programmed without any power supply connected. Simply plug into a USB port of your PC, start programming and enjoy the ease of commissioning.

Customizable



The GA700 further enhances the programming experience with DriveWorksEZ®. DriveWorksEZ® offers an icon-based, drag-and-drop graphical environment to add programmable functions that can tailor the drive to meet various machine and application requirements without the cost of external controllers, such as PLCs or additional controller hardware options.

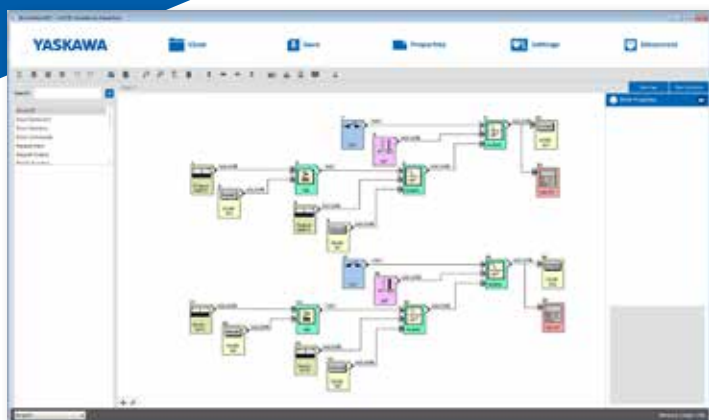

 DriveWorksEZ



Easy programming

DriveWorksEZ® is the intuitive graphical programming environment for the GA700. Create customized functions for your application in shortest time by drag and drop function blocks. The online diagnosis tool supports testing.

Application toolbox benefits and features:

Drive management with DriveWizard®

- Parameter management
- Online manual
- Report generation and export data
- 6 channel scope function
- Real-time monitoring
- Access through USB, EtherNet/IP, Modbus TCP/IP, or PROFINET
- Automatic parameter conversion from previous series drives

Customizable with DriveWorksEZ®

- Icon-based graphics
- Drag and drop graphical interface
- Select from 300+ function blocks
- Access to I/Os, network interfaces, drive parameters and monitors
- Logic/math functions
- Timers/counters
- Subroutine creation
- Up to 200 connections



Convenient set-up and monitoring

Using DriveWizard Mobile the GA700 can be set up, controlled and monitored from your smartphone or tablet easily and intuitively. Connected with the YASKAWA Drive Cloud, DriveWizard Mobile provides quick access to latest product manuals and your drive data, anywhere and anytime.

DriveWizard® Mobile app

DriveWizard® Mobile turns your smartphone or tablet into a control center for your GA700 drives. It allows parameter setup and drive control but also back up your drive data locally on your smart device or in the YASKAWA Drive Cloud. With DriveWizard® Mobile all your information for parameter setup and troubleshooting of your GA700 drives are in your pocket when you need them.

Scanning the drive QR code can provide easy access to drive information and status with the DriveWizard Mobile application software.





YASKAWA Drive Cloud service

With the YASKAWA Drive Cloud, we provide free drive registration access to latest product information and online storage for parameter and application backup data. YASKAWA Drive Cloud is the easy and safe way to keep a record of your drive data and to have them available whenever you need them.



Convenient setup and monitoring:

DriveWizard® Mobile app

- Quick and easy drive management apps for smart devices
- Easy USB OTG cable or Bluetooth® connection
- Drive registration via cloud by scanning QR code
- Paperless and easy access to latest online manual and troubleshooting
- Archive and retrieve parameter settings with comments on your smart device
- Carefree data recovery: Parameter back-up/retrieval anytime via cloud service for registered drives

YASKAWA Drive Cloud service

- Online manual
- Complimentary storage for parameter backup and application records
- Convenient drive data storage accessible anywhere
- Direct access to your personal GA700 data package

Search for

YASKAWA

on



Flexible and reliable

No matter if you put the drive in a control cabinet or at a wall, in clean or harsh environment, the flexible package design of the GA700 allows a reliable operation under various environmental conditions.



Coated board protection

Coated PCBs as standard protect the electronics from dust or humidity and ensure reliable operation even in a harsh environment (IEC 60721-3-3, 3C2, 3S2).



Minimum footprint

The small footprint of the GA700 provides best usage of available panel space. Optimized heat management results in an up to 50% smaller footprint compared to previous drives.





Enhanced product benefits and features:

Easy to install and maintain

- IP20 standard
- NEMA Type 1 kit optional
- NEMA Type 12/IP55 protected heatsink
- Coated boards
- Side-by-side mounting
- Built-in braking transistor (up to 90 kW)

Reduce harmonics and emissions

- Built-in EMC filter, possible to disable
- Built-in DC reactor (22 kW (HD) and above)

Side-by-side mounting

The GA700 can be mounted side-by-side with bottom entry wiring to reduce cabinet size.



Horizontal mounting

The GA700 can be mounted horizontally up to 90 kW (ND).





Integrated Functional Safety

With the built-in dual channel STO (safe torque off) circuit and EDM signal (electronic device monitor) the GA700 provides the right tools for an easy integration of emergency stop functions into machines, even when higher levels of safety are required.

Functional safety benefits and features:

Risk reduction made easy

- STO with SIL3/PLe according to IEC 61800-5-2/IEC 61508/ISO 13849
- EDM monitor
- Lower number of parts reduces installation effort while increasing reliability
- TÜV Süd certified



Embedded functional safety

The built-in STO replaces mechanical emergency relays. The electronic sequencing improves reliability and cost compared to mechanical components.

Specifications

Operating environment	
Ambient temperature	-10 to +50 °C (IP20), -10 to +40 °C (NEMA 1), up to +60 °C with derating
Storage temperature	-20 to +70 °C
Humidity	95 % RH or less (non-condensing)
Altitude	Up to 1000 m without derating, up to 4000 m with derating.
Vibration/Shock	10 to 20 Hz: 9.8 m/s ² 20 to 55 Hz: 5.9 m/s ² (2004 to 2211; 4002 to 4168) 2 m/s ² (2257 to 2415; 4208 to 4675), according to EN60068-2-6
Protection design	IP20 standard, NEMA Type 1-Kit (optional), IP55/NEMA Type 12 external heatsink (factory option)
Mounting	Upright / Side-by-side (2004 to 2082; 4002 to 4044), Horizontal (2004 to 2257; 4002 to 4140)
Environmental conditions	IEC 60721-3-3, Class 3CS (chemical gases), Class 3S2 (solid particles)
Conformity / Standards	
Standards	CE, UL, cUL, EAC, RoHS
Functional safety	Safe Torque Off (STO) according to IEC 61800-5-2, tested according IEC/EN61508 (SIL3) and ISO/EN13849-1 (PI e, Cat. 3); TÜV Süd certified
Power ratings	
Overload capacity	150 %/1 min. (HD, heavy duty) or 110 %/1 min. (ND, normal duty)
Rated voltage	200 to 240 VAC, -15 to +10 %, 50/60 Hz +/-5 % 380 to 480 VAC, -15 to +10 %, 50/60 Hz +/-5 %
Capacity range (ND)	200 V class: 0.55 to 110 kW 400 V class: 0.55 to 355 kW
Output frequency	0 to 590 Hz
Carrier frequency	8 kHz (HD) or 2 kHz (ND); max. 15 kHz
DC link choke	built-in (2110 to 2415; 4060 to 4675)
Braking transistors	built-in (2004 to 2313; 4002 to 4168)
Control / Programming	
Control inputs	8 digital (sink/source), 3 analog (current/voltage), 1 pulse (HTL, max. 32 kHz), 24 VDC power supply for control cards
Control outputs	4 digital, 2 analog (current/voltage), 1 pulse (HTL, max 32 kHz), 24 VDC for external sensors available (max. 150 mA)
Virtual input/output	For connection of I/O functions without physical wiring Multiple assignment of I/O functions for easier wiring
Programming interface	Mini-USB on the front cover; digital operator with Bluetooth® (optional)
Operator	LCD with copy function for several parameter sets, real time clock, data logging, Bluetooth® (optional)



Specification overview

Motor Control		
Motor types	Induction Motor (IM), Permanent Magnet Motor (IPM/SPM), Synchronous Reluctance Motor (SynRM)	
Control methods	V/f and Vector control with/without encoder, EZVector	
Speed control	With and without speed encoder	
Zero speed	With and without speed encoder	
Motor parameter tuning	Automatic, rotating/static	
Further Functions		
Integrated PID controller with sleep function		
Automatic balance of load level between two motors that operate the same load (droop control)		
Automatic main power loss ride through		
Speed Search function for smooth start of coasting motors		
Braking with over-magnetization for fast stop without braking resistors		
Energy-saving function		
Automatic restart after failure		
Overvoltage suppression		
Protection / Monitoring		
Protective functions	Stall prevention, overload prevention, overtemperature prevention- and further protective functions for the motor, the application and the inverter drive	
Self-monitoring	Monitoring of main components (fans, IGBTs, capacitors, charging circuit) with lifetime monitoring	
Options		Model code
Communication	CANopen	SI-S3
	CC-Link	SI-C3
	DeviceNet	SI-N3
	MECHATROLINK-II	SI-T3
	MECHATROLINK-III	SI-ET3
	Multi-protocol Option Card (incl. EtherCAT, Ethernet/IP, Modbus/TCP, PROFINET)	JOHB-SMP3
	POWERLINK	SI-EL3
	PROFIBUS-DP	SI-P3
Motor feedback	Incremental Encoder (Line Driver)	PG-X3
	Complimentary Encoder (HTL, Open-Collector)	PG-B3
	Resolver Interface for TS2640N321E64	PG-RT3
Input/Output	Analog Input: 3-channel, -/+10 V (13-bit signed) / (0) 4 to 20 mA (12-bit)	AI-A3
	Analog Output: 2-channel, -/+10 V (11-bit signed)	AO-A3
	Digital Input: 16 Digital inputs, +24 V, at 8 mA each, sink or source, multi-function or frequency reference (16-bit binary or BCD)	DI-A3
	Digital Output: 6 photocoupler (48 V, 50 mA), 2 relay contacts (250 VAC/30 VDC, 1 A max.)	DO-A3
Other options	Bluetooth® keypad, Attachment for external heatsink, External EMC filter, Shield clamp kit, AC chokes, Harmonics filter, Output chokes, Braking resistors, Braking chopper	

Connection diagram

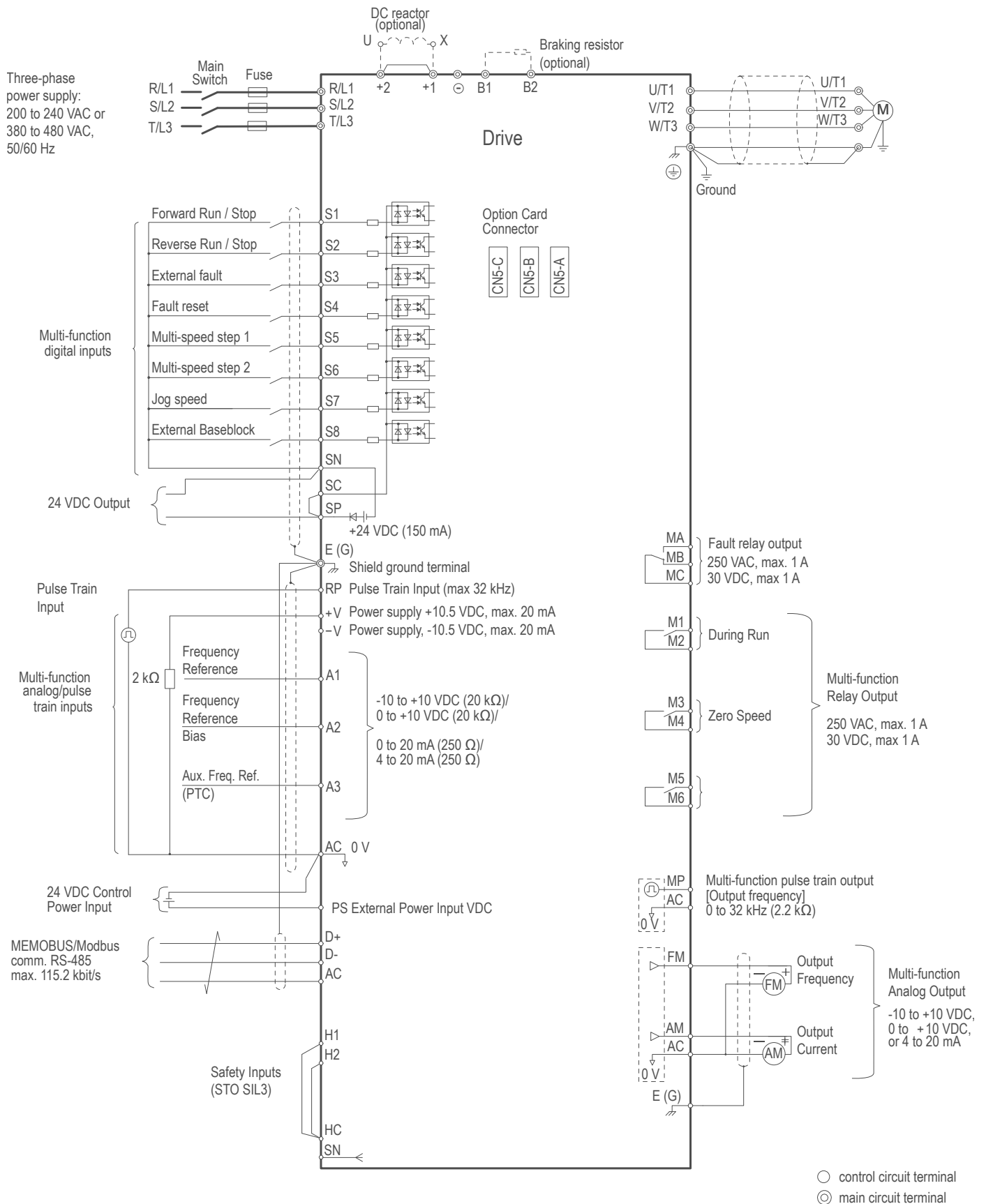

Technical data

Catalog code

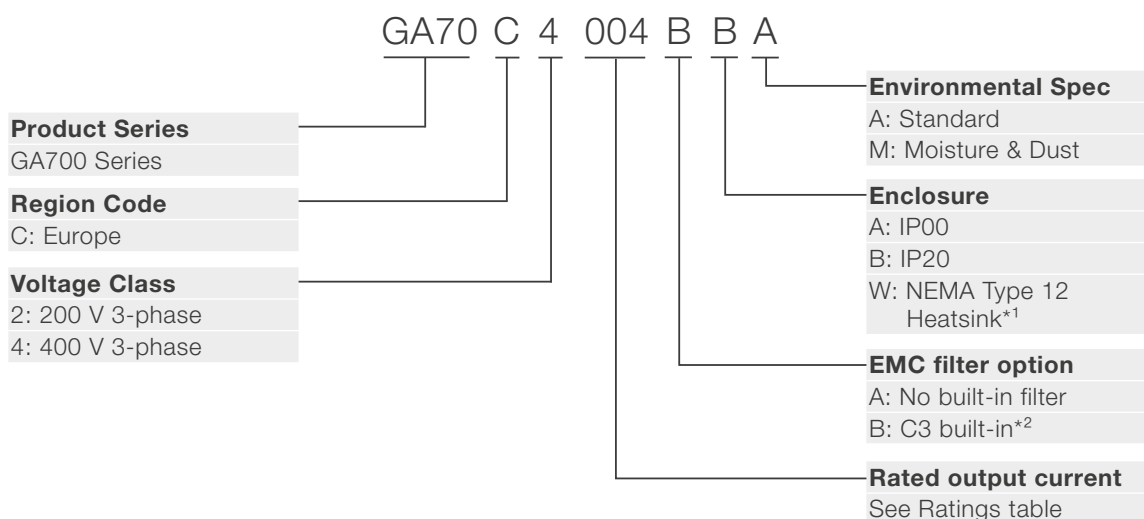

^{*1} Only available for 400 V class drives up to 675 A.

^{*2} Only available for drives up to 675 A.

Ratings

200 - 240 VAC, 3-phase

Catalog code GA70C□□□□BBA	Max applicable motor power	Rated output current	Dimensions [mm]			Weight [kg]
	HD / ND [kW]	HD / ND [A]	Height	Width	Depth	
2004	0.55 / 0.75	3.2 / 3.5	260	140	176	3.5
2006	0.75 / 1.1	5.0 / 6.0				
2010	1.5 / 2.2	8.0 / 9.6				
2012	2.2 / 3.0	11 / 12.2			211	3.9
2021	4.0 / 5.5	17.5 / 21				
2030	5.5 / 7.5	25 / 30				
2042	7.5 / 11	33 / 42				
2056	11 / 15	47 / 56	300	180	202	6.0
2070	15 / 18.5	60 / 70	350	220	227	8.5
2082	18.5 / 22	75 / 82				9.0
2110	22 / 30	88 / 110	400	240	280	20
2138	30 / 37	115 / 138	450	255		35
2169	37 / 45	145 / 169	543	264	335	40
2211	45 / 55	180 / 211				
2257	55 / 75	215 / 257	700	312	420	80
2313	75 / 90	283 / 313				
2360	90 / 110	346 / 360	800	440	472	120
2415	110 / -	415 / -				



Ratings

380 - 480 VAC, 3-phase

Catalog code GA70C□□□□BBA	Max applicable motor power	Rated output current	Dimensions [mm]			Weight [kg]	
	HD / ND [kW]	HD / ND [A]	Height	Width	Depth		
4002	0.55 / 0.75	1.8 / 2.1	260	140	176	3.5	
4004	0.75 / 1.5	3.4 / 4.1					
4005	1.5 / 2.2	4.8 / 5.4					
4007	2.2 / 3.0	5.5 / 7.1					
4009	3.0 / 3.7	7.2 / 8.9			211		3.9
4012	3.7 / 5.5	9.2 / 11.9					
4018	5.5 / 7.5	14.8 / 17.5					
4023	7.5 / 11	18 / 23.4					
4031	11 / 15	24 / 31	300	180	202	6.0	
4038	15 / 18.5	31 / 38					
4044	18.5 / 22	39 / 44	350	220	227	7.5	
4060	22 / 30	45 / 59.6			246		
4075	30 / 37	60 / 74.9	400	240	280	16	
4089	37 / 45	75 / 89.2					
4103	45 / 55	91 / 103	450	255	335	35	
4140	55 / 75	112 / 140					
4168	75 / 90	150 / 168	543	264	420	40	
4208	90 / 110	180 / 208					
4250	110 / 132	216 / 250	700	312	472	80	
4296	132 / 160	260 / 296					
4371	160 / 200	304 / 371	800	440	480	120	
4389	200 / 220	371 / 389					
4453	220 / 250	414 / 453	1140	510	440	175	
4568	250 / 315	453 / 568					
4675	315 / 355	605 / 675	1370	760	440	363	
4810*	400 / 450	720 / 810					
4930*	450 / 500	810 / 930					
4H11*	500 / 560	930 / 1090					
4H12*	560 / 630	1090 / 1200				368	

* Catalog code: GA70CxxxxAAM

YASKAWA Europe GmbH

Philipp-Reis-Str. 6
65795 Hattersheim am Main
Germany

+49 6196 569-500
support@yaskawa.eu
www.yaskawa.eu.com

02/2025
YEU_INV_GA700_EN_v9

Specifications are subject to change without notice for ongoing product modifications and improvements. © YASKAWA Europe GmbH. All rights reserved.

YASKAWA