

YASKAWA

GA700 Series

AC Drive for Industrial Applications

Technical Manual

Model: GA70Cxxxxxxxxx
Type: 200 V Class: 0.55 to 110 kW
400 V Class: 0.55 to 630 kW



This Page Intentionally Blank

Table of Contents

i.	Preface and General Precautions	13
i.1	Receiving	14
	Glossary	14
	About Registered Trademarks	14
i.2	Using the Product Safely	16
	Explanation of Signal Words	16
	Section Safety	16
	Warning Label Content and Location	18
i.3	Warranty Information	19
	Exclusion of Liability	19
1.	Receiving	21
1.1	Section Safety	22
1.2	Verifying the Drive Model and Nameplate	23
	Nameplate	23
	How to Read the Model Number	23
1.3	Features and Advantages of Control Methods	27
2.	Mechanical Installation	31
2.1	Section Safety	32
2.2	Installation Environment	34
2.3	Installation Position and Clearances	35
	Install Single Drive	35
	Install Drives Side-by-Side	35
	External Heatsink Installation	36
2.4	Moving the Drive	38
	Using the Hanging Brackets to Move the Drive	38
	Instructions on Drive Suspension	38
2.5	Drive Watt Loss	40
	200 V Class	40
	400 V Class	41
2.6	Remove and Reattach the Keypad	44
	Remove the Keypad	44
	Reattach the Keypad	44
2.7	Install the Keypad in a Control Panel or Another Device	45
	Operate the Keypad from a Remote Location	45
	Connect the Keypad from a Remote Location	45
2.8	Removing/Reattaching Covers	50
	Removing/Reattaching the Cover Using Procedure A	50
	Removing/Reattaching the Cover Using Procedure B	51
2.9	Change the Drive Enclosure Type	55
2.10	Installation Methods	56

Standard Installation	56
External Heatsink	56
3. Electrical Installation	63
3.1 Section Safety	64
3.2 Electrical Installation	66
Standard Connection Diagram	66
3.3 Main Circuit Wiring	71
Motor and Main Circuit Connections	71
Configuration of Main Circuit Terminal Block	72
Main Circuit Terminal Functions	77
Wire Selection	78
Main Circuit Terminal and Motor Wiring	90
Protection of Main Circuit Terminals	93
6-Phase/12-Pulse Drives	94
3.4 Main Circuit Terminal Block Wiring Procedure	96
Wire the Main Circuit Terminal Block with Procedure A	96
Wire the Main Circuit Terminal Block with Procedure B	99
Wire the Main Circuit Terminal Block with Procedure C	101
Wire the Main Circuit Terminal Block with Procedure D	102
3.5 Control Circuit Wiring	104
Control Circuit Connection Diagram	104
Control Circuit Terminal Block Functions	105
Control Circuit Terminal Configuration	110
Wiring the Control Circuit Terminal	111
Switches and Jumpers on the Terminal Board	114
3.6 Control I/O Connections	115
Set Sinking Mode/Sourcing Mode	115
Pulse Train Output	115
Set Input Signals for MFAI Terminals A1 to A3	116
Set MFAI Terminal A3 to PTC Input	117
Set Output Signals for MFAO Terminals FM, AM	117
Switch ON Termination Resistor for MEMOBUS/Modbus Communications	118
3.7 Connect the Drive to a PC	119
3.8 External Interlock	120
Drive Ready	120
Interlock Circuit Example	120
3.9 Braking Resistor Installation	121
Install a Braking Resistor: ERF-Type	121
Install a Braking Resistor Unit: LKEB-Type	121
Install a Braking Unit Connection: CDBR-Type	122
Connect Braking Units in Parallel	128
Dynamic Braking Option Overload Protection	128
3.10 Drive Wiring Protection	130
Installing a Residual Current Monitoring/Detection (RCM/RCD)	130
Installing a Molded-Case Circuit Breaker (MCCB) or Residual Current Monitor/Device (RCM/RCD)	130
3.11 Dynamic Braking Option, Motor Protection	131
Install an Electromagnetic Contactor (MC) at the Input Side of the Drive	131
Installing a Thermal Overload Relay on the Drive Output	131
3.12 Improve the Power Factor	133
Connect an AC Reactor or a DC Reactor	133
3.13 Prevent Switching Surge	134
3.14 Decrease Noise	135
Connect a Noise Filter to the Input Side (Primary Side)	135

	Connect a Noise Filter to the Output Side (Secondary Side)	135
3.15	Protect the Drive during Failures	137
	Factory-Recommended Branch Circuit Protection for UL Listing	137
3.16	Wiring Checklist	141
3.17	Motor Application Precautions	143
	Precautions for Existing Standard Motors	143
	Precaution When You Use IE3 Premium Efficiency Motors	144
	Precautions for PM Motors	144
	Precautions for Specialized Motors	144
	Notes on the Power Transmission Mechanism	145
4.	Startup Procedure and Test Run	147
4.1	Section Safety	148
4.2	Keypad Components and Functions	149
	LCD Display	150
	Indicator LEDs and Drive Status	151
	Keypad Mode and Menu Displays	153
4.3	LED Status Ring	155
4.4	Start-up Procedures	157
	Flowchart A: Connect and Run the Motor with Minimum Setting Changes	157
	Sub-Chart A-1: Induction Motor Auto-Tuning and Test Run Procedure	158
	Sub-Chart A-2: PM Motor Auto-Tuning and Test Run Procedure	159
	Subchart A-3: EZ Open Loop Vector Control Test Run Procedure	160
4.5	Items to Check before Starting Up the Drive	161
	Check before Energizing the Drive	161
	Check after You Energize the Drive	161
	Make the Initial Settings	161
4.6	Keypad Operation	163
	Home Screen Display Selection	163
	Show the Monitor	164
	Set Custom Monitors	165
	Show Custom Monitors	166
	Set the Monitors to Show as a Bar Graph	166
	Show Monitors as Bar Graphs	168
	Set the Monitors to Show as Analog Gauges	168
	Display Monitors as an Analog Gauge	169
	Set Monitoring Items to be Shown as a Trend Plot	170
	Show Monitor Items as a Trend Plot	173
	Change Parameter Setting Values	174
	Examine User Custom Parameters	176
	Save a Backup of Parameters	177
	Write Backed-up Parameters to the Drive	178
	Verify Keypad Parameters and Drive Parameters	179
	Delete Parameters Backed Up to the Keypad	180
	Check Modified Parameters	181
	Restore Modified Parameters to Defaults	182
	Show Fault History	184
	Auto-Tuning the Drive	184
	Set the Keypad Language Display	186
	Set the Date and Time	187
	Set Parameters Using the Setup Wizard	189
	Disable the Initial Setup Screen	191
	Start Data Logging	191
	Configuring the Data Log Content	193
	Set Backlight to Automatically Turn OFF	199
	Show Information about the Drive	200
	Show Information about the Communication Option	201

	Write Automatically Backed-up Parameters to the Drive	202
4.7	Automatic Parameter Settings Optimized for Specific Applications (Application Presets)	204
4.8	Auto-Tuning	206
	Auto-Tuning for Induction Motors	206
	Auto-Tuning for PM Motors	207
	Auto-Tuning in EZ Open Loop Vector Control Method	209
	Control Tuning	210
	Precautions before Auto-Tuning	211
4.9	Test Run	215
	No-Load Test Run	215
	Do a No-Load Test Run	215
	Actual-Load Test Run	215
	Do an Actual-Load Test Run	216
4.10	Fine Tuning during Test Runs (Adjust the Control Function)	217
	V/f Control and Closed Loop V/f Control	217
	Open Loop Vector Control Method	218
	Closed Loop Vector Control Method	220
	Advanced Open Loop Vector Control Method	220
	Open Loop Vector Control for PM Motors	221
	Advanced Open Loop Vector Control Method for PM Motors	222
	Closed Loop Vector Control Method for PM	223
	EZ Open Loop Vector Control Method	223
4.11	Test Run Checklist	224
5.	Standards Compliance	227
5.1	Section Safety	228
5.2	European Standards	230
	CE Low Voltage Directive Compliance	230
	Electromagnetic Compatibility Regulations	249
5.3	United Kingdom Conformity Assessed Marking	259
5.4	UL Standards	260
	Area of Use	260
	Wire the Main Circuit Terminal Block	260
	UL Standards Compliance for DC Power Supply Input	280
	Low Voltage Wiring for Control Circuit Terminals	282
	Drive Motor Overload and Overheat Protection	282
5.5	China RoHS Compliance	288
	Information on Hazardous Substances in This Product	288
5.6	对应中国RoHS指令	289
	本产品中含有有害物质的信息	289
5.7	Safe Disable Input	290
	Safe Disable Specifications	290
	Notes	290
	Using the Safe Disable Function	291
6.	Network Communications	297
6.1	Section Safety	298
6.2	Field Bus Network Support	299
6.3	MEMOBUS/Modbus Communications	300
	Configure Master/Slave	300
	Communication Specifications	300
	Communication with the PLC	300
	MEMOBUS/Modbus Drive Operations	302
	Communications Timing	302

Message Format	303
Examples of Messages for Commands/Responses	305
Enter Command	309
Self-Diagnostics	310
Communications Data Table	311
Error Codes	331
7. Troubleshooting	333
7.1 Section Safety	334
7.2 Types of Faults, Minor Faults, Alarms, and Errors	336
7.3 List of Fault, Minor Fault, Alarm, and Error Codes	337
7.4 Fault	342
7.5 Minor Faults/Alarms	371
7.6 Parameter Setting Errors	382
7.7 Auto-Tuning Errors	387
7.8 Backup Function Operating Mode Display and Errors	392
7.9 Diagnosing and Resetting Faults	393
Fault and Power Loss Occur at the Same Time	393
Fault Occurs Without Power Loss	393
Fault Reset	393
7.10 Troubleshooting Without Fault Display	394
Typical Problems	394
The Parameter Settings Will Not Change	394
The Motor Does Not Rotate After Entering Run Command	395
The Motor Rotates in the Opposite Direction from the Run Command	396
The Motor Rotates in Only One Direction	396
The Motor Is Too Hot	396
The Correct Auto-Tuning Mode Is Not Available	397
The Motor Stalls during Acceleration or Accel/Decel Time Is Too Long	397
The Drive Frequency Reference Is Different than the Controller Frequency Reference Command	398
The Motor Speed Is Not Stable When Using a PM Motor	398
There Is Too Much Motor Oscillation and the Rotation Is Irregular	398
Deceleration Takes Longer Than Expected When Dynamic Braking Is Enabled	398
The Load Falls When a Brake Is Applied	399
There Is Audible Noise from the Drive or Motor Cables when You Energize the Drive	399
Residual Current Monitoring/Detection (RCM/RCD) Trips During Run	399
Motor Rotation Causes Unexpected Audible Noise from Connected Machinery	399
Motor Rotation Causes Oscillation or Hunting	400
PID Output Fault	400
The Starting Torque Is Not Sufficient	400
The Motor Rotates after the Drive Output Is Shut Off	400
The Output Frequency Is Lower Than the Frequency Reference	400
The Motor Is Making an Audible Noise	401
The Motor Will Not Restart after a Loss of Power	401
8. Periodic Inspection and Maintenance	403
8.1 Section Safety	404
8.2 Inspection	406
Recommended Daily Inspection	406
Recommended Periodic Inspection	406
8.3 Maintenance	408
Replaceable Parts	408
Part Replacement Guidelines	408
Monitors that Display the Lifespan of Drive Components	408

	Alarm Outputs for Maintenance Monitors	409
	Related Parameters	409
8.4	Replace Cooling Fans and Circulation Fans	410
	Cooling Fans and Circulation Fans by Drive Model	410
	Fan Replacement (Procedure A)	410
	Fan Replacement (Procedure B)	412
	Fan Replacement (Procedure C)	415
	Fan Replacement (Procedure D)	417
	Fan Replacement (Procedure E)	419
	Fan Replacement (Procedure F)	421
	Fan Replacement (Procedure G)	426
	Fan Replacement (Procedure H)	434
8.5	Replace the Drive	442
	About the Control Circuit Terminal Block	442
	Replace the Drive	442
8.6	Replace the Keypad Battery	447
8.7	Storage Guidelines	449
9.	Disposal	451
9.1	Section Safety	452
9.2	Disposal Instructions	453
	WEEE Directive	453
10.	Specifications	455
10.1	Section Safety	456
10.2	Drive Duty Modes	457
10.3	Model-Specific Specifications (200 V Class)	458
10.4	Model-Specific Specifications (400 V Class)	461
10.5	Drive Specifications	467
10.6	Drive Derating	470
	Carrier Frequency Settings and Rated Current Values	470
	Derating Depending on Ambient Temperature	474
	Altitude Derating	475
10.7	Drive Exterior and Mounting Dimensions	476
	Drive Models and Exterior and Mounting Dimensions	476
	IP00/IP20/UL Open Type	477
	IP20/UL Type1	487
10.8	Knock-Out Hole Dimensions (IP20/UL Type 1)	496
	Models and Dimensions of Knock-Out Hole	496
10.9	Peripheral Devices and Options	501
11.	Parameter List	505
11.1	Section Safety	506
11.2	How to Read the Parameter List	507
	Icons and Terms that Identify Parameters and Control Methods	507
11.3	Parameter Groups	508
11.4	A: Initialization Parameters	509
	A1: Initialization	509
	A2: User Parameters	510
11.5	b: Application	513
	b1: Operation Mode Selection	513
	b2: DC Injection Braking and Short Circuit Braking	514
	b3: Speed Search	515
	b4: Timer Function	517

	b5: PID Control	517
	b6: Dwell Function	521
	b7: Droop Control	521
	b8: Energy Saving	522
	b9: Zero Servo	523
11.6	C: Tuning	524
	C1: Accel & Decel Time	524
	C2: S-Curve Characteristics	524
	C3: Slip Compensation	525
	C4: Torque Compensation	526
	C5: Auto Speed Regulator (ASR)	527
	C6: Duty & Carrier Frequency	529
11.7	d: Reference Settings	530
	d1: Frequency Reference	530
	d2: Reference Limits	531
	d3: Jump Frequency	532
	d4: Frequency Ref Up/Down & Hold	532
	d5: Torque Control	533
	d6: Field Weakening /Forcing	533
	d7: Offset Frequency	534
11.8	E: Motor Parameters	535
	E1: V/f Pattern for Motor 1	535
	E2: Motor Parameters	536
	E3: V/f Pattern for Motor 2	537
	E4: Motor 2 Parameters	537
	E5: PM Motor Settings	538
	E9: Motor Setting	539
11.9	F: Options	540
	F1: PG Option Setup (Encoder)	540
	F2: Analog Input Option	543
	F3: Digital Input Option	543
	F4: Analog Monitor Option	544
	F5: Digital Output Option	545
	F6: Communication Options	545
	F7: Communication Options	549
11.10	H: Terminal Functions	554
	H1: Digital Inputs	554
	H2: Multi-function Digital Output	562
	H3: Analog Inputs	574
	H4: Analog Outputs	576
	H5: Modbus Communication	577
	H6: Pulse Train Input/Output	579
	H7: Virtual MFIO selection	579
11.11	L: Protection Functions	581
	L1: Motor Protection	581
	L2: Power Loss Ride Through	581
	L3: Stall Prevention	583
	L4: Speed Detection	584
	L5: Fault Restart	585
	L6: Torque Detection	586
	L7: Torque Limit	587
	L8: Drive Protection	588
	L9: Drive Protection 2	590
11.12	n: Special Adjustment	591
	n1: Hunting Prevention	591
	n2: Auto Freq Regulator (AFR)	591
	n3: High Slip/Overexcite Braking	592

n4: Adv Open Loop Vector Tune	592
n5: Feed Forward Control	593
n6: Online Tuning	594
n7: EZ Drive	594
n8: PM Motor Control Tuning	595
11.13 o: Keypad-Related Settings	598
o1: Keypad Display Selection	598
o2: Keypad Operation	600
o3: Copy Keypad Function	601
o4: Maintenance Monitors	602
o5: Log Function	603
11.14 q: DriveWorksEZ Parameters	605
q1-01 to qx-xx: Reserved for DriveWorksEZ	605
11.15 r: DWEZ Connection 1-20	606
r1-01 to r1-40: DriveWorksEZ Connection Parameters 1 to 20 (Upper / Lower)	606
11.16 T: Motor Tuning	607
T0: Tuning Mode Selection	607
T1: InductionMotor Auto-Tuning	607
T2: PM Motor Auto-Tuning	608
T3: ASR and Inertia Tuning	609
T4: EZ Tuning	609
11.17 U: Monitors	611
U1: Operation Status Monitors	611
U2: Fault Trace	613
U3: Fault History	615
U4: Maintenance Monitors	616
U5: PID Monitors	621
U6: Operation Status Monitors	622
U8: DriveWorksEZ Monitors	624
Ud: Control Monitors	626
11.18 Parameters that Change from the Default Settings with A1-02 [Control Method Selection]	627
11.19 Parameters that Change from the Default Settings with E3-01 [Motor 2 Control Mode Selection]	633
11.20 Parameters Changed by E1-03 [V/f Pattern Selection]	634
11.21 Defaults by Drive Model and Duty Rating ND/HD	637
Three-Phase 200 V Class	637
Three-Phase 400 V Class	644
12. Parameter Details	657
12.1 Section Safety	658
12.2 A: Initialization Parameters	659
A1: Initialization	659
A2: User Parameters	679
12.3 b: Application	680
b1: Operation Mode Selection	680
b2: DC Injection Braking and Short Circuit Braking	693
b3: Speed Search	696
b4: Timer Function	705
b5: PID control	707
b6: Dwell Function	722
b7: Droop Control	723
b8: Energy Saving	724
b9: Zero Servo	729
12.4 C: Tuning	731

	C1: Accel & Decel Time	731
	C2: S-Curve Characteristics	736
	C3: Slip Compensation	737
	C4: Torque Compensation	741
	C5: Automatic Speed Regulator (ASR: Automatic Speed Regulator)	743
	C6: Duty & Carrier Frequency	752
12.5	d: References	756
	d1: Frequency Reference	756
	d2: Reference Limits	762
	d3: Jump Frequency	763
	d4: Frequency Ref Up/Down & Hold	764
	d5: Torque Control	770
	d6: Field Weakening /Forcing	775
	d7: Offset Frequency	776
12.6	E: Motor Parameters	778
	E1: V/f Pattern for Motor 1	778
	E2: Motor 1 Parameters	785
	E3: V/f Pattern for Motor 2	788
	E4: Motor 2 Parameters	790
	E5: PM Motor Settings	793
	E9: Motor Setting	795
12.7	F: Options	798
	F1: Encoder Option Setup	798
	F2: Analog Input Option	806
	F3: Digital Input Option	807
	F4: Analog Monitor Option	811
	F5: Digital Output Option	814
	F6, F7: Communication Options	816
12.8	H: Terminal Functions	838
	H1: Digital Inputs	838
	Multi-Function Digital Input Setting Values	842
	H2: Multi-function Digital Output	861
	MFDO Setting Values	869
	H3: Analog Inputs	884
	Multi-Function Analog Input Terminal Settings	890
	H4: Analog Outputs	896
	H5: Memobus/Modbus Communication	899
	H6: Pulse Train Input/Output	903
	H7: Virtual MFIO Selection	907
12.9	L: Protection Functions	911
	L1: Motor Protection	911
	L2: Power Loss Ride Through	916
	L3: Stall Prevention	926
	L4: Speed Detection	936
	L5: Fault Restart	937
	L6: Torque Detection	940
	L7: Torque Limit	945
	L8: Drive Protection	948
	L9: Drive Protection 2	957
12.10	n: Special Adjustment	958
	n1: Hunting Prevention	958
	n2: Auto Freq Regulator (AFR)	960
	n3: High Slip Braking (HSB) and Overexcitation Braking	961
	n4: Adv Open Loop Vector Tune	964
	n5: Feed Forward Control	968
	n6: Online Tuning	970
	n7: EZ Drive	971
	n8: PM Motor Control Tuning	973

12.11	o: Keypad-Related Settings	981
	o1: Keypad Display Selection	981
	o2: Keypad Operation	988
	o3: Copy Function	992
	o4: Maintenance Mon Settings	994
	o5: Log Function	996
12.12	T: Auto-Tuning	1005
	T0: Tuning Mode Selection	1005
	T1: Induction Motor Auto-Tuning	1005
	T2: PM Motor Auto-Tuning	1008
	T3: ASR and Inertia Tuning	1011
	T4: EZ Tuning	1012
	Index	1014
	Revision History	1023

Preface and General Precautions

This chapter gives information about important safety precautions for the use of this product. Failure to obey these precautions can cause serious injury or death, or damage to the product or related devices and systems. Yaskawa must not be held responsible for any injury or equipment damage as a result of the failure to observe these precautions and instructions.

i.1	Receiving	14
i.2	Using the Product Safely	16
i.3	Warranty Information	19

i.1 Receiving









These instructions contain the information necessary to use the product correctly. Read and understand the safety information and precautions before you start to use the product.

◆ Glossary

Phrase	Definition
AOLV	Advanced Open Loop Vector Control
AOLV/PM	Advanced Open Loop Vector Control for Permanent Magnet Motors
CLV	Closed Loop Vector Control
CL-V/f	Closed Loop V/f Control
CLV/PM	Closed Loop Vector Control for Permanent Magnet Motors
Drive	YASKAWA AC Drive GA700
EDM	External Device Monitor
EZOLV	EZ Open Loop Vector Control
HD	Heavy Duty
IPM motor	Interior Permanent Magnet Motor
MFAI	Multi-Function Analog Input
MFAO	Multi-Function Analog Output
MFDI	Multi-Function Digital Input
MFDO	Multi-Function Digital Output
ND	Normal Duty
OLV	Open Loop Vector Control
OLV/PM	Open Loop Vector Control for Permanent Magnet Motors
PM motor	Permanent Magnet Synchronous Motor (generic name for IPM motors and SPM motors)
SIL	Safety Integrity Level
SPM motor	Surface Permanent Magnet Motor
V/f	V/f Control

■ Icons to Identify Screw Shapes

Table i.1 Icons to Identify Screw Shapes

Icon	Screw Shape	Icon	Screw Shape
	Phillips/slot combo (+/-)		Hex self-locking nut
	Slotted (-)		Hex socket cap (WAF: 5 mm)
	Minus (-)		Hex socket cap (WAF: 6 mm)
	Hex bolt (cross-slotted)		Hex socket cap (WAF: 8 mm)
	Hex bolt (slotted)		

◆ About Registered Trademarks

- CANopen is a registered trademark of CAN in Automation (CIA).
- CC-Link is a registered trademark of CC-Link Partner Association.
- DeviceNet is a registered trademark of Open DeviceNet Vendor Association, Inc. (ODVA).
- EtherCAT is a registered trademark of Beckhoff Automation GmbH.
- EtherNet/IP is a registered trademark of Open DeviceNet Vendor Association, Inc. (ODVA).
- LonWorks and LonTalk are registered trademarks of Echelon Corporation.
- MECHATROLINK-I, MECHATROLINK-II, and MECHATROLINK-III are registered trademarks of MECHATROLINK Members Association (MMA).

- Modbus is a registered trademark of Schneider Electric SA.
- PROFIBUS-DP and PROFINET are registered trademarks of PROFIBUS International.
- Other company names and product names in this document are trademarks or registered trademarks of the respective companies.

i.2 Using the Product Safely

◆ Explanation of Signal Words

⚠ WARNING

Read and understand this manual before you install, operate, or do maintenance on the drive. Install the drive as specified by this manual and local codes.

The symbols in this section identify safety messages in this manual. If you do not obey these safety messages, the hazards can cause serious injury, death, or damage to the products and related equipment and systems.

These identifier words categorize and emphasize important safety precautions in these instructions.

⚠ DANGER

This signal word identifies a hazard that will cause serious injury or death if you do not prevent it.

⚠ WARNING

This signal word identifies a hazard that can cause death or serious injuries if you do not prevent it.

⚠ CAUTION

This signal word identifies a hazard that can cause minor or moderate injuries if you do not prevent it.

NOTICE

This signal word identifies a property damage message that is not related to personal injury.

◆ Section Safety

General Precautions

- Some figures in the instructions include options and drives without covers or safety shields to more clearly show the inside of the drive. Replace covers and shields before operation. Use options and drives only as specified by the instructions.
- The figures in this manual are examples only. All figures do not apply to all products included in this manual.
- Yaskawa can change the products, specifications, and content of the instructions without notice to make the product and/or the instructions better.
- If you damage or lose these instructions, contact a Yaskawa representative or the nearest Yaskawa sales office on the rear cover of the manual, and tell them the document number on the front cover to order new copies.

⚠ DANGER

Do not ignore the safety messages in this manual.

If you ignore the safety messages in this manual, it will cause serious injury or death. The manufacturer is not responsible for injuries or damage to equipment.

Electrical Shock Hazard

Do not examine, connect, or disconnect wiring on an energized drive. Before servicing, disconnect all power to the equipment and wait for the time specified on the warning label at a minimum. The internal capacitor stays charged after the drive is de-energized. The charge indicator LED extinguishes when the DC bus voltage decreases below 50 Vdc. When all indicators are OFF, remove the covers before measuring for dangerous voltages to make sure that the drive is safe.

If you do work on the drive when it is energized, it will cause serious injury or death from electrical shock.

⚠ WARNING**Crush Hazard**

Test the system to make sure that the drive operates safely after you wire the drive and set parameters.

If you do not test the system, it can cause damage to equipment or serious injury or death.

Sudden Movement Hazard

Before you do a test run, make sure that the setting values for virtual input and output function parameters are correct. Virtual input and output functions can have different default settings and operation than wired input and output functions.

Incorrect function settings can cause serious injury or death.

Remove all personnel and objects from the area around the drive, motor, and machine and attach covers, couplings, shaft keys, and machine loads before you energize the drive.

If personnel are too close or if there are missing parts, it can cause serious injury or death.

Examine the I/O signals and internal sequence with the engineer who made the DriveWorksEZ program before you operate the drive.

If you do not know how the drive will operate, it can cause serious injury or death. When you use DriveWorksEZ to make custom programming, the drive I/O terminal functions change from factory settings and the drive will not operate as written in this manual.

Electrical Shock Hazard

Do not modify the drive body or drive circuitry.

Modifications to drive body and circuitry can cause serious injury or death, will cause damage to the drive, and will void the warranty. Yaskawa is not responsible for modifications of the product made by the user.

Only let approved personnel install, wire, maintain, examine, replace parts, and repair the drive.

If personnel are not approved, it can cause serious injury or death.

Do not remove covers or touch circuit boards while the drive is energized.

If you touch the internal components of an energized drive, it can cause serious injury or death.

After the drive blows a fuse or trips an RCM/RCD, do not immediately energize the drive or operate peripheral devices. Wait for the time specified on the warning label at a minimum and make sure that all indicators are OFF. Then check the wiring and peripheral device ratings to find the cause of the problem. If you do not know the cause of the problem, contact Yaskawa before you energize the drive or peripheral devices.

If you do not fix the problem before you operate the drive or peripheral devices, it can cause serious injury or death.

Damage to Equipment

Do not apply incorrect voltage to the main circuit of the drive. Operate the drive in the specified range of the input voltage on the drive nameplate.

Voltages that are higher than the permitted nameplate tolerance can cause damage to the drive.

Fire Hazard

Install sufficient branch circuit short circuit protection as specified by applicable codes and this manual. The drive is suitable for circuits that supply not more than 100,000 RMS symmetrical amperes, 240 Vac maximum (200 V Class), 480 Vac maximum (400 V Class).

Incorrect branch circuit short circuit protection can cause serious injury or death.

⚠ CAUTION**Crush Hazard**

Tighten terminal cover screws and hold the case safely when you move the drive.

If the drive or covers fall, it can cause moderate injury.

NOTICE

Use an inverter-duty motor or vector-duty motor with reinforced insulation and windings applicable for use with an AC drive.

If the motor does not have the correct insulation, it can cause a short circuit or ground fault from insulation deterioration.

Damage to Equipment

When you touch the drive and circuit boards, make sure that you observe correct electrostatic discharge (ESD) procedures.

If you do not follow procedures, it can cause ESD damage to the drive circuitry.

Do not do a withstand voltage test or use a megohmmeter or megger insulation tester on the drive.

These tests can cause damage to the drive.

Do not operate a drive or connected equipment that has damaged or missing parts.

You can cause damage to the drive and connected equipment.

Do not use steam or other disinfectants to fumigate wood for packaging the drive. Use alternative methods, for example heat treatment, before you package the components.

Gas from wood packaging fumigated with halogen disinfectants, for example fluorine, chlorine, bromine, iodine or DOP gas (phthalic acid ester), can cause damage to the drive.

◆ **Warning Label Content and Location**

The drive warning label is in the location shown in [Figure i.1](#). Use the drive as specified by this information.

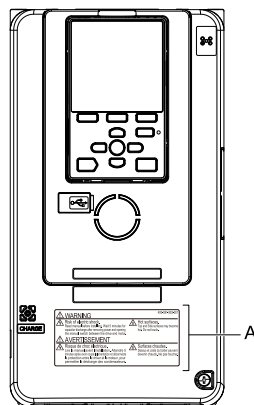
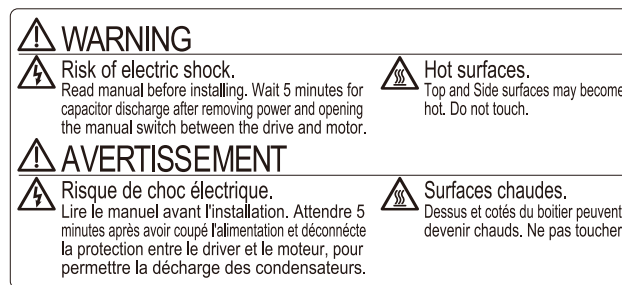

A - Warning label

Figure i.1 Warning Label Content and Location

i.3 Warranty Information

◆ Exclusion of Liability

- This product is not designed and manufactured for use in life-support machines or systems.
- Contact a Yaskawa representative or your Yaskawa sales representative if you are considering the application of this product for special purposes, such as machines or systems used for passenger cars, medicine, airplanes and aerospace, nuclear power, electric power, or undersea relaying.

⚠WARNING

Injury to Personnel

When you use this product in applications where its failure could cause the loss of human life, a serious accident, or physical injury, you must install applicable safety devices.

If you do not correctly install safety devices, it can cause serious injury or death.

Receiving

This chapter gives information about the different drive models and features, and how to examine the drive when you receive it.

1.1	Section Safety	22
1.2	Verifying the Drive Model and Nameplate	23
1.3	Features and Advantages of Control Methods	27

1.1 Section Safety

 **DANGER**

Do not ignore the safety messages in this manual.

If you ignore the safety messages in this manual, it will cause serious injury or death. The manufacturer is not responsible for injuries or damage to equipment.

1.2 Verifying the Drive Model and Nameplate

Please examine these items after receiving the drive:

- Examine the drive for damage. Immediately contact the shipping company if the drive is damaged. The Yaskawa warranty does not cover damage from shipping.
- Verify the drive model number to make sure that you received the correct model. Verify the model number in the "MODEL" section of the drive nameplate to make sure that you received the correct model.
- If you received a product different than you ordered or a product with a defect, contact Yaskawa or your nearest sales representative.

◆ Nameplate

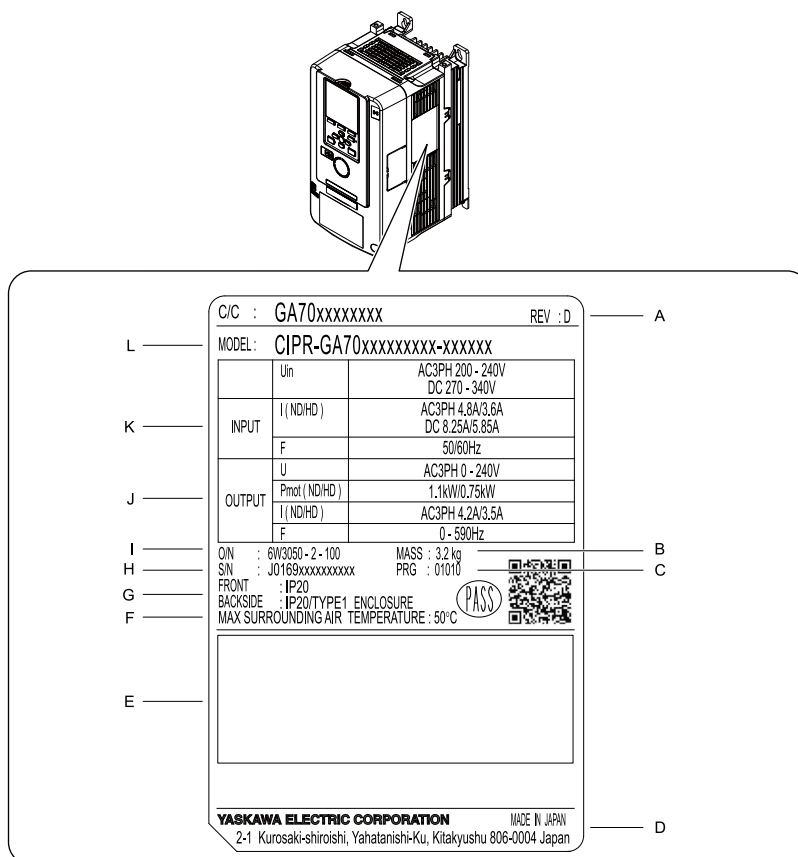

- | | |
|--|---------------------------|
| A - Hardware revision | G - Protection design |
| B - Weight | H - Serial number |
| C - Drive software version | I - Lot number |
| D - The address of the head office of Yaskawa Electric Corporation | J - Output specifications |
| E - Accreditation standards | K - Input specifications |
| F - Surrounding air temperature | L - Drive model |

Figure 1.1 Nameplate Information Example

◆ How to Read the Model Number

Use the information in [Figure 1.2](#) and [Table 1.1](#) to read the drive model numbers.

CIPR- GA70 A 2 004 A B A A - C A A A A A
 1 2 3 4 5 6 7 8 9 10 11 12 13 14 15

Figure 1.2 Drive Model

Table 1.1 Model Number Details

No.	Description
1	Drive
2	Product series
3	Region code <ul style="list-style-type: none"> • A: Japan • B: China • C: Europe • D: India • K: Korea • T: Asia (Singapore and Taiwan) • U: Americas
4	Input power supply voltage <ul style="list-style-type: none"> • 2: Three-Phase AC 200 V Class • 4: Three-Phase AC 400 V Class
5	Rated output current Note: Refer to the tables for the rated output current by model.
6	EMC noise filter <ul style="list-style-type: none"> • A: No internal EMC filter • B: Internal category C3 EMC filter
7	Enclosure protection design <ul style="list-style-type: none"> • A: IP00 • B: IP20 • W: IP55/UL Type 12 Heatsink External Mounting
8	Environmental specification (Reserved)
9	Design revision order
10	Control circuit terminal board (Reserved)
11	Option (connector CNS-A) (Reserved)
12	Option (connector CNS-B) (Reserved)
13	Option (connector CNS-C) (Reserved)
14	Keypad (Reserved)
15	Special applications (Reserved)

■ Rated Output Current

Table 1.2 to Table 1.4 give the rated output current values.

Note:

- These output current values are applicable for drives that operate at standard specifications.
- Derate the output current in applications that:
 - Increase the carrier frequency
 - Have high ambient temperature
 - Install drives side-by-side.
- Use C6-01 [*Normal / Heavy Duty Selection*] to select Normal Duty rating (ND) or Heavy Duty rating (HD).

Table 1.2 Three-Phase AC 200 V Class

Model	Heavy Duty Rating (HD) [C6-01 = 0] (Default)		Normal Duty Rating (ND) [C6-01 = 1]	
	Maximum Applicable Motor Output kW	Rated Output Current A	Maximum Applicable Motor Output kW	Rated Output Current A
2004	0.55	3.2	0.75	3.5
2006	0.75	5	1.1	6
2010	1.5	8	2.2	9.6
2012	2.2	11	3	12.2
2018	3	14	4	17.5
2021	4	17.5	5.5	21
2030	5.5	25	7.5	30

Model	Heavy Duty Rating (HD) [C6-01 = 0] (Default)		Normal Duty Rating (ND) [C6-01 = 1]	
	Maximum Applicable Motor Output kW	Rated Output Current A	Maximum Applicable Motor Output kW	Rated Output Current A
2042	7.5	33	11	42
2056	11	47	15	56
2070	15	60	18.5	70
2082	18.5	75	22	82
2110	22	88	30	110
2138	30	115	37	138
2169	37	145	45	169
2211	45	180	55	211
2257	55	215	75	257
2313	75	283	90	313
2360	90	346	110	360
2415	110	415	-	-

Table 1.3 Three-Phase AC 400 V Class (Input Voltage < 460 V)

Model	E1-01 [Input AC Supply Voltage] < 460			
	Heavy Duty Rating (HD) [C6-01 = 0] (Default)		Normal Duty Rating (ND) [C6-01 = 1]	
	Maximum Applicable Motor Output kW	Rated Output Current A	Maximum Applicable Motor Output kW	Rated Output Current A
4002	0.55	1.8	0.75	2.1
4004	1.1	3.4	1.5	4.1
4005	1.5	4.8	2.2	5.4
4007	2.2	5.5	3.0	7.1
4009	3.0	7.2	4.0	8.9
4012	4.0	9.2	5.5	11.9
4018	5.5	14.8	7.5	17.5
4023	7.5	18	11	23.4
4031	11	24	15	31
4038	15	31	18.5	38
4044	18.5	39	22	44
4060	22	45	30	59.6
4075	30	60	37	74.9
4089	37	75	45	89.2
4103	45	91	55	103
4140	55	112	75	140
4168	75	150	90	168
4208	90	180	110	208
4250	110	216	132	250
4296	132	260	160	296
4371	160	304	200	371
4389	200	371	220	389
4453	220	414	250	453
4568	250	453	315	568

Receiving

1

1.2 Verifying the Drive Model and Nameplate

Model	E1-01 [Input AC Supply Voltage] < 460			
	Heavy Duty Rating (HD) [C6-01 = 0] (Default)		Normal Duty Rating (ND) [C6-01 = 1]	
	Maximum Applicable Motor Output kW	Rated Output Current A	Maximum Applicable Motor Output kW	Rated Output Current A
4675	315	605	355	675
4810	400	720	450	810
4930	450	810	500	930
4H11	500	930	560	1090
4H12	560	1090	630	1200

Table 1.4 Three-Phase AC 400 V Class (Input Voltage \geq 460 V)

Model	E1-01 [Input AC Supply Voltage] \geq 460			
	Heavy Duty Rating (HD) [C6-01 = 0] (Default)		Normal Duty Rating (ND) [C6-01 = 1]	
	Maximum Applicable Motor Output HP	Rated Output Current A	Maximum Applicable Motor Output HP	Rated Output Current A
4002	3/4	1.6	1	2.1
4004	1	2.1	2	3.4
4005	2	3.4	3	4.8
4007	3	4.8	4	6.9
4009	4	6.9	5	7.6
4012	5	7.6	7 1/2	11
4018	7 1/2	11	10	14
4023	10	14	15	21
4031	15	21	20	27
4038	20	27	25	34
4044	25	34	30	40
4060	30	40	40	52
4075	40	52	50	65
4089	50	65	60	77
4103	60	77	75	96
4140	75	96	100	124
4168	100	124	125	156
4208	125	156	150	180
4250	150	180	200	240
4296	200	240	250	302
4371	250	302	300	361
4389	300	361	350	414
4453	350	414	400	477
4568	400	477	450	515
4675	-	-	-	-
4810	450	720	525	810
4930	525	810	600	930
4H11	600	930	675	1090
4H12	675	1090	750	1200

1.3 Features and Advantages of Control Methods

This drive has 9 available control methods from which you can select for different applications. [Table 1.5](#), [Table 1.6](#) and [Table 1.7](#) give information about the features of each control method.

Table 1.5 V/f and CL-V/f Features and Advantages of Control Methods

Control Method Selection	Open Loop V/f Control (V/f)	V/f Control with Encoder (CL-V/f)	Notes
Controlled Motor	Induction Motor		-
Parameter Settings	A1-02 = 0	A1-02 = 1	-
Basic Control	V/f	Closed loop V/f control with speed correction	-
Main Applications	General-purpose variable speed control to connect more than one motor to one drive.	High-precision speed control with encoders on machines	-
PG Option Card	Not necessary	Necessary (PG-B3 or PG-X3)	-
Maximum Output Frequency	590 Hz	400 Hz	-
Speed Control Range	1:40	1:40	This is the range of variable control. When you connect and operate motors in this mode, think about the increase in motor temperature.
Starting Torque	150% / 3 Hz	150% / 3 Hz	This is the motor torque that the drive can supply at low speed during start-up and the related output frequency (rotation speed). When a large quantity of torque is necessary at low speed, you must think about drive capacity and motor capacity.
Auto-Tuning *1	Rotational and Line-to-Line Resistance (usually not necessary)	Rotational and Line-to-Line Resistance (usually not necessary)	Automatically tunes electrical motor parameters.
Torque Limits *1	No	No	Controls maximum motor torque to prevent damage to machines and loads.
Torque Control *1	No	No	Directly controls motor torque to control tension and other parameters.
Droop Control *1	No	No	Sets load torque slip for motors. Distributes motor loads.
Zero Servo Control *1	No	No	Locks servos without an external position controller to prevent movement caused by external force.
Speed Search *1	Yes	-	Immediately estimates (or detects) motor speed and direction when coasting to a stop to quickly start-up the drive without stopping the motor.
Automatic Energy-saving Control *1	Yes	Yes	Automatically adjusts the voltage that the drive applies to the motor to maximize motor efficiency for small and large loads.
High Slip Braking (HSB) *1	Yes	Yes	Increases motor loss to let the motor decelerate faster than usual without a braking resistor. Motor characteristics have an effect on this function.
Feed Forward Control *1	No	No	Compensates effects of the system inertia to increase the speed precision when the load changes.
KEB Ride-Thru Function *1	Yes	Yes	Quickly and safely stops the motor during power loss and automatically starts operation at the previous speed when the drive applies power again without coasting the motor.
Overexcitation Deceleration *1	Yes	Yes	Sets the V/f higher than the setting value during deceleration to increase motor loss and decrease deceleration time.
Overvoltage Suppression Function *1 *2	Yes	Yes	Adjusts speed during regeneration to prevent overvoltage.

*1 Note these points when you use this function:

- When you can decouple the motor and machine for a test run, use Rotational Auto-Tuning. You must make adjustments to the control in the range where there is no vibration in the machine after Rotational Auto-Tuning.
- Motor loss increases during overexcitation braking and high-slip braking. Use a maximum braking frequency of 5% ED and a maximum braking time of 90 seconds. After you start high-slip braking, you cannot restart the motor until it stops. Use overexcitation braking to decelerate over a shorter time at a pre-determined speed.

*2 Do not use this function with hoist application.

1.3 Features and Advantages of Control Methods

Table 1.6 OLV, CLV and AOLV Features and Advantages of Control Methods

Control Method Selection	Open Loop Vector (OLV)	Closed Loop Vector (CLV)	Advanced Open Loop Vector Control ^{*1} (AOLV)	Notes
Controlled Motor	Induction Motor			-
Parameter Settings	A1-02 = 2 (Default)	A1-02 = 3	A1-02 = 4	-
Basic Control	Open Loop Current Vector Control	Closed Loop Current Vector Control	Open Loop Current Vector Control	-
Main Applications	<ul style="list-style-type: none"> General-purpose variable speed control Applications in which high performance is necessary without machine encoders 	Very high-performance control with motor encoders Example: High-precision speed control, torque control, torque limits	Sensorless vector control with speed control <ul style="list-style-type: none"> General-purpose variable speed control Applications in which high performance is necessary without machine encoders 	-
PG Option Card	Not necessary	Necessary (PG-B3 or PG-X3)	Not necessary	-
Maximum Output Frequency	590 Hz	400 Hz	120 Hz	-
Speed Control Range	1:200	1:1500	1:200	This is the range of variable control. When you connect and operate motors in this mode, think about the increase in motor temperature.
Starting Torque	200% / 0.3 Hz ^{*2}	200% / 0 min ⁻¹ ^{*2}	200% / 0.3 Hz ^{*2}	This is the motor torque that the drive can supply at low speed during start-up and the related output frequency (rotation speed). When a large quantity of torque is necessary at low speed, you must think about drive capacity and motor capacity.
Auto-Tuning ^{*3}	Rotational, Stationary, and Line-to-Line Resistance	Rotational, Stationary, and Line-to-Line Resistance	Rotational, Stationary, and Line-to-Line Resistance	Automatically tunes electrical motor parameters.
Torque Limits ^{*3}	Yes	Yes	Yes	Controls maximum motor torque to prevent damage to machines and loads.
Torque Control ^{*3}	No	Yes	Yes (Although NOT low speeds of approximately 10% or less)	Directly controls motor torque to control tension and other parameters.
Droop Control ^{*3}	No	Yes	Yes	Sets load torque slip for motors. Distributes motor loads.
Zero Servo Control ^{*3}	No	Yes	No	Locks servos without an external position controller to prevent movement caused by external force.
Speed Search ^{*3}	Yes	-	Yes	Immediately estimates (or detects) motor speed and direction when coasting to a stop to quickly start-up the drive without stopping the motor.
Automatic Energy-saving Control ^{*3}	Yes	Yes	No	Automatically adjusts the voltage that the drive applies to the motor to maximize motor efficiency for small and large loads.
High Slip Braking (HSB) ^{*3}	No	No	No	Increases motor loss to let the motor decelerate faster than usual without a braking resistor. Motor characteristics have an effect on this function.
Feed Forward Control ^{*3}	No	Yes	Yes	Compensates effects of the system inertia to increase the speed precision when the load changes.
KEB Ride-Thru Function ^{*3}	Yes	Yes	Yes	Quickly and safely stops the motor during power loss and automatically starts operation at the previous speed when the drive applies power again without coasting the motor.
Overexcitation Deceleration ^{*3}	Yes	Yes	Yes	Sets the V/f higher than the setting value during deceleration to increase motor loss and decrease deceleration time.
Overvoltage Suppression Function ^{*3} ^{*4}	Yes	Yes	Yes	Adjusts speed during regeneration to prevent overvoltage.

*1 If you operate the drive at a frequency lower than $n4-70$ [*Speed Command Comp @ Low Freq*] (default setting: 1.00 Hz), the motor can rotate at a frequency about 1/2 of $n4-70$. Set $E1-09 > 0$ [*Minimum Output Frequency > 0*] to not let the motor to rotate at a lower frequency than the $n4-70$ setting. When the frequency reference $\leq E1-09$, the drive output will turn OFF.

*2 Select the drive capacity and motor capacity correctly for the application.

*3 Note these points when you use this function:

- When you can decouple the motor and machine for a test run, use Rotational Auto-Tuning. You must make adjustments to the control in the range where there is no vibration in the machine after Rotational Auto-Tuning.
- For vector control, use a 1:1 drive to motor ratio. You cannot use vector control if you connect more than one motor to one drive. Select a drive capacity so that the motor rated current is 50% to 100% of the drive rated current. If the carrier frequency is too high, the drive rated current is derated.
- Motor loss increases during overexcitation braking and high-slip braking. Use a maximum braking frequency of 5% ED and a maximum braking time of 90 seconds. After you start high-slip braking, you cannot restart the motor until it stops. Use overexcitation braking to decelerate over a shorter time at a pre-determined speed.
- Acceleration and deceleration have priority over torque limits in Open Loop Vector Control during acceleration and deceleration (soft start changes). The drive will not operate until the speed is at the minimum frequency or the reverse direction of motor rotation when the motor speed decreases because of torque limits during constant speed control. Set L7-07 = 1 [Torque Limit during Accel/Decel = Proportional & Integral control] to enable torque limits during acceleration/deceleration (for winding applications).

*4 Do not use this function with hoist application.

Table 1.7 OLV/PM, AOLV/PM, CLV/PM and EZOLV Features and Advantages of Control Methods

Control Method Selection	PM Open Loop Vector Control (OLV/PM)	PM Advanced Open Loop Vector Control (AOLV/PM)	PM Closed Loop Vector Control (CLV/PM)	EZ Open Loop Vector Control (EZOLV)	Notes
Controlled Motor	PM motor			Induction Motors/PM Motors/SynRM (Synchronous Reluctance Motors)	-
Parameter Settings	A1-02 = 5	A1-02 = 6	A1-02 = 7	A1-02 = 8	-
Basic Control	PM Open Loop Vector Control (no speed controller)	PM Open Loop Current Vector Control (with speed controller)	PM Closed Loop Current Vector Control (with speed controller)	Open Loop Current Vector Control	-
Main Applications	<ul style="list-style-type: none"> • General-purpose variable speed control for PM motors • Applications in which a high level of responsiveness and accurate speed control are not necessary. 	<ul style="list-style-type: none"> • General-purpose variable speed control for IPM motors • Applications in which high-precision speed control and torque limits are necessary. 	Very high-performance PM motor control with motor encoders Example: Torque control and torque limits	Low-speed torque applications Example: Fans and pumps	-
PG Option Card	Not necessary	Not necessary	Necessary (PG-X3)	Not necessary	-
Maximum Output Frequency	590 Hz	400 Hz	400 Hz	120 Hz	-
Speed Control Range	1:20 AM	1:20 AM 1:100 *1 *2	1:1500	1:100	This is the range of variable control. When you connect and operate motors in this mode, think about the increase in motor temperature.
Starting Torque	100% / 5% speed	100% / 5% speed 200% / 0 min ⁻¹ *1 *3	200% / 0 min ⁻¹ *3	100% / 1% speed	This is the motor torque that the drive can supply at low speed during start-up and the related output frequency (rotation speed). When a large quantity of torque is necessary at low speed, you must think about drive capacity and motor capacity.
Auto-Tuning *4	Stationary, Stator Resistance, Rotational, High Frequency Injection	Stationary, Stator Resistance, Rotational, High Frequency Injection	Stationary, Stator Resistance, Z-phase, Rotational, High Frequency Injection	Line-to-Line Resistance	Automatically tunes electrical motor parameters.
Torque Limits *4	No	Yes	Yes	Yes	Controls maximum motor torque to prevent damage to machines and loads.
Torque Control *4	No	Yes *5	Yes	No	Directly controls motor torque to control tension and other parameters.
Droop Control *4	No	No	Yes	No	Sets load torque slip for motors. Distributes motor loads.
Zero Servo Control *4	No	No	Yes	No	Locks servos without an external position controller to prevent movement caused by external force.
Speed Search *4	Yes	Yes	Yes	Yes (Although NOT operation in the reverse direction of the Run command)	Immediately estimates (or detects) motor speed and direction when coasting to a stop to quickly start-up the drive without stopping the motor.
Automatic Energy-saving Control *4	No	Yes (IPM motors only)	Yes (IPM motors only)	Yes	Automatically adjusts the voltage that the drive applies to the motor to maximize motor efficiency for small and large loads.

Receiving

1

1.3 Features and Advantages of Control Methods

Control Method Selection	PM Open Loop Vector Control (OLV/PM)	PM Advanced Open Loop Vector (AOLV/PM)	PM Closed Loop Vector Control (CLV/PM)	EZ Open Loop Vector Control (EZOLV)	Notes
Controlled Motor	PM motor			Induction Motors/PM Motors/SynRM (Synchronous Reluctance Motors)	-
High Slip Braking (HSB) Activate	No (induction motor-specific function)	No (induction motor-specific function)	No (induction motor-specific function)	No	Increases motor loss to let the motor decelerate faster than usual without a braking resistor. Motor characteristics have an effect on this function.
Feed Forward Control *4	No	Yes	Yes	No	Compensates effects of the system inertia to increase the speed precision when the load changes.
KEB Ride-Thru Function *4	Yes	Yes	Yes	Yes	Quickly and safely stops the motor during power loss and automatically starts operation at the previous speed when the drive applies power again without coasting the motor.
Overexcitation Deceleration	No (induction motor-specific function)	No (induction motor-specific function)	No (induction motor-specific function)	No	Sets the V/f higher than the setting value during deceleration to increase motor loss and decrease deceleration time.
Overvoltage Suppression Function *4 *6	Yes	Yes	Yes	Yes	Adjusts speed during regeneration to prevent overvoltage.
Sensorless Zero Speed Control *4	No	Yes (IPM motors only)	-	No	Enables zero speed control using high frequency injection on IPM motors.

*1 Sets $n8-57 = 1$ [*HFI Overlap Selection = Enabled*]. When you use a non-Yaskawa PM motor, do Rotational Auto-Tuning.

*2 Speed control range of 1:100 is Instantaneous operation range. Correctly select the drive and motor capacity for continuous operation.

*3 Correctly select the drive and motor capacity.

*4 Note these points when you use this function:

- When you can decouple the motor and machine for a test run, use Rotational Auto-Tuning. You must make adjustments to the control in the range where there is no vibration in the machine after Rotational Auto-Tuning.
- For vector control, use a 1:1 drive to motor ratio. You cannot use vector control if you connect more than one motor to one drive. Select a drive capacity so that the motor rated current is 50% to 100% of the drive rated current. If the carrier frequency is too high, the drive rated current is derated.

*5 Torque control at zero speed is only available with IPM motors. To enable torque control with IPM motors at zero speed, set $n8-57 = 1$.

Note:

When you set $n8-35 = 1$ [*Initial Pole Detection Method = High Frequency Injection*] and $n8-57 = 1$, do High Frequency Injection Auto-Tuning.

*6 Do not use this function with hoist application.

Mechanical Installation

This chapter gives information about the correct environment and clearances to install the drive.

2.1	Section Safety	32
2.2	Installation Environment	34
2.3	Installation Position and Clearances	35
2.4	Moving the Drive	38
2.5	Drive Watt Loss	40
2.6	Remove and Reattach the Keypad	44
2.7	Install the Keypad in a Control Panel or Another Device	45
2.8	Removing/Reattaching Covers	50
2.9	Change the Drive Enclosure Type	55
2.10	Installation Methods	56

2.1 Section Safety

⚠ WARNING

Electrical Shock Hazard

Only let approved personnel install, wire, maintain, examine, replace parts, and repair the drive.
If personnel are not approved, it can cause serious injury or death.

Do not modify the drive body or drive circuitry.

Modifications to drive body and circuitry can cause serious injury or death, will cause damage to the drive, and will void the warranty. Yaskawa is not responsible for modifications of the product made by the user.

Fire Hazard

Do not put flammable or combustible materials on top of the drive and do not install the drive near flammable or combustible materials. Attach the drive to metal or other noncombustible material.

Flammable and combustible materials can start a fire and cause serious injury or death.

When you install the drive in an enclosure, use a cooling fan or cooler to decrease the temperature around the drive. Make sure that the intake air temperature to the drive is 50 °C (122 °F) or less for IP00/UL Open Type or IP20/UL Open Type drives, and 40 °C (104 °F) or less for IP20/UL Type 1 drives.

If the air temperature is too hot, the drive can become too hot and cause a fire and serious injury or death.

Crush Hazard

Only approved personnel can operate a crane or hoist to move the drive.

If unapproved personnel operate a crane or hoist, it can cause serious injury or death from falling equipment.

Before you hang the drive vertically, use screws to correctly attach the drive front cover and other drive components.

If you do not secure the front cover, it can fall and cause minor injury.

When you use a crane or hoist to lift the drive during installation or removal, prevent more than 1.96 m/s² (0.2 G) vibration or impact.

Too much vibration or impact can cause serious injury or death from falling equipment.

When you lift the drive during installation or removal, do not try to turn the drive over and do not ignore the hanging drive.

If you move a hanging drive too much or if you ignore it, the drive can fall and cause serious injury or death.

Use a crane or hoist to move large drives when necessary.

If you try to move a large drive without a crane or hoist, it can cause serious injury or death.

⚠ CAUTION

Crush Hazard

Tighten terminal cover screws and hold the case safely when you move the drive.

If the drive or covers fall, it can cause moderate injury.

NOTICE

Do not let unwanted objects, for example metal shavings or wire clippings, fall into the drive during drive installation. Put a temporary cover over the drive during installation. Remove the temporary cover before start-up.

Unwanted objects inside of the drive can cause damage to the drive.

Damage to Equipment

When you touch the drive and circuit boards, make sure that you observe correct electrostatic discharge (ESD) procedures.

If you do not follow procedures, it can cause ESD damage to the drive circuitry.

NOTICE

Install vibration-proof rubber on the base of the motor or use the frequency jump function in the drive to prevent specific frequencies that vibrate the motor.

Motor or system resonant vibration can occur in fixed speed machines that are converted to variable speed. Too much vibration can cause damage to equipment.

You can use the drive with an explosion-proof motor, but the drive is not explosion-proof. Install the drive only in the environment shown on the nameplate.

If you install the drive in a dangerous environment, it can cause damage to the drive.

Do not lift the drive with the covers removed.

If the drive does not have covers, you can easily cause damage to the internal parts of the drive.

2.2 Installation Environment

The installation environment is important for the lifespan of the product and to make sure that the drive performance is correct. Make sure that the installation environment aligns with these specifications.

Environment	Conditions
Area of Use	Indoors
Power Supply	Overvoltage Category III
Surrounding Air Temperature	IP00/UL Open Type: -10 °C to +50 °C (14 °F to 122 °F) IP20/UL Open Type: -10 °C to +50 °C (14 °F to 122 °F) IP20/UL Type 1: -10 °C to +40 °C (14 °F to 104 °F) IP55/UL Type 12 Heatsink External Mounting; front side: -10 °C to +50 °C (14 °F to 122 °F) IP55/UL Type 12 Heatsink External Mounting; back side: -10 °C to +40 °C (14 °F to 104 °F) <ul style="list-style-type: none"> • When you install the drive in an enclosure, use a cooling fan or air conditioner to keep the internal air temperature in the permitted range. • Do not let the drive freeze. • You can use IP00/UL Open Type drives and IP20/UL Open Type drives at a maximum of 60 °C (140 °F) when you derate the output current. • You can use IP20/UL Type 1 drives at a maximum of 50 °C (122 °F) when you derate the output current.
Humidity	95% RH or less Do not let condensation form on the drive.
Storage Temperature	-20 °C to +70 °C (-4 °F to +158 °F) (short-term temperature during transportation)
Surrounding Area	Pollution degree 2 or less Install the drive in an area without: <ul style="list-style-type: none"> • Oil mist, corrosive or flammable gas, or dust • Metal powder, oil, water, or other unwanted materials • Radioactive or flammable materials. • Harmful gas or fluids • Salt • Direct sunlight Keep wood and other flammable materials away from the drive.
Altitude	1000 m (3281 ft) Maximum Note: Derate the output current by 1% for each 100 m (328 ft) to install the drive in altitudes between 1000 m to 4000 m (3281 ft to 13123 ft). It is not necessary to derate the rated voltage in these conditions: <ul style="list-style-type: none"> • When you install the drive at 2000 m (6562 ft) or lower • When you install the drive between 2000 m to 4000 m (6562 ft to 13123 ft) and ground the neutral point on the power supply. Contact Yaskawa or your nearest sales representative if you will not ground the neutral point.
Vibration ^{*1}	<ul style="list-style-type: none"> • 10 Hz to 20 Hz: 2004 to 2415, 4002 to 4675: 1 G (9.8 m/s², 32.15 ft/s²) 4810 to 4H12: 0.6 G (5.9 m/s², 19.36 ft/s²) • 20 Hz to 55 Hz: 2004 to 2211, 4002 to 4168: 0.6 G (5.9 m/s², 19.36 ft/s²) 2257 to 2415, 4208 to 4H12: 0.2 G (2.0 m/s², 6.56 ft/s²)
Installation Orientation	Install the drive vertically for sufficient airflow to cool the drive.

*1 This drive passed the vibration test with a logarithmic sweep as specified by EN 60068-2-6 and JIS C60068-2-6. If the internal components of the drive vibrate too much, it can cause damage to the drive even when the vibration frequency is in the specification. If the drive components vibrate, improve the installation environment to decrease vibration.

- Put the motor on a rubber pad to decrease vibration.
- Reinforce the structure of the installation.

NOTICE: Do not let unwanted objects, for example metal shavings or wire clippings, fall into the drive during drive installation. Put a temporary cover over the drive during installation. Remove the temporary cover before start-up. Unwanted objects inside of the drive can cause damage to the drive.

Note:

Do not put drive peripheral devices, transformers, or other electronics near the drive. Shield the drive from electrical interference if components must be near the drive. Electrical interference can cause the drive or devices around the drive to function incorrectly.

2.3 Installation Position and Clearances

Install the drive vertically for sufficient airflow to cool the drive.

Note:

Contact Yaskawa or a Yaskawa representative for more information about installing drive models on their side.

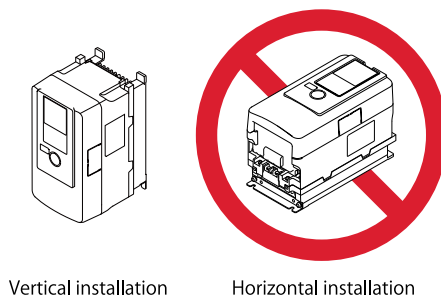
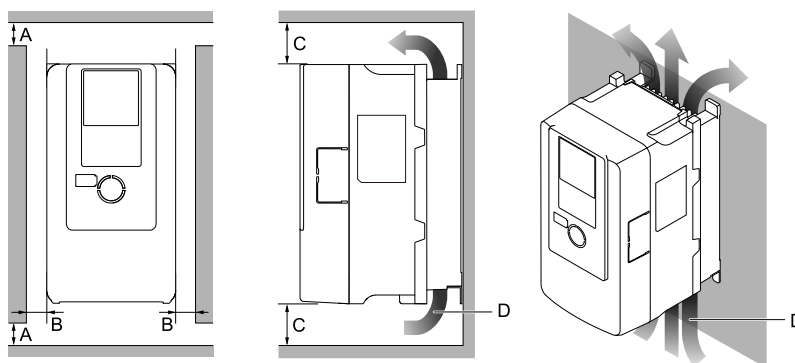

Figure 2.1 Installation Orientation

◆ Install Single Drive

Use the clearances specified in [Figure 2.2](#) to install the drive. Make sure that there is sufficient space for wiring and airflow to cool the drive.



A - 50 mm (2 in) minimum

B - 30 mm (1.2 in) minimum on each side

C - 120 mm (4.7 in) minimum above and below

D - Airflow direction

Figure 2.2 Installation Clearances for One Drive

◆ Install Drives Side-by-Side

You can install drive models 2004xB to 2082xB and 4002xB to 4044xB side-by-side.

When you install other drives side-by-side, make sure that you keep the necessary clearances between the drives for single drive installation.

To install these models side-by-side, make sure that there is sufficient space as shown in [Figure 2.3](#). Set $L8-35 = 1$ [*Installation Method Selection = Side-by-Side Mounting*].

Derate the output current to align with the ambient temperature. Refer to [Derating Depending on Ambient Temperature on page 474](#) for more information.

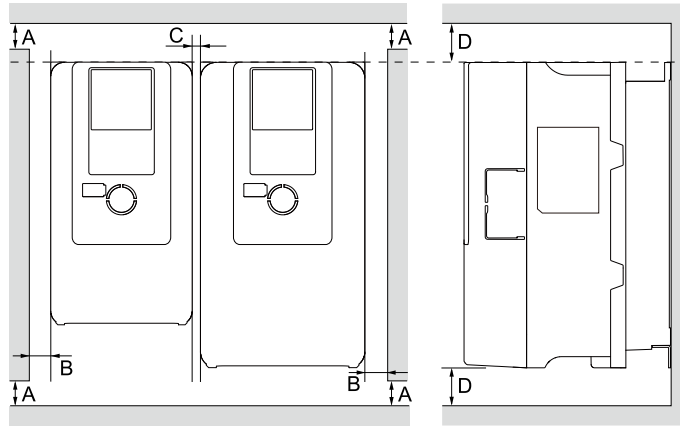

- A - 50 mm (2 in) minimum
- B - 30 mm (1.2 in) minimum on each side
- C - 2 mm (0.08 in) minimum between each drive
- D - 120 mm (4.7 in) minimum above and below

Figure 2.3 Installation Clearances for More than One Drive (Side-by-Side)

Note:

- When you do side-by-side installations of drives that have different dimensions, align the tops of the drives. This will make it easier to replace the cooling fans.
- Remove the top protective covers of all drives when you mount IP20/UL Type 1 drives side-by-side.

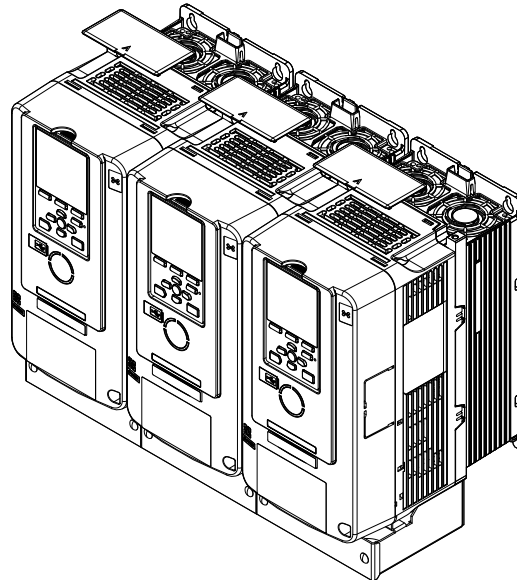

Figure 2.4 IP20/UL Type 1 Drives Installed Side-by-Side

◆ **External Heatsink Installation**

The optional External Heatsink Installation Kit will let you install the drive with the cooling fins, which are the main heat-dissipating component of the drive, external to the enclosure panel.

Table 2.1 shows the model numbers for the drive and the attachment. Contact Yaskawa or your nearest sales representative to make an order.

Table 2.1 External Heatsink Installation Kit (Optional)

Drive Model	Heatsink External Mounting Kit Model (No.)
2004 - 2042 4002 - 4023	900-193-209-001 (100-203-229)
2056 4031, 4038	900-193-209-002 (100-203-230)
2070, 2082 4044, 4060	900-193-209-003 (100-203-231)
2110 - 2415 4075 - 4H12	*1

- *1 When you install models 4075 to 4H12 with external heatsink installation, use the mounting brackets supplied with the drive. Optional attachments are not necessary.
- Refer to “External Heatsink Installation Kit Instruction Manual (TOxP C720600 03)” for more information about how to do an external heatsink installation. You can download manuals from the Yaskawa product and technical information website shown on the back cover of this manual.

2.4 Moving the Drive

Obey local laws and regulations when you move and install this product.

CAUTION! *Crush Hazard. Tighten terminal cover screws and hold the case safely when you move the drive. If the drive or covers fall, it can cause moderate injury.*

Drive Weight	Persons Necessary to Move the Drive
< 15 kg (33 lbs.)	1
≥ 15 kg (33 lbs.)	2 + using appropriate lifting equipment

Refer to [Using the Hanging Brackets to Move the Drive on page 38](#) for information about how to use suspension systems, wires, or hanging metal brackets to move the drive.

◆ Using the Hanging Brackets to Move the Drive

Use the hanging brackets attached to the drive to temporarily lift the drive when you install the drive to a control panel or wall or when you replace the drive. Do not let the drive stay vertically or horizontally suspended or move the drive over a long distance while it is suspended.

Before you install the drive, make sure that you read these precautions:

WARNING! *Crush Hazard. Before you hang the drive vertically, use screws to correctly attach the drive front cover and other drive components. If you do not secure the front cover, it can fall and cause minor injury.*

WARNING! *Crush Hazard. When you use a crane or hoist to lift the drive during installation or removal, prevent more than 1.96 m/s² (0.2 G) vibration or impact. Too much vibration or impact can cause serious injury or death from falling equipment.*

WARNING! *Crush Hazard. When you lift the drive during installation or removal, do not try to turn the drive over and do not ignore the hanging drive. If you move a hanging drive too much or if you ignore it, the drive can fall and cause serious injury or death.*

WARNING! *Crush Hazard. When you install the drive, do not hold the front cover. Install the drive with holding the heatsink. If you hold the front cover, the cover will come off and the drive will fall, then it can cause injury.*

◆ Instructions on Drive Suspension

The procedures in this section show you how to use wires to suspend the drive.

Model	Suspension Method
2110 - 2415 4075 - 4H12	Vertical Suspension
2138 - 2415 4089 - 4H12	Allows horizontal suspension

■ Vertical Suspension

To vertically suspend the drive with the hanging brackets, follow this procedure to lift the drive:

1. Put wire through the 2 holes in the hanging brackets.

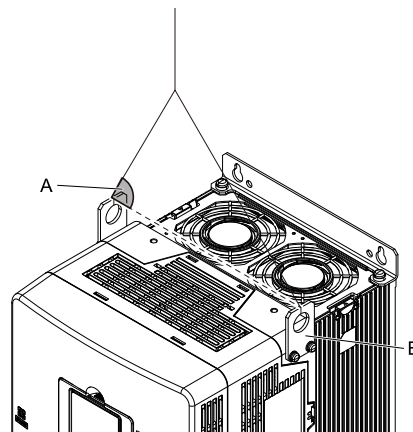

A - Suspension angle of at least 50 degrees

B - Hanging bracket (2)

Figure 2.5 Vertical Suspension

2. Use a crane to gradually wind up the wire. Visually make sure that there is sufficient tension in the wire, then lift the drive to its correct location.
3. Prepare the control panel for installation, then lower the drive.

Note:

When you lower the drive, stop before the drive touches the floor, then slowly lower it the remaining distance.

■ Horizontal Suspension

If a horizontal suspension is required in the installation environment, hang the drive through the following steps. Put the drive on the ground horizontally. Connect wires to the 4 hanging brackets and use a crane to lift the drive.

NOTICE: When you attach a horizontal lifting cable or chain to the drive, use a jig or pad between the wire and the drive. The wire can scratch the drive and cause damage to the drive.

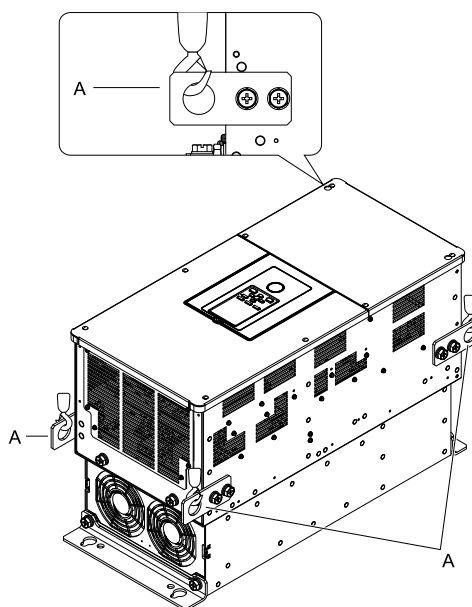

A - Hanging bracket (4)

Figure 2.6 Horizontal Suspension

2.5 Drive Watt Loss

◆ 200 V Class

Table 2.2 Drive Watt Loss (Heavy Duty)

Model	The rated output current A	Carrier Frequency kHz	Interior Unit Loss W	Cooling Fin Loss W	Total Loss W
2004	3.2	8	35	18	53
2006	5	8	37	26	63
2010	8	8	44	43	87
2012	11	8	50	61	111
2018	14	8	47	82	129
2021	17.5	8	56	105	161
2030	25	8	74	174	248
2042	33	8	88	183	271
2056	47	8	112	267	379
2070	60	8	145	373	518
2082	75	8	179	478	657
2110	88	8	155	563	718
2138	115	8	212	680	892
2169	145	5	275	820	1095
2211	180	5	314	991	1305
2257	215	5	398	1252	1650
2313	283	5	502	1643	2145
2360	346	5	582	1978	2560
2415	415	5	644	2359	3003

Table 2.3 Drive Watt Loss (Normal Duty)

Model	The rated output current A	Carrier Frequency kHz	Interior Unit Loss W	Cooling Fin Loss W	Total Loss W
2004	3.5	2	35	16	51
2006	6	2	38	25	63
2010	9.6	2	49	46	95
2012	12.2	2	56	62	118
2018	17.5	2	53	88	141
2021	21	2	75	125	200
2030	30	2	95	206	301
2042	42	2	129	227	356
2056	56	2	149	302	451
2070	70	2	177	403	580
2082	82	2	202	467	669
2110	110	2	192	631	823
2138	138	2	269	814	1083
2169	169	2	338	941	1279
2211	211	2	384	1131	1515
2257	257	2	519	1534	2053
2313	313	2	579	1794	2373

Model	The rated output current A	Carrier Frequency kHz	Interior Unit Loss W	Cooling Fin Loss W	Total Loss W
2360	360	2	655	2071	2726
2415	-	-	-	-	-

◆ 400 V Class

Table 2.4 Drive Watt Loss (Heavy Duty: < 460 V)

Model	The rated output current A	Carrier Frequency kHz	Interior Unit Loss W	Cooling Fin Loss W	Total Loss W
4002	1.8	8	38	15	53
4004	3.4	8	42	28	70
4005	4.8	8	46	37	83
4007	5.5	8	48	45	93
4009	7.2	8	37	61	98
4012	9.2	8	46	82	128
4018	14.8	8	65	140	205
4023	18	8	73	150	223
4031	24	8	101	211	312
4038	31	8	119	272	391
4044	39	8	148	354	502
4060	45	8	126	389	515
4075	60	8	165	527	692
4089	75	8	184	617	801
4103	91	8	237	779	1016
4140	112	5	300	956	1256
4168	150	5	486	1274	1760
4208	180	5	446	1432	1878
4250	216	5	558	1464	2022
4296	260	5	692	2061	2753
4371	304	5	824	2346	3170
4389	371	5	777	2212	2989
4453	414	2	963	2696	3659
4568	453	2	1086	3035	4121
4675	605	2	1328	3995	5323
4810	720	2	2009	5424	7433
4930	810	2	2030	6102	8132
4H11	930	2	2553	7092	9646
4H12	1090	2	2763	8197	10959

Table 2.5 Drive Watt Loss (Heavy Duty: ≥ 460 V)

Model	The rated output current A	Carrier Frequency kHz	Interior Unit Loss W	Cooling Fin Loss W	Total Loss W
4002	1.6	8	38	15	53
4004	2.1	8	39	19	58
4005	3.4	8	43	30	73
4007	4.8	8	46	43	89
4009	6.9	8	35	63	98
4012	7.6	8	39	71	110

2.5 Drive Watt Loss

Model	The rated output current A	Carrier Frequency kHz	Interior Unit Loss W	Cooling Fin Loss W	Total Loss W
4018	11	8	53	110	163
4023	14	8	59	120	179
4031	21	8	85	192	277
4038	27	8	99	245	344
4044	34	8	124	320	444
4060	40	8	115	361	476
4075	52	8	147	477	624
4089	65	8	165	566	731
4103	77	8	206	700	906
4140	96	5	265	849	1114
4168	124	5	400	1073	1473
4208	156	5	405	1300	1705
4250	180	5	454	1174	1628
4296	240	5	664	2021	2685
4371	302	5	843	2499	3342
4389	361	5	745	2161	2906
4453	414	2	1024	2835	3859
4568	477	2	1183	3329	4512
4675	-	-	-	-	-
4810	720	2	2036	5778	7814
4930	810	2	2120	6563	8683
4H11	930	2	2690	7708	10398
4H12	1090	2	2866	8917	11783

Table 2.6 Drive Watt Loss (Normal Duty: < 460 V)

Model	The rated output current A	Carrier Frequency kHz	Interior Unit Loss W	Cooling Fin Loss W	Total Loss W
4002	2.1	2	39	16	55
4004	4.1	2	44	33	77
4005	5.4	2	48	31	79
4007	7.1	2	52	44	96
4009	8.9	2	42	58	100
4012	11.9	2	57	84	141
4018	17.5	2	82	144	226
4023	23.4	2	108	185	293
4031	31	2	138	222	360
4038	38	2	145	270	415
4044	44	2	168	335	503
4060	59.6	2	157	444	601
4075	74.9	2	185	527	712
4089	89.2	2	212	665	877
4103	103	2	264	766	1030
4140	140	2	393	1126	1519
4168	168	2	574	1348	1922
4208	208	2	493	1465	1958
4250	250	2	686	1738	2424

Model	The rated output current A	Carrier Frequency kHz	Interior Unit Loss W	Cooling Fin Loss W	Total Loss W
4296	296	2	805	2155	2960
4371	371	2	1022	2553	3575
4389	389	2	867	2393	3260
4453	453	2	1086	3035	4121
4568	568	2	1429	3989	5418
4675	675	2	1526	4572	6098
4810	810	2	2314	6170	8484
4930	930	2	2330	7028	9358
4H11	1090	2	3003	8301	11304
4H12	1200	2	3169	9193	12362

Table 2.7 Drive Watt Loss (Normal Duty: ≥ 460 V)

Model	The rated output current A	Carrier Frequency kHz	Interior Unit Loss W	Cooling Fin Loss W	Total Loss W
4002	2.1	2	39	16	55
4004	3	2	42	25	67
4005	4.8	2	45	28	73
4007	6.9	2	50	42	92
4009	7.6	2	35	49	84
4012	11	2	49	76	125
4018	14	2	64	112	176
4023	21	2	87	158	245
4031	27	2	109	188	297
4038	34	2	116	234	350
4044	40	2	137	296	433
4060	52	2	133	379	512
4075	65	2	156	450	606
4089	77	2	180	569	749
4103	96	2	229	698	927
4140	124	2	334	982	1316
4168	156	2	481	1199	1680
4208	180	2	429	1275	1704
4250	240	2	648	1643	2291
4296	302	2	817	2257	3074
4371	361	2	975	2561	3536
4389	414	2	873	2422	3295
4453	477	2	1183	3329	4512
4568	515	2	1320	3697	5017
4675	-	-	-	-	-
4810	810	2	2385	6626	9011
4930	930	2	2465	7613	10078
4H11	1090	2	3162	9020	12182
4H12	1200	2	3236	9931	13167

2.6 Remove and Reattach the Keypad

NOTICE: You must remove the keypad before you remove or reattach the front cover. Before you reattach the keypad, make sure that you attach the front cover into position. If you keep the keypad connected to the drive when you remove the front cover, it can cause an unsatisfactory connection and incorrect operation.

◆ Remove the Keypad

1. Push down the tab on the top of the keypad, then pull the keypad forward and remove it from the drive.

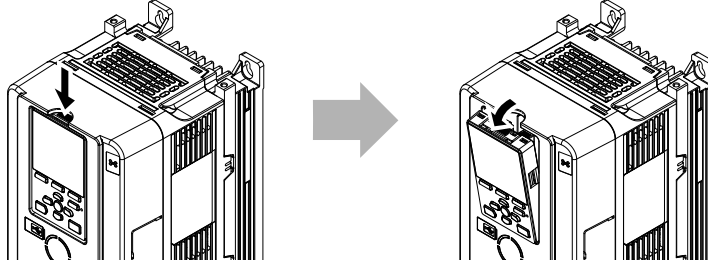
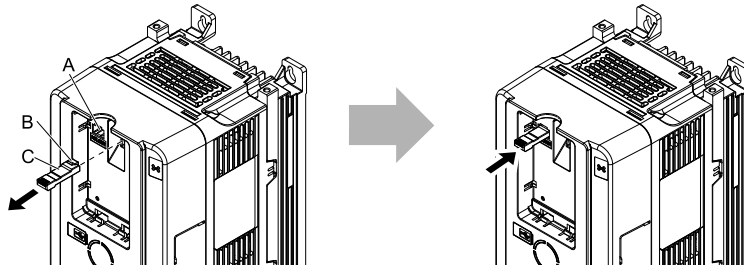

Figure 2.7 Remove the Keypad

2. Pull the keypad connector out from the drive horizontally, then put it in the holder.

Note:

Insert the end of the keypad connector that has the tab.



A - Holder
B - Hook

C - Keypad connector

Figure 2.8 Move the Keypad Connector to the Holder

◆ Reattach the Keypad

Insert the keypad connector to its initial position. Put the bottom of the keypad into position first, then carefully push on the top of the keypad until the hook clicks into place.

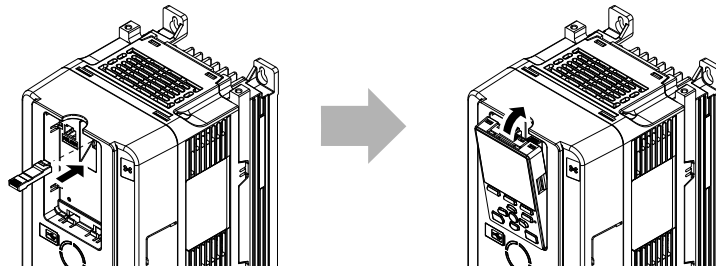

Figure 2.9 Reattach the Keypad

2.7 Install the Keypad in a Control Panel or Another Device

◆ Operate the Keypad from a Remote Location

You can remove the keypad from the drive and connect it to a remote control extension cable 3 m (9.8 ft) long to make operation easier when you cannot access the drive. It is not necessary to open or close the panel door to operate a drive that is in a control panel. To order optional accessories, contact Yaskawa or your nearest sales representative.

Name	Option Model	Intended Use
Keypad Remote Cable	WV001: 1 m (3.3 ft) WV003: 3 m (9.8 ft)	To connect the keypad and drive. This option is an RJ-45, 8-pin straight-through UTP CAT5e cable.
Installation Support Set A	900-192-933-001	To attach the keypad to the control panel. This option uses screws.
Installation Support Set B	900-192-933-002	To attach the keypad to the control panel. This option uses nut clamps. Use this option when weld studs are located in the control panel.

◆ Connect the Keypad from a Remote Location

Use the information in [Table 2.8](#) to install the keypad in the best location for your application.

Table 2.8 Keypad Installation Method

Installation Method	Features	Necessary Tools and Installation Support Sets
Outside of the control panel	Simplified installation is possible. Separate installation support sets are not necessary.	Phillips screwdriver #2 (M3)
Inside of the control panel	Keypad does not extend farther than the front of the control panel.	<ul style="list-style-type: none"> Phillips screwdriver #2 (M3, M4) Installation support set A (for mounting with screws, model: 900-192-933-001)
		<ul style="list-style-type: none"> Phillips screwdriver #2 (M3) Wrench (M4) Installation support set B (for mounting with nut clamp, model: 900-192-933-002)

Note:

Installation support sets are sold separately. If there are weld studs inside the control panel, use installation support set B. Contact Yaskawa or your nearest sales representative to make an order.

NOTICE: Do not let unwanted objects, for example metal shavings or wire clippings, fall into the drive during drive installation. Put a temporary cover over the drive during installation. Remove the temporary cover before start-up. Unwanted objects inside of the drive can cause damage to the drive.

■ External Dimensions of Keypad

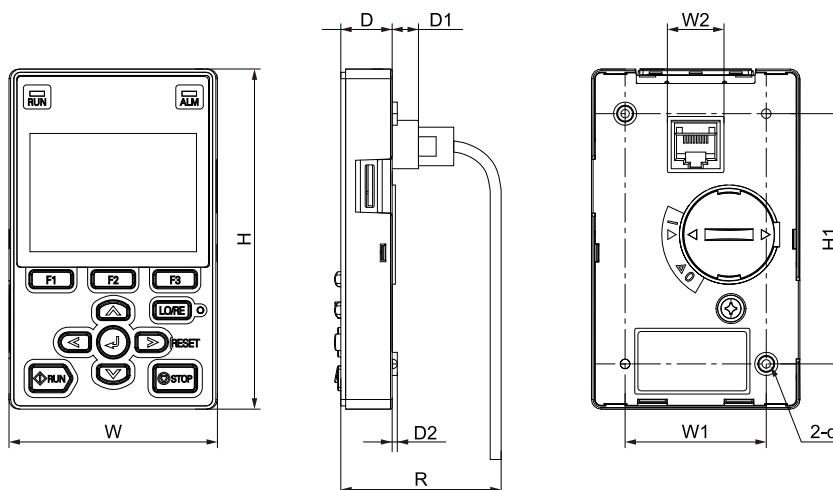

Figure 2.10 Exterior and Mounting Dimensions

Table 2.9 Exterior Dimensions (mm)

W	H	D	D1	D2	R *	W1	W2	H1	d
65	106	16	8.2	1.6	53.8	44	15	78	M3

2.7 Install the Keypad in a Control Panel or Another Device

*1 Minimum bending radius

■ Mount to the Outside of Control Panel

1. Use the dimensions in [Figure 2.11](#) and [Table 2.10](#) to cut an opening in the control panel for the keypad.

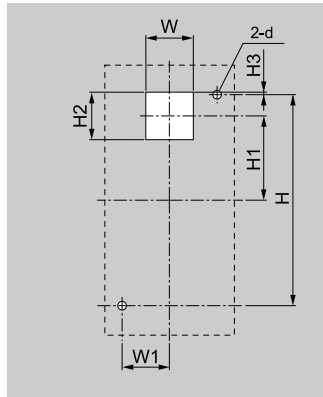

Figure 2.11 External/Face Mount Enclosure Panel Cut-Out Dimensions

Table 2.10 Panel Cut-Out Dimensions mm (in)

W	H	W1	H1	H2	H3	d
22 (0.89)	78 (3.07)	22 (0.89)	29 (1.14)	22 (0.89)	1 (0.04)	3.6 (0.14)

2. Remove the keypad and put the keypad connector in the holder on the front cover.

Note:

Insert the end of the keypad connector that has the tab.

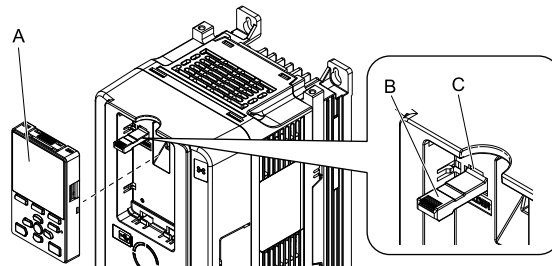

A - Keypad

B - Keypad connector

C - Holder

Figure 2.12 Remove the Keypad

3. Put the keypad on the outside of the control panel.

Use M3 screws (6 mm (0.2 in) depth cross-recessed pan head screws) to attach the keypad from the inside. Tighten the screws to a correct tightening torque:

- M3 screws: 0.49 N·m to 0.73 N·m (4.34 lbf·in to 6.46 lbf·in)

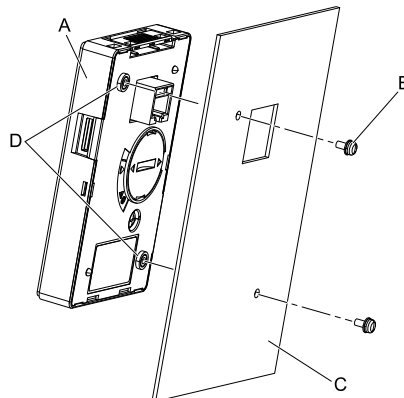

A - Keypad

B - M3 screws

C - Enclosure panel

D - Screw mounting holes

Figure 2.13 Mount to the Outside of Control Panel

- Use the extension cable to connect the drive to the keypad.

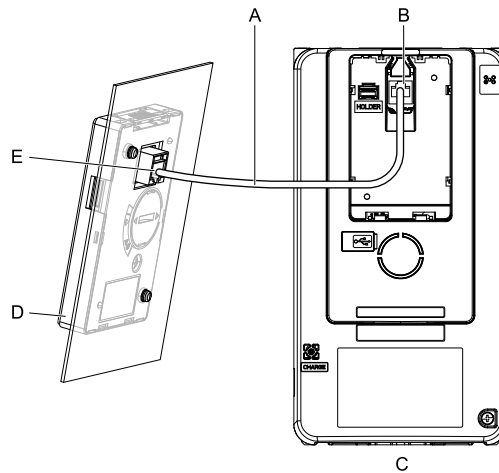

- A - Extension cable
- B - Communications connector
- C - Drive
- D - Keypad
- E - Cable connector

Figure 2.14 Connecting the Drive and Keypad with the Extension Cable

Mount to the Inside of Control Panel

Installation support sets A or B (sold separately) are necessary for Internal/Flush-Mount installation. To order optional accessories, contact Yaskawa or your nearest sales representative.

Note:

- The installation procedure and panel cut-out dimensions are the same for mounting brackets A and B.
- Use a gasket between the control panel and the keypad in environments with a large quantity of dust or other unwanted airborne material.

- Use the dimensions in Figure 2.15 and Table 2.11 to cut an opening in the control panel for the keypad.

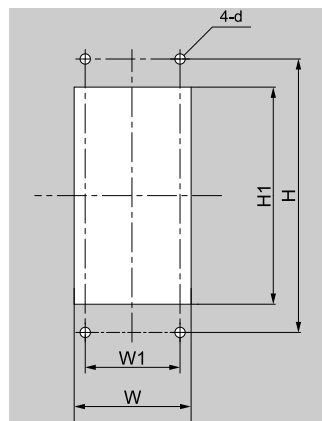

Figure 2.15 Panel Cut-Out Dimensions to Attach Inside Control Panel

Table 2.11 Panel Cut-Out Dimensions mm (in)

W	H	W1	H1	d
64 + 0.5 (2.52 + 0.02)	130 (5.12)	45 (1.77)	105 + 0.5 (4.13 + 0.02)	4.8 (0.12)

- Remove the keypad and put the keypad connector in the holder on the front cover.

Note:

Insert the end of the keypad connector that has the tab.

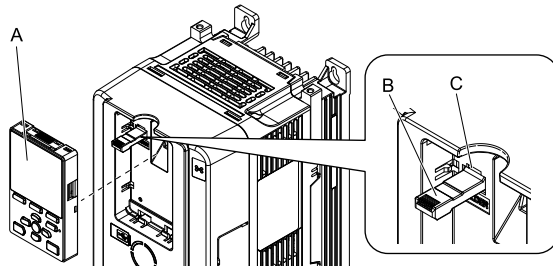

A - Keypad
B - Keypad connector

C - Holder

Figure 2.16 Remove the Keypad

3. Use the screws included with the mounting bracket, and attach the keypad to the mounting bracket. Use the screws included with the installation support set to attach it. Tighten the screws to a correct tightening torque:
 - M3 screws: 0.49 N·m to 0.73 N·m (4.34 lbf·in to 6.46 lbf·in)

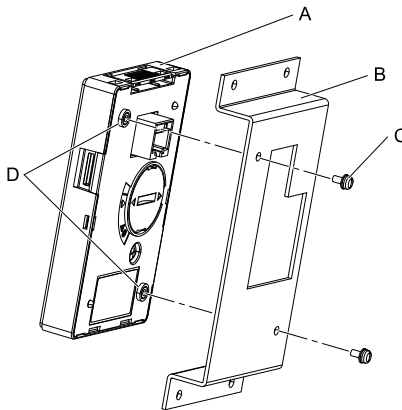

A - Keypad
B - Mounting bracket A

C - M3 screws
D - Screw mounting holes

Figure 2.17 Attach Keypad to Mounting Bracket

4. Put the mounting bracket that has the attached keypad in the control panel, and use the screws to attach it from the outside. Use the screws included with the installation support set to attach it. Tighten the screws to a correct tightening torque:
 - M4 screws: 0.98 N·m to 1.33 N·m (8.67 lbf·in to 11.77 lbf·in)

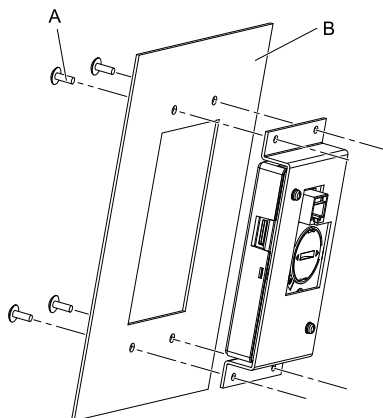

A - M4 screws

B - Enclosure panel

Figure 2.18 Mount Mounting Bracket to the Interior of the Control Panel

5. Use the extension cable to connect the drive to the keypad.

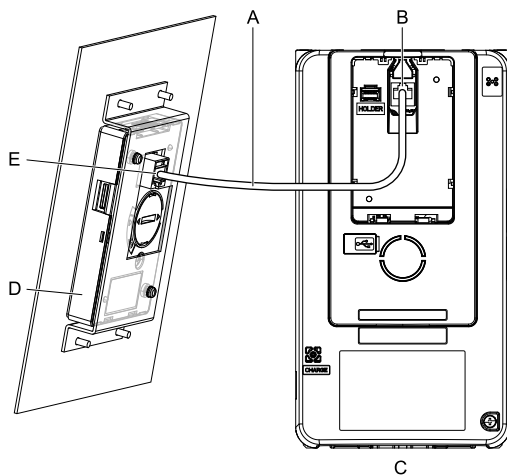

A - Extension cable

B - Communications connector

C - Drive

D - Keypad

E - Cable connector

Figure 2.19 Connecting the Drive and Keypad with the Extension Cable

2.8 Removing/Reattaching Covers

This section gives information about how to remove and reattach the front cover and terminal cover for wiring and inspection.

Different drive models have different procedures to remove and reattach the covers. Refer to [Table 2.12](#) for more information.

Table 2.12 Procedures to Remove Covers by Drive Model

Model	Procedure	Ref.
2004 - 2211 4002 - 4168	Procedure A	50
2257 - 2415 4208 - 4H12	Procedure B	51

◆ Removing/Reattaching the Cover Using Procedure A

DANGER! Electrical Shock Hazard. Do not examine, connect, or disconnect wiring on an energized drive. Before servicing, disconnect all power to the equipment and wait for the time specified on the warning label at a minimum. The internal capacitor stays charged after the drive is de-energized. The charge indicator LED extinguishes when the DC bus voltage decreases below 50 Vdc. When all indicators are OFF, remove the covers before measuring for dangerous voltages to make sure that the drive is safe. If you do work on the drive when it is energized, it will cause serious injury or death from electrical shock.

■ Remove the Front Cover

1. Remove the keypad and the keypad connector, then insert the end of the keypad connector that has the tab into the keypad connector holder on the front cover.

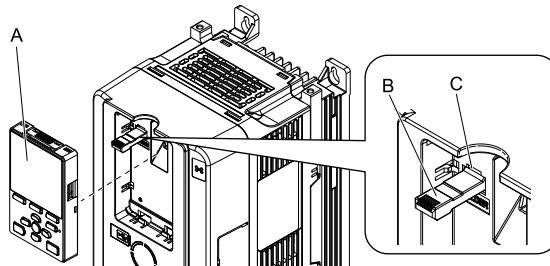

A - Keypad

B - Keypad connector

C - Holder

Figure 2.20 Remove the Keypad and Keypad Connector

2. Loosen the front cover screws.

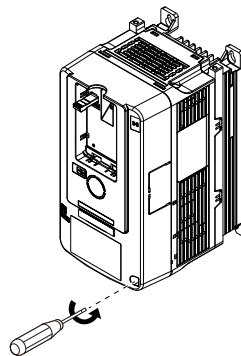

Figure 2.21 Loosen the Front Cover Screws

3. Push on the tab in the side of the front cover then pull the front cover forward to remove it from the drive.

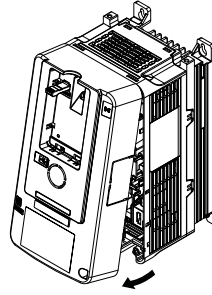

Figure 2.22 Remove the Front Cover

■ Install the Front Cover

1. Wire the drive and other peripheral devices.
2. Reverse the steps to reattach the cover.

Note:

- Wire the grounding terminals first, main circuit terminals next, and control circuit terminals last.
- Make sure that you do not pinch wires or signal lines between the front cover and the drive before you reattach the cover.
- Tighten the screws to a tightening torque of 0.98 N·m to 1.33 N·m (8.67 lbf·in to 11.77 lbf·in).

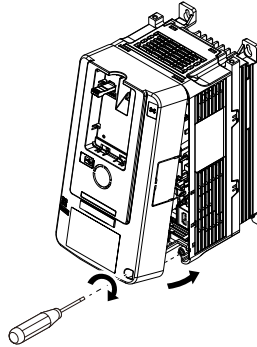

Figure 2.23 Install the Front Cover

3. Reattach the keypad to the original position.

◆ Removing/Reattaching the Cover Using Procedure B

DANGER! Electrical Shock Hazard. Do not examine, connect, or disconnect wiring on an energized drive. Before servicing, disconnect all power to the equipment and wait for the time specified on the warning label at a minimum. The internal capacitor stays charged after the drive is de-energized. The charge indicator LED extinguishes when the DC bus voltage decreases below 50 Vdc. When all indicators are OFF, remove the covers before measuring for dangerous voltages to make sure that the drive is safe. If you do work on the drive when it is energized, it will cause serious injury or death from electrical shock.

■ Remove the Front Cover

1. Remove the terminal cover, keypad, and keypad connector, then insert the end of the keypad connector that has the tab into the keypad connector holder on the front cover.

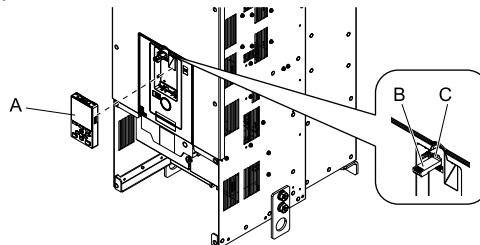

A - Keypad

B - Keypad connector

C - Connector holder

Figure 2.24 Remove the Terminal Cover, Keypad, and Keypad Connector

- Loosen the front cover screws.

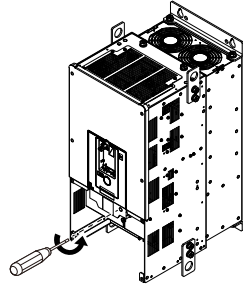
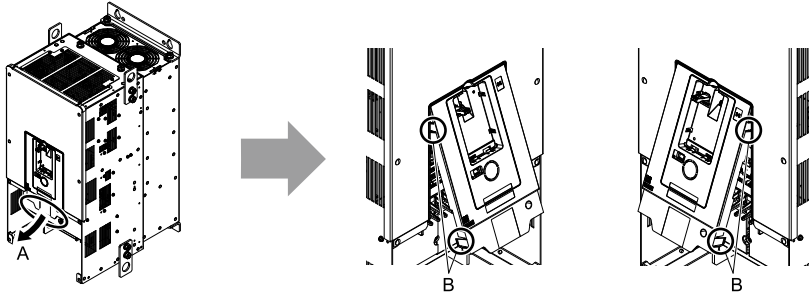

Figure 2.25 Loosen the Front Cover Screws

- Push on the four tabs found on each side of the front cover, then pull the front cover forward to remove it from the drive.



A - Pull forward to remove the front cover.

B - Unhook the tabs found on the sides of the front cover.

Figure 2.26 Pull Forward to Remove the Front Cover

- Remove the front cover from the drive.

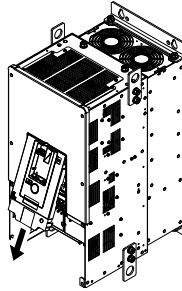

Figure 2.27 Remove the Front Cover

■ Reattach the Front Cover

Wire the drive and other peripheral devices then reattach the front cover.

Note:

Wire the grounding terminals first, main circuit terminals next, and control circuit terminals last.

- Move the front cover to connect the hooks at the top of the front cover to the drive.

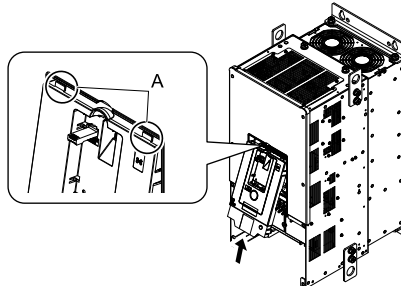

A - Hooks

Figure 2.28 Reattach the Front Cover

2. Move the front cover until it clicks into position while pushing on the hooks on the left and right sides of the front cover.

Note:

Make sure that you do not pinch wires or signal lines between the front cover and the drive before you reattach the cover.

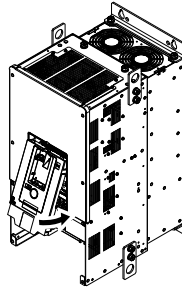

Figure 2.29 Reattach the Front Cover

3. Reattach the keypad to the original position.

■ Remove the Terminal Cover

1. Loosen the screws on the terminal cover, then pull down on the cover.

CAUTION! *Crush Hazard. Loosen the cover screws. Do not fully remove them. If you fully remove the cover screws, the terminal cover can fall and cause moderate injury.*

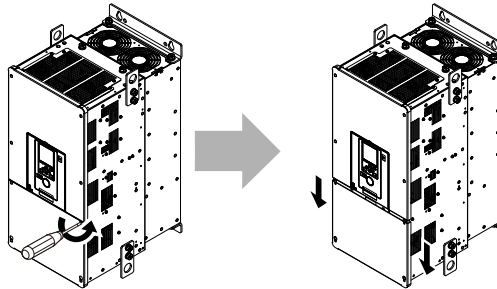

Figure 2.30 Loosen the Terminal Cover Mounting Screws

2. Pull the terminal cover away from the drive.

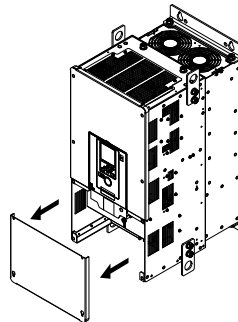

Figure 2.31 Remove the Terminal Cover

■ Reattach the Terminal Cover

Wire the drive and other peripheral devices then reattach the terminal cover.

Note:

- Wire the grounding terminals first, main circuit terminals next, and control circuit terminals last.
- Make sure that you do not pinch wires or signal lines between the wiring cover and the drive before you reattach the cover.
- Tighten the screws to a correct tightening torque:
 - Models 2257 to 2415: 0.98 N·m to 1.33 N·m (8.67 lbf·in to 11.77 lbf·in)
 - Models 4208 to 4675: 0.98 N·m to 1.33 N·m (8.67 lbf·in to 11.77 lbf·in)
 - Models 4810 to 4H12: 1.96 N·m to 2.53 N·m (17.35 lbf·in to 22.39 lbf·in)

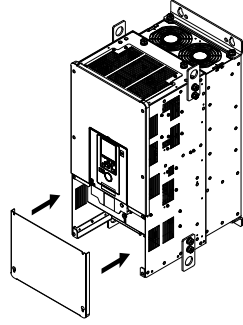

Figure 2.32 Reattach the Terminal Cover

2.9 Change the Drive Enclosure Type

The enclosure type of the drive is IP20/UL Open Type. You must install a UL Type 1 kit to change the enclosure type to an enclosed, IP20/UL Type 1.

Install the kit before you wire the drive.

Different drives use different UL Type 1 kits. Refer to [Table 2.13](#) to find the kit for your drive. Contact Yaskawa or your nearest sales representative for more information about UL Type 1 kits.

Table 2.13 UL Type 1 Kits by Drive Model

Model	Option Model
2004, 2006, 2010, 2012, 2018, 2021, 2030, 2042 4002, 4004, 4005, 4007, 4009, 4012, 4018, 4023	900-192-121-001
2056 4031, 4038	900-192-121-002
2070 4044, 4060	900-192-121-003
2082	900-192-121-004
2110 4075	900-192-121-005
2138 4089, 4103	900-192-121-006
2169 4140, 4168	900-192-121-007
2211	900-192-121-008
2257, 2313 4208, 4250, 4296	900-192-121-009
2360, 2415 4371, 4389	900-192-121-010
4453, 4568, 4675	900-192-121-011

2.10 Installation Methods

The drive installation methods include standard installation and external heatsink installation.

◆ Standard Installation

Refer to *Drive Exterior and Mounting Dimensions on page 476* for more information about external dimensions and installation methods.

◆ External Heatsink

Refer to [Table 2.15](#), [Table 2.16](#), and [Table 2.17](#) for the panel cut-out dimensions for external heatsink installations. An attachment is necessary to install drive models smaller than 2082 (200 V class) and 4060 (400 V class) with the heatsink outside of the panel.

Note:

- The exterior mounting dimensions and installation dimensions for a standard installation are different than the dimensions for an external heatsink installation.
- The shaded parts of the panel cut-out dimensions are the gasket dimensions. Make sure that the gasket is not smaller than the specified dimension.

Table 2.14 External Heatsink Mount Kit

Drive Model	Model
2004 - 2042 4002 - 4023	900-193-209-001
2056 4031, 4038	900-193-209-002
2070, 2082 4044, 4060	900-193-209-003
2110 - 2415 4075 - 4H12	-

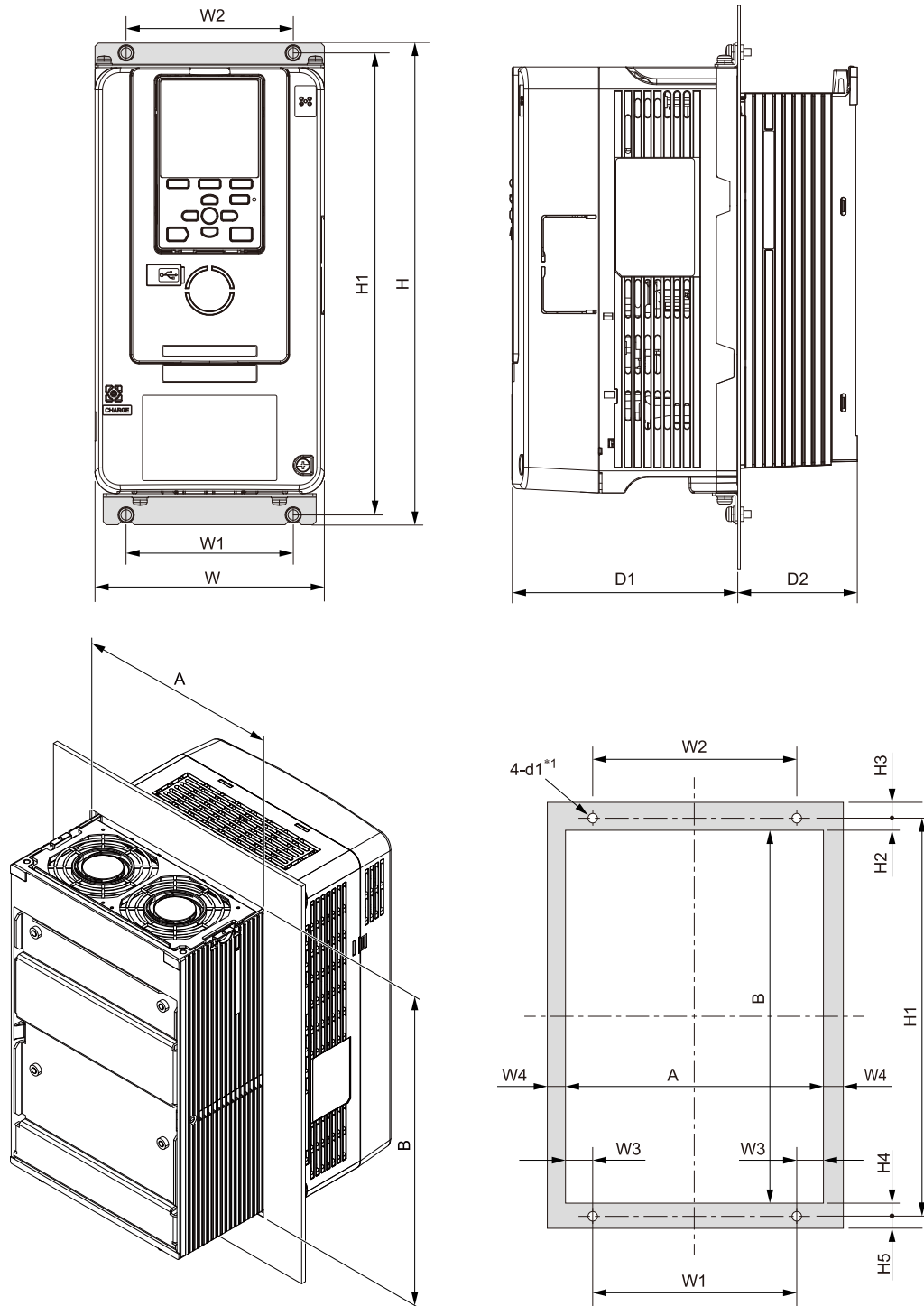

Figure 2.33 Panel Cut-Out Dimensions

*1 Make threads inside the mounting screw holes on the panel.

Table 2.15 Panel Cut-Out Dimensions (200 V Class)

Model	Dimensions mm (in)															
	W	H	D1	D2	W1	W2	W3	W4	H1	H2	H3	H4	H5	A	B	d1
2004 *1	140 (5.51)	294 (11.57)	138 (5.43)	38 (1.50)	102 (4.02)	102 (4.02)	16 (0.63)	3 (0.12)	282 (11.10)	23 (0.91)	6 (0.24)	26 (1.02)	6 (0.24)	134 (5.28)	233 (9.17)	M5
2006 *1	140 (5.51)	294 (11.57)	138 (5.43)	38 (1.50)	102 (4.02)	102 (4.02)	16 (0.63)	3 (0.12)	282 (11.10)	23 (0.91)	6 (0.24)	26 (1.02)	6 (0.24)	134 (5.28)	233 (9.17)	M5
2010 *1	140 (5.51)	294 (11.57)	138 (5.43)	38 (1.50)	102 (4.02)	102 (4.02)	16 (0.63)	3 (0.12)	282 (11.10)	23 (0.91)	6 (0.24)	26 (1.02)	6 (0.24)	134 (5.28)	233 (9.17)	M5
2012 *1	140 (5.51)	294 (11.57)	138 (5.43)	38 (1.50)	102 (4.02)	102 (4.02)	16 (0.63)	3 (0.12)	282 (11.10)	23 (0.91)	6 (0.24)	26 (1.02)	6 (0.24)	134 (5.28)	233 (9.17)	M5

2.10 Installation Methods

Model	Dimensions mm (in)															
	W	H	D1	D2	W1	W2	W3	W4	H1	H2	H3	H4	H5	A	B	d1
2018 *J	140 (5.51)	294 (11.57)	138 (5.43)	73 (2.87)	102 (4.02)	102 (4.02)	16 (0.63)	3 (0.12)	282 (11.10)	23 (0.91)	6 (0.24)	26 (1.02)	6 (0.24)	134 (5.28)	233 (9.17)	M5
2021 *J	140 (5.51)	294 (11.57)	138 (5.43)	73 (2.87)	102 (4.02)	102 (4.02)	16 (0.63)	3 (0.12)	282 (11.10)	23 (0.91)	6 (0.24)	26 (1.02)	6 (0.24)	134 (5.28)	233 (9.17)	M5
2030 *J	140 (5.51)	294 (11.57)	138 (5.43)	73 (2.87)	102 (4.02)	102 (4.02)	16 (0.63)	3 (0.12)	282 (11.10)	23 (0.91)	6 (0.24)	26 (1.02)	6 (0.24)	134 (5.28)	233 (9.17)	M5
2042 *J	140 (5.51)	294 (11.57)	138 (5.43)	73 (2.87)	102 (4.02)	102 (4.02)	16 (0.63)	3 (0.12)	282 (11.10)	23 (0.91)	6 (0.24)	26 (1.02)	6 (0.24)	134 (5.28)	233 (9.17)	M5
2056 *J	180 (7.09)	329 (12.95)	134 (5.28)	68 (2.68)	140 (5.51)	140 (5.51)	17 (0.67)	3 (0.12)	318 (12.52)	23.5 (0.93)	5 (0.20)	24.5 (0.97)	6 (0.24)	174 (6.85)	270 (10.63)	M5
2070 *J	220 (8.66)	384 (15.12)	140 (5.51)	87 (3.43)	192 (7.56)	192 (7.56)	11 (0.43)	3 (0.12)	371 (14.61)	27 (1.06)	7 (0.28)	25 (0.98)	6 (0.24)	214 (8.43)	319 (12.56)	M6
2082 *J	220 (8.66)	384 (15.12)	140 (5.51)	87 (3.43)	192 (7.56)	192 (7.56)	11 (0.43)	3 (0.12)	371 (14.61)	27 (1.06)	7 (0.28)	25 (0.98)	6 (0.24)	214 (8.43)	319 (12.56)	M6
2110	240 (9.45)	400 (15.75)	166 (6.54)	114 (4.49)	195 (7.68)	204 (8.03)	14.5 (0.57)	8 (0.32)	385 (15.16)	19.5 (0.77)	7.5 (0.30)	19.5 (0.77)	7.5 (0.30)	224 (8.82)	346 (13.62)	M6
2138	255 (10.04)	450 (17.72)	166 (6.54)	114 (4.49)	170 (6.69)	210 (8.27)	34.5 (1.36)	8 (0.32)	436 (17.17)	20 (0.79)	8 (0.32)	20 (0.79)	6 (0.24)	239 (9.41)	396 (15.59)	M6
2169	264 (10.39)	543 (21.38)	186 (7.32)	149 (5.87)	190 (7.48)	220 (8.66)	29 (1.14)	8 (0.32)	527 (20.75)	19.5 (0.77)	8.5 (0.34)	20.5 (0.81)	7.5 (0.30)	248 (9.76)	487 (19.17)	M8
2211	264 (10.39)	543 (21.38)	186 (7.32)	149 (5.87)	190 (7.48)	220 (8.66)	29 (1.14)	8 (0.32)	527 (20.75)	19.5 (0.77)	8.5 (0.34)	20.5 (0.81)	7.5 (0.30)	248 (9.76)	487 (19.17)	M8
2257	312 (12.28)	700 (27.56)	260 (10.24)	160 (6.30)	218 (8.58)	263 (10.35)	39 (1.54)	8 (0.32)	675 (26.56)	33 (1.30)	12 (0.47)	32 (1.26)	13 (0.51)	296 (11.65)	610 (24.02)	M10
2313	312 (12.28)	700 (27.56)	260 (10.24)	160 (6.30)	218 (8.58)	263 (10.35)	39 (1.54)	8 (0.32)	675 (26.56)	33 (1.30)	12 (0.47)	32 (1.26)	13 (0.51)	296 (11.65)	610 (24.02)	M10
2360	440 (17.32)	800 (31.50)	254 (10.00)	218 (8.58)	370 (14.57)	310 (12.20)	23 (0.91)	12 (0.47)	773 (30.43)	31.5 (1.24)	14 (0.55)	31.5 (1.24)	13 (0.51)	416 (16.38)	710 (27.95)	M12
2415	440 (17.32)	800 (31.50)	254 (10.00)	218 (8.58)	370 (14.57)	310 (12.20)	23 (0.91)	12 (0.47)	773 (30.43)	31.5 (1.24)	14 (0.55)	31.5 (1.24)	13 (0.51)	416 (16.38)	710 (27.95)	M12

*1 The attachment for external heatsink installation is necessary.

Table 2.16 Panel Cut-out Dimensions (Models 4002 to 4389)

Model	Dimensions mm (in)															
	W	H	D1	D2	W1	W2	W3	W4	H1	H2	H3	H4	H5	A	B	d1
4002 *J	140 (5.51)	294 (11.57)	138 (5.43)	38 (1.50)	102 (4.02)	102 (4.02)	16 (0.63)	3 (0.12)	282 (11.10)	23 (0.91)	6 (0.24)	26 (1.02)	6 (0.24)	134 (5.28)	233 (9.17)	M5
4004 *J	140 (5.51)	294 (11.57)	138 (5.43)	38 (1.50)	102 (4.02)	102 (4.02)	16 (0.63)	3 (0.12)	282 (11.10)	23 (0.91)	6 (0.24)	26 (1.02)	6 (0.24)	134 (5.28)	233 (9.17)	M5
4005 *J	140 (5.51)	294 (11.57)	138 (5.43)	38 (1.50)	102 (4.02)	102 (4.02)	16 (0.63)	3 (0.12)	282 (11.10)	23 (0.91)	6 (0.24)	26 (1.02)	6 (0.24)	134 (5.28)	233 (9.17)	M5
4007 *J	140 (5.51)	294 (11.57)	138 (5.43)	73 (2.87)	102 (4.02)	102 (4.02)	16 (0.63)	3 (0.12)	282 (11.10)	23 (0.91)	6 (0.24)	26 (1.02)	6 (0.24)	134 (5.28)	233 (9.17)	M5
4009 *J	140 (5.51)	294 (11.57)	138 (5.43)	73 (2.87)	102 (4.02)	102 (4.02)	16 (0.63)	3 (0.12)	282 (11.10)	23 (0.91)	6 (0.24)	26 (1.02)	6 (0.24)	134 (5.28)	233 (9.17)	M5
4012 *J	140 (5.51)	294 (11.57)	138 (5.43)	73 (2.87)	102 (4.02)	102 (4.02)	16 (0.63)	3 (0.12)	282 (11.10)	23 (0.91)	6 (0.24)	26 (1.02)	6 (0.24)	134 (5.28)	233 (9.17)	M5
4018 *J	140 (5.51)	294 (11.57)	138 (5.43)	73 (2.87)	102 (4.02)	102 (4.02)	16 (0.63)	3 (0.12)	282 (11.10)	23 (0.91)	6 (0.24)	26 (1.02)	6 (0.24)	134 (5.28)	233 (9.17)	M5
4023 *J	140 (5.51)	294 (11.57)	138 (5.43)	73 (2.87)	102 (4.02)	102 (4.02)	16 (0.63)	3 (0.12)	282 (11.10)	23 (0.91)	6 (0.24)	26 (1.02)	6 (0.24)	134 (5.28)	233 (9.17)	M5
4031 *J	180 (7.09)	329 (12.95)	134 (5.28)	68 (2.68)	140 (5.51)	140 (5.51)	17 (0.67)	3 (0.12)	318 (12.52)	23.5 (0.93)	5 (0.20)	24.5 (0.97)	6 (0.24)	174 (6.85)	270 (10.63)	M5
4038 *J	180 (7.09)	329 (12.95)	134 (5.28)	68 (2.68)	140 (5.51)	140 (5.51)	17 (0.67)	3 (0.12)	318 (12.52)	23.5 (0.93)	5 (0.20)	24.5 (0.97)	6 (0.24)	174 (6.85)	270 (10.63)	M5
4044 *J	220 (8.66)	384 (15.12)	140 (5.51)	87 (3.43)	192 (7.56)	192 (7.56)	11 (0.43)	3 (0.12)	371 (14.61)	27 (1.06)	7 (0.28)	25 (0.98)	6 (0.24)	214 (8.43)	319 (12.56)	M6

Model	Dimensions mm (in)															
	W	H	D1	D2	W1	W2	W3	W4	H1	H2	H3	H4	H5	A	B	d1
4060 *1	220 (8.66)	384 (15.12)	140 (5.51)	106 (4.17)	192 (7.56)	192 (7.56)	11 (0.43)	3 (0.12)	371 (14.61)	27 (1.06)	7 (0.28)	25 (0.98)	6 (0.24)	214 (8.43)	319 (12.56)	M6
4075	240 (9.45)	400 (15.75)	166 (6.54)	114 (4.49)	195 (7.68)	204 (8.03)	14.5 (0.57)	8 (0.32)	385 (15.16)	19.5 (0.77)	7.5 (0.30)	19.5 (0.77)	7.5 (0.30)	224 (8.82)	346 (13.62)	M6
4089	255 (10.04)	450 (17.72)	166 (6.54)	114 (4.49)	170 (6.69)	210 (8.27)	34.5 (1.36)	8 (0.32)	436 (17.17)	20 (0.79)	8 (0.32)	20 (0.79)	6 (0.24)	239 (9.41)	396 (15.59)	M6
4103	255 (10.04)	450 (17.72)	166 (6.54)	114 (4.49)	170 (6.69)	210 (8.27)	34.5 (1.36)	8 (0.32)	436 (17.17)	20 (0.79)	8 (0.32)	20 (0.79)	6 (0.24)	239 (9.41)	396 (15.59)	M6
4140	264 (10.39)	543 (21.38)	186 (7.32)	149 (5.87)	190 (7.48)	220 (8.66)	29 (1.14)	8 (0.32)	527 (20.75)	19.5 (0.77)	8.5 (0.34)	20.5 (0.81)	7.5 (0.30)	248 (9.76)	487 (19.17)	M8
4168	264 (10.39)	543 (21.38)	186 (7.32)	149 (5.87)	190 (7.48)	220 (8.66)	29 (1.14)	8 (0.32)	527 (20.75)	19.5 (0.77)	8.5 (0.34)	20.5 (0.81)	7.5 (0.30)	248 (9.76)	487 (19.17)	M8
4208	312 (12.28)	700 (27.56)	260 (10.24)	160 (6.30)	218 (8.58)	263 (10.35)	39 (1.54)	8 (0.32)	675 (26.56)	33 (1.30)	12 (0.47)	32 (1.26)	13 (0.51)	296 (11.65)	610 (24.02)	M10
4250	312 (12.28)	700 (27.56)	260 (10.24)	160 (6.30)	218 (8.58)	263 (10.35)	39 (1.54)	8 (0.32)	675 (26.56)	33 (1.30)	12 (0.47)	32 (1.26)	13 (0.51)	296 (11.65)	610 (24.02)	M10
4296	312 (12.28)	700 (27.56)	260 (10.24)	160 (6.30)	218 (8.58)	263 (10.35)	39 (1.54)	8 (0.32)	675 (26.56)	33 (1.30)	12 (0.47)	32 (1.26)	13 (0.51)	296 (11.65)	610 (24.02)	M10
4371	440 (17.32)	800 (31.50)	254 (10.00)	218 (8.58)	370 (14.57)	310 (12.20)	23 (0.91)	12 (0.47)	773 (30.43)	31.5 (1.24)	14 (0.55)	31.5 (1.24)	13 (0.51)	416 (16.38)	710 (27.95)	M12
4389	440 (17.32)	800 (31.50)	254 (10.00)	218 (8.58)	370 (14.57)	310 (12.20)	23 (0.91)	12 (0.47)	773 (30.43)	31.5 (1.24)	14 (0.55)	31.5 (1.24)	13 (0.51)	416 (16.38)	710 (27.95)	M12

*1 The attachment for external heatsink installation is necessary.

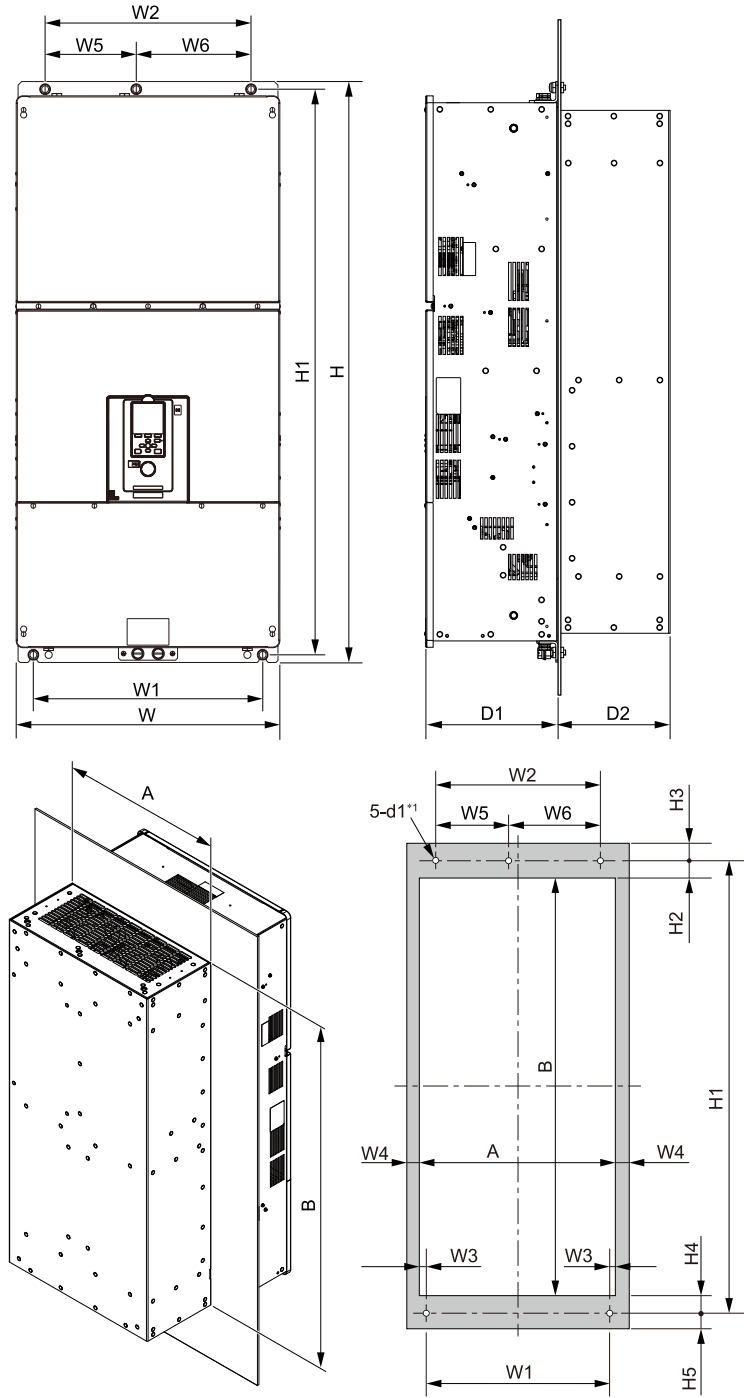

Figure 2.34 Panel Cut-Out Dimensions

*1 Make threads inside the mounting screw holes on the panel.

Table 2.17 Panel Cut-out Dimensions (Models 4453 to 4675)

Model	Dimensions mm (in)																	
	W	H	D1	D2	W1	W2	W3	W4	W5	W6	H1	H2	H3	H4	H5	A	B	d1
4453	510 (20.08)	1136 (44.72)	260 (10.24)	220 (8.66)	450 (17.72)	404 (15.91)	18 (0.71)	12 (0.47)	179 (7.05)	225 (8.86)	1110 (43.70)	34 (1.34)	15 (0.59)	34 (1.34)	15 (0.59)	486 (19.13)	1042 (41.02)	M12
4568	510 (20.08)	1136 (44.72)	260 (10.24)	220 (8.66)	450 (17.72)	404 (15.91)	18 (0.71)	12 (0.47)	179 (7.05)	225 (8.86)	1110 (43.70)	34 (1.34)	15 (0.59)	34 (1.34)	15 (0.59)	486 (19.13)	1042 (41.02)	M12
4675	510 (20.08)	1136 (44.72)	260 (10.24)	220 (8.66)	450 (17.72)	404 (15.91)	18 (0.71)	12 (0.47)	179 (7.05)	225 (8.86)	1110 (43.70)	34 (1.34)	15 (0.59)	34 (1.34)	15 (0.59)	486 (19.13)	1042 (41.02)	M12

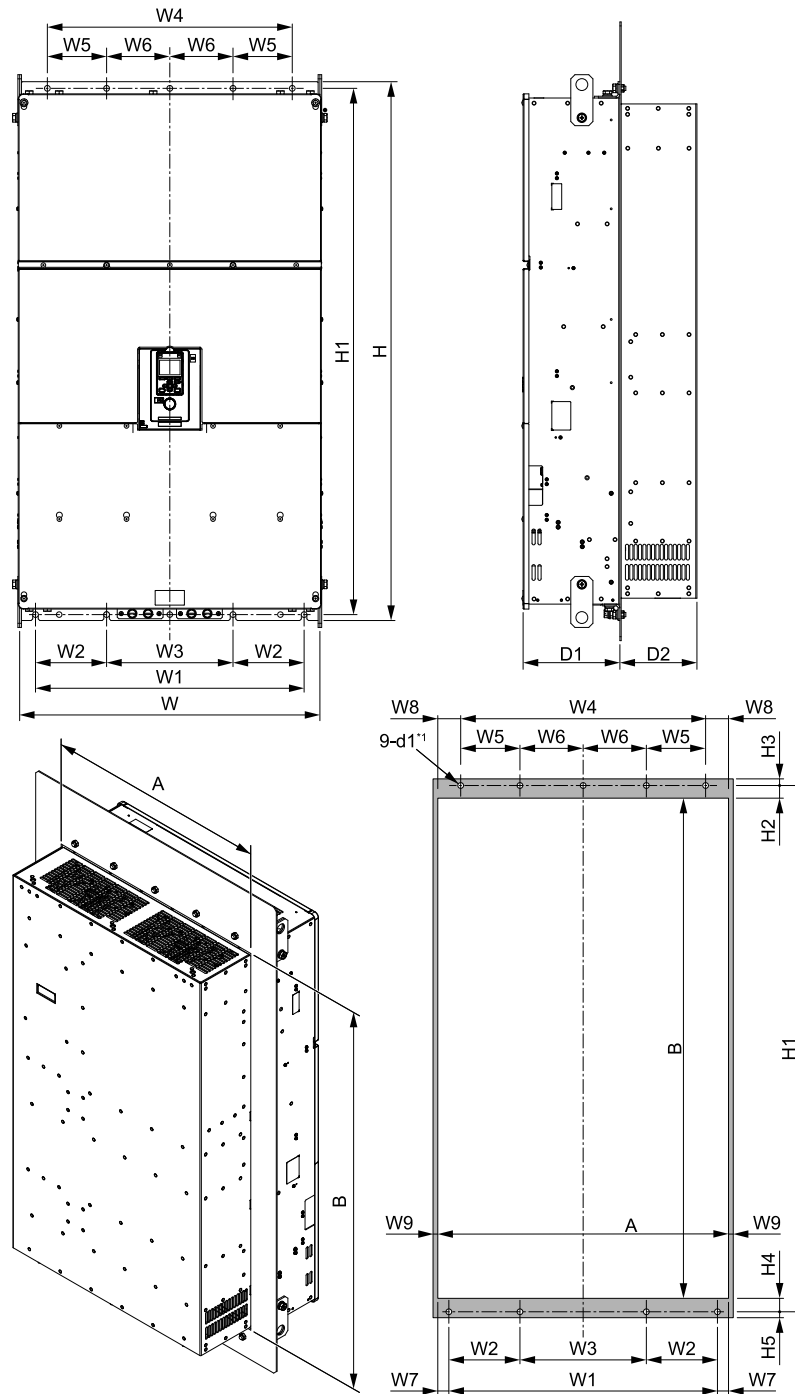

Figure 2.35 Panel Cut-Out Dimensions

*1 Make threads inside the mounting screw holes on the panel.

Table 2.18 Panel Cut-out Dimensions (Models 4810 to 4H12)

Model	Dimensions mm (in)																				
	W	H	D1	D2	W1	W2	W3	W4	W5	W6	W7	W8	W9	H1	H2	H3	H4	H5	A	B	d1
4810	760 (29.9)	1363.8 (53.7)	245 (9.65)	195 (7.67)	680 (26.8)	180 (7.09)	320 (12.6)	620 (24.4)	150 (5.91)	160 (6.3)	28 (1.1)	58 (2.28)	12 (0.47)	1332 (52.4)	32 (1.26)	16.8 (0.66)	34 (1.34)	15 (0.59)	736 (29)	1266 (49.8)	M12
4930	760 (29.9)	1363.8 (53.7)	245 (9.65)	195 (7.67)	680 (26.8)	180 (7.09)	320 (12.6)	620 (24.4)	150 (5.91)	160 (6.3)	28 (1.1)	58 (2.28)	12 (0.47)	1332 (52.4)	32 (1.26)	16.8 (0.66)	34 (1.34)	15 (0.59)	736 (29)	1266 (49.8)	M12
4H11	760 (29.9)	1363.8 (53.7)	245 (9.65)	195 (7.67)	680 (26.8)	180 (7.09)	320 (12.6)	620 (24.4)	150 (5.91)	160 (6.3)	28 (1.1)	58 (2.28)	12 (0.47)	1332 (52.4)	32 (1.26)	16.8 (0.66)	34 (1.34)	15 (0.59)	736 (29)	1266 (49.8)	M12
4H12	760 (29.9)	1363.8 (53.7)	245 (9.65)	195 (7.67)	680 (26.8)	180 (7.09)	320 (12.6)	620 (24.4)	150 (5.91)	160 (6.3)	28 (1.1)	58 (2.28)	12 (0.47)	1332 (52.4)	32 (1.26)	16.8 (0.66)	34 (1.34)	15 (0.59)	736 (29)	1266 (49.8)	M12

Electrical Installation

This chapter gives how to wire the control circuit terminals, motor, and power supply of the drive.

3.1	Section Safety	64
3.2	Electrical Installation	66
3.3	Main Circuit Wiring	71
3.4	Main Circuit Terminal Block Wiring Procedure	96
3.5	Control Circuit Wiring	104
3.6	Control I/O Connections	115
3.7	Connect the Drive to a PC	119
3.8	External Interlock	120
3.9	Braking Resistor Installation	121
3.10	Drive Wiring Protection	130
3.11	Dynamic Braking Option, Motor Protection	131
3.12	Improve the Power Factor	133
3.13	Prevent Switching Surge	134
3.14	Decrease Noise	135
3.15	Protect the Drive during Failures	137
3.16	Wiring Checklist	141
3.17	Motor Application Precautions	143

3.1 Section Safety

DANGER

Electrical Shock Hazard

Do not examine, connect, or disconnect wiring on an energized drive. Before servicing, disconnect all power to the equipment and wait for the time specified on the warning label at a minimum. The internal capacitor stays charged after the drive is de-energized. The charge indicator LED extinguishes when the DC bus voltage decreases below 50 Vdc. When all indicators are OFF, remove the covers before measuring for dangerous voltages to make sure that the drive is safe.

If you do work on the drive when it is energized, it will cause serious injury or death from electrical shock.

WARNING

Electrical Shock Hazard

Do not operate the drive when covers are missing. Replace covers and shields before you operate the drive. Use the drive only as specified by the instructions.

Some figures in this section include drives without covers or safety shields to more clearly show the inside of the drive. If covers or safety shields are missing from the drive, it can cause serious injury or death.

Ground the neutral point on the power supply of drive models 2xxxB/C and 4xxxB/C to comply with the EMC Directive before you turn on the EMC filter.

If you turn ON the EMC filter, but you do not ground the neutral point, it can cause serious injury or death.

Crush Hazard

Make sure that the protective ground wire complies with technical standards and local safety regulations. The IEC/EN 61800-5-1 standard specifies that you must wire the power supply to automatically de-energize when the protective ground wire disconnects. You can also connect a protective ground wire that has a minimum cross-sectional area of 10 mm² (copper wire) or 16 mm² (aluminum wire). The leakage current of the drive will be more than 3.5 mA in drive models;

- 2xxxB
- 2xxxC
- 4002B to 4371B
- 4002C to 4371C (with built-in EMC filter turned ON)
- 4389 to 4H12

If you do not obey the standards and regulations, it can cause serious injury or death.

Electrical Shock Hazard

When there is a DC component in the protective earthing conductor, the drive can cause a residual current. When a residual current operated protective or monitoring device prevents direct or indirect contact, always use a type B Residual Current Monitor/Residual Current Device (RCM/RCD) as specified by IEC/EN 60755.

If you do not use the correct RCM/RCD, it can cause serious injury or death.

Do not wear loose clothing or jewelry when you do work on the drive. Tighten loose clothing and remove all metal objects, for example watches or rings.

Loose clothing can catch on the drive and jewelry can conduct electricity and cause serious injury or death.

Do not remove covers or touch circuit boards while the drive is energized.

If you touch the internal components of an energized drive, it can cause serious injury or death.

Only let approved personnel install, wire, maintain, examine, replace parts, and repair the drive.

If personnel are not approved, it can cause serious injury or death.

Do not modify the drive body or drive circuitry.

Modifications to drive body and circuitry can cause serious injury or death, will cause damage to the drive, and will void the warranty. Yaskawa is not responsible for modifications of the product made by the user.

Fire Hazard

Tighten all terminal screws to the correct tightening torque.

Connections that are too loose or too tight can cause incorrect operation and damage to the drive. Incorrect connections can also cause death or serious injury from fire.

⚠ WARNING

Tighten screws at an angle in the specified range shown in this manual.

If you tighten the screws at an angle not in the specified range, you can have loose connections that can cause damage to the terminal block or start a fire and cause serious injury or death.

Damage to Equipment

Do not apply incorrect voltage to the main circuit of the drive. Operate the drive in the specified range of the input voltage on the drive nameplate.

Voltages that are higher than the permitted nameplate tolerance can cause damage to the drive.

Fire Hazard

When you install a dynamic braking option, wire the components as specified by the wiring diagrams.

Incorrect wiring can cause damage to braking components or serious injury or death.

NOTICE

Do not let unwanted objects, for example metal shavings or wire clippings, fall into the drive during drive installation. Put a temporary cover over the drive during installation. Remove the temporary cover before start-up.

Unwanted objects inside of the drive can cause damage to the drive.

Damage to Equipment

When you touch the drive and circuit boards, make sure that you observe correct electrostatic discharge (ESD) procedures.

If you do not follow procedures, it can cause ESD damage to the drive circuitry.

Select a motor that is compatible with the load torque and speed range. When 100% continuous torque is necessary at low speed, use an inverter-duty motor or vector-duty motor. When you use a standard fan-cooled motor, decrease the motor torque in the low-speed range.

If you operate a standard fan-cooled motor at low speed and high torque, it will decrease the cooling effects and can cause heat damage.

Obey the speed range specification of the motor as specified by the manufacturer. When you must operate the motor outside of its specifications, contact the motor manufacturer.

If you continuously operate oil-lubricated motors outside of the manufacturer specifications, it can cause damage to the motor bearings.

When the input voltage is 440 V or higher or the wiring distance is longer than 100 m (328 ft), make sure that the motor insulation voltage is sufficient or use an inverter-duty motor or vector-duty motor with reinforced insulation.

Motor winding and insulation failure can occur.

Before you connect a dynamic braking option to the drive, make sure that qualified personnel read and obey the Braking Unit and Braking Resistor Unit Installation Manual (TOBPC72060001).

If you do not read and obey the manual or if personnel are not qualified, it can cause damage to the drive and braking circuit.

Make sure that all connections are correct after you install the drive and connect peripheral devices.

Incorrect connections can cause damage to the drive.

Note:

- Torque characteristics are different than when you operate the motor directly from line power. Make sure that you understand the load torque characteristics for the application.
- The current rating of submersible motors is usually higher than the current rating of standard motors for a given motor power. Make sure that the rated output current of the drive is equal to or more than the current rating of the motor. If the motor wire length is longer than 100 m (328 ft), select the correct wire gauge to adjust for a loss in voltage and prevent loss of motor torque.
- Do not use unshielded wire for control wiring. Use shielded, twisted-pair wires and ground the shield to the ground terminal of the drive. Unshielded wire can cause electrical interference and unsatisfactory system performance.

3.2 Electrical Installation

DANGER! *Electrical Shock Hazard. Do not examine, connect, or disconnect wiring on an energized drive. Before servicing, disconnect all power to the equipment and wait for the time specified on the warning label at a minimum. The internal capacitor stays charged after the drive is de-energized. The charge indicator LED extinguishes when the DC bus voltage decreases below 50 Vdc. When all indicators are OFF, remove the covers before measuring for dangerous voltages to make sure that the drive is safe. If you do work on the drive when it is energized, it will cause serious injury or death from electrical shock.*

WARNING! *Electrical Shock Hazard. De-energize the drive and wait 5 minutes minimum until the Charge LED turns off. Remove the front cover and terminal cover to do work on wiring, circuit boards, and other parts. Use terminals for their correct function only. Incorrect wiring, incorrect ground connections, and incorrect repair of protective covers can cause death or serious injury.*

WARNING! *Electrical Shock Hazard. Correctly ground the drive before you turn on the EMC filter switch. If you touch electrical equipment that is not grounded, it can cause serious injury or death.*

WARNING! *Electrical Shock Hazard. Use the terminals for the drive only for their intended purpose. Refer to the technical manual for more information about the I/O terminals. Wiring and grounding incorrectly or modifying the cover may damage the equipment or cause injury.*

◆ Standard Connection Diagram

Wire the drive as specified by [Standard Drive Connection Diagram on page 67](#).

WARNING! *Sudden Movement Hazard. Set the MFDI parameters before you close control circuit switches. Incorrect Run/Stop circuit sequence settings can cause serious injury or death from moving equipment.*

WARNING! *Sudden Movement Hazard. Correctly wire the start/stop and safety circuits before you energize the drive. If you momentarily close a digital input terminal, it can start a drive that is programmed for 3-Wire control and cause serious injury or death from moving equipment.*

WARNING! *Sudden Movement Hazard. When you use a 3-Wire sequence, set A1-03 = 3330 [Initialize Parameters = 3-Wire Initialization] and make sure that b1-17 = 0 [Run Command at Power Up = Disregard Existing RUN Command] (default). If you do not correctly set the drive parameters for 3-Wire operation before you energize the drive, the motor can suddenly rotate when you energize the drive.*

WARNING! *Sudden Movement Hazard. Check the I/O signals and the external sequences for the drive before you set the Application Preset function. When you set the Application Preset function (A1-06 ≠ 0), it changes the I/O terminal functions for the drive and it can cause equipment to operate unusually. This can cause serious injury or death.*

WARNING! *Fire Hazard. Install sufficient branch circuit short circuit protection as specified by applicable codes and this manual. The drive is suitable for circuits that supply not more than 100,000 RMS symmetrical amperes, 240 Vac maximum (200 V Class), 480 Vac maximum (400 V Class). Incorrect branch circuit short circuit protection can cause serious injury or death.*

NOTICE: *When the input voltage is 440 V or higher or the wiring distance is longer than 100 m (328 ft), make sure that the motor insulation voltage is sufficient or use an inverter-duty motor or vector-duty motor with reinforced insulation. Motor winding and insulation failure can occur.*

Note:

Do not connect the AC control circuit ground to the drive enclosure. Failure to obey can cause incorrect control circuit operation.

Standard Drive Connection Diagram

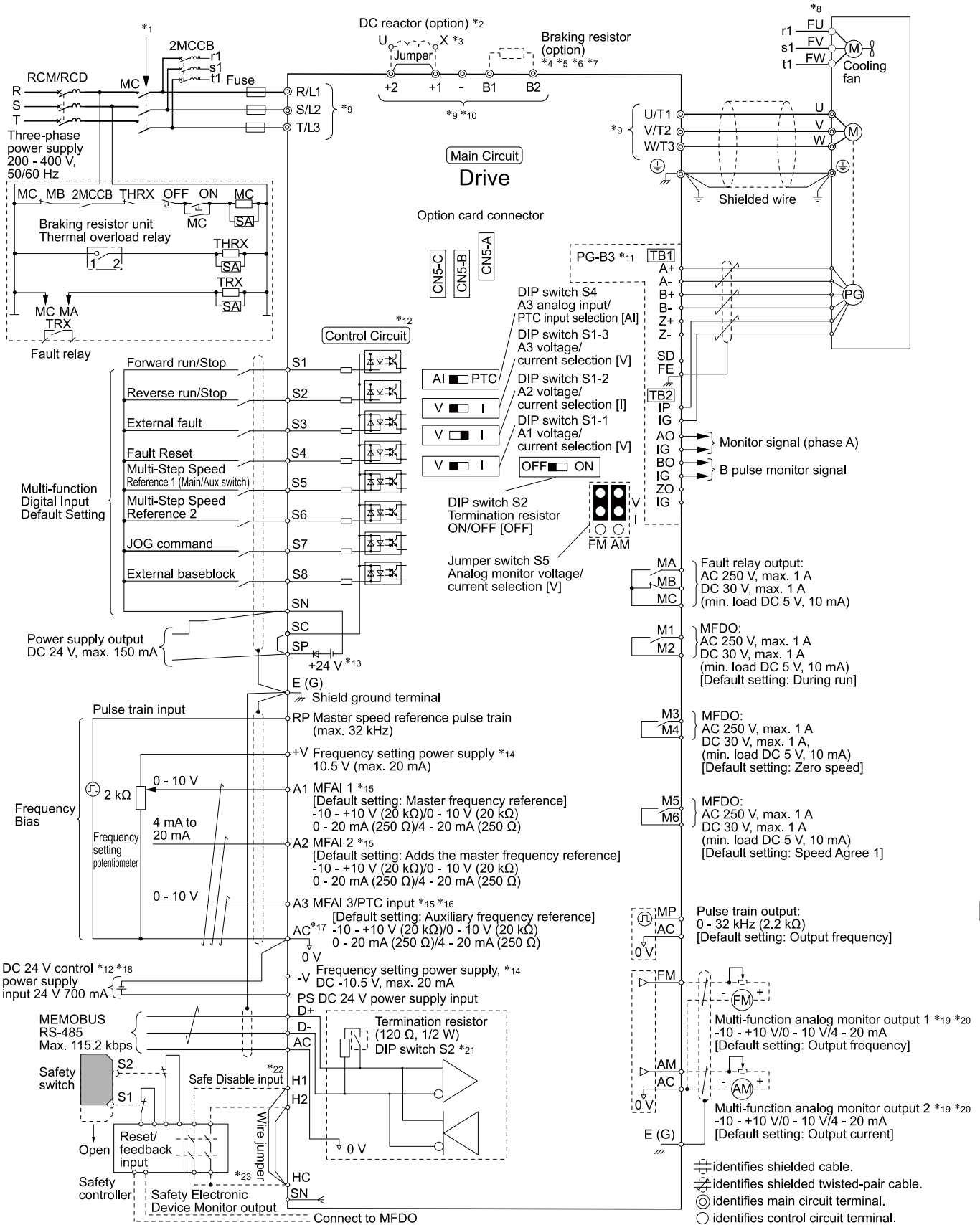

Figure 3.1 Standard Drive Connection Diagram

- *1 Set the wiring sequence to de-energize the drive with the fault relay output. If the drive outputs a fault during fault restart when you use the fault restart function, set L5-02 = 1 [Fault Contact at Restart Select = Always Active] to de-energize the drive. Be careful when you use a cut-off sequence. The default setting for L5-02 is 0 [Active Only when Not Restarting].
- *2 When you install a DC reactor, you must remove the jumper between terminals +1 and +2. Ground the DC reactor (option) on the back of the mounting base. Remove all paint from the mounting surface of the control panel.

3.2 Electrical Installation

- *3 Models 2110 to 2415 and 4060 to 4H12 have a DC reactor.
- *4 When you use a regenerative converter, regenerative unit, or braking unit, set $L8-55 = 0$ [Internal DB TransistorProtection = Disable]. If $L8-55 = 1$ [Protection Enabled], the drive will detect rF [Braking Resistor Fault].
- *5 When you use a regenerative converter, regenerative unit, braking unit, braking resistor, or braking resistor unit, set $L3-04 = 0$ [Stall Prevention during Decel = Disabled]. If $L3-04 = 1$ [General Purpose], the drive could possibly not stop in the specified deceleration time.
- *6 When you use an ERF-type braking resistor, set $L8-01 = 1$ [3% ERF DB Resistor Protection = Enabled] and set a wiring sequence to de-energize the drive with the fault relay output.
- *7 When you connect a braking unit (CDBR series) or a braking resistor unit (LKEB series) to drive models 2110, 2138, and 4103, make sure that you use wires that are in the range of the applicable gauges for the drive. A junction terminal is necessary to connect wires that are less than the applicable gauge to the drive. Contact Yaskawa or your nearest sales representative for more information about selection and installation of the junction terminal.
- *8 Cooling fan wiring is not necessary for self-cooling motors.
- *9 The number of terminals is different for different models.
 - Terminals R/L1, S/L2, T/L3, U/T1, V/T2, W/T3: There are two screws for each terminal block on models 4453 to 4675. There are four screws for each terminal block on models 4810 to 4H12.
 - Terminal +3: Models 2169 to 2415 and 4208 to 4H12 only. There are two screws for each terminal block on models 4453 to 4675. There are four screws for each terminal block on models 4810 to 4H12.
 - Terminal +2: Models 2004 to 2082 and 4002 to 4044 only.
 - Terminals +1, -: There are two screws for each terminal block on models 2169, 2211, 4140, 4168, and 4453 to 4675. There are four screws for each terminal block on models 4810 to 4H12.
 - Terminal B1: Models 2004 to 2138 and 4002 to 4168 only.
- *10 Connect peripheral options to terminals -, +1, +2, B1, and B2.

WARNING! Fire Hazard. Only connect factory-recommended devices or circuits to drive terminals B1, B2, -, +1, +2, and +3. Do not connect an AC power supply lines to these terminals. Incorrect wiring can cause damage to the drive and serious injury or death from fire.
- *11 Encoder circuit wiring (wiring to PG-B3 option) is not necessary for applications that do not use motor speed feedback.
- *12 Connect a 24 V power supply to terminals PS-AC to operate the control circuit while the main circuit power supply is OFF.
- *13 To set the MFDI power supply (Sinking/Sourcing Mode or internal/external power supply), install or remove a jumper between terminals SC-SP or SC-SN depending on the application.

NOTICE: Damage to Equipment. Do not close the circuit between terminals SP-SN. If you close the circuits between terminals SC-SP and terminals SC-SN at the same time, it will cause damage to the drive.

 - Sinking Mode, Internal power supply: Install the jumper to close the circuit between terminals SC-SP.

NOTICE: Damage to Equipment. Do not close the circuit between terminals SC-SN. If you close the circuits between terminals SC-SP and terminals SC-SN at the same time, it will cause damage to the drive.
 - Sourcing Mode, Internal power supply: Install the jumper to close the circuit between terminals SC-SN.

NOTICE: Damage to Equipment. Do not close the circuit between terminals SC-SP. If you close the circuits between terminals SC-SP and terminals SC-SN at the same time, it will cause damage to the drive.
 - External power supply: Remove the jumper from the MFDI terminals. It is not necessary to close the circuit between terminals SC-SP and terminals SC-SN.
- *14 The maximum output current capacity for terminals +V and -V on the control circuit is 20 mA.

NOTICE: Do not install a jumper between terminals +V, -V, and AC. A closed circuit between these terminals will cause damage to the drive.
- *15 DIP switches S1-1 to S1-3 set terminals A1 to A3 for voltage or current input. The default setting for S1-1 and S1-3 is voltage input ("V" side). The default setting for S1-2 is current input ("I" side).
- *16 DIP switch S4 sets terminal A3 for analog or PTC input. Set DIP switch S1-3 to the "V" side, and set $H3-05 = 0$ [Terminal A3 Signal Level Select = 0 to 10V (Lower Limit at 0)] to set terminal A3 for PTC input with DIP switch S4.
- *17 Do not ground control circuit terminal AC or connect it to the drive chassis.

NOTICE: Do not ground the AC control circuit terminals and only connect the AC terminals according to the product instructions. If you connect the AC terminals incorrectly, it can cause damage to the drive.
- *18 Connect the positive lead from an external 24 Vdc power supply to terminal PS and the negative lead to terminal AC.

NOTICE: Connect terminals PS and AC correctly for the 24 V power supply. If you connect the wires to the incorrect terminals, it will cause damage to the drive.
- *19 Use multi-function analog monitor outputs with analog frequency meters, ammeters, voltmeters, and wattmeters. Do not use monitor outputs with feedback-type signal devices.
- *20 Jumper switch S5 sets terminals FM and AM for voltage or current output. The default setting for S5 is voltage output ("V" side).
- *21 Set DIP switch S2 to "ON" to enable the termination resistor in the last drive in a MEMOBUS/Modbus network.
- *22 Use only Sourcing Mode for Safe Disable input.
- *23 Disconnect the wire jumpers between H1 and HC and H2 and HC to use the Safe Disable input.

Standard Connection Diagram for 6-Phase/12-Pulse Drives

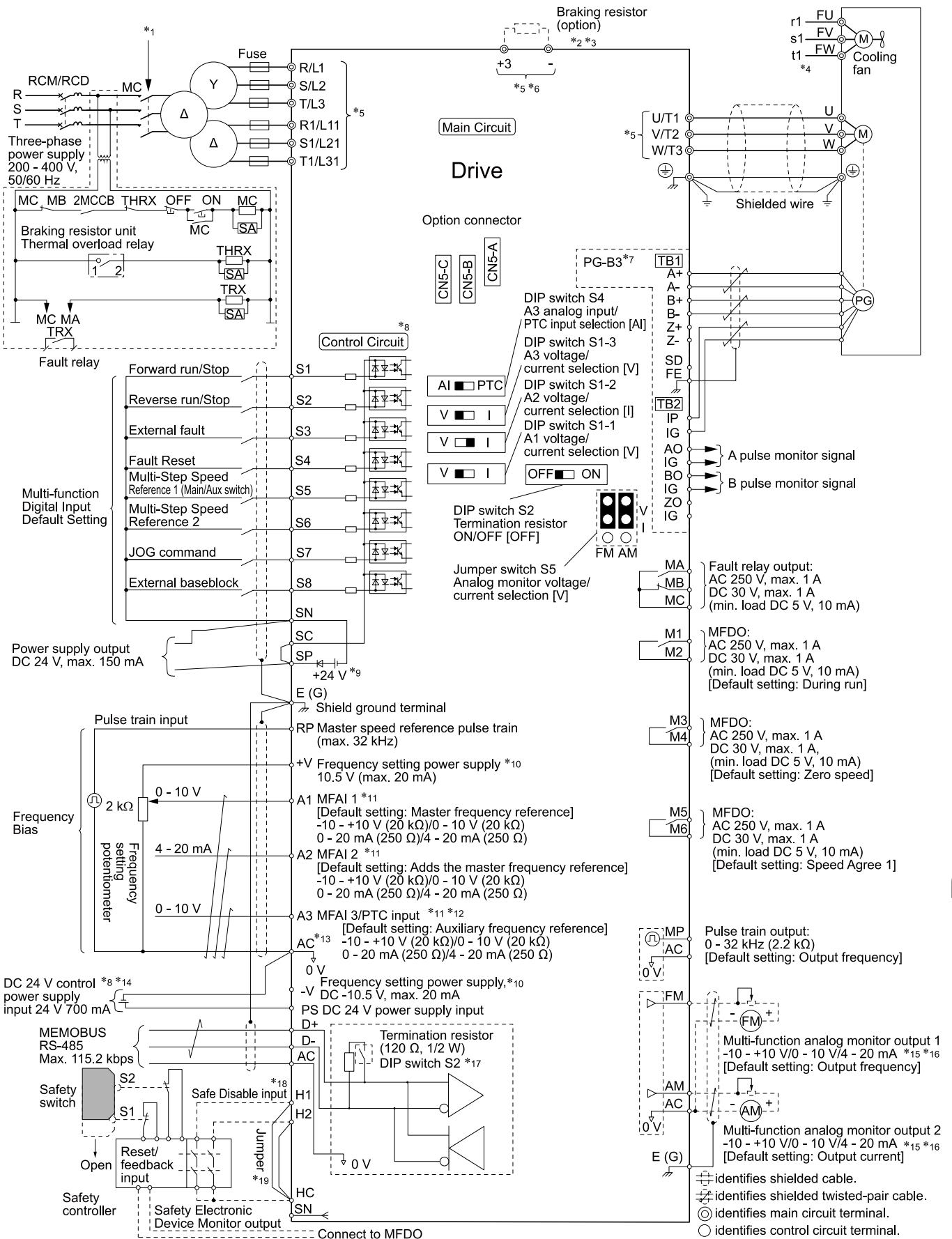

Figure 3.2 Standard Drive Connection Diagram: 6-Phase/12-Pulse Drives

3.2 Electrical Installation

- *1 Set the wiring sequence so the fault relay output de-energizes the drive. If the drive outputs a fault during fault restart when you use the fault restart function, set $L5-02 = 1$ [*Fault Contact at Restart Select = Always Active*] to de-energize the drive. Be careful when you use a cut-off sequence. The default setting for $L5-02$ is 0 [*Active Only when Not Restarting*].
- *2 When you use a braking unit, set $L8-55 = 0$ [*Internal DB Transistor Protection = Disable*]. If $L8-55 = 1$ [*Protection Enabled*], the drive will detect rF [*Braking Resistor Fault*].
- *3 When you use a braking unit, set $L3-04 = 0$ [*Stall Prevention during Decel = Disabled*]. If $L3-04 = 1$ [*General Purpose*], the drive could possibly not stop in the specified deceleration time.
- *4 Cooling fan wiring is not necessary for self-cooling motors.
- *5 The number of terminals is different for different models.
- Terminals U/T1, V/T2, W/T3: There are two terminals for each phase on the terminal block and there are two screws on each terminal (four screws total for each phase) on models 4810 to 4H12.
 - Terminals +3, -: There are four screws for each terminal block on models 4810 to 4H12.
- *6 Use terminals - and +3 to connect options to the drive.
- WARNING! Fire Hazard.** Only connect factory-recommended devices or circuits to drive terminals - and +3. Do not connect AC power supply lines to these terminals. Incorrect wiring can cause damage to the drive and serious injury or death from fire.
- *7 Encoder circuit wiring (wiring to PG-B3 option) is not necessary for applications that do not use motor speed feedback.
- *8 Connect a 24 V power supply to terminals PS-AC to operate the control circuit while the main circuit power supply is OFF.
- *9 To set the MFDI power supply (Sinking/Sourcing Mode or internal/external power supply), install or remove a jumper between terminals SC-SP or SC-SN depending on the application.
- NOTICE: Damage to Equipment.** Do not close the circuit between terminals SP-SN. If you close the circuits between terminals SC-SP and terminals SC-SN at the same time, it will cause damage to the drive.
- Sinking Mode, Internal power supply: Install the jumper to close the circuit between terminals SC-SP.
NOTICE: Damage to Equipment. Do not close the circuit between terminals SC-SN. If you close the circuits between terminals SC-SP and terminals SC-SN at the same time, it will cause damage to the drive.
 - Sourcing Mode, Internal power supply: Install the jumper to close the circuit between terminals SC-SN.
NOTICE: Damage to Equipment. Do not close the circuit between terminals SC-SP. If you close the circuits between terminals SC-SP and terminals SC-SN at the same time, it will cause damage to the drive.
 - External power supply: Remove the jumper from the MFDI terminals. It is not necessary to close the circuit between terminals SC-SP and terminals SC-SN.
- *10 The maximum output current capacity for terminals +V and -V on the control circuit is 20 mA.
- NOTICE: Do not install a jumper between terminals +V, -V, and AC. A closed circuit between these terminals will cause damage to the drive.**
- *11 DIP switches S1-1 to S1-3 set terminals A1 to A3 for voltage or current input. The default setting for S1-1 and S1-3 is voltage input ("V" side). The default setting for S1-2 is current input ("I" side).
- *12 DIP switch S4 sets terminal A3 for analog or PTC input. Set DIP switch S1-3 to the "V" side, and set $H3-05 = 0$ [*Terminal A3 Signal Level Select = 0 to 10V (Lower Limit at 0)*] to set terminal A3 for PTC input with DIP switch S4.
- *13 Do not ground control circuit terminal AC or connect it to the drive chassis.
- NOTICE: Do not ground the AC control circuit terminals and only connect the AC terminals according to the product instructions. If you connect the AC terminals incorrectly, it can cause damage to the drive.**
- *14 Connect the positive lead from an external 24 Vdc power supply to terminal PS and the negative lead to terminal AC.
- NOTICE: Connect terminals PS and AC correctly for the 24 V power supply. If you connect the wires to the incorrect terminals, it will cause damage to the drive.**
- *15 Use multi-function analog monitor outputs with analog frequency meters, ammeters, voltmeters, and wattmeters. Do not use monitor outputs with feedback-type signal devices.
- *16 Jumper switch S5 sets terminals FM and AM for voltage or current output. The default setting for S5 is voltage output ("V" side).
- *17 Set DIP switch S2 to "ON" to enable the termination resistor in the last drive in a MEMOBUS/Modbus network.
- *18 Use only Sourcing Mode for Safe Disable input.
- *19 Disconnect the wire jumpers between H1 and HC and H2 and HC to use the Safe Disable input.

3.3 Main Circuit Wiring

This section gives information about the functions, specifications, and procedures necessary to safely and correctly wire the main circuit in the drive.

NOTICE: Damage to Equipment. Do not energize and de-energize the drive more frequently than one time each 30 minutes. If you frequently energize and de-energize the drive, it can cause drive failure.

Note:

Soldered wire connections can become loose over time and cause unsatisfactory drive performance.

◆ Motor and Main Circuit Connections

WARNING! Electrical Shock Hazard. Do not connect terminals R/L1, S/L2, T/L3, U/T1, V/T2, W/T3, -, +1, +2, +3, B1, or B2 to the ground terminal. If you connect these terminals to earth ground, it can cause damage to the drive or serious injury or death.

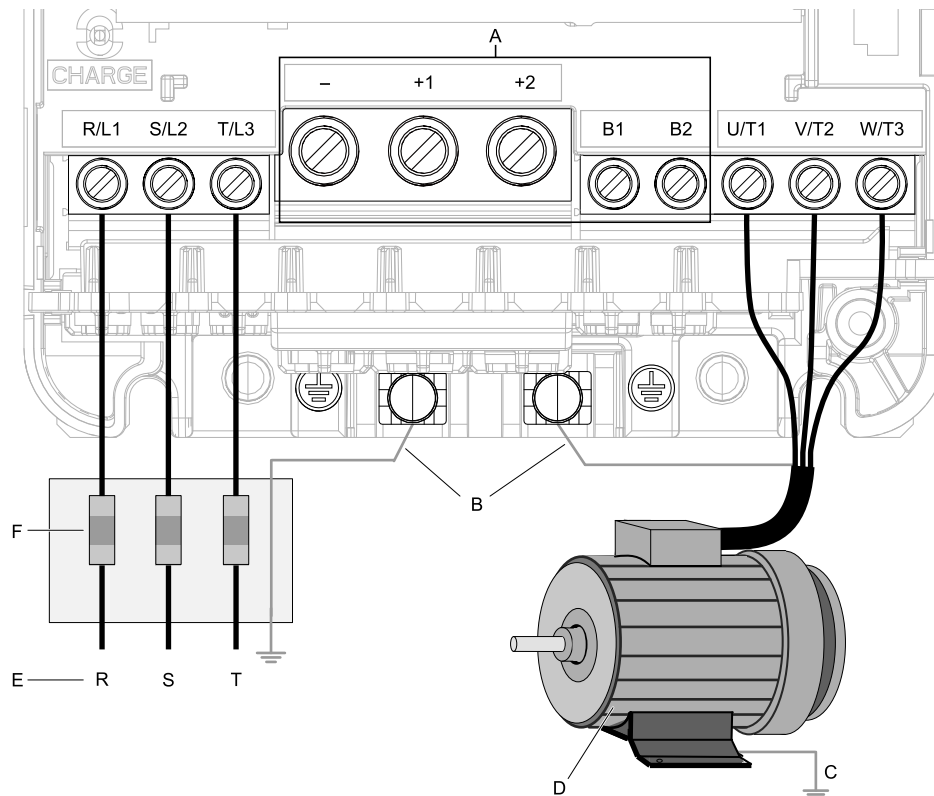

Note:

The location of terminals are different for different drive models.

- | | |
|--|---|
| A - DC bus terminal | D - Three-Phase Motor |
| B - Connect to the drive ground terminal. | E - Use R, S, T for input power supply. |
| C - Ground the motor case. | F - Input Protection (Fuses or Circuit Breakers) |

Figure 3.3 Main Circuit Terminal and Motor Wiring

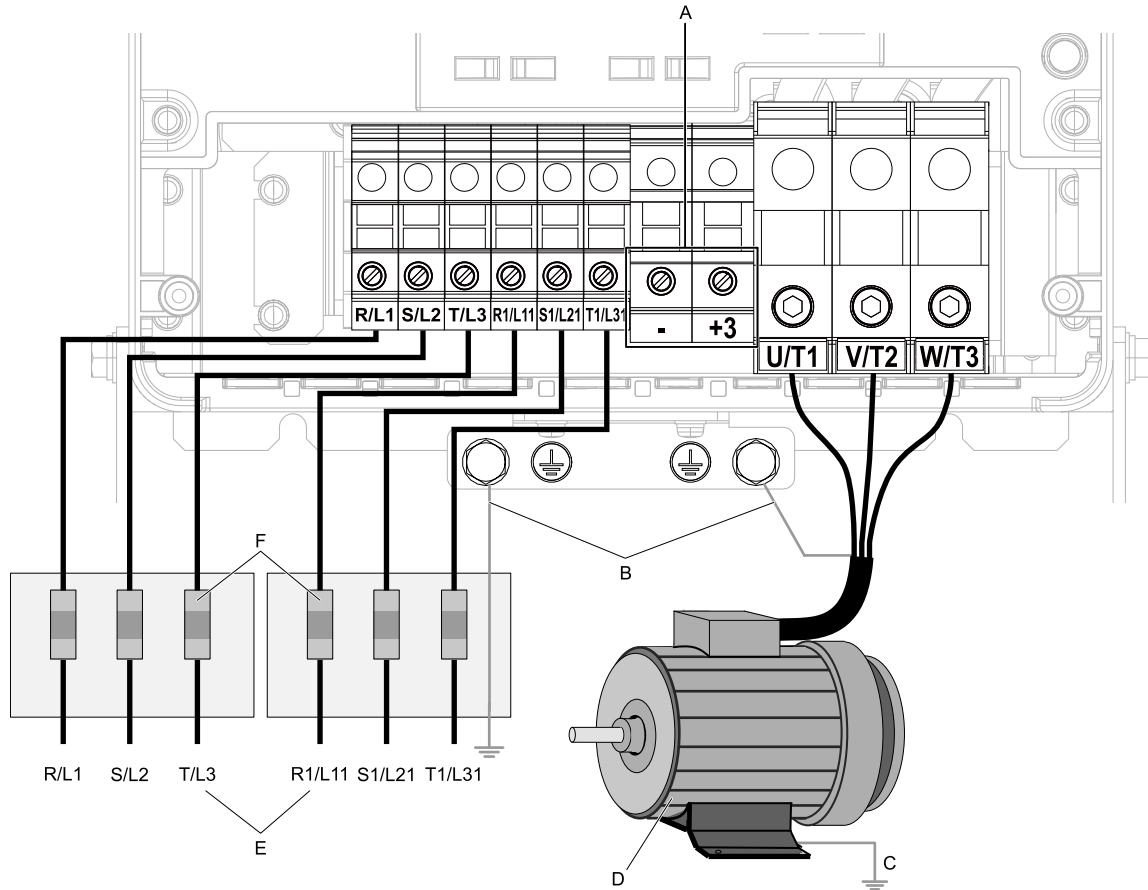

Note:

The location of terminals are different for different drive models.

- A - DC bus terminal**
- B - Connect to the drive ground terminal.**
- C - Ground the motor case.**
- D - Three-Phase Motor**
- E - Use terminals R/L1, S/L2, T/L3, R1/L11, S1/L21, and T1/L31.**
- F - Input Protection (Fuses or Circuit Breakers)**

Figure 3.4 Main Circuit Terminal Functions: 6-Phase/12-Pulse Drives

◆ **Configuration of Main Circuit Terminal Block**

Use [Table 3.1](#) to find the correct main circuit terminal block figure for your drive.

Table 3.1 Configuration of Main Circuit Terminal Block

Model	Shape of Terminal ^{*/1}	Figure
2004 - 2042, 4002 - 4023	European terminal	Figure 3.5
2056, 4031, 4038	European terminal	Figure 3.6
2070, 2082	European terminal	Figure 3.7
4044	European terminal	Figure 3.8
4060	European terminal	Figure 3.9
2110	European terminal	Figure 3.10
4075	European terminal	Figure 3.11
4089	European terminal	Figure 3.12
2138, 4103	European terminal	Figure 3.13
2169, 2211, 4140, 4168	European terminal	Figure 3.14
2257, 2313, 4208 to 4296	Screw terminal	Figure 3.15
2360, 2415, 4371, 4389	Screw terminal	Figure 3.16
4453 - 4675	Screw terminal	Figure 3.17
4810 - 4H12	Screw terminal	Figure 3.18

*1 The ground terminal is a screw terminal.

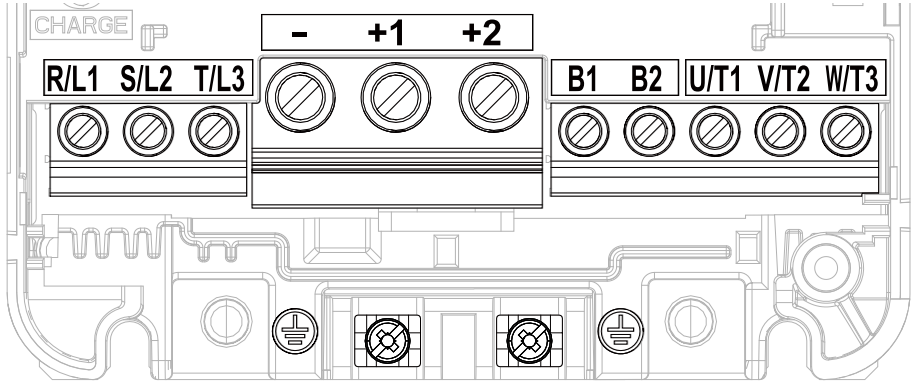

Figure 3.5 Configuration of Main Circuit Terminal Block (2004 - 2042, 4002 - 4023)

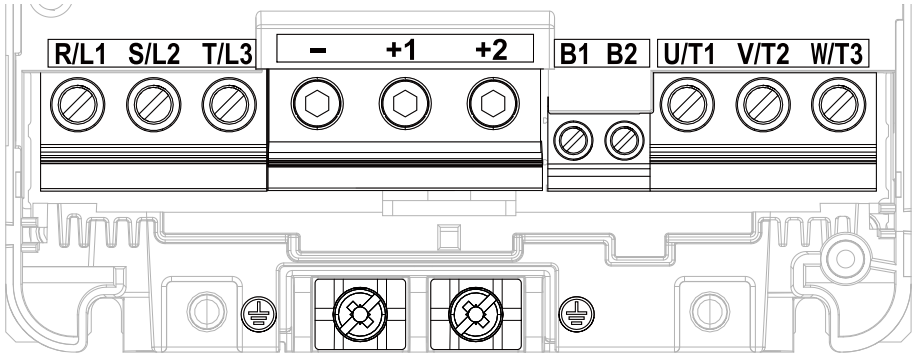

Figure 3.6 Configuration of Main Circuit Terminal Block (2056, 4031, 4038)

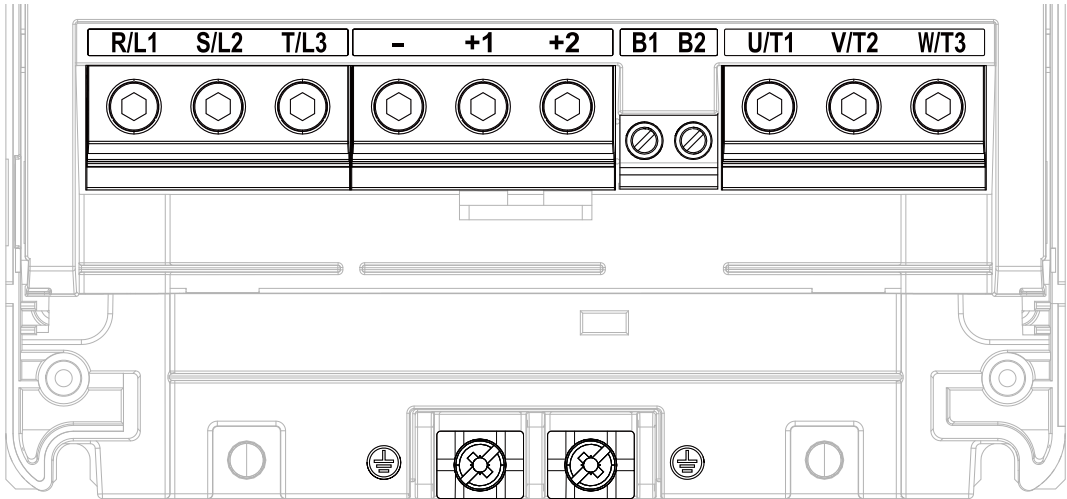

Figure 3.7 Configuration of Main Circuit Terminal Block (2070, 2082)

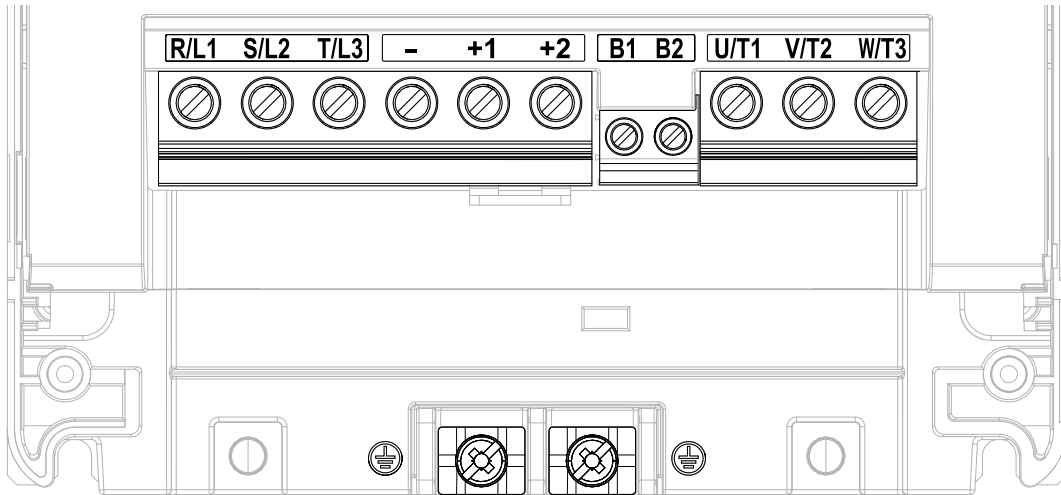

Figure 3.8 Configuration of Main Circuit Terminal Block (4044)

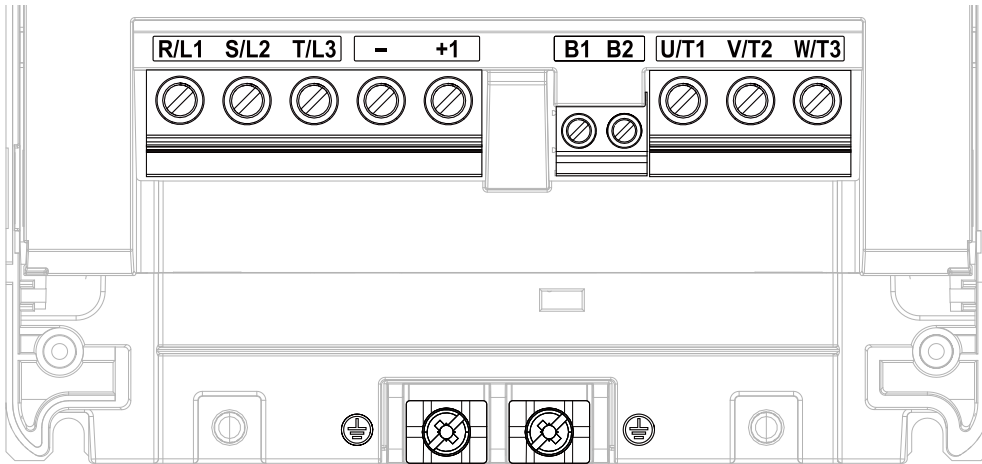

Figure 3.9 Configuration of Main Circuit Terminal Block (4060)

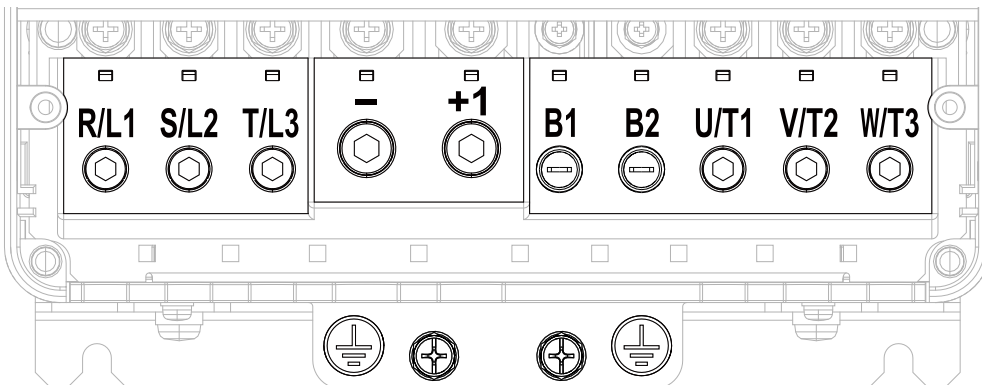

Figure 3.10 Configuration of Main Circuit Terminal Block (2110)

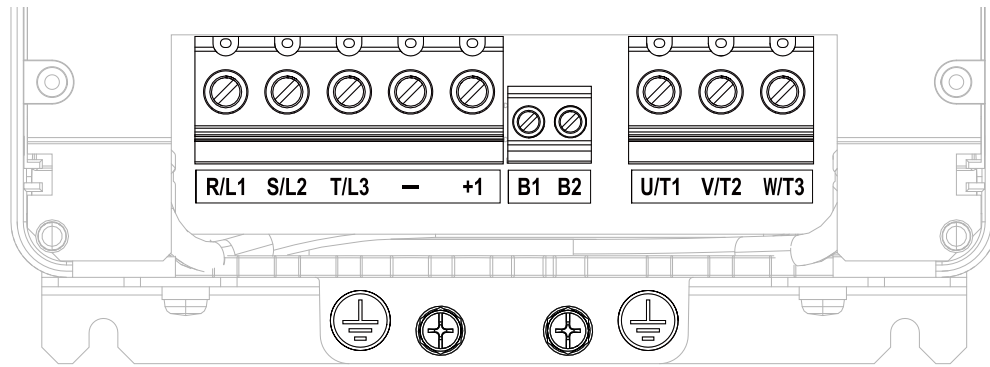

Figure 3.11 Configuration of Main Circuit Terminal Block (4075)

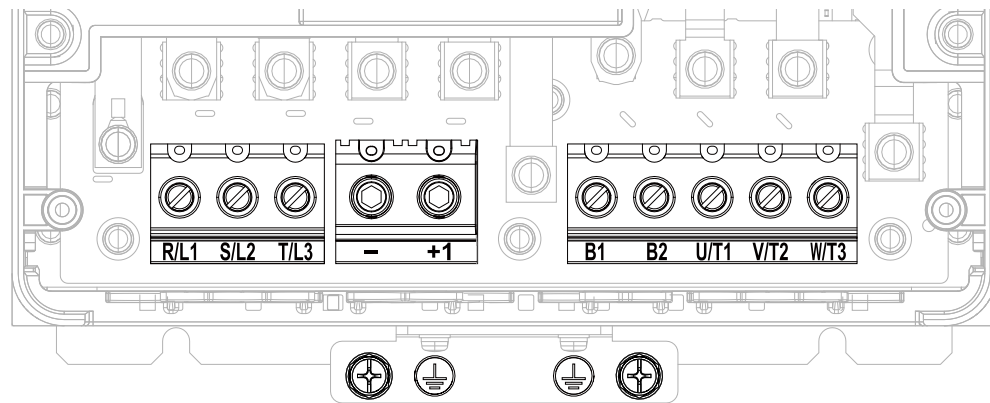

Figure 3.12 Configuration of Main Circuit Terminal Block (4089)

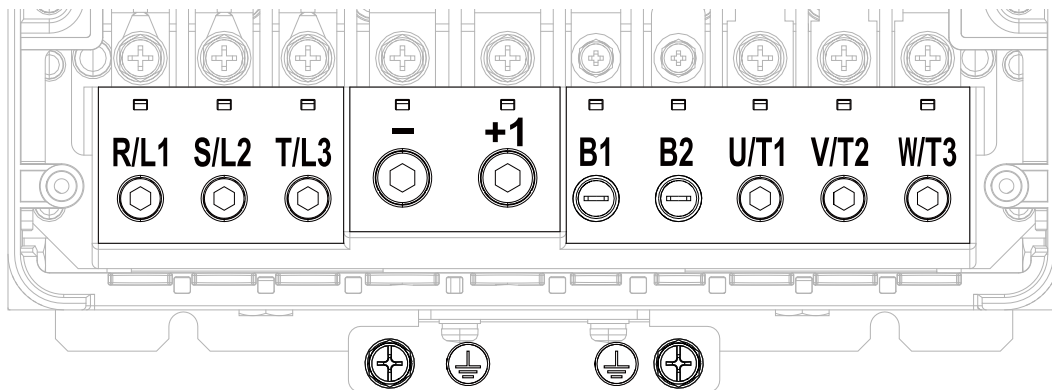
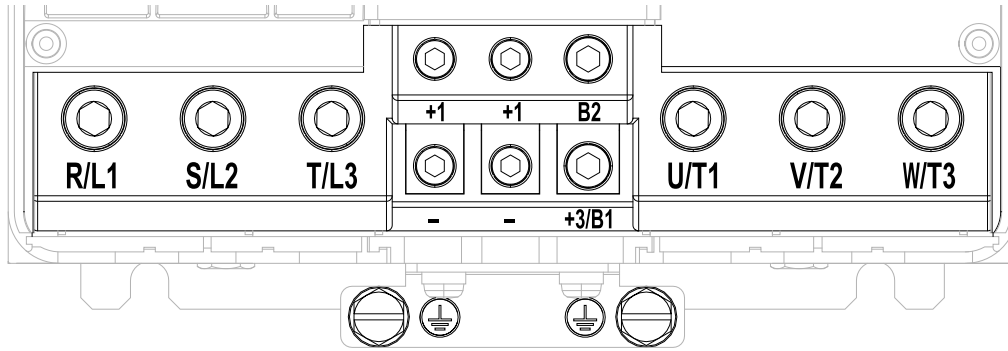

Figure 3.13 Configuration of Main Circuit Terminal Block (2138, 4103)



Note:

The terminals are different for different models:

- 2169, 2211: You cannot use terminal B2. Terminal symbol display “+3/B1” shows terminal +3.
- 4140, 4168: Terminal symbol display “+3/B1” shows terminal B1.

Figure 3.14 Configuration of Main Circuit Terminal Block (2169, 2211, 4140, 4168)

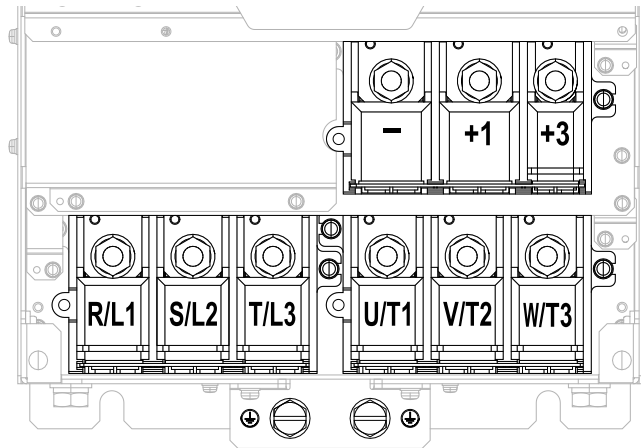

Figure 3.15 Configuration of Main Circuit Terminal Block (2257, 2313, 4208 - 4296)

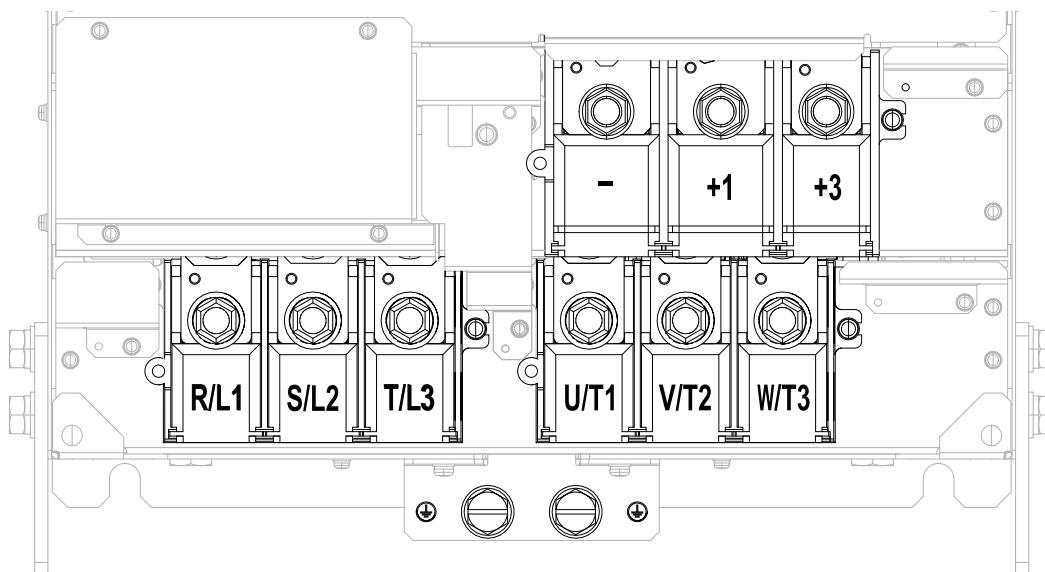

Figure 3.16 Configuration of Main Circuit Terminal Block (2360, 2415, 4371, 4389)

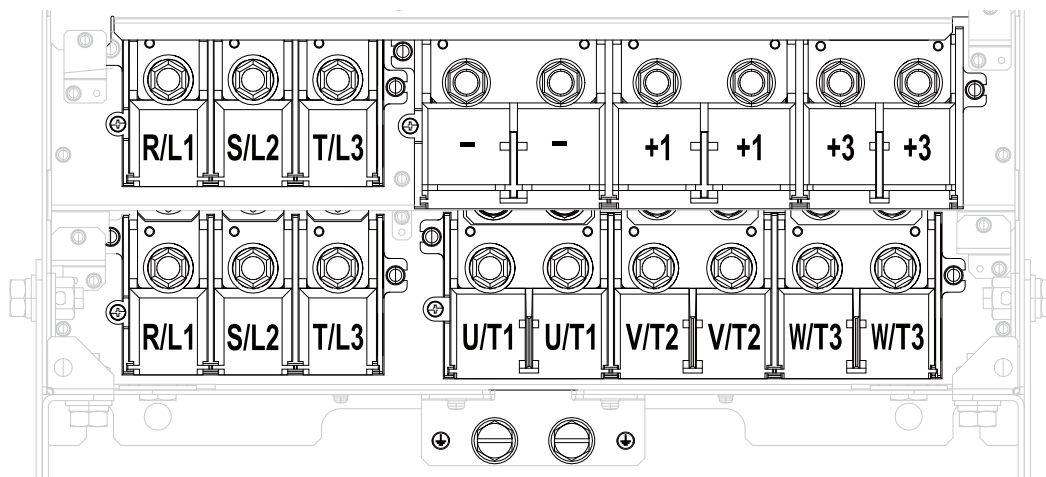

Figure 3.17 Configuration of Main Circuit Terminal Block (4453 - 4675)

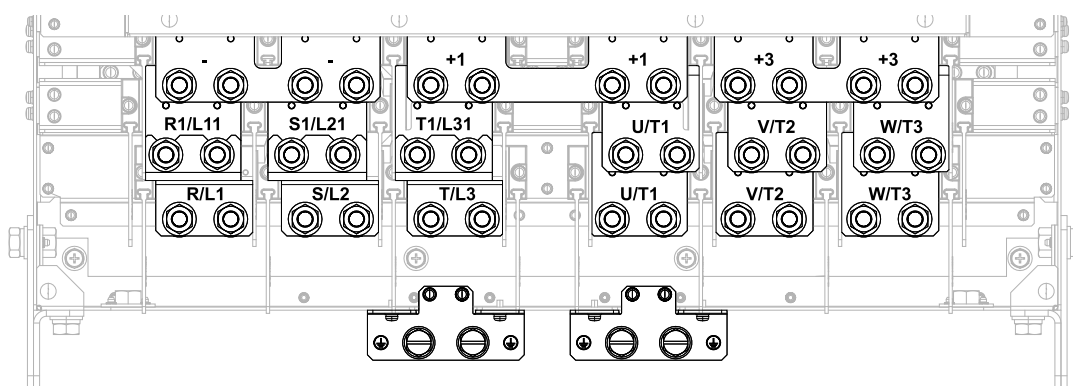

Figure 3.18 Configuration of Main Circuit Terminal Block (4810 - 4H12)

◆ Main Circuit Terminal Functions

Refer to [Table 3.2](#) for the functions of drive main circuit terminals.

Table 3.2 Main Circuit Terminal Functions

Terminal	Name				Function
	2004 - 2082 4002 - 4044	2110 - 2138 4060 - 4168	2169 - 2415 4208 - 4675	- 4810 - 4H12	
R/L1	Main circuit power supply input				To connect a commercial power supply.
S/L2					
T/L3					
R1/L11	-		Main circuit power supply input		To connect a commercial power supply.
S1/L12					
T1/L13					
U/T1	Drive output				To connect a motor.
V/T2					
W/T3					
B1	Braking resistor connection		-		To connect a braking resistor or braking resistor unit.
B2					

3.3 Main Circuit Wiring

Terminal	Name				Function
	2004 - 2082	2110 - 2138	2169 - 2415	-	
	4002 - 4044	4060 - 4168	4208 - 4675	4810 - 4H12	
+2	<ul style="list-style-type: none"> DC power supply input (+1 and -) DC reactor connection (+1 and +2) 	DC power supply input (+1 and -)	-		To connect peripheral devices, for example: <ul style="list-style-type: none"> DC power input Braking Unit DC reactor Note: Remove the jumper between terminals +1 and +2 to connect a DC reactor.
+1					
-					
+3	-		<ul style="list-style-type: none"> DC power supply input (+1 and -) Braking unit connection (+3 and -) 		
	<ul style="list-style-type: none"> 200 V: D class grounding (ground to 100 Ω or less) 400 V: C class grounding (ground to 10 Ω or less) 				To ground the drive.

Note:

Use terminals - and B1 to connect a CDBR-type control unit to drive models 2004 to 2138 and 4002 to 4168 that have built-in braking transistors.

◆ Wire Selection

Select the correct wires for main circuit wiring.

Refer to [Main Circuit Wire Gauges and Tightening Torques on page 234](#) for wire gauges and tightening torques as specified by European standards.

Refer to [Main Circuit Wire Gauges and Tightening Torques on page 262](#) for wire gauges and tightening torques as specified by UL standards.

■ Wire Selection Precautions

WARNING! Crush Hazard.

Make sure that the protective ground wire complies with technical standards and local safety regulations. The IEC/EN 61800-5-1 standard specifies that you must wire the power supply to automatically de-energize when the protective ground wire disconnects. You can also connect a protective ground wire that has a minimum cross-sectional area of 10 mm² (copper wire) or 16 mm² (aluminum wire). The leakage current of the drive will be more than 3.5 mA in drive models;

- 2xxxB
- 2xxxC
- 4002B to 4371B
- 4002C to 4371C (with built-in EMC filter turned ON)
- 4389 to 4H12

If you do not obey the standards and regulations, it can cause serious injury or death.

Think about line voltage drop before selecting wire gauges. Select wire gauges that drop the voltage by 2% or less of the rated voltage. Increase the wire gauge and the cable length when the risk of voltage drops increases.

Calculate line voltage drop with this formula:

$$\text{Line voltage drop (V)} = \sqrt{3} \times \text{wire resistance } (\Omega/\text{km}) \times \text{wiring distance (m)} \times \text{motor rated current (A)} \times 10^{-3}.$$

■ Precautions during Wiring

- Use terminals B1 and - to connect braking units to drives that have built-in braking transistors (models 2004 to 2138 and 4002 to 4168). Use terminals +3 and - to connect braking units to drives that do not have built-in braking transistors.
- Refer to “Yaskawa AC Drive Option Braking Unit, Braking Resistor Unit Instruction Manual (TOBPC72060001)” for information about wire gauges and tightening torques to connect braking resistor units or braking units.
- Use terminals +1 and - to connect a regenerative converter or regenerative unit.

WARNING! Fire Hazard. Do not connect a braking resistor to terminals +1 or -. Use terminals B1 and B2 for the braking resistor connections. If you connect a braking resistor to the incorrect terminals, it can cause damage to the drive and braking circuit and serious injury or death.

■ Main Circuit Wire Gauges and Tightening Torques

WARNING! Crush Hazard.

Make sure that the protective ground wire complies with technical standards and local safety regulations. The IEC/EN 61800-5-1 standard specifies that you must wire the power supply to automatically de-energize when the protective ground wire disconnects. You can also connect a protective ground wire that has a minimum cross-sectional area of 10 mm² (copper wire) or 16 mm² (aluminum wire). The leakage current of the drive will be more than 3.5 mA in drive models;

- 2xxxB
- 2xxxC
- 4002B to 4371B
- 4002C to 4371C (with built-in EMC filter turned ON)
- 4389 to 4H12

If you do not obey the standards and regulations, it can cause serious injury or death.

Note:

- The recommended wire gauges are based on drive continuous current ratings with 75 °C (167 °F) 600 V class 2 heat-resistant indoor PVC wire. Assume these conditions:
 - Ambient temperature: 40 °C (104 °F) maximum
 - Wiring distance: 100 m (328 ft) maximum
 - Normal Duty rated current value
- Use terminals +1, +2, +3, -, B1, and B2 to connect a peripheral option such as a DC reactor or a braking resistor. Do not connect other items to these terminals.
- Refer to the instruction manual for each device for recommended wire gauges to connect peripheral devices or options to terminals +1, +2, +3, -, B1, and B2. Contact Yaskawa or your nearest sales representative if the recommended wire gauges for the peripheral devices or options are out of the range of the applicable gauges for the drive.

Three-Phase 200 V Class

Model	Terminal	Recomm. Gauge mm ²	Applicable Gauge (IP20 Applicable Gauge *1) mm ²	Wire Stripping Length *2 mm	Terminal Screw Size and Shape	Tightening Torque N·m (lbf·in)
2004	R/L1, S/L2, T/L3	2.5	2.5 - 10 (2.5 - 10)	10	M4 ⊖	1.5 - 1.7 (13.5 - 15)
	U/T1, V/T2, W/T3	2.5	2.5 - 10 (2.5 - 10)	10	M4 ⊖	1.5 - 1.7 (13.5 - 15)
	-, +1, +2	2.5	2.5 - 16 (2.5 - 16)	18	M5 ⊖	2.3 - 2.5 (19.8 - 22)
	B1, B2	2.5	2.5 - 4 (2.5 - 4)	10	M4 ⊖	1.5 - 1.7 (13.5 - 15)
	⊕	2.5	2.5 - 10 (-)	-	M4 ⊕	1.2 - 1.5 (10.6 - 13.3)
2006	R/L1, S/L2, T/L3	2.5	2.5 - 10 (2.5 - 10)	10	M4 ⊖	1.5 - 1.7 (13.5 - 15)
	U/T1, V/T2, W/T3	2.5	2.5 - 10 (2.5 - 10)	10	M4 ⊖	1.5 - 1.7 (13.5 - 15)
	-, +1, +2	2.5	2.5 - 16 (2.5 - 16)	18	M5 ⊖	2.3 - 2.5 (19.8 - 22)
	B1, B2	2.5	2.5 - 4 (2.5 - 4)	10	M4 ⊖	1.5 - 1.7 (13.5 - 15)
	⊕	2.5	2.5 - 10 (-)	-	M4 ⊕	1.2 - 1.5 (10.6 - 13.3)
2010	R/L1, S/L2, T/L3	2.5	2.5 - 10 (2.5 - 10)	10	M4 ⊖	1.5 - 1.7 (13.5 - 15)
	U/T1, V/T2, W/T3	2.5	2.5 - 10 (2.5 - 10)	10	M4 ⊖	1.5 - 1.7 (13.5 - 15)
	-, +1, +2	2.5	2.5 - 16 (2.5 - 16)	18	M5 ⊖	2.3 - 2.5 (19.8 - 22)
	B1, B2	2.5	2.5 - 4 (2.5 - 4)	10	M4 ⊖	1.5 - 1.7 (13.5 - 15)
	⊕	2.5	2.5 - 10 (-)	-	M4 ⊕	1.2 - 1.5 (10.6 - 13.3)







3.3 Main Circuit Wiring

Model	Terminal	Recomm. Gauge mm ²	Applicable Gauge (IP20 Applicable Gauge *) mm ²	Wire Stripping Length *2 mm	Terminal Screw Size and Shape	Tightening Torque N·m (lbf·in)
2012	R/L1, S/L2, T/L3	2.5	2.5 - 10 (2.5 - 10)	10	M4 ⊖	1.5 - 1.7 (13.5 - 15)
	U/T1, V/T2, W/T3	2.5	2.5 - 10 (2.5 - 10)	10	M4 ⊖	1.5 - 1.7 (13.5 - 15)
	-, +1, +2	2.5	2.5 - 16 (2.5 - 16)	18	M5 ⊖	2.3 - 2.5 (19.8 - 22)
	B1, B2	2.5	2.5 - 4 (2.5 - 4)	10	M4 ⊖	1.5 - 1.7 (13.5 - 15)
	⊕	2.5	2.5 - 10 (-)	-	M4 ⊕	1.2 - 1.5 (10.6 - 13.3)
2018	R/L1, S/L2, T/L3	2.5	2.5 - 10 (2.5 - 10)	10	M4 ⊖	1.5 - 1.7 (13.5 - 15)
	U/T1, V/T2, W/T3	2.5	2.5 - 10 (2.5 - 10)	10	M4 ⊖	1.5 - 1.7 (13.5 - 15)
	-, +1, +2	4	2.5 - 16 (2.5 - 16)	18	M5 ⊖	2.3 - 2.5 (19.8 - 22)
	B1, B2	2.5	2.5 - 4 (2.5 - 4)	10	M4 ⊖	1.5 - 1.7 (13.5 - 15)
	⊕	2.5	2.5 - 10 (-)	-	M4 ⊕	1.2 - 1.5 (10.6 - 13.3)
2021	R/L1, S/L2, T/L3	6	2.5 - 10 (2.5 - 10)	10	M4 ⊖	1.5 - 1.7 (13.5 - 15)
	U/T1, V/T2, W/T3	2.5	2.5 - 10 (2.5 - 10)	10	M4 ⊖	1.5 - 1.7 (13.5 - 15)
	-, +1, +2	6	2.5 - 16 (2.5 - 16)	18	M5 ⊖	2.3 - 2.5 (19.8 - 22)
	B1, B2	2.5	2.5 - 4 (2.5 - 4)	10	M4 ⊖	1.5 - 1.7 (13.5 - 15)
	⊕	6	4 - 10 (-)	-	M4 ⊕	1.2 - 1.5 (10.6 - 13.3)
2030	R/L1, S/L2, T/L3	10	2.5 - 10 (2.5 - 10)	10	M4 ⊖	1.5 - 1.7 (13.5 - 15)
	U/T1, V/T2, W/T3	6	2.5 - 10 (2.5 - 10)	10	M4 ⊖	1.5 - 1.7 (13.5 - 15)
	-, +1, +2	10	2.5 - 16 (2.5 - 16)	18	M5 ⊖	2.3 - 2.5 (19.8 - 22)
	B1, B2	2.5	2.5 - 4 (2.5 - 4)	10	M4 ⊖	1.5 - 1.7 (13.5 - 15)
	⊕	10	6 - 10 (-)	-	M5 ⊕	2.0 - 2.5 (17.7 - 22.1)
2042	R/L1, S/L2, T/L3	10	2.5 - 10 (2.5 - 10)	10	M4 ⊖	1.5 - 1.7 (13.5 - 15)
	U/T1, V/T2, W/T3	10	2.5 - 10 (2.5 - 10)	10	M4 ⊖	1.5 - 1.7 (13.5 - 15)
	-, +1, +2	16	2.5 - 16 (2.5 - 16)	18	M5 ⊖	2.3 - 2.5 (19.8 - 22)
	B1, B2	4	2.5 - 4 (2.5 - 4)	10	M4 ⊖	1.5 - 1.7 (13.5 - 15)
	⊕	10	6 - 10 (-)	-	M5 ⊕	2.0 - 2.5 (17.7 - 22.1)

Model	Terminal	Recomm. Gauge mm ²	Applicable Gauge (IP20 Applicable Gauge *) mm ²	Wire Stripping Length *2 mm	Terminal Screw Size and Shape	Tightening Torque N·m (lbf·in)
2056	R/L1, S/L2, T/L3	25	2.5 - 25 (10 - 25)	18	M5	2.3 - 2.5 (19.8 - 22)
	U/T1, V/T2, W/T3	16	2.5 - 16 (6 - 16)	18	M5	2.3 - 2.5 (19.8 - 22)
	-, +1, +2	35	2.5 - 35 (10 - 35)	20	M6	5 - 5.5 (45 - 49)
	B1, B2	10	2.5 - 10 (2.5 - 10)	10	M4	1.5 - 1.7 (13.5 - 15)
		16	10 - 16 (-)	-	M6	5.4 - 6.0 (47.8 - 53.1)
2070	R/L1, S/L2, T/L3	35	2.5 - 35 (25 - 35)	20	M6	5 - 5.5 (45 - 49)
	U/T1, V/T2, W/T3	16	2.5 - 16 (16)	20	M6	5 - 5.5 (45 - 49)
	-, +1, +2	50	2.5 - 50 (35 - 50)	20	M6	5 - 5.5 (45 - 49)
	B1, B2	10	2.5 - 10 (2.5 - 10)	10	M4	1.5 - 1.7 (13.5 - 15)
		16	16 - 25 (-)	-	M6	5.4 - 6.0 (47.8 - 53.1)
2082	R/L1, S/L2, T/L3	35	2.5 - 35 (25 - 35)	20	M6	5 - 5.5 (45 - 49)
	U/T1, V/T2, W/T3	25	2.5 - 25 (16 - 25)	20	M6	5 - 5.5 (45 - 49)
	-, +1, +2	50	2.5 - 50 (35 - 50)	20	M6	5 - 5.5 (45 - 49)
	B1, B2	16	2.5 - 16 (2.5 - 16)	10	M4	1.5 - 1.7 (13.5 - 15)
		16	16 - 25 (-)	-	M6	5.4 - 6.0 (47.8 - 53.1)
2110	R/L1, S/L2, T/L3	35	16 - 35 (25 - 35)	27	M6	8 - 9 (71 - 80)
	U/T1, V/T2, W/T3	35	16 - 35 (25 - 35)	27	M6	8 - 9 (71 - 80)
	-, +1	50	25 - 50 (25 - 50)	27	M8	10 - 12 (89 - 107)
	B1, B2	25	6 - 25 (6 - 25)	21	M6	3 - 3.5 (27 - 31)
		16	16 - 25 (-)	-	M6	5.4 - 6.0 (47.8 - 53.1)
2138	R/L1, S/L2, T/L3	50	16 - 50 (50)	27	M6	8 - 9 (71 - 80)
	U/T1, V/T2, W/T3	50	16 - 50 (50)	27	M6	8 - 9 (71 - 80)
	-, +1	70	25 - 70 (50 - 70)	27	M8	10 - 12 (89 - 107)
	B1, B2	35	6 - 35 (6 - 35)	21	M6	3 - 3.5 (27 - 31)
		25	25 (-)	-	M6	5.4 - 6.0 (47.8 - 53.1)

3.3 Main Circuit Wiring

Model	Terminal	Recomm. Gauge mm ²	Applicable Gauge (IP20 Applicable Gauge *) mm ²	Wire Stripping Length *2 mm	Terminal Screw Size and Shape	Tightening Torque N·m (lbf·in)
2169	R/L1, S/L2, T/L3	70	50 - 95 (95)	37	M10	12 - 14 (107 - 124)
	U/T1, V/T2, W/T3	70	50 - 95 (95)	37	M10	12 - 14 (107 - 124)
	-, -, +1, +1 *3 *4	35	16 - 50 (50)	28	M6	8 - 9 (71 - 80)
	+3 *4	50	25 - 70 (50 - 70)	28	M8	8 - 9 (71 - 80)
		35	25 - 50 (-)	-	M8	9.0 - 11 (79.7 - 97.4)
2211	R/L1, S/L2, T/L3	95	50 - 95 (95)	37	M10	12 - 14 (107 - 124)
	U/T1, V/T2, W/T3	95	50 - 95 (95)	37	M10	12 - 14 (107 - 124)
	-, -, +1, +1 *3 *4	50	16 - 50 (50)	28	M6	8 - 9 (71 - 80)
	+3 *4	70	25 - 70 (50 - 70)	28	M8	8 - 9 (71 - 80)
		50	25 - 50 (-)	-	M8	9.0 - 11 (79.7 - 97.4)
2257	R/L1, S/L2, T/L3	50 × 2P	25 - 95 × 2P (70 - 95 × 2P)	-	M10	20 (177)
	U/T1, V/T2, W/T3	50 × 2P	25 - 95 × 2P (70 - 95 × 2P)	-	M10	20 (177)
	-, +1	70 × 2P	35 - 120 × 2P (120 × 2P)	-	M10	20 (177)
	+3	35 × 2P	25 - 70 × 2P (70 × 2P)	-	M10	20 (177)
		95	95 - 240 (-)	-	M10	18 - 23 (159 - 204)
2313	R/L1, S/L2, T/L3	70 × 2P	25 - 95 × 2P (70 - 95 × 2P)	-	M10	20 (177)
	U/T1, V/T2, W/T3	70 × 2P	25 - 95 × 2P (70 - 95 × 2P)	-	M10	20 (177)
	-, +1	95 × 2P	35 - 120 × 2P (120 × 2P)	-	M10	20 (177)
	+3	50 × 2P	25 - 70 × 2P (70 × 2P)	-	M10	20 (177)
		95	95 - 240 (-)	-	M10	18 - 23 (159 - 204)
2360	R/L1, S/L2, T/L3	120 × 2P	70 - 150 × 2P (150 × 2P)	-	M12	35 (310)
	U/T1, V/T2, W/T3	120 × 2P	70 - 150 × 2P (150 × 2P)	-	M12	35 (310)
	-, +1	120 × 2P	95 - 185 × 2P (185 × 2P)	-	M12	35 (310)
	+3	70 × 2P	50 - 95 × 2P (-)	-	M12	35 (310)
		120	120 - 240 (-)	-	M12	32 - 40 (283 - 354)

Model	Terminal	Recomm. Gauge mm ²	Applicable Gauge (IP20 Applicable Gauge *1) mm ²	Wire Stripping Length *2 mm	Terminal Screw Size and Shape	Tightening Torque N·m (lbf·in)
2415	R/L1, S/L2, T/L3	120 × 2P	70 - 150 × 2P (150 × 2P)	-	M12 	35 (310)
	U/T1, V/T2, W/T3	120 × 2P	70 - 150 × 2P (150 × 2P)	-	M12 	35 (310)
	-, +1	120 × 2P	95 - 185 × 2P (185 × 2P)	-	M12 	35 (310)
	+3	70 × 2P	50 - 95 × 2P (-)	-	M12 	35 (310)
		120	120 - 240 (-)	-	M12 	32 - 40 (283 - 354)















*1 For IP20 protection, use wires that are in the range of applicable gauges.

*2 Remove insulation from the ends of wires to expose the length of wire shown.

*3 Terminals - and +1 have two screws. The Recommended Gauge is the wire gauge for one terminal.

*4 A junction terminal is necessary to connect a braking unit (CDBR-series) to terminals - and +3.

Three-Phase 400 V Class

Model	Terminal	Recomm. Gauge mm ²	Applicable Gauge (IP20 Applicable Gauge *1) mm ²	Wire Stripping Length *2 mm	Terminal Screw Size and Shape	Tightening Torque N·m (lbf·in)
4002	R/L1, S/L2, T/L3	2.5	2.5 - 10 (2.5 - 10)	10	M4 	1.5 - 1.7 (13.5 - 15)
	U/T1, V/T2, W/T3	2.5	2.5 - 10 (2.5 - 10)	10	M4 	1.5 - 1.7 (13.5 - 15)
	-, +1, +2	2.5	2.5 - 16 (2.5 - 16)	18	M5 	2.3 - 2.5 (19.8 - 22)
	B1, B2	2.5	2.5 - 4 (2.5 - 4)	10	M4 	1.5 - 1.7 (13.5 - 15)
		2.5	2.5 - 10 (-)	-	M4 	1.2 - 1.5 (10.6 - 13.3)
4004	R/L1, S/L2, T/L3	2.5	2.5 - 10 (2.5 - 10)	10	M4 	1.5 - 1.7 (13.5 - 15)
	U/T1, V/T2, W/T3	2.5	2.5 - 10 (2.5 - 10)	10	M4 	1.5 - 1.7 (13.5 - 15)
	-, +1, +2	2.5	2.5 - 16 (2.5 - 16)	18	M5 	2.3 - 2.5 (19.8 - 22)
	B1, B2	2.5	2.5 - 4 (2.5 - 4)	10	M4 	1.5 - 1.7 (13.5 - 15)
		2.5	2.5 - 10 (-)	-	M4 	1.2 - 1.5 (10.6 - 13.3)
4005	R/L1, S/L2, T/L3	2.5	2.5 - 10 (2.5 - 10)	10	M4 	1.5 - 1.7 (13.5 - 15)
	U/T1, V/T2, W/T3	2.5	2.5 - 10 (2.5 - 10)	10	M4 	1.5 - 1.7 (13.5 - 15)
	-, +1, +2	2.5	2.5 - 16 (2.5 - 16)	18	M5 	2.3 - 2.5 (19.8 - 22)
	B1, B2	2.5	2.5 - 4 (2.5 - 4)	10	M4 	1.5 - 1.7 (13.5 - 15)
		2.5	2.5 - 10 (-)	-	M4 	1.2 - 1.5 (10.6 - 13.3)































3.3 Main Circuit Wiring

Model	Terminal	Recomm. Gauge mm ²	Applicable Gauge (IP20 Applicable Gauge *) mm ²	Wire Stripping Length *2 mm	Terminal Screw Size and Shape	Tightening Torque N·m (lbf·in)
4007	R/L1, S/L2, T/L3	2.5	2.5 - 10 (2.5 - 10)	10	M4 ⊖	1.5 - 1.7 (13.5 - 15)
	U/T1, V/T2, W/T3	2.5	2.5 - 10 (2.5 - 10)	10	M4 ⊖	1.5 - 1.7 (13.5 - 15)
	-, +1, +2	2.5	2.5 - 16 (2.5 - 16)	18	M5 ⊖	2.3 - 2.5 (19.8 - 22)
	B1, B2	2.5	2.5 - 4 (2.5 - 4)	10	M4 ⊖	1.5 - 1.7 (13.5 - 15)
	⊥	2.5	2.5 - 10 (-)	-	M4 ⊕	1.2 - 1.5 (10.6 - 13.3)
4009	R/L1, S/L2, T/L3	2.5	2.5 - 10 (2.5 - 10)	10	M4 ⊖	1.5 - 1.7 (13.5 - 15)
	U/T1, V/T2, W/T3	2.5	2.5 - 10 (2.5 - 10)	10	M4 ⊖	1.5 - 1.7 (13.5 - 15)
	-, +1, +2	2.5	2.5 - 16 (2.5 - 16)	18	M5 ⊖	2.3 - 2.5 (19.8 - 22)
	B1, B2	2.5	2.5 - 4 (2.5 - 4)	10	M4 ⊖	1.5 - 1.7 (13.5 - 15)
	⊥	2.5	2.5 - 10 (-)	-	M4 ⊕	1.2 - 1.5 (10.6 - 13.3)
4012	R/L1, S/L2, T/L3	2.5	2.5 - 10 (2.5 - 10)	10	M4 ⊖	1.5 - 1.7 (13.5 - 15)
	U/T1, V/T2, W/T3	2.5	2.5 - 10 (2.5 - 10)	10	M4 ⊖	1.5 - 1.7 (13.5 - 15)
	-, +1, +2	2.5	2.5 - 16 (2.5 - 16)	18	M5 ⊖	2.3 - 2.5 (19.8 - 22)
	B1, B2	2.5	2.5 - 4 (2.5 - 4)	10	M4 ⊖	1.5 - 1.7 (13.5 - 15)
	⊥	2.5	2.5 - 10 (-)	-	M4 ⊕	1.2 - 1.5 (10.6 - 13.3)
4018	R/L1, S/L2, T/L3	2.5	2.5 - 10 (2.5 - 10)	10	M4 ⊖	1.5 - 1.7 (13.5 - 15)
	U/T1, V/T2, W/T3	2.5	2.5 - 10 (2.5 - 10)	10	M4 ⊖	1.5 - 1.7 (13.5 - 15)
	-, +1, +2	4	2.5 - 16 (2.5 - 16)	18	M5 ⊖	2.3 - 2.5 (19.8 - 22)
	B1, B2	2.5	2.5 - 4 (2.5 - 4)	10	M4 ⊖	1.5 - 1.7 (13.5 - 15)
	⊥	2.5	2.5 - 10 (-)	-	M5 ⊕	2.0 - 2.5 (17.7 - 22.1)
4023	R/L1, S/L2, T/L3	6	2.5 - 10 (2.5 - 10)	10	M4 ⊖	1.5 - 1.7 (13.5 - 15)
	U/T1, V/T2, W/T3	4	2.5 - 10 (2.5 - 10)	10	M4 ⊖	1.5 - 1.7 (13.5 - 15)
	-, +1, +2	6	2.5 - 16 (2.5 - 16)	18	M5 ⊖	2.3 - 2.5 (19.8 - 22)
	B1, B2	2.5	2.5 - 4 (2.5 - 4)	10	M4 ⊖	1.5 - 1.7 (13.5 - 15)
	⊥	6	4 - 10 (-)	-	M5 ⊕	2.0 - 2.5 (17.7 - 22.1)































Model	Terminal	Recomm. Gauge mm ²	Applicable Gauge (IP20 Applicable Gauge *) mm ²	Wire Stripping Length ^{*)2} mm	Terminal Screw Size and Shape	Tightening Torque N·m (lbf·in)
4031	R/L1, S/L2, T/L3	10	2.5 - 25 (10 - 25)	18	M5 ⊖	2.3 - 2.5 (19.8 - 22)
	U/T1, V/T2, W/T3	6	2.5 - 16 (6 - 16)	18	M5 ⊖	2.3 - 2.5 (19.8 - 22)
	-, +1, +2	10	2.5 - 35 (10 - 35)	20	M6 ⊕	5 - 5.5 (45 - 49)
	B1, B2	2.5	2.5 - 10 (2.5 - 10)	10	M4 ⊖	1.5 - 1.7 (13.5 - 15)
	⊕	10	6 - 16 (-)	-	M6 ⊕	5.4 - 6.0 (47.8 - 53.1)
4038	R/L1, S/L2, T/L3	10	2.5 - 25 (10 - 25)	18	M5 ⊖	2.3 - 2.5 (19.8 - 22)
	U/T1, V/T2, W/T3	6	2.5 - 16 (6 - 16)	18	M5 ⊖	2.3 - 2.5 (19.8 - 22)
	-, +1, +2	16	2.5 - 35 (10 - 35)	20	M6 ⊕	5 - 5.5 (45 - 49)
	B1, B2	4	2.5 - 10 (2.5 - 10)	10	M4 ⊖	1.5 - 1.7 (13.5 - 15)
	⊕	10	6 - 16 (-)	-	M6 ⊕	5.4 - 6.0 (47.8 - 53.1)
4044	R/L1, S/L2, T/L3	16	2.5 - 16 (4 - 16)	18	M5 ⊖	2.3 - 2.5 (19.8 - 22)
	U/T1, V/T2, W/T3	10	2.5 - 10 (6 - 10)	18	M5 ⊖	2.3 - 2.5 (19.8 - 22)
	-, +1, +2	25	2.5 - 25 (6 - 25)	18	M5 ⊖	2.3 - 2.5 (19.8 - 22)
	B1, B2	6	2.5 - 6 (2.5 - 6)	10	M4 ⊖	1.5 - 1.7 (13.5 - 15)
	⊕	16	10 - 25 (-)	-	M6 ⊕	5.4 - 6.0 (47.8 - 53.1)
4060	R/L1, S/L2, T/L3	16	2.5 - 16 (4 - 16)	18	M5 ⊖	2.3 - 2.5 (19.8 - 22)
	U/T1, V/T2, W/T3	16	2.5 - 16 (6 - 16)	18	M5 ⊖	2.3 - 2.5 (19.8 - 22)
	-, +1	25	2.5 - 25 (6 - 25)	18	M5 ⊖	2.3 - 2.5 (19.8 - 22)
	B1, B2	10	2.5 - 10 (2.5 - 10)	10	M4 ⊖	1.5 - 1.7 (13.5 - 15)
	⊕	16	10 - 25 (-)	-	M6 ⊕	5.4 - 6.0 (47.8 - 53.1)
4075	R/L1, S/L2, T/L3	25	2.5 - 25 (2.5 - 25)	18	M5 ⊖	2.3 - 2.5 (19.8 - 22)
	U/T1, V/T2, W/T3	25	2.5 - 25 (2.5 - 25)	18	M5 ⊖	2.3 - 2.5 (19.8 - 22)
	-, +1	25	2.5 - 25 (4 - 25)	18	M5 ⊖	2.3 - 2.5 (19.8 - 22)
	B1, B2	10	2.5 - 10 (2.5 - 10)	10	M4 ⊖	1.5 - 1.7 (13.5 - 15)
	⊕	16	16 - 25 (-)	-	M6 ⊕	5.4 - 6.0 (47.8 - 53.1)







3.3 Main Circuit Wiring

Model	Terminal	Recomm. Gauge mm ²	Applicable Gauge (IP20 Applicable Gauge *) mm ²	Wire Stripping Length *2 mm	Terminal Screw Size and Shape	Tightening Torque N·m (lbf·in)
4089	R/L1, S/L2, T/L3	25	2.5 - 25 (10 - 25)	18	M5	2.3 - 2.5 (19.8 - 22)
	U/T1, V/T2, W/T3	25	2.5 - 25 (10 - 25)	18	M5	2.3 - 2.5 (19.8 - 22)
	-, +1	35	2.5 - 35 (16 - 35)	20	M6	5 - 5.5 (45 - 49)
	B1, B2	16	2.5 - 16 (4 - 16)	18	M5	2.3 - 2.5 (19.8 - 22)
		16	16 - 25 (-)	-	M6	5.4 - 6.0 (47.8 - 53.1)
4103	R/L1, S/L2, T/L3	35	16 - 50 (50)	27	M6	8 - 9 (71 - 80)
	U/T1, V/T2, W/T3	35	16 - 50 (50)	27	M6	8 - 9 (71 - 80)
	-, +1	50	25 - 70 (50 - 70)	27	M8	10 - 12 (89 - 107)
	B1, B2	25	6 - 35 (6 - 35)	21	M6	3 - 3.5 (27 - 31)
		16	16 - 25 (-)	-	M6	5.4 - 6.0 (47.8 - 53.1)
4140	R/L1, S/L2, T/L3	50	50 - 95 (95)	37	M10	12 - 14 (107 - 124)
	U/T1, V/T2, W/T3	50	50 - 95 (95)	37	M10	12 - 14 (107 - 124)
	-, -, +1, +1 *3	25	16 - 50 (50)	28	M6	8 - 9 (71 - 80)
	B1, B2 *4	50	25 - 70 (50 - 70)	28	M8	8 - 9 (71 - 80)
		25	25 - 50 (-)	-	M8	9.0 - 11 (79.7 - 97.4)
4168	R/L1, S/L2, T/L3	70	50 - 95 (95)	37	M10	12 - 14 (107 - 124)
	U/T1, V/T2, W/T3	70	50 - 95 (95)	37	M10	12 - 14 (107 - 124)
	-, -, +1, +1 *3	35	16 - 50 (50)	28	M6	8 - 9 (71 - 80)
	B1, B2 *4	50	25 - 70 (50 - 70)	28	M8	8 - 9 (71 - 80)
		35	25 - 50 (-)	-	M8	9.0 - 11 (79.7 - 97.4)
4208	R/L1, S/L2, T/L3	50 × 2P	25 - 95 × 2P (70 - 95 × 2P)	-	M10	20 (177)
	U/T1, V/T2, W/T3	50 × 2P	25 - 95 × 2P (70 - 95 × 2P)	-	M10	20 (177)
	-, +1	70 × 2P	35 - 120 × 2P (120 × 2P)	-	M10	20 (177)
	+3	35 × 2P	25 - 70 × 2P (70 × 2P)	-	M10	20 (177)
		50	50 - 240 (-)	-	M10	18 - 23 (159 - 204)

Model	Terminal	Recomm. Gauge mm ²	Applicable Gauge (IP20 Applicable Gauge *) mm ²	Wire Stripping Length ^{*)2} mm	Terminal Screw Size and Shape	Tightening Torque N·m (lbf·in)
4250	R/L1, S/L2, T/L3	50 × 2P	25 - 95 × 2P (70 - 95 × 2P)	-	M10 	20 (177)
	U/T1, V/T2, W/T3	50 × 2P	25 - 95 × 2P (70 - 95 × 2P)	-	M10 	20 (177)
	-, +1	70 × 2P	35 - 120 × 2P (120 × 2P)	-	M10 	20 (177)
	+3	50 × 2P	25 - 70 × 2P (70 × 2P)	-	M10 	20 (177)
		70	70 - 240 (-)	-	M10 	18 - 23 (159 - 204)
4296	R/L1, S/L2, T/L3	70 × 2P	25 - 95 × 2P (70 - 95 × 2P)	-	M10 	20 (177)
	U/T1, V/T2, W/T3	70 × 2P	25 - 95 × 2P (70 - 95 × 2P)	-	M10 	20 (177)
	-, +1	95 × 2P	35 - 120 × 2P (120 × 2P)	-	M10 	20 (177)
	+3	70 × 2P	25 - 70 × 2P (70 × 2P)	-	M10 	20 (177)
		95	95 - 240 (-)	-	M10 	18 - 23 (159 - 204)
4371	R/L1, S/L2, T/L3	120 × 2P	70 - 150 × 2P (150 × 2P)	-	M12 	35 (310)
	U/T1, V/T2, W/T3	120 × 2P	70 - 150 × 2P (150 × 2P)	-	M12 	35 (310)
	-, +1	120 × 2P	95 - 185 × 2P (185 × 2P)	-	M12 	35 (310)
	+3	70 × 2P	50 - 95 × 2P (-)	-	M12 	35 (310)
		120	120 - 240 (-)	-	M12 	32 - 40 (283 - 354)
4389	R/L1, S/L2, T/L3	120 × 2P	70 - 150 × 2P (150 × 2P)	-	M12 	35 (310)
	U/T1, V/T2, W/T3	120 × 2P	70 - 150 × 2P (150 × 2P)	-	M12 	35 (310)
	-, +1	120 × 2P	95 - 185 × 2P (185 × 2P)	-	M12 	35 (310)
	+3	95 × 2P	50 - 95 × 2P (-)	-	M12 	35 (310)
		95	35 - 240 (-)	-	M12 	32 - 40 (283 - 354)
4453	R/L1, S/L2, T/L3	120 × 4P	70 - 150 × 4P (150 × 4P)	-	M12 	35 (310)
	U/T1, V/T2, W/T3	95 × 4P	70 - 150 × 4P (120 - 150 × 4P)	-	M12 	35 (310)
	-, +1	95 × 4P	95 - 185 × 4P (185 × 4P)	-	M12 	35 (310)
	+3	70 × 4P	35 - 95 × 4P (95 × 4P)	-	M12 	35 (310)
		150	50 - 150 (-)	-	M12 	32 - 40 (283 - 354)

3.3 Main Circuit Wiring

Model	Terminal	Recomm. Gauge mm ²	Applicable Gauge (IP20 Applicable Gauge *) mm ²	Wire Stripping Length *2 mm	Terminal Screw Size and Shape	Tightening Torque N·m (lbf·in)
4568	R/L1, S/L2, T/L3	120 × 4P	70 - 150 × 4P (150 × 4P)	-	M12 	35 (310)
	U/T1, V/T2, W/T3	95 × 4P	70 - 150 × 4P (120 - 150 × 4P)	-	M12 	35 (310)
	-, +1	95 × 4P	95 - 185 × 4P (185 × 4P)	-	M12 	35 (310)
	+3	70 × 4P	35 - 95 × 4P (95 × 4P)	-	M12 	35 (310)
		95 × 2P	60 - 150 (-)	-	M12 	32 - 40 (283 - 354)
4675	R/L1, S/L2, T/L3	120 × 4P	70 - 150 × 4P (150 × 4P)	-	M12 	35 (310)
	U/T1, V/T2, W/T3	95 × 4P	70 - 150 × 4P (120 - 150 × 4P)	-	M12 	35 (310)
	-, +1	95 × 4P	95 - 185 × 4P (185 × 4P)	-	M12 	35 (310)
	+3	70 × 4P	35 - 95 × 4P (95 × 4P)	-	M12 	35 (310)
		95 × 2P	60 - 150 (-)	-	M12 	32 - 40 (283 - 354)
4810	R/L1, S/L2, T/L3 R1/L11, S1/L21, T1/L31	120 × 2P × 2	95 - 150 × 2P × 2 (-)	-	M12 	35 (310)
	U/T1, V/T2, W/T3	95 × 2P × 2	70 - 150 × 2P × 2 (-)	-	M12 	35 (310)
	-, +1	150 × 4P	95 - 150 × 4P (-)	-	M12 	35 (310)
	+3	70 × 4P	70 - 150 × 4P (-)	-	M12 	35 (310)
		120 × 2P	70 - 120 (-)	-	M12 	32 - 40 (283 - 354)
4930	R/L1, S/L2, T/L3 R1/L11, S1/L21, T1/L31	120 × 2P × 2	95 - 150 × 2P × 2 (-)	-	M12 	35 (310)
	U/T1, V/T2, W/T3	120 × 2P × 2	95 - 150 × 2P × 2 (-)	-	M12 	35 (310)
	-, +1	150 × 4P	95 - 150 × 4P (-)	-	M12 	35 (310)
	+3	95 × 4P	70 - 150 × 4P (-)	-	M12 	35 (310)
		120 × 2P	70 - 120 (-)	-	M12 	32 - 40 (283 - 354)
4H11	R/L1, S/L2, T/L3 R1/L11, S1/L21, T1/L31	95 × 4P × 2	95 - 150 × 4P × 2 (-)	-	M12 	35 (310)
	U/T1, V/T2, W/T3	50 × 4P × 2	35 - 150 × 4P × 2 (-)	-	M12 	35 (310)
	-, +1	70 × 4P × 2	70 - 150 × 4P × 2 (-)	-	M12 	35 (310)
	+3	35 × 4P × 2	35 - 150 × 4P × 2 (-)	-	M12 	35 (310)
		95 × 4P	95 - 120 (-)	-	M12 	32 - 40 (283 - 354)

Model	Terminal	Recomm. Gauge mm ²	Applicable Gauge (IP20 Applicable Gauge *) mm ²	Wire Stripping Length *2 mm	Terminal Screw Size and Shape	Tightening Torque N·m (lbf·in)
4H12	R/L1, S/L2, T/L3 R1/L11, S1/L21, T1/L31	95 × 4P × 2	95 - 150 × 4P × 2 (-)	-	M12 	35 (310)
	U/T1, V/T2, W/T3	70 × 4P × 2	50 - 150 × 4P × 2 (-)	-	M12 	35 (310)
	-, +1	70 × 4P × 2	70 - 150 × 4P × 2 (-)	-	M12 	35 (310)
	+3	50 × 4P × 2	35 - 150 × 4P × 2 (-)	-	M12 	35 (310)
		95 × 4P	95 - 120 (-)	-	M12 	32 - 40 (283 - 354)



















*1 For IP20 protection, use wires that are in the range of applicable gauges.

*2 Remove insulation from the ends of wires to expose the length of wire shown.







*3 Terminals - and +1 have two screws. The Recommended Gauge is the wire gauge for one terminal.

*4 A junction terminal is necessary to connect a braking resistor unit (LKEB-series) to terminals B1 and B2.

6-Phase/12-Pulse 400 V Class

Model	Terminal	Recomm. Gauge *1 mm ²	Applicable Gauge mm ²	Terminal Screw Size and Shape	Tightening Torque N·m (lbf·in)
4810	R/L1, S/L2, T/L3 R1/L11, S1/L21, T1/L31 *2	120 × 2P (×2)	95 - 150	M12 	35 (310)
	U/T1, V/T2, W/T3	95 × 2P × 2	70 - 150	M12 	35 (310)
	-, +1	150 × 4P	95 - 150	M12 	35 (310)
	+3	70 × 4P	70 - 150	M12 	35 (310)
		120 × 2P	70 - 120	M12 	32 - 40 (283 - 354)
4930	R/L1, S/L2, T/L3 R1/L11, S1/L21, T1/L31 *2	120 × 2P (×2)	95 - 150	M12 	35 (310)
	U/T1, V/T2, W/T3	120 × 2P × 2	95 - 150	M12 	35 (310)
	-, +1	150 × 4P	95 - 150	M12 	35 (310)
	+3	95 × 4P	70 - 150	M12 	35 (310)
		120 × 2P	70 - 120	M12 	32 - 40 (283 - 354)
4H11	R/L1, S/L2, T/L3 R1/L11, S1/L21, T1/L31 *2	95 × 4P (×2)	95 - 150	M12 	35 (310)
	U/T1, V/T2, W/T3	50 × 4P × 2	35 - 150	M12 	35 (310)
	-, +1	70 × 4P × 2	70 - 150	M12 	35 (310)
	+3	35 × 4P × 2	35 - 150	M12 	35 (310)
		95 × 4P	95 - 120	M12 	32 - 40 (283 - 354)

3.3 Main Circuit Wiring

Model	Terminal	Recomm. Gauge ^{*1} mm ²	Applicable Gauge mm ²	Terminal Screw Size and Shape	Tightening Torque N·m (lbf·in)
4H12	R/L1, S/L2, T/L3 R1/L11, S1/L21, T1/L31 ^{*2}	95 × 4P (×2)	95 - 150	M12 	35 (310)
	U/T1, V/T2, W/T3	70 × 4P × 2	50 - 150	M12 	35 (310)
	-, +1	70 × 4P × 2	70 - 150	M12 	35 (310)
	+3	50 × 4P × 2	35 - 150	M12 	35 (310)
		95 × 4P	95 - 120	M12 	32 - 40 (283 - 354)

*1 The wire gauges for drive models 4810 to 4H12 are the recommended wire gauges when you use these drive models as a 6-Phase/12-Pulse drive.

*2 When you use drive models 4810 to 4H12 as a 6-Phase/12-Pulse drive, remove the common bus bars on the input terminals.

◆ Main Circuit Terminal and Motor Wiring

This section outlines the various steps, precautions, and checkpoints for wiring the main circuit terminals and motor terminals.

WARNING! Fire Hazard. Do not connect main power supply wiring to drive motor terminals U/T1, V/T2, and W/T3. Connect main power supply wiring to main circuit input terminals R/L1, S/L2, and T/L3. Incorrect wiring can cause serious injury or death from fire.

WARNING! Sudden Movement Hazard. Make sure that you align the phase order for the drive and motor when you connect the motor to drive output terminals U/T1, V/T2, and W/T3. If the phase order is incorrect, it can cause the motor to run in reverse. If the motor accidentally runs in reverse, it can cause serious injury or death.

NOTICE: Do not connect phase-advancing capacitors, LC/RC noise filters, or leakage breakers (RCM/RCD) to the motor circuit. If you connect these devices to the output circuits, it can cause damage to the drive and connected equipment.

■ Cable Length Between Drive and Motor

When the wiring between the drive and the motor is too long, voltage drop along the motor cable can decrease motor torque, usually at low frequency output. If you connect motors in parallel with long motor cable, this is also a problem. Drive output current increases when the leakage current from the cable increases. An increase in leakage current can cause overcurrent and decrease the precision of the current detection.

Use the values in [Table 3.3](#) to adjust the drive carrier frequency. For systems that have 100 m (328 ft) or longer motor wiring, if you use metal conduits or isolated cables for each phase, it will increase stray capacitance.

Table 3.3 Carrier Frequency against Cable Length Between Drive and Motor

Wiring Distance Between the Drive and Motor	50 m (164 ft) Maximum	100 m (328 ft) Maximum	More than 100 m (328 ft)
Carrier Frequency	15 kHz or less	5 kHz or less	2 kHz or less

Note:

- To set the carrier frequency in a drive that is operating more than one motor, calculate the cable length as the total distance of wiring to all connected motors.
- When $A1-02 = 5, 6$ [OLV/PM, AOLV/PM], the maximum cable length is 100 m (328 ft).
- When you connect to a PM motor, it can be necessary to adjust the overcurrent detection. Refer to [L8-27: Overcurrent Detection Gain on page 953](#) for more information.

■ Ground Wiring

Follow the precautions to wire the ground for one drive or a series of drives.

WARNING! Crush Hazard.

Make sure that the protective ground wire complies with technical standards and local safety regulations. The IEC/EN 61800-5-1 standard specifies that you must wire the power supply to automatically de-energize when the protective ground wire disconnects. You can also connect a protective ground wire that has a minimum cross-sectional area of 10 mm² (copper wire) or 16 mm² (aluminum wire). The leakage current of the drive will be more than 3.5 mA in drive models;

- 2xxxB
- 2xxxC
- 4002B to 4371B
- 4002C to 4371C (with built-in EMC filter turned ON)
- 4389 to 4H12

If you do not obey the standards and regulations, it can cause serious injury or death.

WARNING! Electrical Shock Hazard. Ground the neutral point on the power supply of drive models 2xxxB/C and 4xxxB/C to comply with the EMC Directive before you turn on the EMC filter. If you turn ON the EMC filter, but you do not ground the neutral point, it can cause serious injury or death.

WARNING! Electrical Shock Hazard. Use a ground wire that complies with technical standards on electrical equipment and use the minimum length of ground wire. Incorrect equipment grounding can cause serious injury or death from dangerous electrical potentials on the equipment chassis.

WARNING! Electrical Shock Hazard.

Correctly ground the ground terminals. Obey federal and local electrical wiring codes for correct grounding methods. The maximum grounding resistance is

- 200 V class: ground to 100 Ω or less
- 400 V class: ground to 10 Ω or less

If you touch electrical equipment that is not grounded, it can cause serious injury or death.

Note:

- Only use the drive grounding wire to ground the drive. Do not share the ground wire with other devices such as welding machines or large-current electrical equipment. Incorrect equipment grounding can cause drive or equipment malfunction from electrical interference.
- To connect more than one drive to the same grounding circuit, follow the instructions in the instruction manual. Incorrect equipment grounding can cause drive or equipment malfunction from electrical interference.

When you connect more than one drive, refer to [Figure 3.19](#). Do not loop the grounding wire.

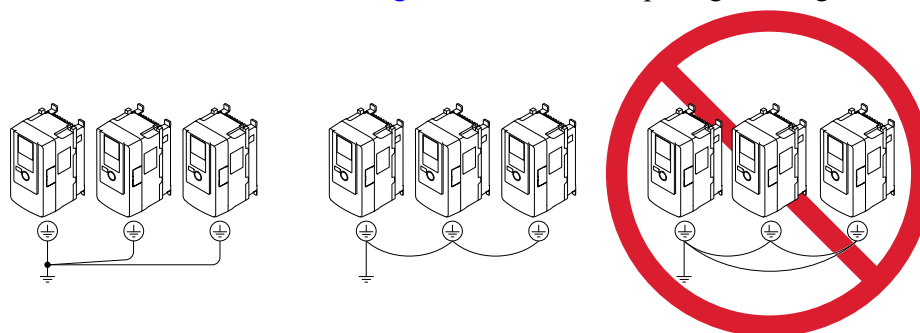

Figure 3.19 Wiring More than One Drive

■ Wiring the Main Circuit Terminal Block

WARNING! Electrical Shock Hazard. Before you wire the main circuit terminals, make sure that MCCB and MC are OFF. If you touch electrical equipment when MCCB and MC are ON, it can cause serious injury or death.

■ Main Circuit Configuration

The figures in this section show the different schematics of the drive main circuit. The connections change when the drive capacity changes. The DC power supply for the main circuit also supplies power to the control circuit.

Note:

Drive models 2004A to 2415A and 4002A to 4H12A do not have a built-in EMC filter.

WARNING! Fire Hazard. Do not connect a braking resistor to terminals +1 or -. Use terminals B1 and B2 for the braking resistor connections. If you connect a braking resistor to the incorrect terminals, it can cause damage to the drive and braking circuit and serious injury or death.

NOTICE: Do not use the negative DC bus terminal “-” as a ground terminal. This terminal is at high DC voltage potential. Incorrect wiring connections can cause damage to the drive.

Model	Figure
2004 - 2082, 4002 - 4044	Figure 3.20
2110 - 2138, 4060 - 4168	Figure 3.21
2169 - 2415, 4208 - 4389	Figure 3.22
4453 - 4H12	Figure 3.23

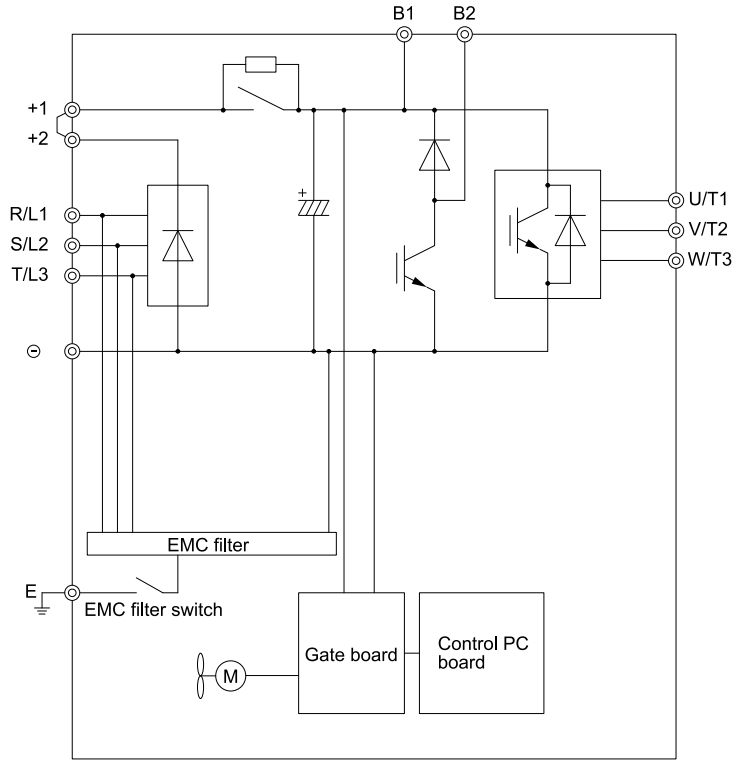

Figure 3.20 Drive Main Circuit Configuration 1

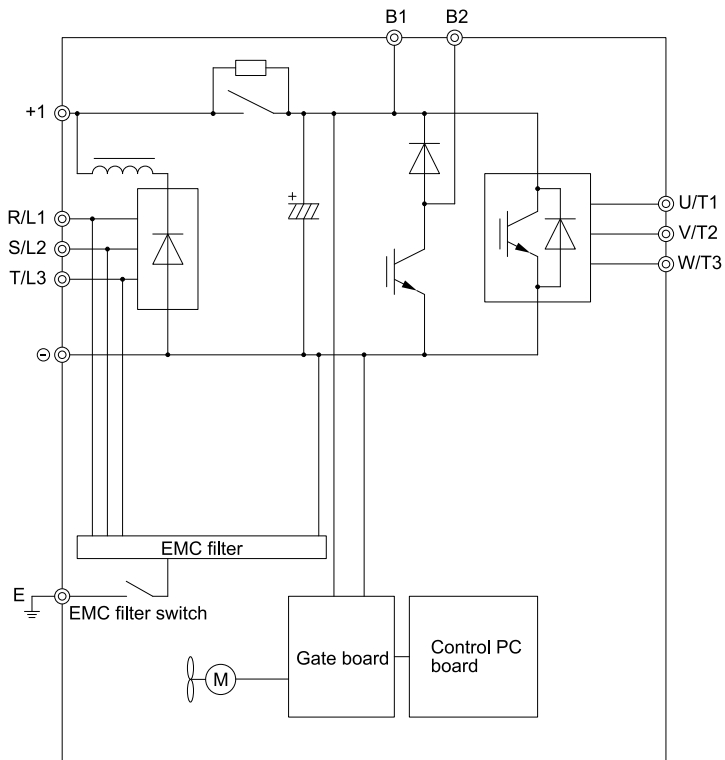

Figure 3.21 Drive Main Circuit Configuration 2

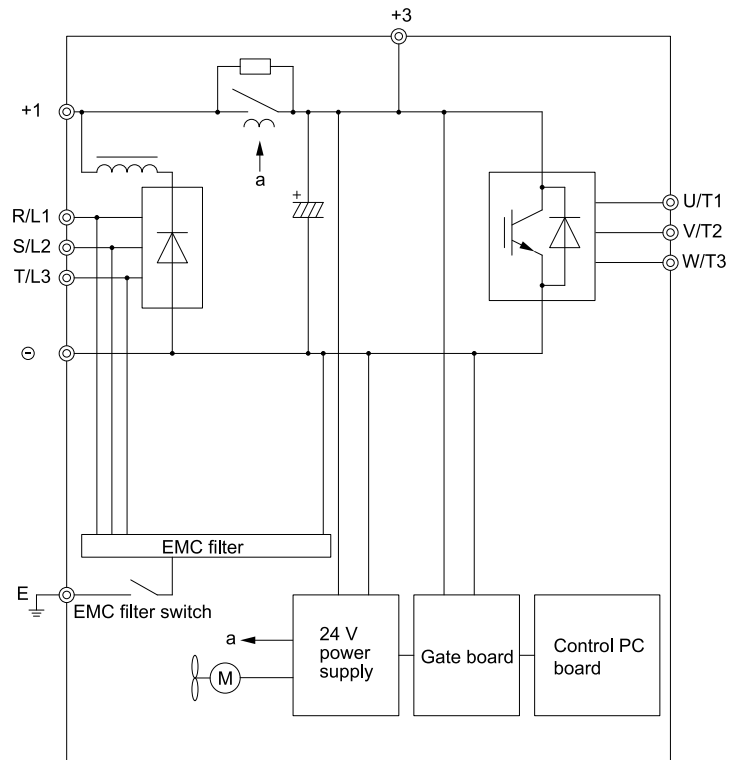

Figure 3.22 Drive Main Circuit Configuration 3

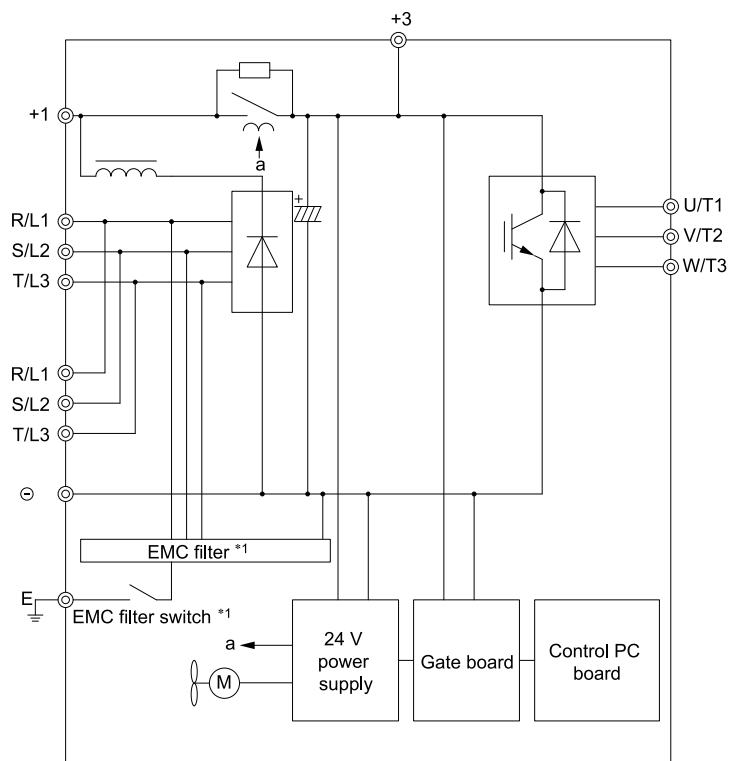

Figure 3.23 Drive Main Circuit Configuration 4

*1 Drive models 4810 to 4H12 do not have EMC filter switches or EMC filters.

◆ Protection of Main Circuit Terminals

- Insulation Cap
When you wire the main circuit terminals, do not let cable ends go near terminals or the drive. If you use crimped terminals, make sure that you also use insulation caps.
- Insulation Barrier

Insulation barriers are packaged with drive models 4810 to 4H12 for additional protection between terminals. Use insulation barriers to make the wiring more reliable. Refer to [Figure 3.24](#) for information about the insulation barrier installation procedure.

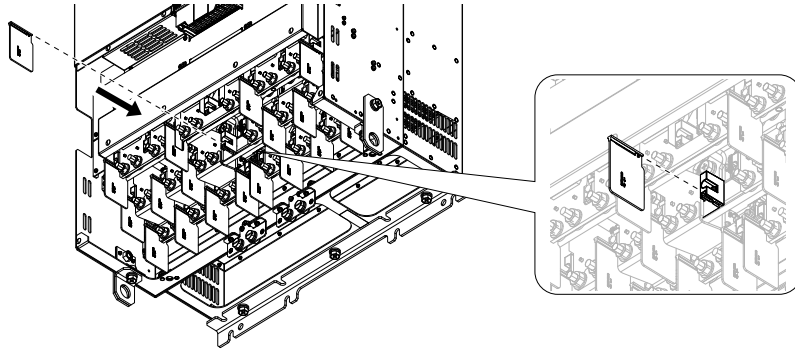

Figure 3.24 Install the Insulation Barriers

◆ 6-Phase/12-Pulse Drives

■ Installing the Transformer

Install a 6-Phase/12-Pulse isolation transformer with output windings phase-shifted by 30 electrical degrees or install a Hybrid 6-Phase topology on the power supply.

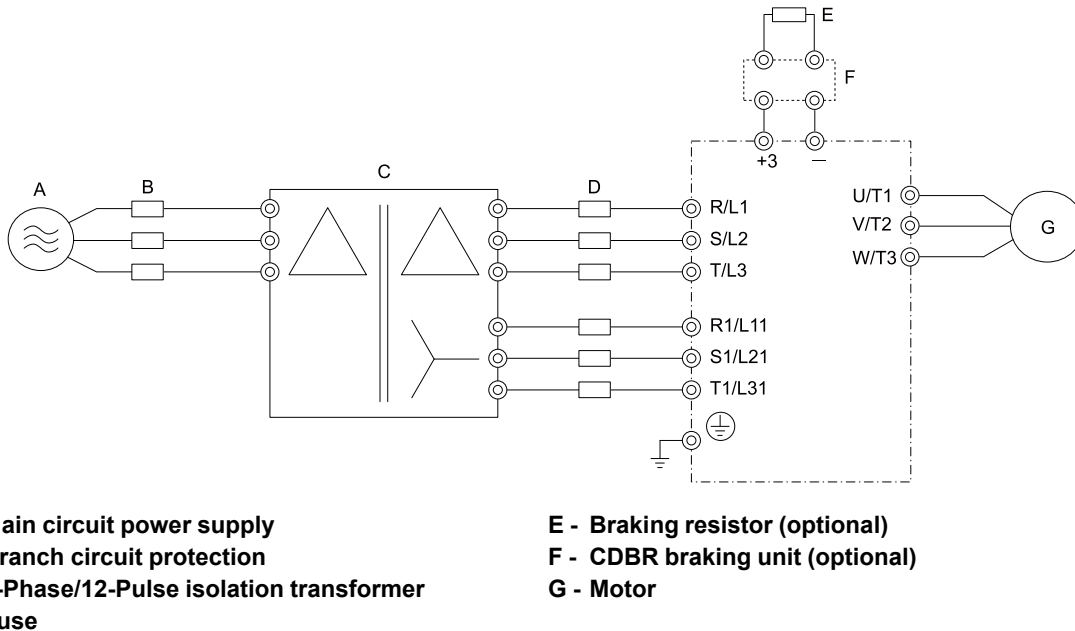
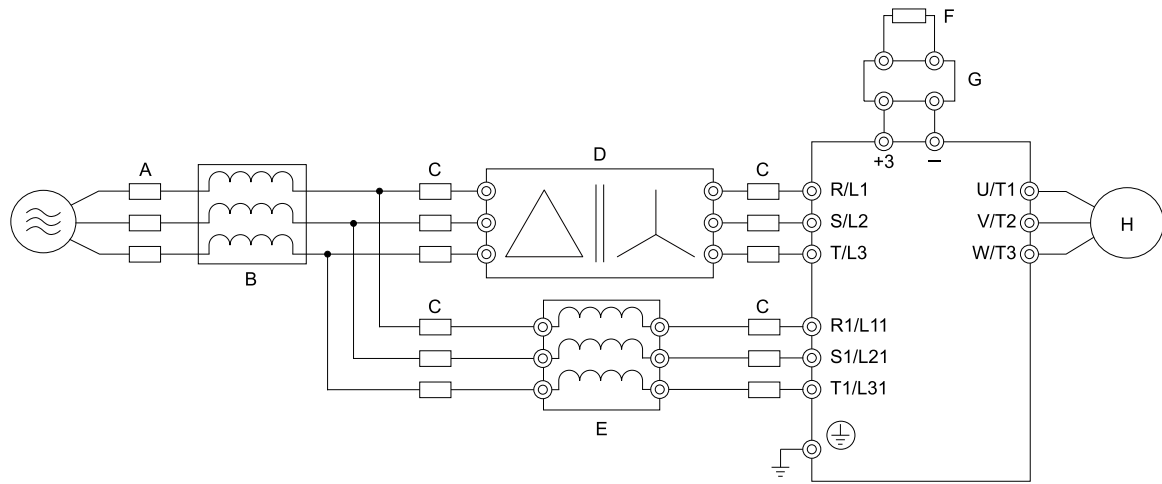

Figure 3.25 Standard 12-Pulse Input Main Circuit Terminal Connections

- *1 Refer to local codes for correct branch circuit protection (BCP) on the primary side of the 6-Phase/12-Pulse transformer.
- *2 Refer to [6-Phase/12-Pulse 400 V Class on page 140](#) for fuses for the secondary side of the 6-Phase/12-Pulse transformer.



A - Branch circuit protection
B - Input reactor (optional)
C - Fuse
D - Delta to Wye transformer

E - Balancing reactor
F - Braking resistor (optional)
G - CDBR braking unit (optional)
H - Motor

Figure 3.26 Main Circuit Terminal Connections, Standard Hybrid 12-Pulse System

3.4 Main Circuit Terminal Block Wiring Procedure

DANGER! Electrical Shock Hazard. Do not examine, connect, or disconnect wiring on an energized drive. Before servicing, disconnect all power to the equipment and wait for the time specified on the warning label at a minimum. The internal capacitor stays charged after the drive is de-energized. The charge indicator LED extinguishes when the DC bus voltage decreases below 50 Vdc. When all indicators are OFF, remove the covers before measuring for dangerous voltages to make sure that the drive is safe. If you do work on the drive when it is energized, it will cause serious injury or death from electrical shock.

The procedures to wire the main circuit terminal block are different for different drive models. Refer to [Table 3.4](#) for procedures by drive model.

Table 3.4 Wiring Procedures for the Main Circuit Terminal Block

Model	Procedure	Ref.
2004 - 2211 4002 - 4168	Procedure A	96
2257 - 2415 4208 - 4720	Procedure B	99
4810 - 4H12	Three-Phase Drives	101
	6-Phase/12-Pulse Drives	102

◆ Wire the Main Circuit Terminal Block with Procedure A

■ Notes on Wiring the Main Circuit Terminal Block

Read these notes before you wire the main circuit terminal block.

- Use UL-Listed, vinyl-coated insulated copper wires for operation with a continuous maximum permitted temperature of 75 °C at 600 V.
- Remove all unwanted objects that are near the terminal block connections.
- Remove the insulation from the connection wires to the wire stripping lengths shown in the manual.
- Do not use bent or crushed wires. Remove the damaged end of the wire before you use it. Incorrect connections can cause death or serious injury from fire.
- Do not solder stranded wire. Soldered wire connections can become loose over time and cause unsatisfactory drive performance.
- If you use stranded wire, make sure that all of the wire strands are in the connection. Also, do not twist the stranded wire too much. Incorrect connections can cause death or serious injury from fire.
- Put the wire all the way into the terminal block. Remove the insulation from the wire to the recommended wire stripping length to fit the wire with insulation in the plastic housing.
- Use a torque driver, torque ratchet, or torque wrench for the screws. A slotted driver or a hex tool will be necessary to wire the screw clamp terminal. Use applicable tools as specified by the recommended conditions in the product manual.
- If you use power tools to tighten the terminal screws, use a low speed setting (300 to 400 r/min). Failure to obey can cause damage to the terminal screws.
- Wire gauges on existing drive models to be replaced may not match wire gauge ranges on new drives. Refer to the drive manuals for correct wire sizes.
- Do not tighten the terminal screws at an angle of 5 degrees or more. Failure to obey can cause damage to the terminal screws.
- If you damage a terminal screw, contact Yaskawa or your nearest sales representative.

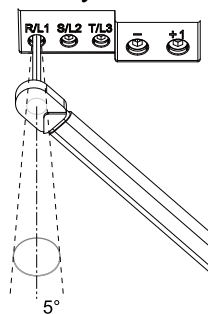

Figure 3.27 Permitted Angle

- Put the bit all the way into the hex socket to tighten the hex socket cap screw.

- When you tighten slotted screws, hold the straight-edge screwdriver perpendicularly to the screw. Make sure that you align the end of the straight-edge screwdriver with the screw groove.

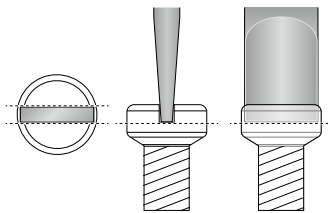
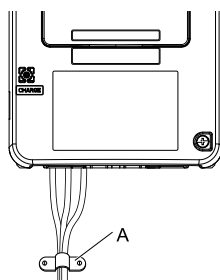

Figure 3.28 Tightening Slotted Screws

- After you connect the wires to the terminal block, lightly pull on the wires to make sure that they do not come out of the terminals.
- Remove the correct section of the wiring cover to make wiring easier.
- Do not let strain on the wiring cause damage. Use a strain relief near the wiring to release the tension. Refer to [Figure 3.29](#) for an example.



A - Cable clamp

Figure 3.29 Strain Relief Example

Table 3.5 Recommended Wiring Tools

Screw Size	Screw Shape	Adapter	Bit		Torque Driver Model (Tightening Torque)	Torque Wrench
			Model	Manufacturer		
M4	⊖	Bit	SF-BIT-SL 1,0X4,0-70	PHOENIX CONTACT	TSD-M 3NM (1.2 - 3 N·m (10.6 - 26.6 lbf·in))	N/A
M5 ^{*1}	⊖	Bit	SF-BIT-SL 1,2X6,5-70	PHOENIX CONTACT	Wire Gauge ≤ 25 mm ² (AWG 10); TSD-M 3NM (1.2 - 3 N·m (10.6 - 26.6 lbf·in))	Wire Gauge ≤ 25 mm ² (AWG 10); N/A
					Wire Gauge ≥ 30 mm ² (AWG 8): N/A	Wire Gauge ≥ 30 mm ² (AWG 8): 4.1 - 4.5 N·m (36.3 - 39.8 lbf·in) ^{*2}
M6	⊕	Bit	SF-BIT-HEX 5-50	PHOENIX CONTACT	N/A	5 - 9 N·m (44.3 - 79.9 lbf·in) ^{*2}
	⊖	Bit	SF-BIT-SL 1,2X6,5-70	PHOENIX CONTACT	N/A	3 - 3.5 N·m (26.6 - 31.0 lbf·in) ^{*2}
M8	⊕	Bit	SF-BIT-HEX 6-50	PHOENIX CONTACT	N/A	8 - 12 N·m (70.8 - 106.2 lbf·in) ^{*2}
M10	⊕	Bit	SF-BIT-HEX 8-50	PHOENIX CONTACT	N/A	12 - 14 N·m (106.2 - 123.9 lbf·in) ^{*2}

*1 When wiring drive models 2056, 4089, and smaller, select the correct tools for the wire gauge.
 *2 Use 6.35 mm (0.25 in) bit socket holder.
 *3 Use a torque wrench that can apply this torque measurement range.

■ Main Circuit Terminal Block Wiring Procedure

Remove the keypad and front cover before wiring the main circuit terminal block.

3.4 Main Circuit Terminal Block Wiring Procedure

1. Pull the wiring cover away from the drive to remove it.

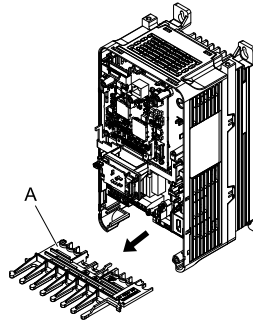

A - Wiring cover

Figure 3.30 Remove the Wiring Cover

2. Put the end of a prepared wire into the terminal block.

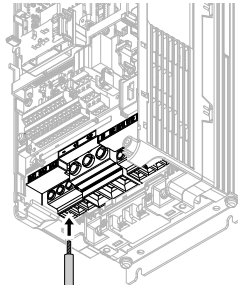

Figure 3.31 Install the Electrical Wire

Note:

If there is a jumper between terminals +1 and +2, loosen the terminal block screws and remove the jumper before wiring the terminals.

3. Tighten the screws to the specified torque.

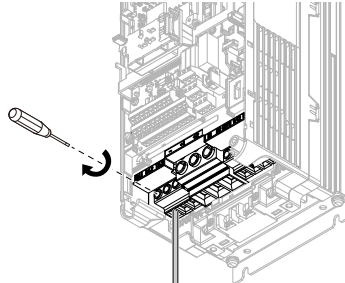
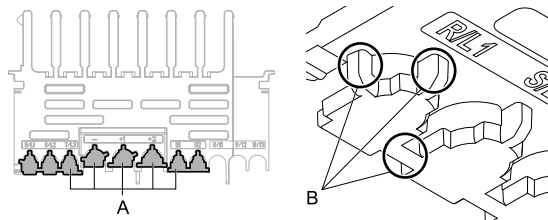

Figure 3.32 Tighten Terminal Block Screws

4. Examine the signal from the wired terminal and use a diagonal-cutting pliers to remove areas of the wiring cover cutaway section.

To remove the wiring cover, cut off the portion shown in [Figure 3.33](#).



A - Cutaway sections

B - Cut this portion with a diagonal-cutting pliers

Figure 3.33 Clip the Cutaway Section of the Wiring Cover

Note:

- Different drive models have different wiring cover shapes.
- Only clip the section of the wiring cover that applies to the wired terminal. If you clip areas that do not apply to wired terminals, the protective enclosure will not keep its IP20 protective level.
- Tightly hold the cutaway section when removing pieces of the cutaway section. Pieces of the cutaway section can fly out and cause injury.
- Make sure that the clipped section does not cause damage to the wires.
- If you use wires that are not specified by Yaskawa, the protective enclosure could lose its IP20 protective level, although the wiring cover is correct. Contact Yaskawa or your nearest sales representative for more information.

5. Put the wiring cover in its initial position. Put the cables through the holes cut from the wiring cover.

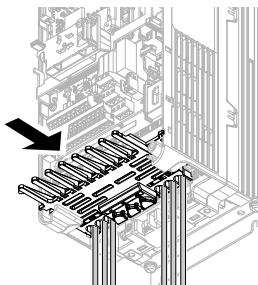

Figure 3.34 Reattach the Wiring Cover

6. Install the front cover and the keypad to their initial positions.

◆ Wire the Main Circuit Terminal Block with Procedure B

■ Notes on Wiring the Main Circuit Terminal Block

Note:

- After the wiring, do not twist or shake the electrical wires too much.
- Be sure to use only wires with the correct size, stripped wire length, and tightening torque as specified by Yaskawa.
- Use tools that fit the shape of the screw head to tighten and loosen the terminal block screws.
- Make sure that there are no loose stranded wires or frayed wires after wiring is complete.

■ Main Circuit Terminal Block Wiring Procedure

Remove the terminal cover before wiring the main circuit terminal block.

1. Remove the screws on the terminal block cover and pull the terminal block cover away from the drive. Pull the wiring cover away from the drive to remove the wiring cover after removing the terminal block cover.

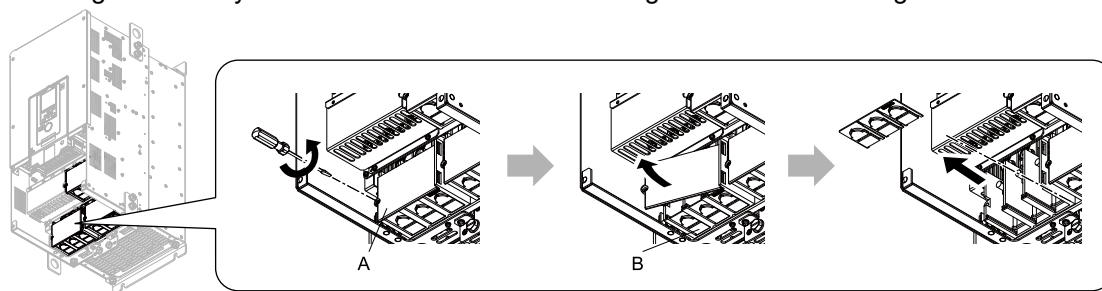

A - Terminal block cover

B - Wiring cover

Figure 3.35 Remove the Wiring Cover

- Remove the terminal block nut.

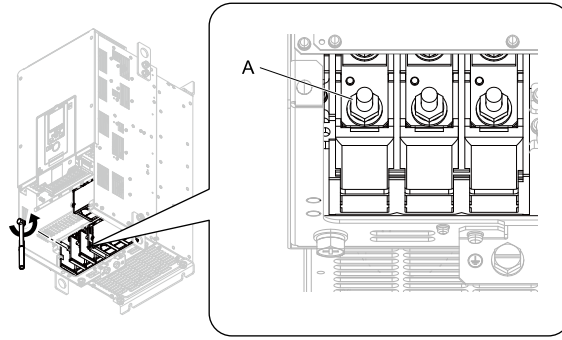

A - Nut

Figure 3.36 Remove the Terminal Block Nut

- Wire the closed-loop crimp terminal to the main circuit terminal block.

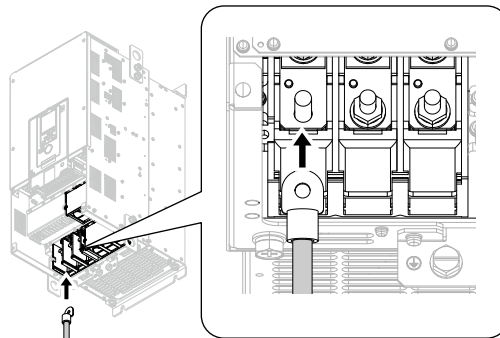

Figure 3.37 Install the Electrical Wire

- Tighten the nut to the specified torque.

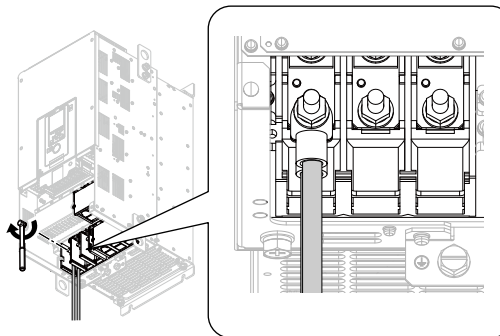
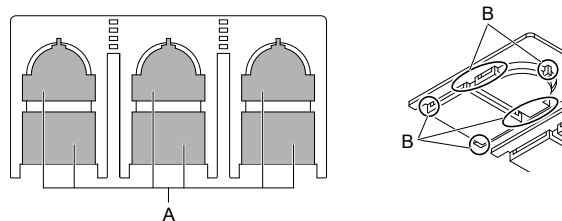

Figure 3.38 Tighten the Terminal Block Nut

- Examine the signal from the wired terminal and use a diagonal-cutting pliers to remove areas of the wiring cover cutaway section.
Cut the areas shown in [Figure 3.39](#).



A - Cutaway sections

B - Use a diagonal-cutting pliers to clip this area.

Figure 3.39 Clip the Cutaway Section of the Wiring Cover

Note:

- Different drive models have different wiring cover shapes.
- Clip only the areas from the wiring cover that apply to the wired terminal. If you clip areas that do not apply to wired terminals, the drive will not keep its IP20 protective level.
- When you clip pieces of the cutaway section, tightly hold the cutaway section. Pieces of the cutaway section can fly out and cause injury.
- Make sure that the clipped section does not cause damage to the wires.
- Although the wiring cover is correct, if you use wires that are not specified by Yaskawa, the drive will not keep its IP20 protective level.
- When you use the recommended gauge for the electrical wires, it is not necessary to attach the wiring cover of the main circuit power input terminal and the drive output terminal. When you use the applicable gauge for the electrical wires, attach the wiring cover.

6. Attach the wiring cover and terminal block cover to their initial positions and tighten the screws on the terminal block cover.

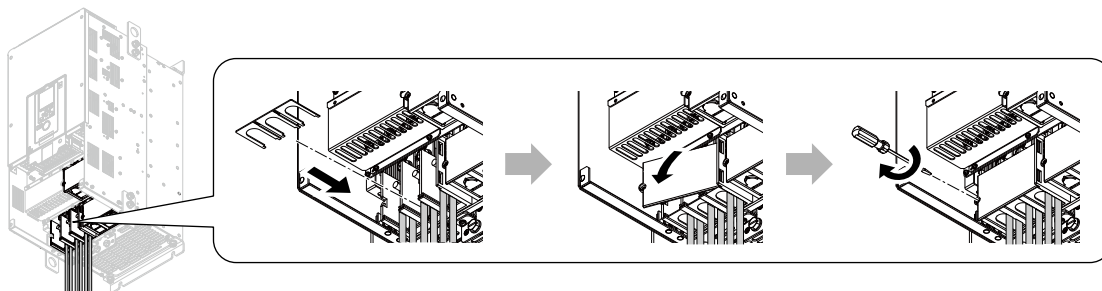

Figure 3.40 Reattach the Wiring Cover

7. Put the terminal cover back in its initial position.

◆ Wire the Main Circuit Terminal Block with Procedure C

■ Notes on Wiring the Main Circuit Terminal Block

Note:

- After the wiring, do not twist or shake the electrical wires too much.
- Be sure to use only wires with the correct size, stripped wire length, and tightening torque as specified by Yaskawa.
- Use tools that fit the shape of the screw head to tighten and loosen the terminal block screws.
- Make sure that there are no loose stranded wires or frayed wires after wiring is complete.

■ Main Circuit Terminal Block Wiring Procedure

Remove the terminal cover before wiring the main circuit terminal block.

1. Remove the terminal block nut.

Note:

When you connect the drive to a three-phase power supply, do not remove the common bus bars.
When you remove the nuts, make sure that the common bus bars do not fall.

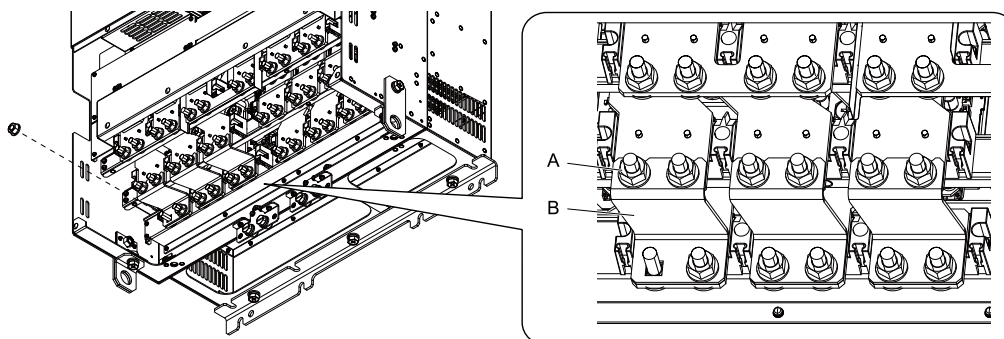

A - Nut

B - Common bus bar

Figure 3.41 Remove the Terminal Block Nut

2. Wire the closed-loop crimp terminal to the main circuit terminal block.

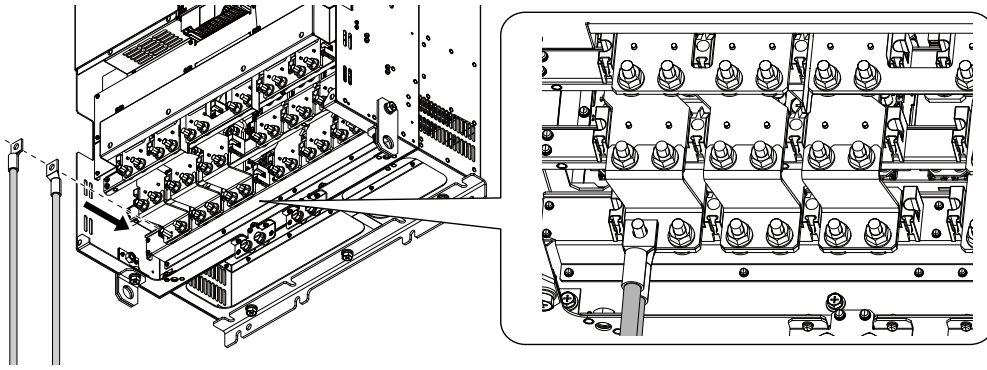

Figure 3.42 Install the Electrical Wire

3. Tighten the nut to the specified torque.

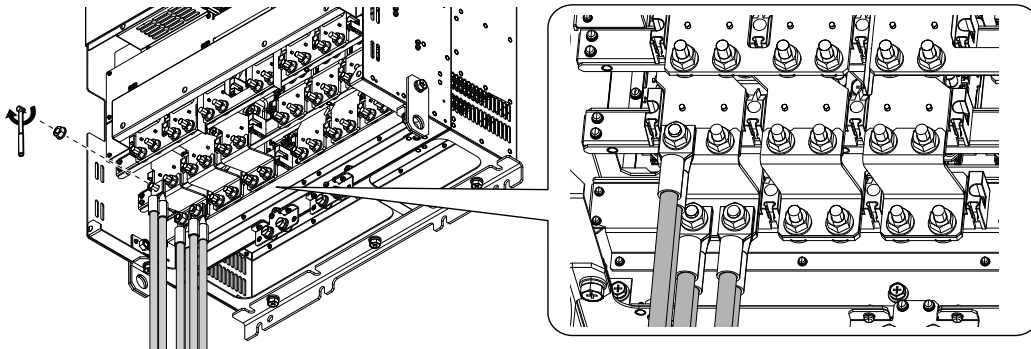

Figure 3.43 Tighten the Terminal Block Nut

4. Install the insulation barriers included in the package between the main circuit terminals.

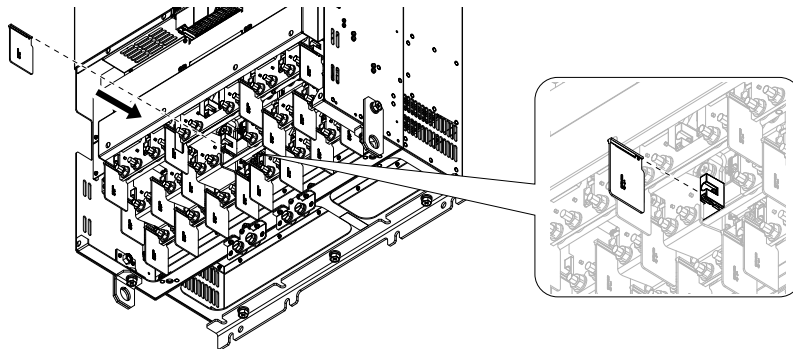

Figure 3.44 Install the Insulation Barriers

5. Put the terminal cover back in its initial position.

◆ Wire the Main Circuit Terminal Block with Procedure D

■ Notes on Wiring the Main Circuit Terminal Block

Note:

- After the wiring, do not twist or shake the electrical wires too much.
- Be sure to use only wires with the correct size, stripped wire length, and tightening torque as specified by Yaskawa.
- Use tools that fit the shape of the screw head to tighten and loosen the terminal block screws.
- Make sure that there are no loose stranded wires or frayed wires after wiring is complete.

■ Main Circuit Terminal Block Wiring Procedure

Remove the terminal cover before wiring the main circuit terminal block.

1. Remove the nuts on terminals R/L1, S/L2, and T/L3, and remove the common bus bars.

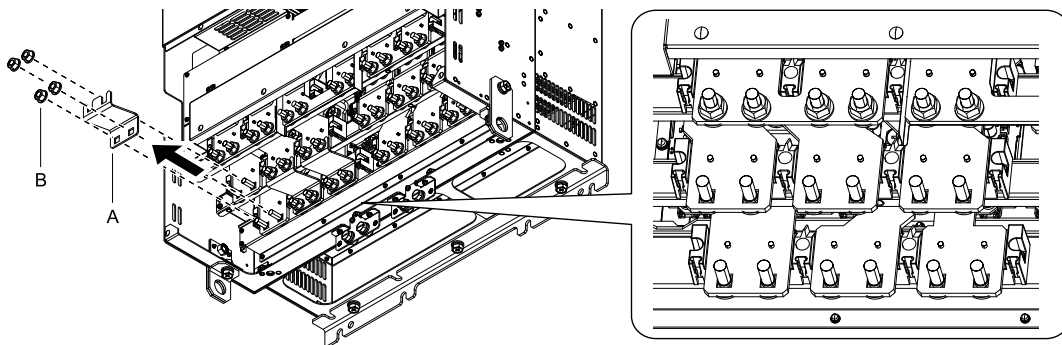

A - Common bus bar

B - Nut

Figure 3.45 Remove Common Bus Bars

2. Wire the closed-loop crimp terminal to the main circuit terminal block.

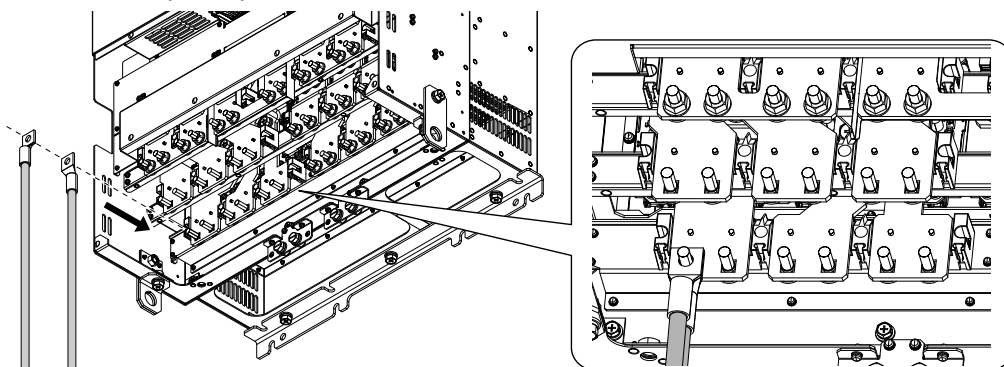

Figure 3.46 Install the Electrical Wires

3. Tighten the nuts to the specified torque.

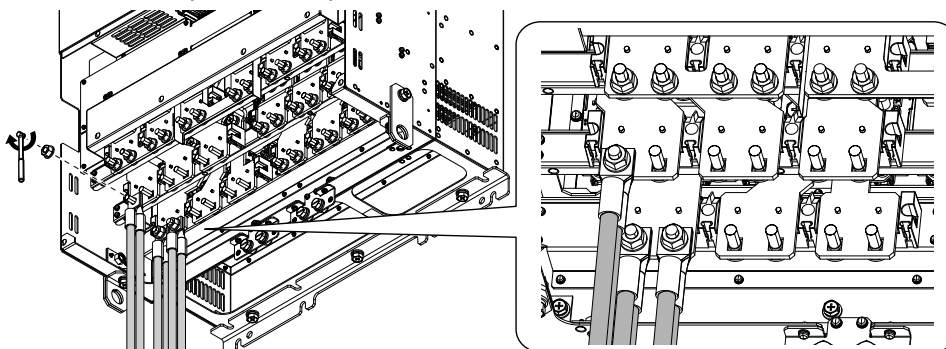

Figure 3.47 Tighten the Terminal Block Nut

4. Install the insulation barriers included in the package between the main circuit terminals.

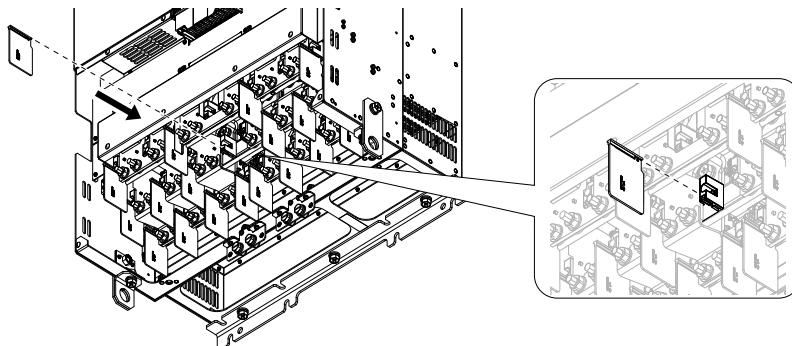

Figure 3.48 Install the Insulation Barriers

5. Put the terminal cover back in its initial position.

3.5 Control Circuit Wiring

This section gives information about how to correctly wire the control circuit.

◆ Control Circuit Connection Diagram

Wire the drive control circuit as shown in Figure 3.49.

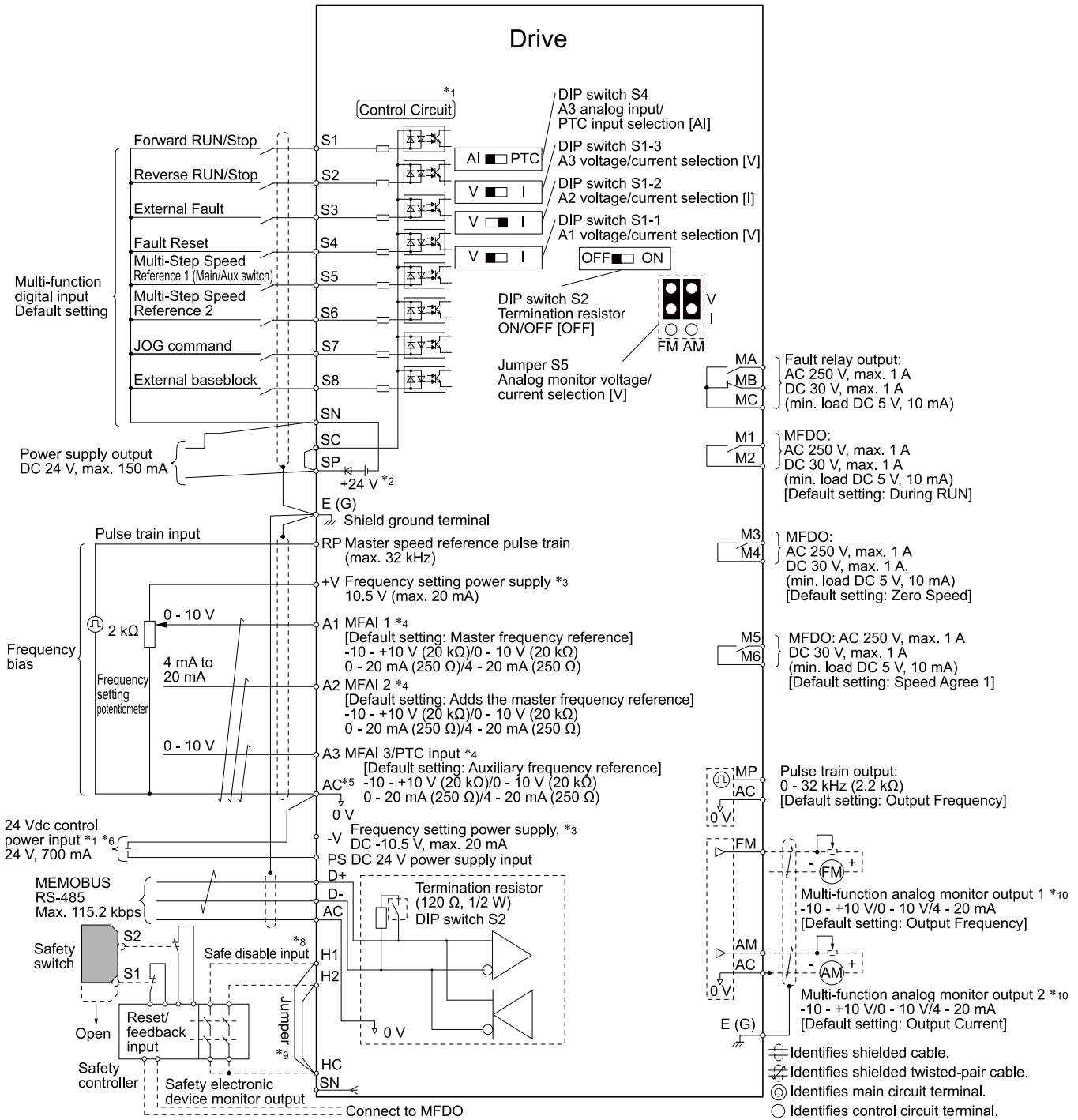

*1 Connect a 24 V Control power input supply to terminals PS-AC to operate the control circuit while the main circuit power supply is OFF.

- *2 To set the MFDI power supply (Sinking/Sourcing Mode or internal/external power supply), install or remove a jumper between terminals SC-SP or SC-SN depending on the application.
- NOTICE: Damage to Equipment.** Do not close the circuit between terminals SP-SN. If you close the circuits between terminals SC-SP and terminals SC-SN at the same time, it will cause damage to the drive.
- Sinking Mode, Internal power supply: Install the jumper to close the circuit between terminals SC-SP.
NOTICE: Damage to Equipment. Do not close the circuit between terminals SC-SN. If you close the circuits between terminals SC-SP and terminals SC-SN at the same time, it will cause damage to the drive.
 - Sourcing Mode, Internal power supply: Install the jumper to close the circuit between terminals SC-SN.
NOTICE: Damage to Equipment. Do not close the circuit between terminals SC-SP. If you close the circuits between terminals SC-SP and terminals SC-SN at the same time, it will cause damage to the drive.
 - External power supply: Remove the jumper from the MFDI terminals. It is not necessary to close the circuit between terminals SC-SP and terminals SC-SN.
- *3 The output current capacity of the +V and -V terminals on the control circuit is 20 mA.
- NOTICE: Do not install a jumper between terminals +V, -V, and AC.** A closed circuit between these terminals will cause damage to the drive.
- *4 Set DIP switches S1-1 to S1-3 to select between a voltage or current input signal to terminals A1 to A3. The default setting for S1-1 and S1-3 is voltage input ("V" side). The default setting for S1-2 is current input ("I" side).
- *5 Do not ground the control circuit terminals AC or connect them to the drive chassis.
- NOTICE: Do not ground the AC control circuit terminals and only connect the AC terminals according to the product instructions.** If you connect the AC terminals incorrectly, it can cause damage to the drive.
- *6 Do not connect terminals PS and AC inversely. If you connect the wires to the incorrect terminals, it will cause damage to the drive.
- *7 Set DIP switch S2 to the ON position to enable the termination resistor in the last drive when you use MEMOBUS/Modbus communications.
- *8 To use the internal power supply with the Safe Disable input, use sourcing mode.
- *9 Disconnect the wire jumpers between H1 and HC and H2 and HC to use the Safe Disable input.
- *10 Use multi-function analog monitor outputs with analog frequency meters, ammeters, voltmeters, and wattmeters. Do not use monitor outputs with feedback-type signal devices.

◆ Control Circuit Terminal Block Functions

Hx-xx parameters set functions for the multi-function input and output terminals.

WARNING! Sudden Movement Hazard. Correctly wire and test all control circuits to make sure that the control circuits operate correctly. If you use a drive that has incorrect control circuit wiring or operation, it can cause death or serious injury.

WARNING! Sudden Movement Hazard. Check the I/O signals and the external sequences for the drive before you set the Application Preset function. When you set the Application Preset function (A1-06 ≠ 0), it changes the I/O terminal functions for the drive and it can cause equipment to operate unusually. This can cause serious injury or death.

NOTICE: Damage to Equipment. Do not energize and de-energize the drive more frequently than one time each 30 minutes. If you frequently energize and de-energize the drive, it can cause drive failure.

■ Input Terminals

Refer to [Table 3.6](#) for a list of input terminals and functions.

Table 3.6 Multi-function Input Terminals

Type	Terminal	Name (Default)	Function (Signal Level)	
Digital Inputs	S1	MFDI selection 1 (ON: Forward run OFF: Stop)	<ul style="list-style-type: none"> • Photocoupler • 24 V, 6 mA <p>Note: Install the wire jumpers between terminals SC-SP and SC-SN to set the MFDI power supply (sinking/sourcing mode or internal/external power supply). • Sinking Mode: Install a jumper between terminals SC and SP.</p> <p>NOTICE: Damage to Equipment. Do not close the circuit between terminals SC-SN. If you close the circuits between terminals SC-SP and terminals SC-SN at the same time, it will cause damage to the drive.</p> <ul style="list-style-type: none"> • Sourcing Mode: Install a jumper between terminals SC and SN. <p>NOTICE: Damage to Equipment. Do not close the circuit between terminals SC-SP. If you close the circuits between terminals SC-SP and terminals SC-SN at the same time, it will cause damage to the drive.</p> <ul style="list-style-type: none"> • External power supply: No jumper necessary between terminals SC-SN and terminals SC-SP. 	
	S2	MFDI selection 2 (ON: Reverse run OFF: Stop)		
	S3	MFDI selection 3 (External fault (N.O.))		
	S4	MFDI selection 4 (Fault reset)		
	S5	MFDI selection 5 (Multi-step speed reference 1)		
	S6	MFDI selection 6 (Multi-step speed reference 2)		
	S7	MFDI selection 7 (Jog command)		
	S8	MFDI selection 8 (Baseblock command (N.O.))		
	SN	MFDI power supply 0 V		MFDI power supply, 24 V (maximum 150 mA)
	SC	MFDI selection common		<p>NOTICE: Damage to Equipment. Do not close the circuit between terminals SP-SN. If you close the circuits between terminals SC-SP and terminals SC-SN at the same time, it will cause damage to the drive.</p>
SP	MFDI power supply +24 Vdc			
Safe Disable Input	H1	Safe Disable input 1	<p>Remove the jumper between terminals H1-HC and H2-HC to use the Safe Disable input.</p> <ul style="list-style-type: none"> • 24 V, 6 mA • ON: Normal operation • OFF: Coasting motor • Internal impedance 4.7 kΩ • OFF Minimum OFF time of 2 ms. <p>Safe Disable function common</p> <p>NOTICE: Do not close the circuit between terminals HC and SN. A closed circuit between these terminals will cause damage to the drive.</p>	
	H2	Safe Disable input 2		
	HC	Safe Disable function common		
Master Frequency Reference	RP	Master frequency reference pulse train input (Master frequency reference)	<ul style="list-style-type: none"> • Response frequency: 0 Hz to 32 kHz • H level duty: 30% to 70% • H level voltage: 3.5 V to 13.2 V • L level voltage: 0.0 V to 0.8 V • Input impedance: 3 kΩ 	
	+V	Power supply for frequency setting	10.5 V (allowable current 20 mA maximum)	
	-V	Power supply for frequency setting	-10.5 V (allowable current 20 mA maximum)	
	A1	MFAI1 (Master frequency reference)	<p>Voltage input or current input</p> <p>Select terminal A1 with DIP switch S1-1 and H3-01 [Terminal A1 Signal Level Select].</p> <p>Select terminal A2 with DIP switch S1-2 and H3-09 [Terminal A2 Signal Level Select]</p> <ul style="list-style-type: none"> • -10 V to +10 V/-100% to +100% (input impedance: 20 kΩ) • 0 V to 10 V/100% (input impedance: 20 kΩ) • 4 mA to 20 mA/100%, 0 mA to 20 mA/100% (input impedance: 250 Ω) 	
	A2	MFAI2 (Combined to terminal A1)		
	A3	MFAI3/PTC input (Auxiliary frequency reference)	<ul style="list-style-type: none"> • Voltage input or current input Select using DIP switch S1-3 and H3-05 [Terminal A3 Signal Level Select]. - -10 V to +10 V/-100% to +100% (input impedance: 20 kΩ) - 0 V to 10 V/100% (input impedance: 20 kΩ) - 4 mA to 20 mA/100%, 0 mA to 20 mA/100% (input impedance: 250 Ω) • PTC input (Motor Overheat Protection) Set DIP switch S4 to "PTC" and set DIP switch S1-3 to "V" to set terminal A3 for PTC input. 	
	AC	Frequency reference common	0 V	
	E (G)	Connecting shielded cable	-	

■ Output Terminals

Refer to [Table 3.7](#) and [Table 3.8](#) for a list of Output terminals and functions.

Table 3.7 Control Circuit Output Terminals

Type	Terminal	Name (Default)	Function (Signal Level)
Fault Relay Output	MA	N.O. output (Fault)	<ul style="list-style-type: none"> Relay output 30 Vdc, 10 mA to 1 A 250 Vac, 10 mA to 1 A Minimum load: 5 V, 10 mA (Reference value)
	MB	N.C. output (Fault)	
	MC	Digital output common	
MFDO	M1	MFDO (During Run)	<ul style="list-style-type: none"> Relay output 30 Vdc, 10 mA to 1 A 250 Vac, 10 mA to 1 A Minimum load: 5 V, 10 mA (Reference value) <p>Note: Do not set functions that frequently switch ON/OFF to MFDO (M1 to M6) because this will decrease the performance life of the relay contacts. Yaskawa estimates switching life at 200,000 times (assumes 1 A, resistive load).</p>
	M2		
	M3	MFDO (Zero Speed)	
	M4		
	M5	MFDO (Speed Agree 1)	
	M6		

Table 3.8 Control Circuit Monitor Output Terminals

Type	Terminal	Name (Default)	Function (Signal Level)
Monitor Output	MP	Pulse train output (Output frequency)	32 kHz (maximum) Refer to "Pulse Train Output" (page 115) for more information.
	FM	Analog monitor output 1 (Output frequency)	Select voltage or current output. <ul style="list-style-type: none"> 0 V to 10 V/0% to 100% -10 V to +10 V/-100% to +100% 4 mA to 20 mA (Receiver recommended impedance: 250 Ω) <p>Note: Select with jumper switch S5 and H4-07 [Terminal FM Signal Level Select] or H4-08 [Terminal AM Signal Level Select].</p>
	AM	Analog monitor output 2 (Output current)	
	AC	Monitor common	0 V

External Power Supply Input Terminals

Refer to Table 3.9 for a list of the functions of the external power supply input terminals.

Table 3.9 External Power Supply Input Terminals

Type	Terminal	Name (Default)	Function
External Power Supply Input Terminals	PS	External 24 V power supply input	Supplies backup power to the drive control circuit, keypad, and option board. 21.6 VDC to 26.4 VDC, 700 mA
	AC	External 24 V power supply ground	0 V

Alarm Display When You Use External 24 V Power Supply

When you use an external 24 V power supply, the drive detects an alarm as shown in Table 3.10 if you set o2-23 [External 24V Powerloss Detection] and o2-26 [Alarm Display at Ext. 24V Power] for the main circuit power supply. Set the alarm display as necessary.

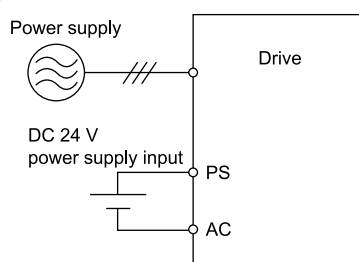

Table 3.10 Power Supply and Alarm Display

Main Circuit Power Supply	External 24 V Power Supply	o2-23 [External 24V Powerloss Detection]	o2-26 [Alarm Display at Ext. 24V Power]	Alarm Display
ON	ON	-	-	-
ON	OFF	0 [Disabled]	-	-
		1 [Enabled]	-	L24v [Loss of External Power 24 Supply]

3.5 Control Circuit Wiring

Main Circuit Power Supply	External 24 V Power Supply	o2-23 [External 24V Powerloss Detection]	o2-26 [Alarm Display at Ext. 24V Power]	Alarm Display
OFF	ON	-	0 [Disabled]	"Ready" LED light flashes quickly
		-	1 [Enabled]	EP24v [External Power 24V Supply]

Operation When Using External 24 V Power Supply

To operate the drive, de-energize the main circuit power supply and connect an external 24 V power supply to terminals PS-AC.

Function	Operation	Solution
Keypad	The keypad operates the same as when the main circuit power supply is ON. The drive will not detect <i>oPr</i> [Keypad Connection Fault].	-
Data Log	The data log function operates the same as when the main circuit power supply is ON. The operation is different for different drive software versions. *1	-
Communications by Communication Option or MEMOBUS/Modbus Communication Terminals	Communication operates the same as when the main circuit power supply is ON.	-
MFAI	MFAI operates the same as when the main circuit power supply is ON.	-
MFAO	MFAO operates the same as when the main circuit power supply is ON.	-
MFDI	MFDI does not operate when the main circuit power supply of the drive is OFF.	Connect the external 24 V power supply to the MFDI selection common terminal (SC). *2
MFDO Multi-Function Photocoupler Output Fault Relay Output Terminal	MFDO operates the same as when the main circuit power supply is ON. The operations of MFDO terminals and fault relay output terminals set for $H2-xx = E$ [Fault] are different for different drive software versions. *3	-
Pulse Train Input	Pulse train input operates the same as when the main circuit power supply is ON.	-
Pulse train output	Pulse train output operates the same as when the main circuit power supply is ON.	-
Encoder Option Speed Detection (PG-B3, PG-X3, PG-F3, PG-RT3)	Encoder options do not operate when the main circuit power supply of the drive is OFF. The operation to detect encoder option-related faults is different for different software versions.	When you use an encoder, make sure that the drive main circuit power supply is ON. *4
Analog Input Option (AI-A3)	Analog input options operate the same as when the main circuit power supply is ON.	-
Analog Output Option (AO-A3)	Analog output options operate the same as when the main circuit power supply is ON. The operation is different for different drive software versions. *5	-
Digital Input Option (DI-A3)	Digital input options do not operate when the main circuit power supply of the drive is OFF.	Connect the external 24 V power supply to the Input signal common terminal (SC). *2
Digital Output Option (DO-A3)	Digital output options operate the same as when the main circuit power supply is ON.	-

*1 When you use an external 24 V power supply, the operation of the data log function is different for different drive software versions. On drives with software versions PRG: 09015 and later, you can continue the data log function.

Note:

The "PRG" column on the nameplate on the right side of the drive identifies the software version. You can also use *U1-25* [SoftwareNumber FLASH] to identify the software version.

*2 When you use MFDI and a Digital Input option (DI-A3), wire the terminals as shown in [Wiring MFDI Terminals on page 109](#) or [Wiring Digital Input Option \(DI-A3\) on page 109](#).

*3 When you use an external 24 V power supply, the operation of the MFDO terminals are different for different drive software versions.

Note:

The "PRG" column on the nameplate on the right side of the drive identifies the software version. You can also use *U1-25* [SoftwareNumber FLASH] to identify the software version.

- Drive software versions PRG: 01028 and later
When the main circuit power supply of the drive turns off, and you remove the cause of a fault and do a fault reset from the keypad, the main circuit power supply terminals and the MFDO terminals set for $H2-xx = E, 10E$ [Fault] will change status.
- Drive software versions PRG: 01027 and earlier
When the main circuit power supply of the drive turns off, remove the cause of a fault and do a fault reset from the keypad. The fault relay output terminals and the MFDO terminals set for $H2-xx = E, 10E$ [Fault] will keep the same status as before the main circuit power supply of the drive turned off. The fault code shown on the keypad will disappear.

- *4 If the motor shaft can rotate while the 24 V control power supply is energized and the main circuit power supply is de-energized, re-energize the 24 V control power supply and energize the main circuit power supply.
- *5 When you use an external 24 V power supply, the operation of the Analog Output option is different for different drive software versions. On drives with software versions PRG:09015 and later, the Analog Output option (AO-A3) can output the analog signals.

Note:

The "PRG" column on the nameplate on the right side of the drive identifies the software version. You can also use *UI-25 [SoftwareNumber FLASH]* to identify the software version.

When you use an external 24 V power supply, if you de-energize the main circuit power supply, the encoder option will not operate, even when you connect the external 24 V power supply to terminals PS-AC. When you use an encoder option, energize the drive main circuit power supply.

Note:

Yaskawa recommends that you use different external power supplies for the external power supply input terminals (PS-AC) and MFDI selection common terminal (SC) / Input signal common terminal (SC).

Wiring MFDI Terminals

If you de-energize the main circuit power supply, the MFDI terminals will not operate, even when you connect the external 24 V power supply to terminals PS-AC. When you set N.O. functions to *H1-xx [MFDI Function Select]*, MFDI terminals always deactivate. When you set N.C. functions, MFDI terminals always activate. Connect the external 24 V power supply to the MFDI selection common terminal (SC).

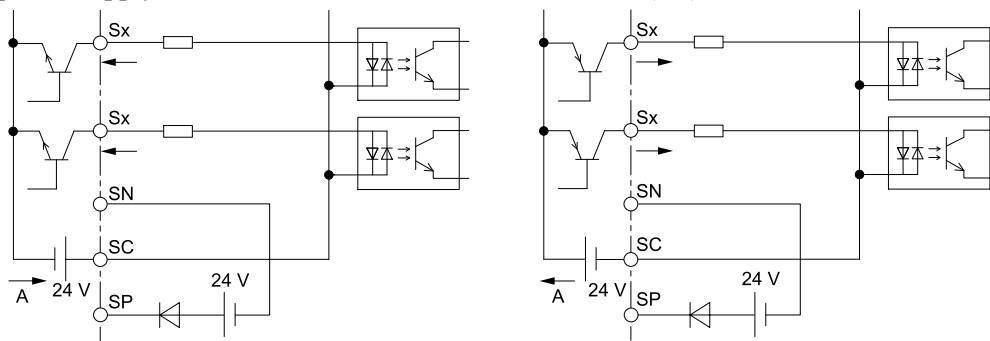

A - External power supply

Figure 3.50 Wiring MFDI Terminals

Wiring Digital Input Option (DI-A3)

If you de-energize the main circuit power supply, the Digital Input Option terminals will not operate, even when you connect the external 24 V power supply to terminals PS-AC. When you set N.O. functions to *F3-xx [Terminal Dx Function Selection]*, the input terminals on the digital input option always deactivate. When you set N.C. functions, the input terminals on the digital input option always activate. Connect the external 24 V power supply to the Input signal common terminal (SC).

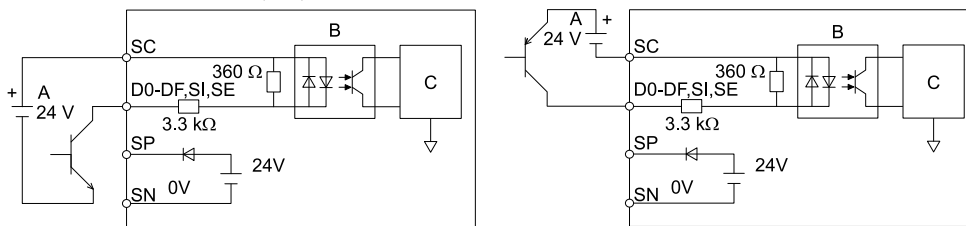

A - External power supply
B - Photocoupler

C - Signal processor

Figure 3.51 Wiring Digital Input Option (DI-A3)

Serial Communication Terminals

Refer to [Table 3.11](#) for a list of serial communication terminals and functions.

Table 3.11 Serial Communication Terminals

Type	Terminal	Terminal Name	Function (Signal Level)	
Modbus Communication	D+	Communication input/output (+)	MEMOBUS/Modbus communications Use an RS-485 cable to connect the drive. Note: Set DIP switch S2 to ON to enable the termination resistor in the last drive in a MEMOBUS/Modbus network.	<ul style="list-style-type: none"> RS-485 MEMOBUS/Modbus communication protocol Maximum 115.2 kbps
	D-	Communication output (-)		
	AC	Shield ground	0 V	

◆ Control Circuit Terminal Configuration

The control circuit terminals are in the positions shown in [Figure 3.52](#).

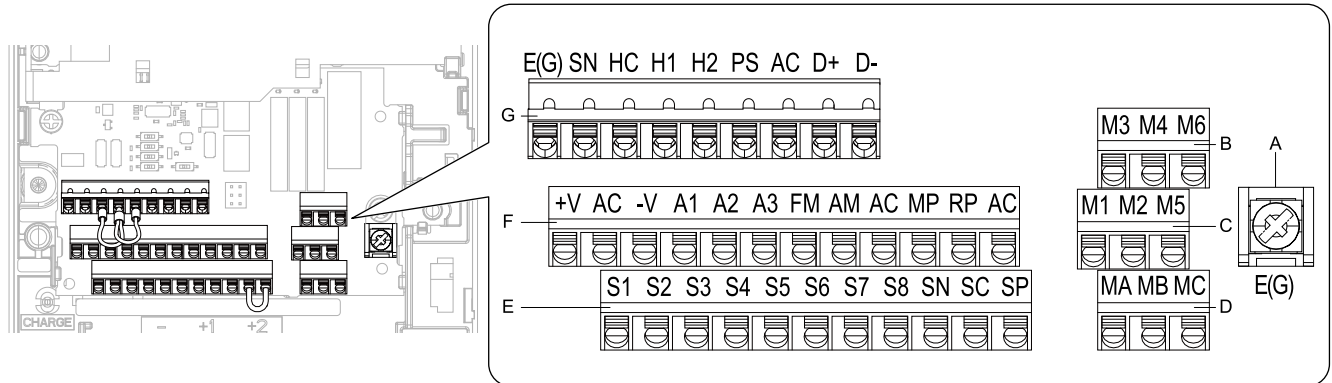

- A - Terminal block (TB5)
- B - Terminal block (TB2-3)
- C - Terminal block (TB2-2)
- D - Terminal block (TB2-1)
- E - Terminal block (TB1)
- F - Terminal block (TB3)
- G - Terminal block (TB4)

Figure 3.52 Control Circuit Terminal Arrangement

■ Control Circuit Wire Gauges and Tightening Torques

Use the tables in this section to select the correct wires. Use shielded wire to wire the control circuit terminal block. Use crimp ferrules on the wire ends to make the wiring procedure easier and more reliable.

Table 3.12 Control Circuit Wire Gauges and Tightening Torques

Terminal Block	Terminal	Screw Size	Tightening Torque N·m (lbf·in)	Bare Wire		Crimp Ferrule	
				Recomm. Gauge mm ² (AWG)	Applicable Gauge mm ² (AWG)	Recomm. Gauge mm ² (AWG)	Applicable Gauge mm ² (AWG)
TB1	S1 - S8, SN, SC, SP	-	-	0.75 (18)	<ul style="list-style-type: none"> Stranded wire 0.2 - 1.0 (24 - 18) Solid wire 0.2 - 1.5 (24 - 16) 	0.5 (20)	0.25 - 0.5 (24 - 20)
TB2	M1 - M6, MA, MB, MC						
TB3	+V, AC, -V, A1, A2, A3, FM, AM, AC, MP, RP, AC						
TB4	E (G), SN, HC, H1, H2, PS, AC, D+, D-	M3.5	0.5 - 1.0 (4.4 - 8.9)	0.5 - 2 (20 - 14)	1.25 (12)	-	-
TB5	E (G)						

Crimp Ferrules

Attach an insulated sleeve when you use crimp ferrules. Refer to [Table 3.13](#) for the recommended external dimensions and model numbers of crimp ferrules.

Use the CRIMPFOX 6, a crimping tool made by PHOENIX CONTACT.

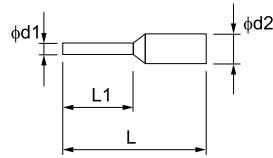

Figure 3.53 External Dimensions of Crimp Ferrules

Table 3.13 Crimp Ferrule Models and Sizes

Wire Gauge mm ² (AWG)	Model	L (mm)	L1 (mm)	φd1 (mm)	φd2 (mm)
0.25 (24)	AI 0.25-8YE	12.5	8	0.8	2.0
0.34 (22)	AI 0.34-8TQ	12.5	8	0.8	2.0
0.5 (20)	AI 0.5-8WH, AI 0.5-8OG	14	8	1.1	2.5

◆ Wiring the Control Circuit Terminal

WARNING! *Electrical Shock Hazard. Do not remove covers or touch circuit boards while the drive is energized. If you touch the internal components of an energized drive, it can cause serious injury or death.*

NOTICE: *Do not let wire shields touch other signal lines or equipment. Insulate the wire shields with electrical tape or shrink tubing. If you do not insulate the wire shields, it can cause a short circuit and damage the drive.*

Note:

- Isolate control circuit wiring from main circuit wiring (terminals R/L1, S/L2, T/L3, R1/L11, S1/L21, T1/L31, B1, B2, U/T1, V/T2, W/T3, -, +1, +2, +3) and other high-power wiring. If control circuit wiring is adjacent to main circuit wiring, it can cause incorrect operation of the drive and equipment from electrical interference.
- Isolate wiring for contact output terminals MA, MB, MC and M1-M6 from other control circuit wiring. If contact output terminal wiring is adjacent to other control circuit wiring, it can cause incorrect operation of the drive and equipment from electrical interference.
- Use a Class 2 power supply to connect external power to the control terminals. If the power supply for peripheral devices is incorrect, it can cause a decrease in drive performance.
- Connect the shield of shielded cable to the applicable ground terminal. Incorrect equipment grounding can cause drive or equipment malfunction from electrical interference.

Correctly ground the drive terminals and complete main circuit wiring before you wire the control circuit.
Remove the keypad and front cover.

1. Push in on the tabs on the both sides of the LED status ring board to release the board from the bracket. Pull the board forward to remove it.

NOTICE: *When you remove the LED Status Board from the drive bracket, make sure that you temporarily install it in the holding position provided on the drive. If you cause damage to the LED status ring board, the LEDs will not function correctly.*

Note:

You can temporarily store the LED status ring board with the temporary placement holes on the drive. The location of the temporary placement holes is different on different drive models.

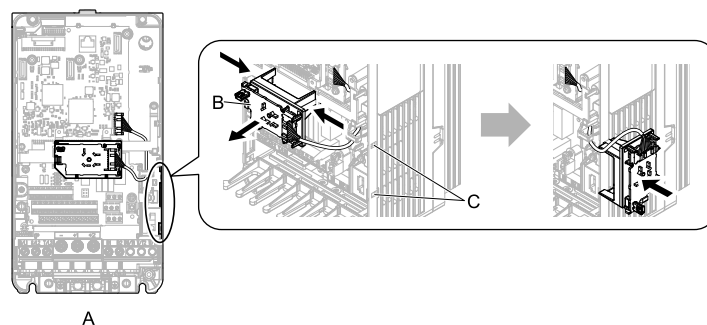

A - Drive front

B - LED status ring board

C - Temporary placement holes

Figure 3.54 Remove the LED Status Ring Board

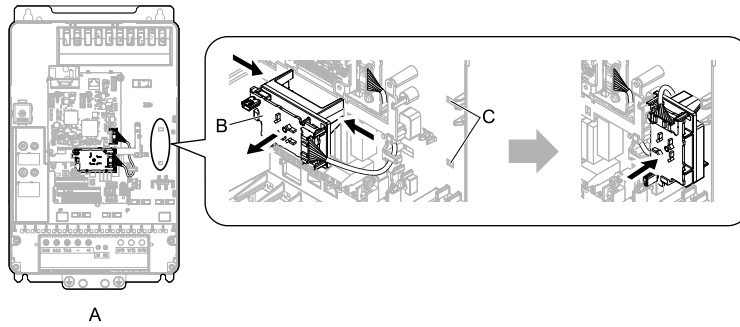

A - Drive front
B - LED status ring board

C - Temporary placement holes

Figure 3.55 Remove the LED Status Ring Board

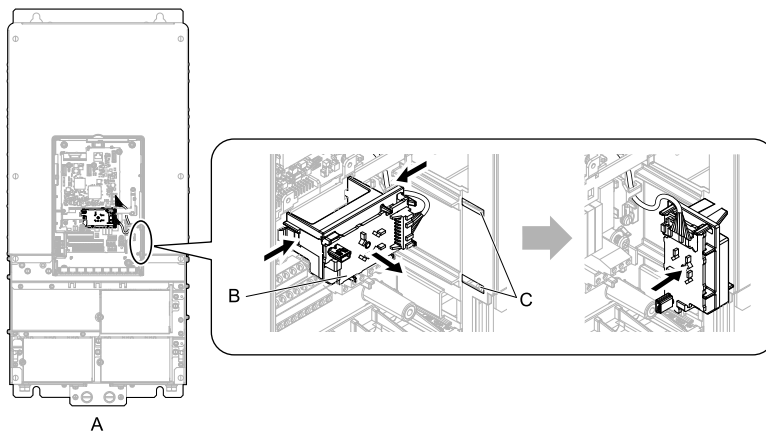

A - Drive front
B - LED status ring board

C - Temporary placement holes

Figure 3.56 Remove the LED Status Ring Board

2. Refer to the figure and wire the control circuit.

WARNING! Fire Hazard. Tighten all terminal screws to the correct tightening torque. Connections that are too loose or too tight can cause incorrect operation and damage to the drive. Incorrect connections can also cause death or serious injury from fire.

Note:

- Use shielded, twisted-pair wires and ground the shield to the ground terminal of the drive. Incorrect equipment grounding can cause drive or equipment malfunction from electrical interference.
- Do not use control circuit wiring that is longer than 50 m (164 ft) to supply the analog frequency reference from a remote source. If the control circuit wiring is too long, it can cause unsatisfactory system performance.

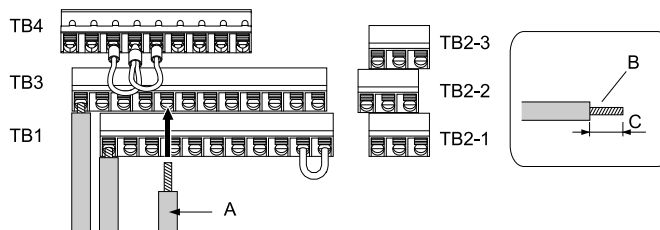

A - Wire with a crimp ferrule attached, or unsoldered wire with the core wires lightly twisted

B - Pull back the shielding and lightly twist the end with your fingers to keep the ends from fraying.

C - When you do not use crimp ferrules, remove approximately 8.5 mm (0.33 in) of the covering at the end of the wire.

Figure 3.57 Wiring Procedure for the Control Circuit

Note:

- Do not solder the core wire. Soldered wiring connections can become loose and cause the drive to malfunction.
- Refer to [Figure 3.58](#) for information to prepare terminal ends of the shielded wire.
- Prepare the wire ends of shielded twisted-pair wires as shown in [Figure 3.58](#) to use an analog reference from an external frequency setting potentiometer to set the frequency. Connect the shield to terminal E (G) of the drive.

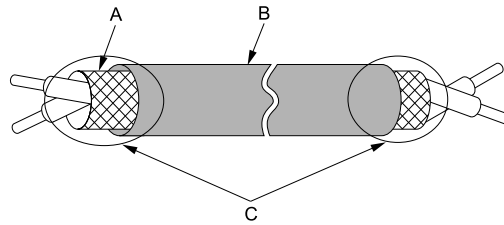

A - Connect the shield to terminal E (G) of the drive. C - Insulate with electrical tape or shrink tubing.
B - Sheath

Figure 3.58 Prepare the Ends of Shielded Wire

3. Put the wires through the clearance in the wiring cover.

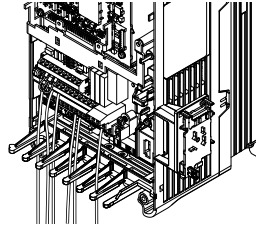

Figure 3.59 Control Circuit Wiring

4. On drive models 4810 to 4H12, wire the drive control circuit as shown in [Figure 3.60](#) or [Figure 3.61](#).

NOTICE: Damage to Equipment. Use tubing or other protection for the wires to prevent damage to the wires at the edges of the opening. If there is damage to the wires, it can cause incorrect operation.

Note:

When you wire the control circuit wiring outside the drive, use the slits on the sides of the drive and safety the wires with cable ties. You can wire on either the left or right side.

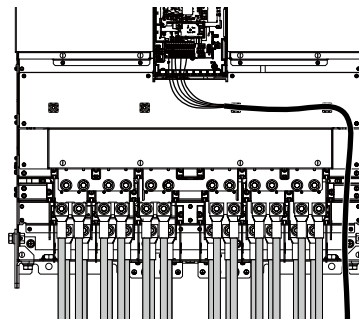
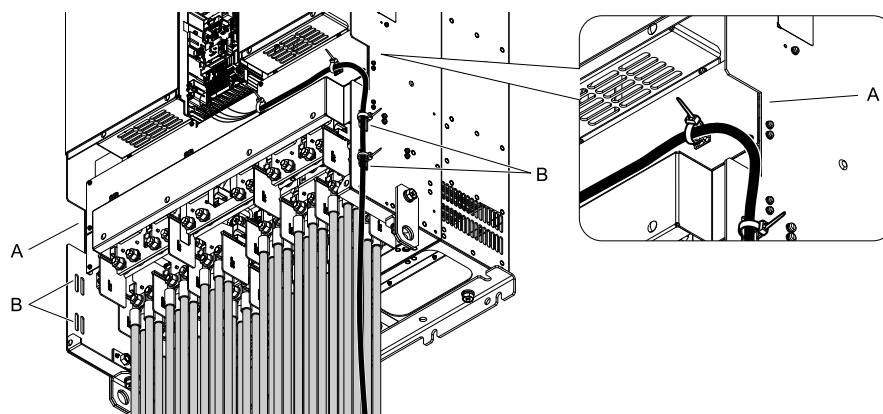

Figure 3.60 Wiring Inside the Drive



A - Opening

B - Slit to Safety Wires

Figure 3.61 Wiring Outside the Drive

5. Install the LED status ring board, front cover, and the keypad to their initial positions.

◆ Switches and Jumpers on the Terminal Board

The terminal board has switches to adapt the drive I/Os to the external control signals as shown in Figure 3.62. Set the switches to select the functions for each terminal.

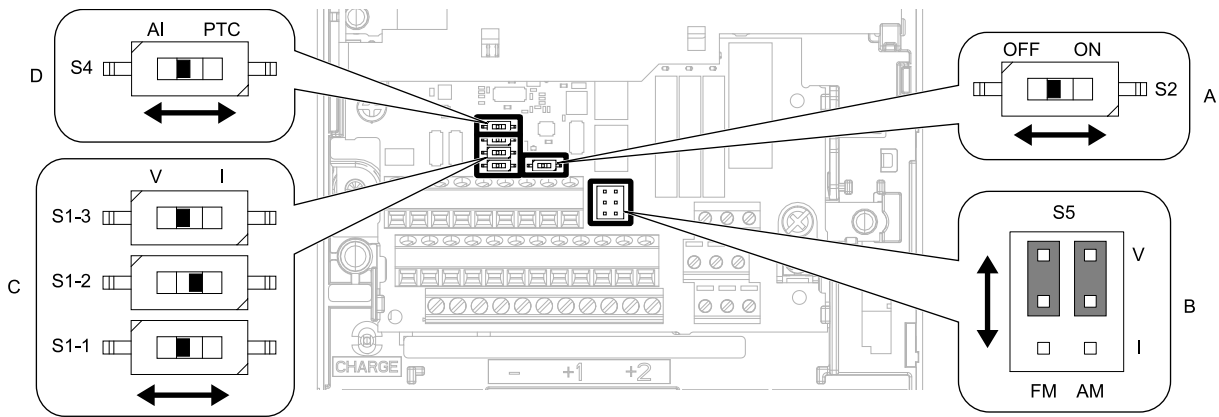

Figure 3.62 Locations of Switches

Table 3.14 I/O Terminals and Switches Functions

Position	Switch	Terminal	Function	Default
A	DIP switch S2	-	Enables and disables the MEMOBUS/Modbus communications termination resistor.	OFF
B	Jumper Switch S5	FM, AM	Sets terminals FM and AM to voltage or current output.	FM: V (voltage output) AM: V (voltage output)
C	DIP switch S1-1	A1	Sets the input signal type (voltage/current).	V (voltage input)
	DIP switch S1-2	A2	Sets the input signal type (voltage/current).	I (current input)
	DIP switch S1-3	A3	Sets the input signal type (voltage/current).	V (voltage input)
D	DIP switch S4	A3	Sets MFAI or PTC input.	AI (analog input)

3.6 Control I/O Connections

This section gives information about the settings for the listed control circuit I/O signals.

- MFDI (terminals S1 to S8)
- Pulse train output (terminal MP)
- MFAI (terminals A1 to A3)
- PTC input (terminal A3)
- MFAO (terminals FM, AM)
- MEMOBUS/Modbus communications (terminals D+, D-, AC)

◆ Set Sinking Mode/Sourcing Mode

Close the circuit between terminals SC-SP and SC-SN to set the sinking mode/sourcing mode and the internal/external power supply for the MFDI terminals. The default setting for the drive is internal power supply sinking mode.

NOTICE: Damage to Equipment. Do not close the circuit between terminals SP-SN. If you close the circuits between terminals SC-SP and terminals SC-SN at the same time, it will cause damage to the drive.

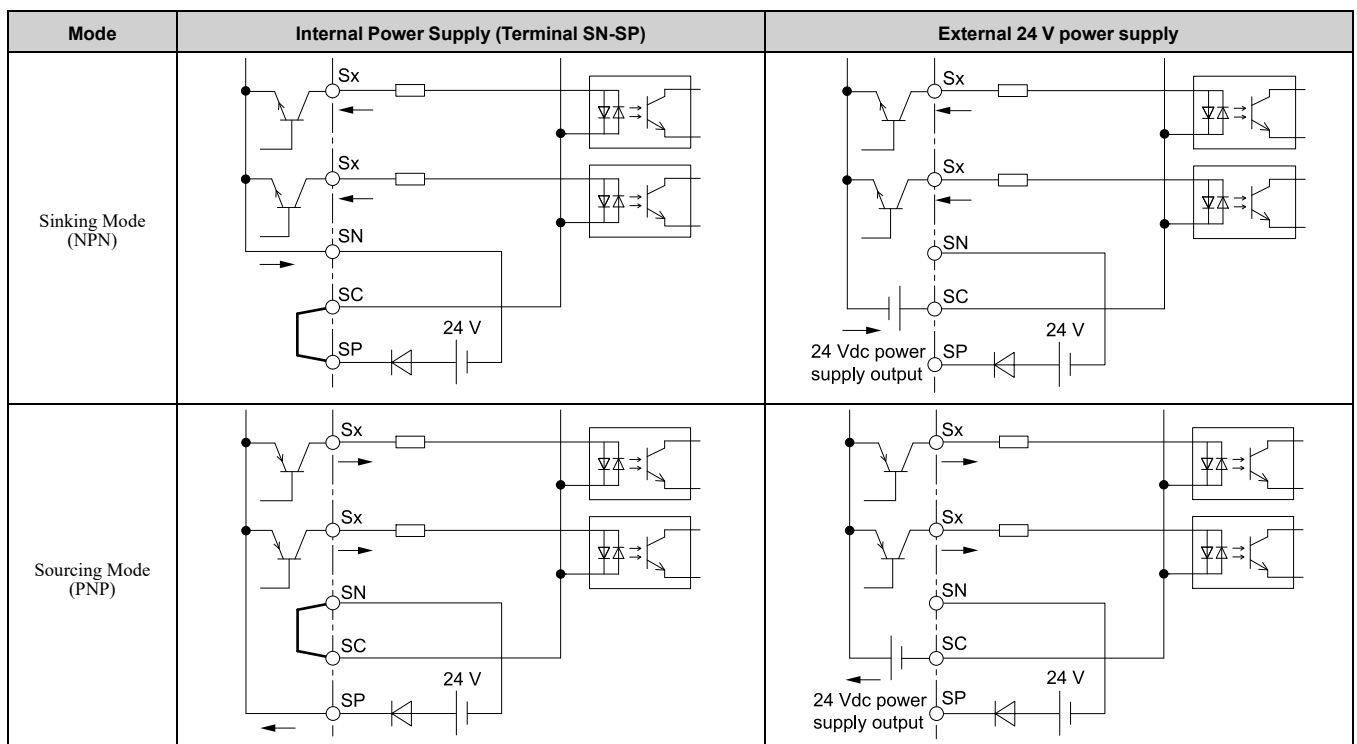

◆ Pulse Train Output

You can use pulse train monitor output terminal MP for sourcing mode or for sinking mode.

- Use for sourcing mode
The load impedance changes the voltage level of the pulse train output signal.

Load Impedance R_L (k Ω)	Output Voltage V_{MP} (V)
1.5 k Ω or more	5 V or more
4.0 k Ω or more	8 V or more
10 k Ω or more	10 V or more

Note:

Use the formula in [Figure 3.63](#) to calculate the necessary load resistance (k Ω) to increase output voltage V_{MP} (V).

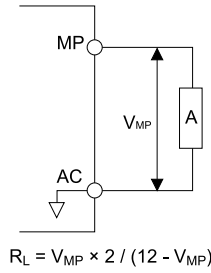

A - Load Impedance

Figure 3.63 Wiring to Use Pulse Train Output in Sourcing Mode

- Use in sinking mode

The external power supply changes the voltage level of the pulse train output signal. Keep the voltage from an external source between 10.8 Vdc to 16.5 Vdc. Adjust the load impedance to keep the current at 16 mA or lower.

External Power Supply (V)	Load Impedance (kΩ)	Sinking current (mA)
10.8 Vdc to 16.5 Vdc	1.0 kΩ or more	16 mA maximum

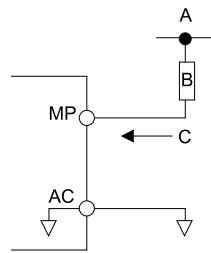

- A - External power supply**
- B - Load Impedance**

C - Sinking current

Figure 3.64 Wiring to Use Pulse Train Output in Sinking Mode

◆ **Set Input Signals for MFAI Terminals A1 to A3**

Use terminals A1 to A3 to input a voltage or a current signal. Set the signal type as shown in [Table 3.15](#).

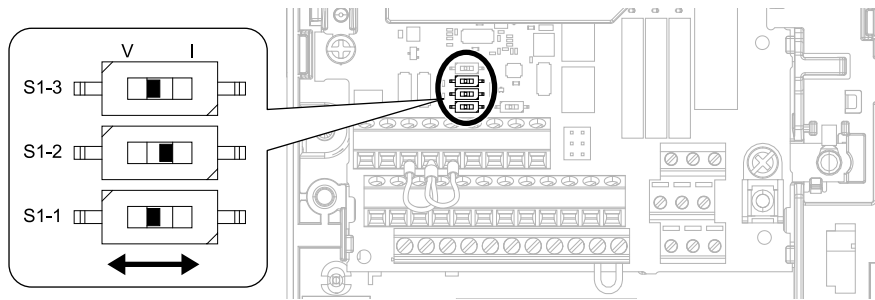

Figure 3.65 Location of DIP Switch S1

Table 3.15 MFAI Terminals A1 to A3 Signal Settings

Terminal	Input Signal	DIP Switch Settings		Parameter	
		Switch	Setting	No.	Signal Level
A1	Voltage input	S1-1	V (Default)	H3-01	0: 0 V to 10 V/0% to 100% (input impedance: 20 kΩ) 1: -10 V to +10 V/-100% to 100% (input impedance: 20 kΩ)
	Current input		I		2: 4 mA to 20 mA/0% to 100% (input impedance: 250 Ω) 3: 0 mA to 20 mA/0% to 100% (input impedance: 250 Ω)
A2	Voltage input	S1-2	V	H3-09	0: 0 V to 10 V/0% to 100% (input impedance: 20 kΩ) 1: -10 V to +10 V/-100% to 100% (input impedance: 20 kΩ)
	Current input		I (Default)		2: 4 mA to 20 mA/0% to 100% (input impedance: 250 Ω) 3: 0 mA to 20 mA/0% to 100% (input impedance: 250 Ω)

Terminal	Input Signal	DIP Switch Settings		Parameter	
		Switch	Setting	No.	Signal Level
A3	Voltage input	S1-3	V (Default)	H3-05	0: 0 V to 10 V/0% to 100% (input impedance: 20 kΩ) 1: -10 V to +10 V/-100% to 100% (input impedance: 20 kΩ)
	Current input		I		2: 4 mA to 20 mA/0% to 100% (input impedance: 250 Ω) 3: 0 mA to 20 mA/0% to 100% (input impedance: 250 Ω)

Note:

- Set H3-02, H3-10 = 0 [Terminal A1 Function Selection, Terminal A2 Function Selection = Frequency Reference] to set A1 and A2 to frequency reference. The drive will add the analog input values together to make the frequency reference.
- Use tweezers or a jig with a tip width of approximately 0.8 mm (0.03 in) to set DIP switches.
- Set DIP switch S4 to “AI” to use terminal A3 as an analog input (voltage/current) terminal. The default setting for DIP switch S4 is “AI”.

◆ **Set MFAI Terminal A3 to PTC Input**

Set terminal A3 as an MFAI or as the PTC input for motor overload protection. Use DIP switch S4 to set the input function.

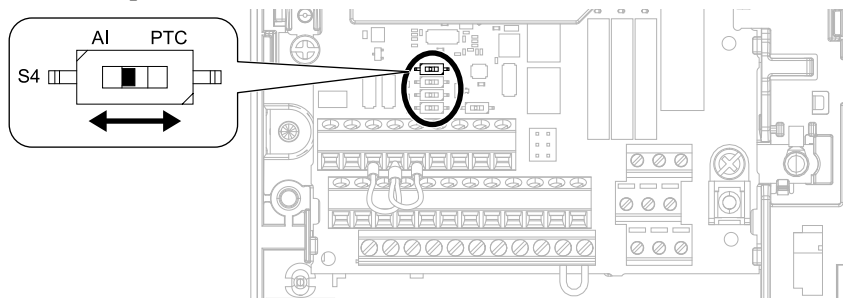

Figure 3.66 Location of DIP Switch S4

Terminal	DIP switch S4	Description
A3	AI (Default)	Functions as an MFAI terminal. Set H3-06 [Terminal A3 Function Selection] to set the input function.
	PTC	Functions as the PTC input terminal. Set H3-06 = E [Motor Temperature (PTC Input)]. Set S1-3 to “V” for voltage input.

◆ **Set Output Signals for MFAO Terminals FM, AM**

Set the signal type for terminals AM and FM to voltage or current output. Use jumper switch S5 and H4-07, H4-08 [Terminal FM Signal Level Select, Terminal AM Signal Level Select] to set the signal type.

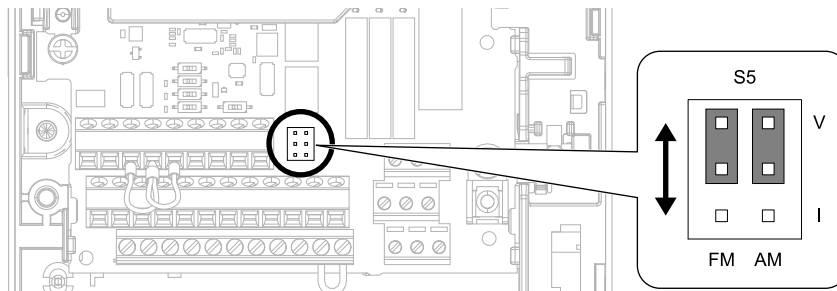
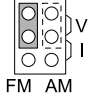
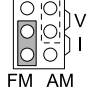
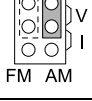



Figure 3.67 Location of Jumper Switch S5

3.6 Control I/O Connections

Terminal	Types of Output Signals	Jumper Switch S5	Parameter	
			No.	Signal Level
FM	Voltage output (Default)		H4-07	0: 0 V to 10 V 1: -10 V to +10 V
	Current output			2: 4 mA to 20 mA
AM	Voltage output (Default)		H4-08	0: 0 V to 10 V 1: -10 V to +10 V
	Current output			2: 4 mA to 20 mA

◆ Switch ON Termination Resistor for MEMOBUS/Modbus Communications

When the drive is the last slave in a MEMOBUS/Modbus communications, set DIP switch S2 to the ON position. This drive has a built-in termination resistor for the RS-485 interface.

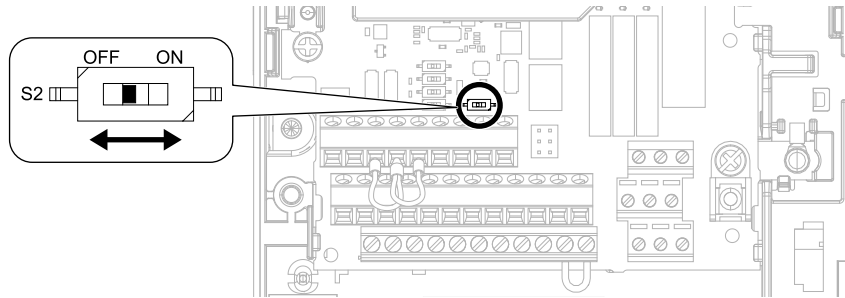

Figure 3.68 Location of DIP Switch S2

Table 3.16 MEMOBUS/Modbus Communications Termination Resistor Setting

DIP Switch S2	Description
ON	The built-in termination resistor is ON.
OFF (Default)	The built-in termination resistor is OFF.

3.7 Connect the Drive to a PC

The drive has a mini-B type USB port.

You can use a USB cable (USB 2.0, type: A - mini-B) to connect the drive to a type-A USB port on a PC. After you connect the drive to the PC, you can use Yaskawa DriveWizard Industrial software to monitor drive performance and manage parameter settings.

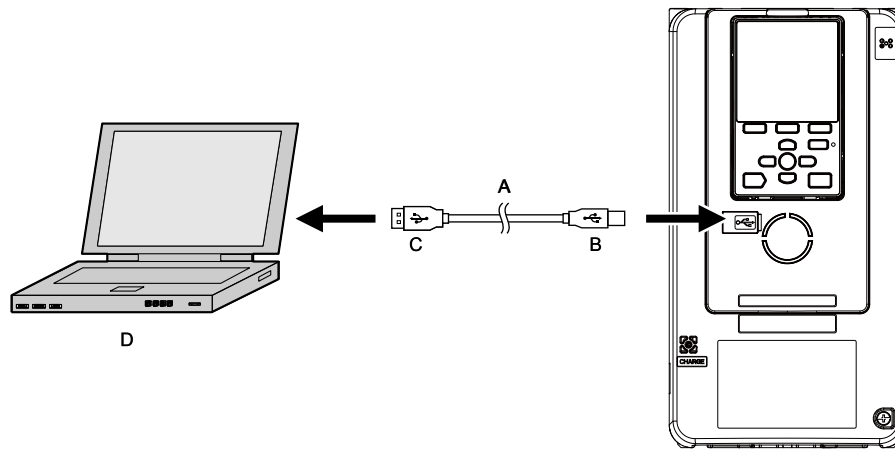

A - USB 2.0, type A - mini-B cable
B - Mini-B type connector

C - Type-A connector
D - PC

Figure 3.69 Connect to a PC (USB)

Yaskawa recommends that you use a USB cable with connectors connected with shielded wires.

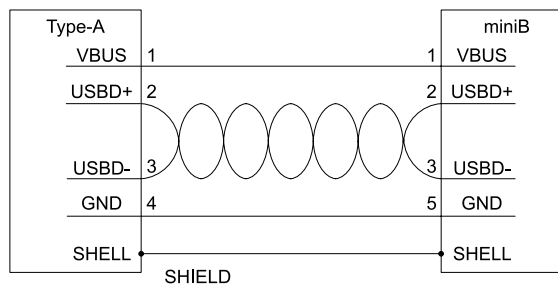

Figure 3.70 Recommended USB Cable

3.8 External Interlock

For applications that will have unwanted effects on the system if the drive stops, make an interlock between fault relay output (MA, MB, MC) and the MFDO Drive Ready signal.

◆ Drive Ready

When the drive is operating or is prepared to accept a Run command, the MFDO terminal to which *Drive Ready* [H2-xx = 6] is set will enter the ON status.

In these conditions, Drive Ready is OFF and the drive ignores Run commands:

- The drive is de-energized
- During a fault
- There is problem with the control power supply
- There is a parameter setting error that will not let the drive run, although a Run command is entered
- An overvoltage or undervoltage fault occurs when the Run command is entered
- The drive is in Programming Mode.

◆ Interlock Circuit Example

Refer to [Figure 3.71](#) for an example of how two drives that run one application use the Drive Ready and Fault output signals to interlock with the controller.

Terminal	Output Signal	Parameter Settings for Output Signal
MA, MB, MC	Fault	-
M1-M2	Drive Ready	H2-01 = 6

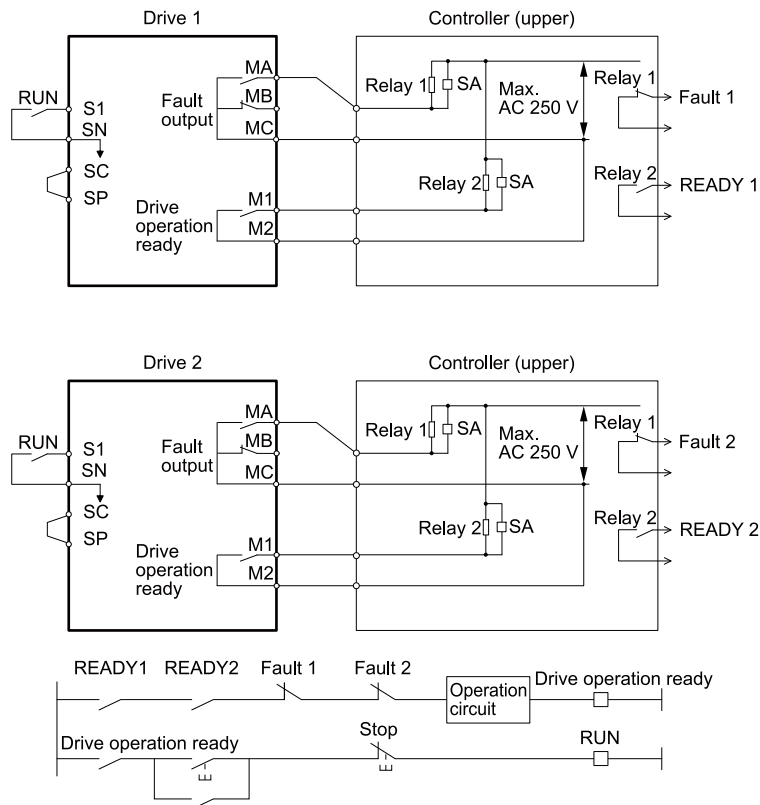

Figure 3.71 Interlock Circuit Example

3.9 Braking Resistor Installation

A braking resistor or braking resistor unit (dynamic braking option) helps stop the motor quickly and smoothly when there is high load inertia. If you try to decelerate a motor in less time than usual for a coast to stop, the motor will rotate faster than the synchronous speed that aligns with the set frequency. This will cause the motor to become an induction generator. The inertia energy of the motor and regenerate to the drive and charge the drive DC bus capacitor and increase the voltage. If the voltage is more than the overvoltage level, an *ov* [Overvoltage] will occur. To prevent these overvoltage faults, a dynamic braking option is necessary.

WARNING!

Set $L3-04 = 0$ [Stall Prevention during Decel = Disabled] when you operate the drive with:

- a regenerative converter
- regenerative unit
- braking unit
- braking resistor
- braking resistor unit.

If you set the parameter incorrectly, the drive can decelerate for too long and cause serious injury or death.

NOTICE: Damage to Equipment. Before you connect a dynamic braking option to the drive, make sure that qualified personnel read and obey the Braking Unit and Braking Resistor Unit Installation Manual (TOBPC72060001). If you do not read and obey the manual or if personnel are not qualified, it can cause damage to the drive and braking circuit.

Note:

- Select the correct braking circuit size to dissipate the power that is necessary to decelerate the load in the correct time. Before you run the drive, make sure that the braking circuit can dissipate the energy for the set deceleration time.
- To install a dynamic braking option, set $L8-01 = 0$ [3% ERF DB Resistor Protection = Disabled].

WARNING! Fire Hazard. Do not connect a braking resistor to terminals +1 or -. Use terminals B1 and B2 for the braking resistor connections. If you connect a braking resistor to the incorrect terminals, it can cause damage to the drive and braking circuit and serious injury or death.

NOTICE: Connect braking resistors to the drive as shown in the connection diagram examples. If you wire the braking circuits incorrectly, it can cause damage to the drive or equipment.

To connect a Yaskawa ERF series braking resistor to the drive, set $L8-01 = 1$ [Enabled].

To use a non-ERF type braking resistor, connect a thermal overload relay between the drive and the braking resistor, and set a circuit to de-energize the drive at the trip contacts of the thermal overload relay.

◆ Install a Braking Resistor: ERF-Type

Connect the braking resistor to drive models 2004 to 2021 and 4002 to 4012 as shown in [Figure 3.72](#).

When you use a braking resistor, set $L8-01 = 1$ [3% ERF DB Resistor Protection = Enabled] and set one of the MFDO parameters $H2-01$ to $H2-03 = D$ [MFDO Function Select = Braking Resistor Fault]. Use a sequence that uses MFDO to de-energize the drive.

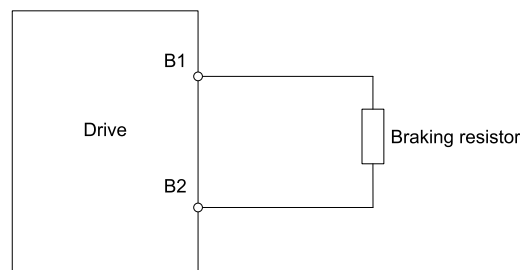

Figure 3.72 Install a Braking Resistor: ERF-Type

◆ Install a Braking Resistor Unit: LKEB-Type

Connect the braking resistor unit as shown in [Figure 3.73](#). To install a braking resistor unit, set $L8-01 = 0$ [3% ERF DB Resistor Protection = Disabled].

Models 2004 to 2138 and 4002 to 4168 have a built-in braking transistor.

To prevent overheating the braking resistor unit, set a sequence to de-energize the drive at the trip contacts of the thermal overload relay.

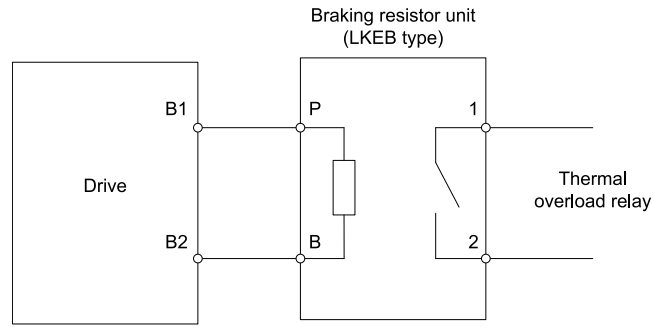

Figure 3.73 Install a Braking Resistor Unit: LKEB-Type

◆ Install a Braking Unit Connection: CDBR-Type

To install a CDBR-type braking unit, connect terminal +3 on the drive to terminal + on the braking unit, and connect terminal - on the drive to terminal - on the braking unit. Terminal +2 on the drive is not necessary for CDBR-type braking unit connections.

Set $L8-55 = 0$ [Internal DB Transistor Protection = Disable].

Note:

- To install a CDBR-type braking unit to the drive models 2004 to 2138 and 4002 to 4168 that have a built-in braking transistor, connect drive terminal B1 to terminal + on the braking unit.
- A junction terminal is necessary to connect a braking unit (CDBR-series) to drive models 2169, 2211, 4140, or 4168. To wire the braking unit, install a junction terminal that can connect to wires in the range specified for the drive, peripheral devices, and options. This table shows recommended junction terminals. Contact Yaskawa or your nearest sales representative for more information about selection and installation of the junction terminal.

Drive Model	Junction Terminal Model Manufacturer: Mibu Denki Industrial Co., Ltd.
2169, 4140, 4168	DTK-200N × 2P *1
2211	DTK-300N × 2P *1

*1 The junction terminal must have two or more poles.

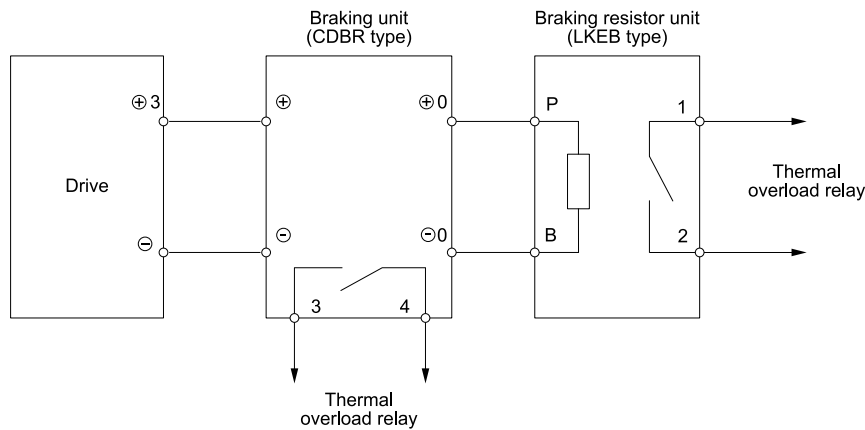

Figure 3.74 Install a Braking Unit: CDBR-Type/Braking Resistor Unit: LKEB-Type

■ Braking Unit Connection Wire Gauge (CDBR-Type)

To comply with IP20 when you connect the braking unit (CDBR-type) to drive models 2257 to 2415 or 4208 to 4675, refer to [Table 3.17](#) and [Table 3.18](#) to select the wires.

Table 3.17 200 V Class

Drive Model	Braking Unit (Qty)	Drive Terminals	Recomm. Gauge (mm ²)	Applicable Gauge (mm ²)	Ref.
2257	CDBR-2022D (× 2) Specified Wire Gauge	+3	6 × 2P	6 - 10 × 2P	Figure 3.75
		-	6 × 2P	6 - 10 × 2P	Figure 3.75
	Applicable Gauge *1	+3	35 × 2P	25 - 70 × 2P	Figure 3.76
		-	35 × 2P *2	25 - 70 × 2P *2	Figure 3.76
2313	CDBR-2110D (× 1) Specified Wire Gauge	+3	35	35	Figure 3.75
		-	35	35	Figure 3.75
	Applicable Gauge *1	+3	50 × 2P	25 - 70 × 2P	Figure 3.76
		-	50 × 2P *2	25 - 70 × 2P *2	Figure 3.76
2360	CDBR-2110D (× 1) Specified Wire Gauge	+3	35	35	Figure 3.77
		-	35	35	Figure 3.77
2415	CDBR-2110D (× 1) Specified Wire Gauge	+3	35	35	Figure 3.77
		-	35	35	Figure 3.77

*1 This is the applicable wire gauge when you use a braking unit other than Yaskawa braking unit (CDBR-type).

*2 This is the applicable wire gauge when you use the same wires for terminals - and +3.

Table 3.18 400 V Class

Drive Model	Braking Unit (Qty)	Drive Terminals	Recomm. Gauge (mm ²)	Applicable Gauge (mm ²)	Ref.
4208	CDBR-4045D (× 2) Specified Wire Gauge	+3	6 × 2P	6 - 10 × 2P	Figure 3.75
		-	6 × 2P	6 - 10 × 2P	Figure 3.75
	Applicable Gauge *1	+3	35 × 2P	25 - 70 × 2P	Figure 3.76
		-	35 × 2P *2	25 - 70 × 2P *2	Figure 3.76
4250	CDBR-4220D (× 1) Specified Wire Gauge	+3	35	35	Figure 3.75
		-	35	35	Figure 3.75
	Applicable Gauge *1	+3	50 × 2P	25 - 70 × 2P	Figure 3.76
		-	50 × 2P *2	25 - 70 × 2P *2	Figure 3.76
4296	CDBR-4220D (× 1) Specified Wire Gauge	+3	35	35	Figure 3.75
		-	35	35	Figure 3.75
	Applicable Gauge *1	+3	70 × 2P	25 - 70 × 2P	Figure 3.76
		-	70 × 2P *2	25 - 70 × 2P *2	Figure 3.76
4371	CDBR-4220D (× 1) Specified Wire Gauge	+3	35	35	Figure 3.77
		-	35	35	Figure 3.77
4389	CDBR-4220D (× 1) Specified Wire Gauge	+3	35	35	Figure 3.77
		-	35	35	Figure 3.77
4453	CDBR-4220D (× 1) Specified Wire Gauge	+3	35	35	Figure 3.78
		-	35	35	Figure 3.78
	Applicable Gauge *1	+3	70 × 4P	35 - 95 × 4P	Figure 3.80
		-	70 × 4P *2	35 - 95 × 4P *2	Figure 3.80
4568	CDBR-4220D (× 1) Specified Wire Gauge	+3	35	35	Figure 3.78
		-	35	35	Figure 3.78
	Applicable Gauge *1	+3	70 × 4P	35 - 95 × 4P	Figure 3.80
		-	70 × 4P *2	35 - 95 × 4P *2	Figure 3.80

3.9 Braking Resistor Installation

Drive Model	Braking Unit (Qty)	Drive Terminals	Recomm. Gauge (mm ²)	Applicable Gauge (mm ²)	Ref.
4675	CDBR-4220D (× 2) Specified Wire Gauge	+3	35 × 2P	35 × 2P	Figure 3.79
		-	35 × 2P	35 × 2P	Figure 3.79
	Applicable Gauge *1	+3	70 × 4P	35 - 95 × 4P	Figure 3.80
		-	70 × 4P *2	35 - 95 × 4P *2	Figure 3.80
4810	CDBR-4220D (× 3) Specified Wire Gauge	+3	35 × 3P	35 × 3P	-
		-	35 × 3P	35 × 3P	-
	Applicable Gauge *1	+3	70 × 4P	70 - 150 × 4P	-
		-	70 × 4P *2	70 - 150 × 4P *2	-
4930	CDBR-4220D (× 3) Specified Wire Gauge	+3	35 × 3P	35 × 3P	-
		-	35 × 3P	35 × 3P	-
	Applicable Gauge *1	+3	95 × 4P	70 - 150 × 4P	-
		-	95 × 4P *2	70 - 150 × 4P *2	-
4H11	CDBR-4220D (× 3) Specified Wire Gauge	+3	35 × 3P	35 × 3P	-
		-	35 × 3P	35 × 3P	-
	Applicable Gauge *1	+3	35 × 4P × 2	35 - 150 × 4P × 2	-
		-	35 × 4P × 2 *2	35 - 150 × 4P × 2 *2	-
4H12	CDBR-4220D (× 3) Specified Wire Gauge	+3	35 × 3P	35 × 3P	-
		-	35 × 3P	35 × 3P	-
	Applicable Gauge *1	+3	50 × 4P × 2	35 - 150 × 4P × 2	-
		-	50 × 4P × 2 *2	35 - 150 × 4P × 2 *2	-

*1 This is the applicable wire gauge when you use a braking unit that is not a Yaskawa braking unit (CDBR-type).

*2 This is the applicable wire gauge when you use the same wires for terminals - and +3.

■ Cutaway Section of the Wiring Cover

Examine the terminal symbols on the braking unit and use a nipper to clip the cutaway section of the corresponding wiring cover.

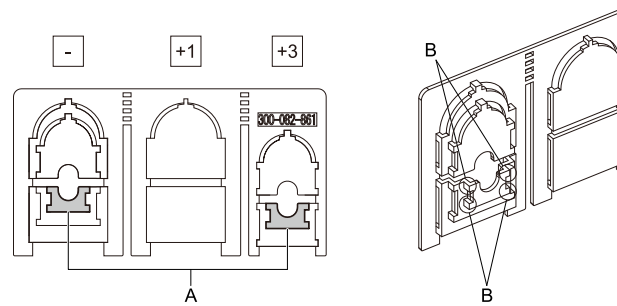

A - Cutaway sections

B - Use a diagonal-cutting pliers to clip this area.

Figure 3.75 Cutaway Sections

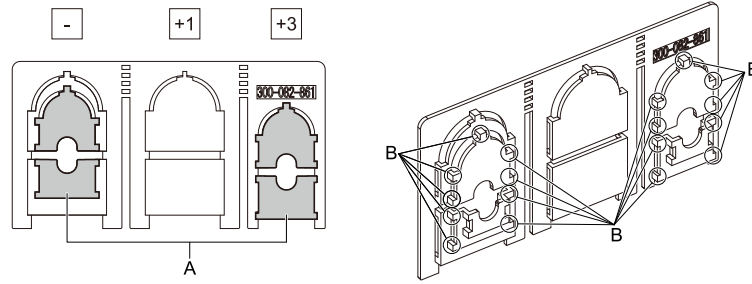

A - Cutaway sections

B - Use a diagonal-cutting pliers to clip this area.

Figure 3.76 Cutaway Sections

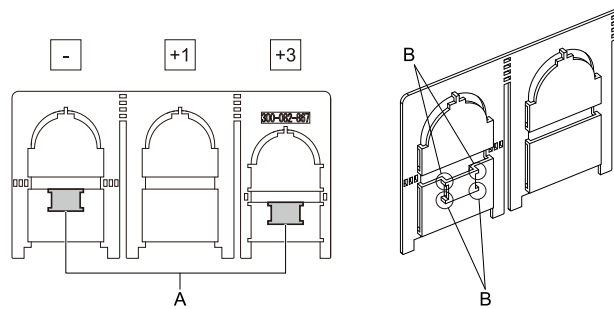

A - Cutaway sections

B - Use a diagonal-cutting pliers to clip this area.

Figure 3.77 Cutaway Sections

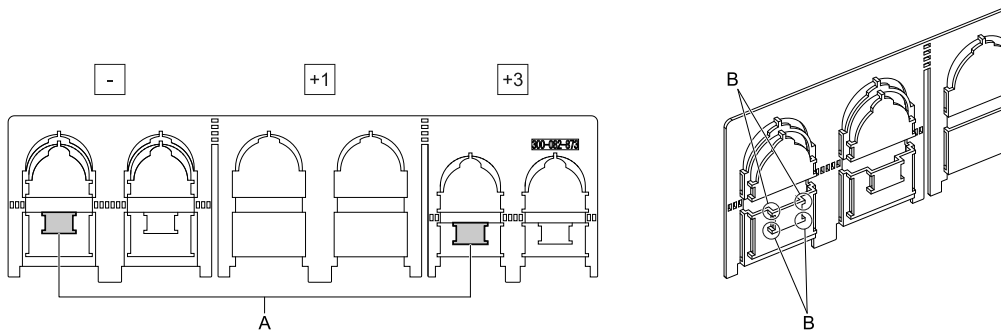

A - Cutaway section *1

B - Use a diagonal-cutting pliers to clip this area.

Figure 3.78 Cutaway Sections

*1 Cut away either of the two portions: terminal - or terminal +3. You may cut away either portion.

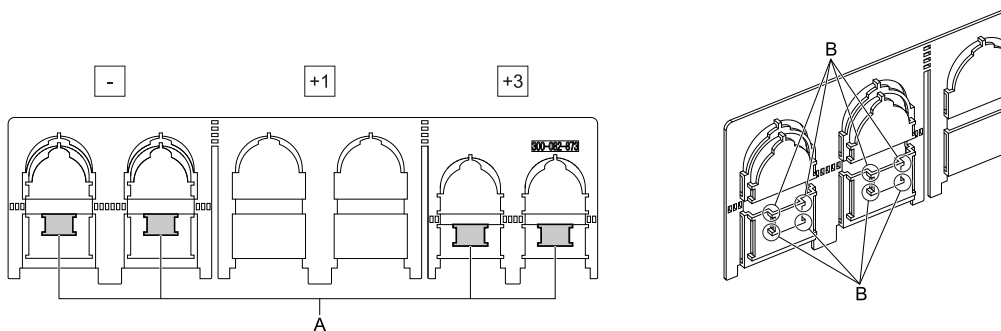

A - Cutaway sections

B - Use a diagonal-cutting pliers to clip this area.

Figure 3.79 Cutaway Sections

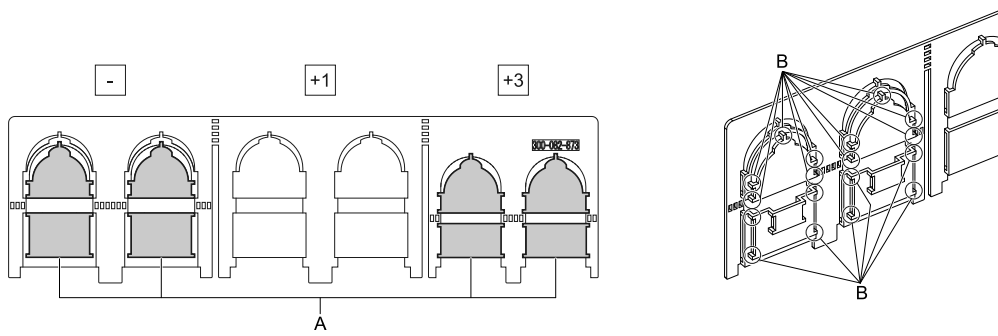

A - Cutaway sections

B - Use a diagonal-cutting pliers to clip this area.

Figure 3.80 Cutaway Sections

■ Installing a Braking Unit Connection (CDBR-Type)

Remove the terminal cover before you connect the braking unit (CDBR-type) to the drive.

1. Remove the screws on the terminal block cover and pull the terminal block cover away from the terminal block. Pull the wiring cover away from the drive to remove the wiring cover after removing the terminal block cover.

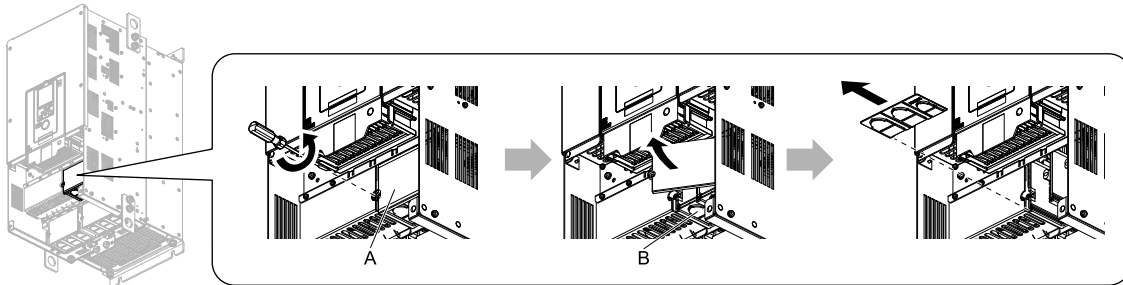

A - Terminal block cover

B - Wiring cover

Figure 3.81 Remove the Wiring Cover

2. Examine the signal from the wired terminal and use a diagonal-cutting pliers to remove areas of the wiring cover cutaway section.

Refer to [Cutaway Section of the Wiring Cover on page 124](#) for more information.

Note:

- Different drive models have different wiring covers.
- Only clip the section of the wiring cover that applies to the wired terminal. If you clip areas that do not apply to wired terminals, the protective enclosure will not keep its IP20 protective level.
- Make sure that you hold the cutaway section tightly when you remove pieces of the cutaway section. Pieces of the cutaway section can fly out and cause injury.
- Make sure that the clipped section does not cause damage to the wires.
- If you use wires that are not specified by Yaskawa, the protective enclosure could lose its IP20 protective level, although the wiring cover is correct. Contact Yaskawa or your nearest sales representative for more information.
- When you use the recommended gauge for the electrical wires, it is not necessary to attach the wiring cover of the main circuit power input terminal and the drive output terminal. If you use the applicable gauge for the electrical wires, you must attach the wiring cover.

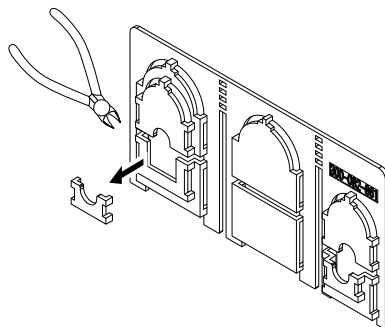
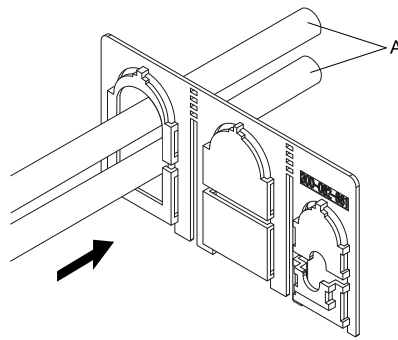

Figure 3.82 Clip the Cutaway Section of the Wiring Cover

- Put the wires through the holes that you cut out of the wiring cover.



A - Wire

Figure 3.83 Lead the Wire through the Wiring Cover

- Crimp the closed-loop crimp terminal to the wire.
- Remove the main circuit terminal block nut.

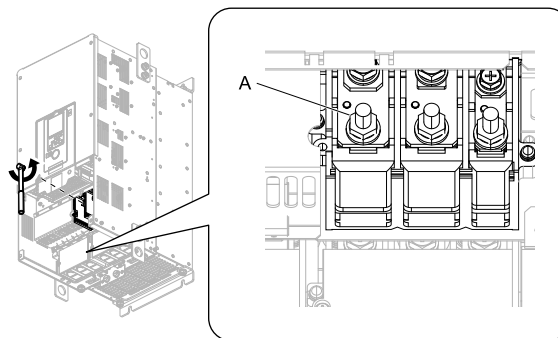

A - Nut

Figure 3.84 Remove the Terminal Block Nut

- Wire the closed-loop crimp terminal to the main circuit terminal block.

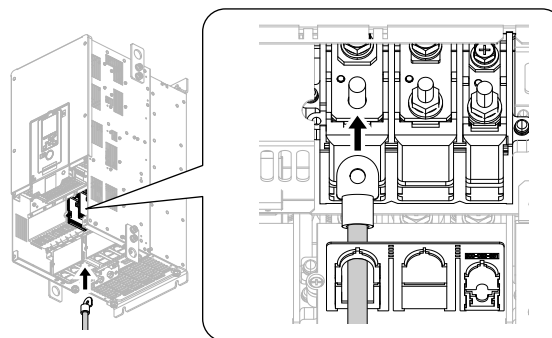

Figure 3.85 Connect the Wire

- Tighten the nut to the specified torque.

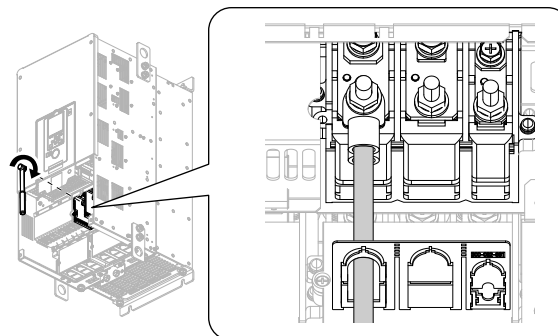

Figure 3.86 Tighten the Terminal Block Nut

- Attach the wiring cover and terminal block cover to their initial positions and tighten the screws on the terminal block cover.

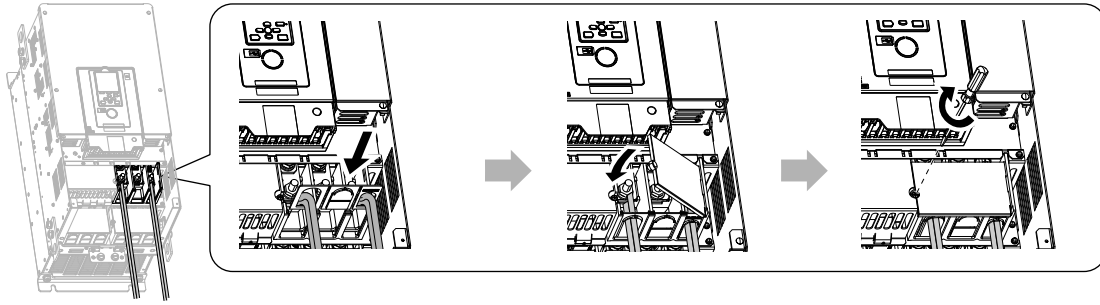

Figure 3.87 Reattach the Wiring Cover

- Put the terminal cover back in its initial position.

◆ Connect Braking Units in Parallel

To connect two or more braking units in parallel, refer to [Figure 3.88](#) for wiring and connector selections.

Braking units have connectors to select master or slave. On the first braking unit, select the master side. On the second unit and all subsequent units, select the slave side.

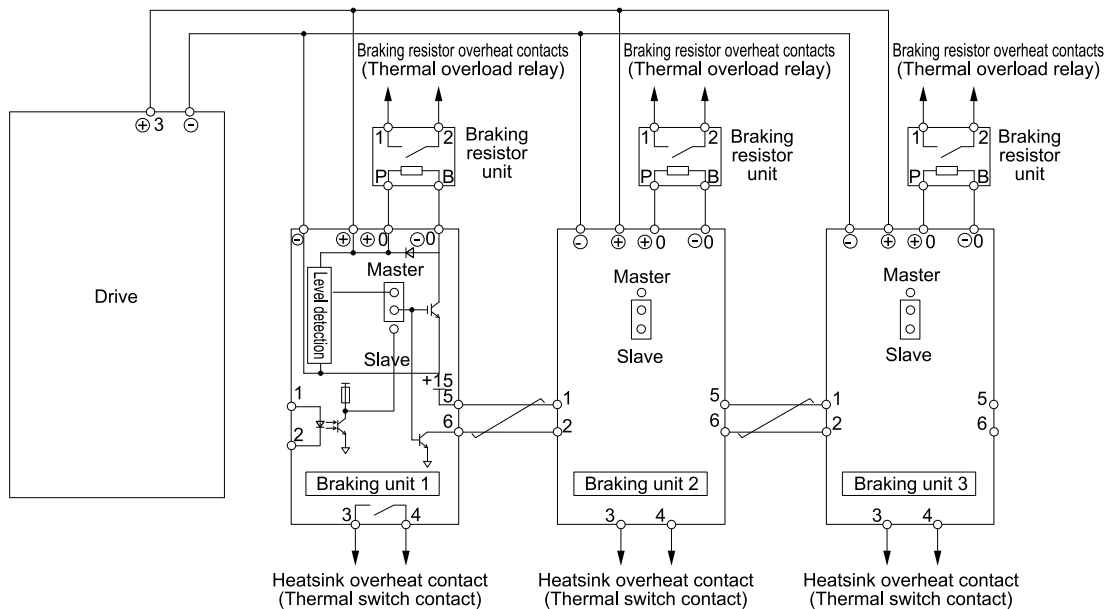

Figure 3.88 Connect Braking Units in Parallel

◆ Dynamic Braking Option Overload Protection

To prevent overheating the dynamic braking option, set a sequence to de-energize the drive at the trip contacts of the thermal overload relay.

3.10 Drive Wiring Protection

◆ Installing a Residual Current Monitoring/Detection (RCM/RCD)

If the drive output switches at high speeds, it causes high frequency leakage current. To prevent electrical shock and fires caused by ground fault protection that is not sufficient, install an RCM/RCD.

Use a high frequency RCM/RCD at the power input side of the drive and make sure that each drive has a minimum cumulative sensitivity amperage of 30 mA. The specialized breaker only detects the leakage current from frequency bands that are dangerous to humans.

If a device does not have protection against high frequencies, high frequency leakage currents can cause the device to malfunction. If you have a malfunction on a device that does not have protection, decrease the carrier frequency of the drive, install a better breaker, or use an RCM/RCD with a minimum cumulative sensitivity amperage of 200 mA for each drive.

These conditions can have an effect on leakage current:

- Drive capacity
- Carrier frequency
- Wiring distance and types of motor cables
- EMI/RFI filter

To prevent damage and injury to personnel and drives, use a high-frequency RCM/RCD that is rated for AC and DC power supplies.

Note:

Yaskawa recommends these RCMs/RCDs, which are designed to operate with high frequencies:

- Mitsubishi Electric Corporation, NV series
- Schneider Electric, NS series

You can use a molded-case circuit breaker (MCCB) as a replacement for an RCM/RCD that is upstream in the power supply system.

◆ Installing a Molded-Case Circuit Breaker (MCCB) or Residual Current Monitor/Device (RCM/RCD)

Install a molded-case circuit breaker (MCCB) or a residual current monitor/device (RCM/RCD) for line protection between the power supply and main circuit power supply input terminals R/L1, S/L2, and T/L3. The MCCB or RCM/RCD gives overload protection and also prevent damage to the main circuit and the devices that are wired to the main circuit.

Use the information in this section to select the correct MCCB or RCM/RCD and to safely connect the device.

- The capacity of the MCCB or RCM/RCD must be 1.5 to 2 times the rated output current of the drive. Use an MCCB or RCM/RCD as an alternative to overheat protection (150% for one minute at the rated output current) to prevent drive faults.
- When you connect more than one drive or the drive and other device to an MCCB or RCM/RCD, refer to [Figure 3.90](#), use a magnetic contactor (MC), and set a sequence that de-energizes the drive when it outputs errors.

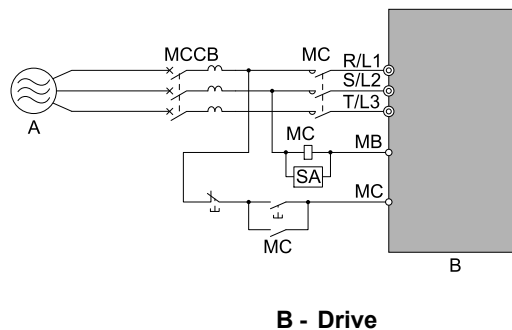

A - Power supply

B - Drive

Figure 3.90 Connect an MCCB

WARNING! Electrical Shock Hazard. Use an MCCB, RCM/RCD, or Magnetic Contactor (MC) to de-energize the drive before you wire the main circuit terminal. If the main circuit terminal is energized during wiring, it will cause serious injury or death.

3.11 Dynamic Braking Option, Motor Protection

◆ Install an Electromagnetic Contactor (MC) at the Input Side of the Drive

You can use an MC as an alternative to a molded case circuit breaker (MCCB) when:

- The protective functions of the drive have been triggered
- An emergency stop occurred, and the sequence de-energizes the drive.

If an MC on the input side of the drive (primary side) stops the drive, regenerative braking will not operate, and the drive will coast to stop.

NOTICE: *When you connect electromagnetic switches or magnetic contactors to the output motor circuits, make sure that you sequence them correctly. If the output motor circuit sequence is incorrect, it can cause damage to the drive.*

NOTICE: *Damage to Equipment. Do not energize and de-energize the drive more frequently than one time each 30 minutes. If you frequently energize and de-energize the drive, it can cause drive failure.*

Note:

- When machinery must not restart after recovery from a momentary power loss that occurred during run, install an MC at the input side of the drive and set a sequence that does not automatically set the Run command to ON after recovery of power.
- When it is necessary to stop momentary power loss, for example to maintain a circuit that has momentary power loss, use a delayed-release MC.
- Use an MC (magnetic contactor) to make sure that you can fully remove power to the drive when necessary. Wire the MC to open when a fault output terminal is triggered.

■ Protect the Braking Resistor/Braking Resistor Unit

Use an MC on the input side (primary side) to prevent damage to the braking resistor/braking resistor unit.

WARNING! *Fire Hazard. When you use a braking unit, use a thermal relay on the braking resistors and set a fault contact output for the braking resistor unit to disconnect drive main power through an input contactor. Incorrect braking circuit protection can cause the resistors to become too hot and cause serious injury or death.*

◆ Installing a Thermal Overload Relay on the Drive Output

A thermal overload relay disconnects the power line to the motor during a motor overload condition to prevent damage to the motor.

Install a thermal overload relay between the drive and motor in these conditions:

- When you operate more than one motor with one drive
- When you operate the motor directly from the power line with a power line bypass

When you operate one motor with one drive, it is not necessary to install a thermal overload relay. The drive has electronic motor overload protection in the drive software.

Note:

- When you install a thermal overload relay, set parameter $L1-01 = 0$ [*Motor Overload (oLI) Protection = Disabled*].
- Set up a sequence that will trip an external fault (coast to stop) for the contacts of the thermal overload relay.

■ General Precautions When Using Thermal Overload Relays

When you use a motor thermal overload relay on the drive output to prevent nuisance trips and overheating of the motor at low speeds, be sure to think about these application precautions:

- Operation of a low speed motor
- When you operate more than one motor with one drive
- Length of the motor cables
- Nuisance tripping because of high drive carrier frequency

Operation of a Low Speed Motor

Usually, you use thermal overload relays on general-purpose motors (standard motors). When a drive drives a general-purpose motor, the motor current is approximately 5% to 10% more than with a commercial power supply. When a motor with a shaft-driven fan operates at low speeds, the cooling capacity decreases. This can cause the motor to overheat when the load current is in the motor rated value. Enable the electronic thermal protection in the drive when possible to prevent this problem.

The electronic thermal overload function uses the relation between the speed and heat characteristics in the variable speed control range to simulate the cooling ability of general-purpose motors and forced-vented motors to prevent damage to the motor.

When You Operate More than One Motor with One Drive

To disable the overload protection function of the electronic thermal protector of the drive, set $LI-01 = 0$ [*Motor Overload (oL1) Protection = Disabled*].

Note:

If you operate more than one motor from one drive, you cannot use the electronic thermal protection of the drive.

Length of the Motor Cables

If you use long motor cables with a high carrier frequency, the increased leakage current can cause nuisance tripping of the thermal relay. To prevent this, decrease the carrier frequency or increase the tripping level of the thermal overload relay.

Nuisance Tripping Because of High Drive Carrier Frequency

High carrier frequency PWM drives make current waveforms that can increase the temperature in overload relays. It may be necessary to increase the trip level setting when encountering nuisance triggering of the relay.

WARNING! Fire Hazard. Before you increase the detection level of the thermal relay, make sure that a secondary problem is not the cause of the overload. Make sure that you know the local codes for electrical wiring, then adjust the electrothermal settings. Incorrect thermal relay adjustment and incorrect wiring can cause serious injury or death.

3.12 Improve the Power Factor

◆ Connect an AC Reactor or a DC Reactor

AC reactors and DC reactors decrease surges in current and improve the power factor on the input side of the drive.

Connect an AC reactor or a DC reactor to the input side (primary side) in these conditions:

- To decrease harmonic current or improve the power factor of the power supply
- When there is switching of phase advancing capacitor
- With a large capacity power supply transformer (600 kVA or more).

Note:

- You can use an AC reactor and DC reactor together.
- When you connect a thyristor converter (for example, a DC drive) to the same power supply system, use an AC reactor.
- The main circuit terminal block for the drive and the terminal blocks for the AC and DC reactors come in different shapes. Correctly prepare the ends of the wiring.
- Ground the AC and DC reactors (option) on the back of the mounting base. Remove all paint from the mounting surface of the control panel.

■ Connect an AC Reactor

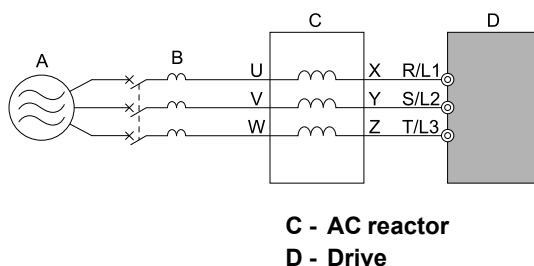

Figure 3.91 AC Reactor Connection Example

■ Connect a DC Reactor

When you install a DC link choke, remove the jumper between terminals +1 and +2. If you will not use a DC link choke, do not remove the jumper. Refer to [Figure 3.92](#) for an example of how to wire the DC reactor.

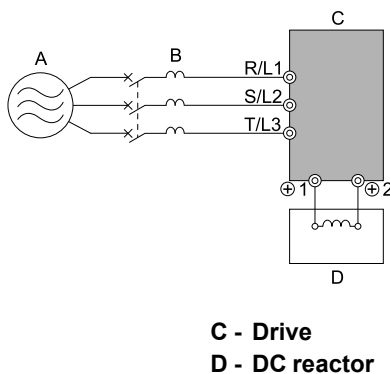

Figure 3.92 DC Reactor Connection Example

3.13 Prevent Switching Surge

◆ Connect a Surge Protective Device

A surge protective device decreases the surge voltage generated when you switch an inductive load near the drive. Inductive loads include:

- Magnetic contactors
- Electromagnetic relays
- Magnetic valves
- Solenoids
- Magnetic brakes.

Always use a surge protective device or diode with inductive loads.

Note:

Do not connect a surge protective device to the drive output side.

3.14 Decrease Noise

◆ Connect a Noise Filter to the Input Side (Primary Side)

High-speed switching makes noise in the drive output. This noise flows from the drive to the power supply, and can have an effect on other equipment. Install a noise filter to the input side of the drive to decrease the quantity of noise that flows to the power supply. A noise filter will also stop noise from entering the drive from the power supply.

- Use a noise filter specially designed for drives.
- Install the noise filter as close as possible to the drive.

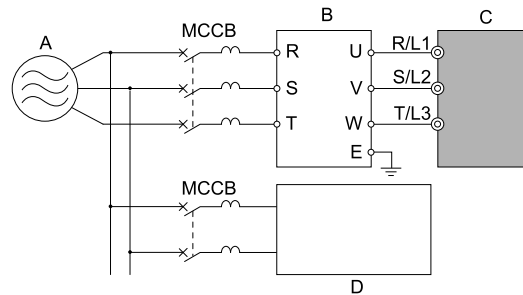

A - Power Supply

B - Input side (primary side) noise filter

C - Drive

D - Other controller

Note:

The input side (primary side) noise filter model is LNFD-xx.

Figure 3.93 Example of Connecting the Noise Filter on the Input Side (Primary Side)

◆ Connect a Noise Filter to the Output Side (Secondary Side)

A noise filter on the output side of the drive decreases inductive noise and radio frequency interference.

Figure 3.94 shows an example of noise filter wiring.

NOTICE: Do not connect phase-advancing capacitors, LC/RC noise filters, or leakage breakers (RCM/RCD) to the motor circuit. If you connect these devices to the output circuits, it can cause damage to the drive and connected equipment.

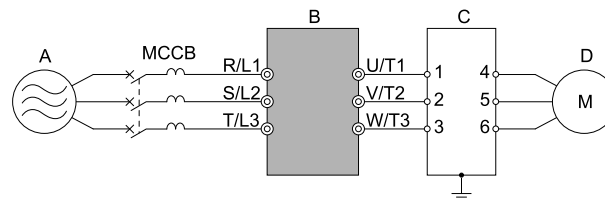

A - Power supply

B - Drive

C - Noise filter on output side (secondary side)

D - Motor

Figure 3.94 Example of Connecting the Noise Filter on the Output Side (Secondary Side)

Note:

Glossary

- Radio frequency interference:

Electromagnetic waves radiated from the drive and cables make noise through the full radio bandwidth that can have an effect on nearby devices.

- Inductive noise:

The noise from electromagnetic induction can have an effect on the signal line and can cause the controller to malfunction.

■ Prevent Inductive Noise

In addition to installing a noise filter, you can also run all wiring through a grounded metal conduit to decrease inductive noise occurring at the output side. Put the cables a minimum of 30 cm (11.8 in) away from the signal line to prevent induced noise. Ground the cables to metal conduits.

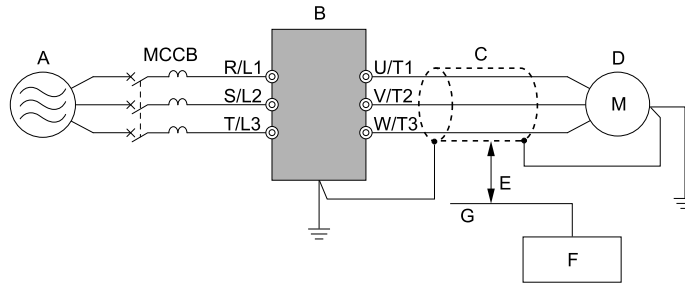

- A - Power supply
- B - Drive
- C - Shielded motor cable
- D - Motor

- E - Minimum of 30 cm (11.8 in) apart
- F - Controller
- G - Signal line

Figure 3.95 Prevent Inductive Noise

■ Decrease Radio Frequency Interference

The drive, input lines, and output lines generate radio frequency interference. Use noise filters on input and output sides and install the drive in a steel box to decrease radio frequency interference.

Note:

Keep the cable between the drive and motor as short as possible.

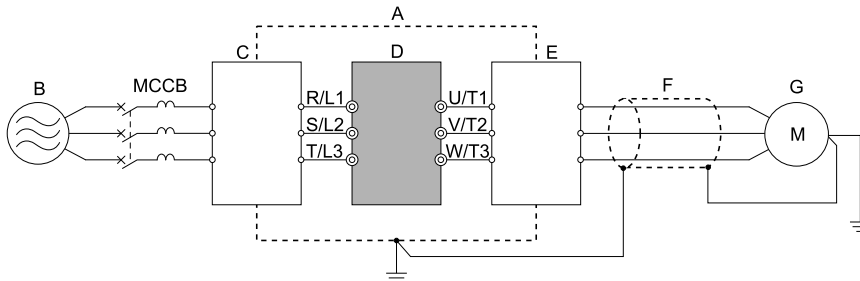

- A - Steel box
- B - Power supply
- C - Noise filter
- D - Drive

- E - Noise filter
- F - Shielded motor cable
- G - Motor

Figure 3.96 Decrease Radio Frequency Interference

3.15 Protect the Drive during Failures

◆ Factory-Recommended Branch Circuit Protection for UL Listing

Use branch circuit protection to protect against short circuits and to maintain compliance with UL 61800-5-1. Yaskawa recommends connecting semiconductor protection fuses on the input side for branch circuit protection. Refer to *Three-Phase 200 V Class on page 137* and *Three-Phase 400 V Class on page 138* for more information about recommended fuses.

WARNING! Electrical Shock Hazard. After the drive blows a fuse or trips an RCM/RCD, do not immediately energize the drive or operate peripheral devices. Wait for the time specified on the warning label at a minimum and make sure that all indicators are OFF. Then check the wiring and peripheral device ratings to find the cause of the problem. If you do not know the cause of the problem, contact Yaskawa before you energize the drive or peripheral devices. If you do not fix the problem before you operate the drive or peripheral devices, it can cause serious injury or death.

- 200 V Class
Use the fuses specified in this document to prepare the drive for use on a circuit that supplies not more than 100,000 RMS and not more than 240 Vac when there is a short circuit in the power supply.
- 400 V Class
Use the fuses specified in this document to prepare the drive for use on a circuit that supplies not more than 100,000 RMS and not more than 480 Vac when there is a short circuit in the power supply.

The built-in short circuit protection of the drive does not provide branch circuit protection. The user must provide branch circuit protection as specified by the National Electric Code (NEC), the Canadian Electric Code, Part I (CEC), and local codes.

■ Three-Phase 200 V Class

Table 3.19 Factory-Recommended Branch Circuit Protection: 200 V Class (ND)

Drive Model	Maximum Applicable Motor Output kW (HP)	Input Current Rating A	Semiconductor Protection Fuse Rated Current Manufacturer: EATON/Bussmann
2004	0.75 (0.75)	4.8	FWH-45B
2006	1.1 (1.5)	6.7	FWH-45B
2010	2.2 (3)	12.7	FWH-45B
2012	3 (4)	17	FWH-50B FWH-80B ^{*1}
2018	3.7 (5)	20.7	FWH-80B FWH-100B ^{*1}
2021	5.5 (7.5)	30	FWH-80B FWH-100B ^{*1}
2030	7.5 (10)	40.3	FWH-125B
2042	11 (15)	52	FWH-150B
2056	15 (20)	78.4	FWH-200B
2070	18.5 (25)	96	FWH-225A
2082	22 (30)	114	FWH-225A FWH-250A ^{*1}
2110	30 (40)	111	FWH-225A FWH-250A ^{*1}
2138	37 (50)	136	FWH-275A FWH-300A ^{*1}
2169	45 (60)	164	FWH-275A FWH-350A ^{*1}
2211	55 (75)	200	FWH-325A FWH-450A ^{*1}
2257	75 (100)	271	FWH-600A
2313	90 (125)	324	FWH-800A
2360	110 (150)	394	FWH-1000B
2415	-	-	-

*1 Yaskawa recommends a fuse with a large rated current for applications with repeated loads.

Table 3.20 Factory-Recommended Branch Circuit Protection: 200 V Class (HD)

Drive Model	Maximum Applicable Motor Output kW (HP)	Input Current Rating A	Semiconductor Protection Fuse Rated Current Manufacturer: EATON/Bussmann
2004	0.55 (0.5)	3.6	FWH-45B
2006	0.75 (1)	4.8	FWH-45B
2010	1.5 (2)	8.9	FWH-45B
2012	2.2 (3)	12.7	FWH-50B FWH-80B <i>*/</i>
2018	3 (4)	17	FWH-80B FWH-100B <i>*/</i>
2021	3.7 (5)	20.7	FWH-80B FWH-100B <i>*/</i>
2030	5.5 (7.5)	30	FWH-125B
2042	7.5 (10)	40.3	FWH-150B
2056	11 (15)	58.2	FWH-200B
2070	15 (20)	78.4	FWH-225A
2082	18.5 (25)	96	FWH-225A FWH-250A <i>*/</i>
2110	22 (30)	82	FWH-225A FWH-250A <i>*/</i>
2138	30 (40)	111	FWH-275A FWH-300A <i>*/</i>
2169	37 (50)	136	FWH-275A FWH-350A <i>*/</i>
2211	45 (60)	164	FWH-325A FWH-450A <i>*/</i>
2257	55 (75)	200	FWH-600A
2313	75 (100)	271	FWH-800A
2360	90 (125)	324	FWH-1000B
2415	110 (150)	394	FWH-1000B

*1 Yaskawa recommends a fuse with a large rated current for applications with repeated loads.

■ **Three-Phase 400 V Class**

Table 3.21 Factory-Recommended Branch Circuit Protection: 400 V Class (ND)

Drive Model	Maximum Applicable Motor Output kW (HP) Input Voltage < 460 V	Maximum Applicable Motor Output kW (HP) Input Voltage ≥ 460 V	Input Current Rating A	Semiconductor Protection Fuse Rated Current Manufacturer: EATON/ Bussmann
4002	0.75 (1)	0.75 (1)	2.5	FWH-50B
4004	1.5 (2)	1.5 (2)	4.7	FWH-50B
4005	2.2 (3)	2.2 (3)	6.7	FWH-50B
4007	3.0 (4)	3.0 (4)	8.9	FWH-60B
4009	4.0 (5)	3.7 (5)	11.7	FWH-60B
4012	5.5 (7.5)	5.5 (7.5)	15.8	FWH-60B
4018	7.5 (10)	7.5 (10)	21.2	FWH-80B
4023	11 (15)	11 (15)	30.6	FWH-90B
4031	15 (20)	15 (20)	41.3	FWH-150B
4038	18.5 (25)	18.5 (25)	50.5	FWH-200B
4044	22 (30)	22 (30)	59.7	FWH-200B
4060	30 (40)	30 (40)	58.3	FWH-225A
4075	37 (50)	37 (50)	71.5	FWH-250A
4089	45 (60)	45 (60)	86.5	FWH-275A

Drive Model	Maximum Applicable Motor Output kW (HP) Input Voltage < 460 V	Maximum Applicable Motor Output kW (HP) Input Voltage ≥ 460 V	Input Current Rating A	Semiconductor Protection Fuse Manufacturer: EATON/ Bussmann
4103	55 (75)	55 (75)	105	FWH-275A
4140	75 (100)	75 (100)	142	FWH-300A
4168	90 (125)	90 (125)	170	FWH-325A FWH-400A */
4208	110 (150)	110 (150)	207	FWH-500A
4250	132 (175)	150 (200)	248	FWH-600A
4296	160 (200)	185 (250)	300	FWH-700A
4371	200 (250)	220 (300)	373	FWH-800A
4389	220 (300)	260 (350)	410	FWH-1000B
4453	250 (335)	300 (400)	465	FWH-1200B
4568	315 (400)	335 (450)	584	FWH-1200B
4675	355 (450)	370 (500)	657	FWH-1400A
4810	450 (603)	525 (700)	879	FWH-1200B
4930	500 (670)	600 (800)	922	FWH-1200B
4H11	560 (751)	675 (900)	1091	FWH-1600A
4H12	630 (845)	750 (1000)	1158	FWH-1600A

*1 Yaskawa recommends a fuse with a large rated current for applications with repeated loads.

Table 3.22 Factory-Recommended Branch Circuit Protection: 400 V Class (HD)

Drive Model	Maximum Applicable Motor Output kW (HP) Input Voltage < 460 V	Maximum Applicable Motor Output kW (HP) Input Voltage ≥ 460 V	Input Current Rating A	Semiconductor Protection Fuse Manufacturer: EATON/ Bussmann
4002	0.55 (0.75)	0.55 (0.75)	1.9	FWH-50B
4004	1.1 (1.5)	0.75 (1)	3.5	FWH-50B
4005	1.5 (2)	1.5 (2)	4.7	FWH-50B
4007	2.2 (3)	2.2 (3)	6.7	FWH-60B
4009	3 (4)	3 (4)	8.9	FWH-60B
4012	4.0 (5)	3.7 (5)	11.7	FWH-60B
4018	5.5 (7.5)	5.5 (7.5)	15.8	FWH-80B
4023	7.5 (10)	7.5 (10)	21.2	FWH-90B
4031	11 (15)	11 (15)	30.6	FWH-150B
4038	15 (20)	15 (20)	41.3	FWH-200B
4044	18.5 (25)	18.5 (25)	50.5	FWH-200B
4060	22 (30)	22 (30)	43.1	FWH-225A
4075	30 (40)	30 (40)	58.3	FWH-250A
4089	37 (50)	37 (50)	71.5	FWH-275A
4103	45 (60)	45 (60)	86.5	FWH-275A
4140	55 (75)	55 (75)	105	FWH-300A
4168	75 (100)	75 (100)	142	FWH-325A FWH-400A */
4208	90 (125)	90 (125)	170	FWH-500A
4250	110 (150)	110 (150)	207	FWH-600A
4296	132 (175)	150 (200)	248	FWH-700A
4371	160 (200)	185 (250)	300	FWH-800A
4389	200 (250)	220 (300)	373	FWH-1000B
4453	220 (300)	260 (350)	410	FWH-1200B
4568	250 (335)	300 (400)	465	FWH-1200B

Electrical Installation

3.15 Protect the Drive during Failures

Drive Model	Maximum Applicable Motor Output kW (HP) Input Voltage < 460 V	Maximum Applicable Motor Output kW (HP) Input Voltage ≥ 460 V	Input Current Rating A	Semiconductor Protection Fuse Manufacturer: EATON/ Bussmann
4675	315 (400)	335 (450)	584	FWH-1400A
4810	400 (536)	450 (600)	783	FWH-1200B
4930	450 (603)	525 (700)	830	FWH-1200B
4H11	500 (670)	600 (800)	976	FWH-1600A
4H12	560 (751)	675 (900)	1031	FWH-1600A

*1 Yaskawa recommends a fuse with a large rated current for applications with repeated loads.

■ 6-Phase/12-Pulse 400 V Class

Table 3.23 Factory-Recommended Branch Circuit Protection: 6-Phase/12-Pulse 400 V Class

Drive Model	Semiconductor Protection Fuse Manufacturer: EATON/Bussmann	Drive Model	Semiconductor Protection Fuse Manufacturer: EATON/Bussmann
4810	FWH-1000B	4H11	FWH-1200B
4930	FWH-1000B	4H12	FWH-1200B

3.16 Wiring Checklist

Checked	No.	Item to Check
	9	Make sure that you isolate the control circuit wiring from main circuit wiring in the control panel or in a duct.
	10	Make sure that control circuit wiring is not longer than 50 m (164 ft).
	11	Make sure that Safe Disable input wiring is not longer than 30 m (98 ft).

3.17 Motor Application Precautions

◆ Precautions for Existing Standard Motors

■ Low-Speed Range

When a drive operates a standard motor, it will lose more power compared to operating the motor with a commercial power supply. In the low speed range, the temperature of the motor increases quickly because the motor cannot decrease its temperature when the speed decreases. In these conditions, decrease the load torque of the motor in the low-speed range. Figure 3.97 shows the permitted load characteristics for a Yaskawa standard motor. When 100% continuous torque is necessary at low speeds, use a motor designed to operate with a drive.

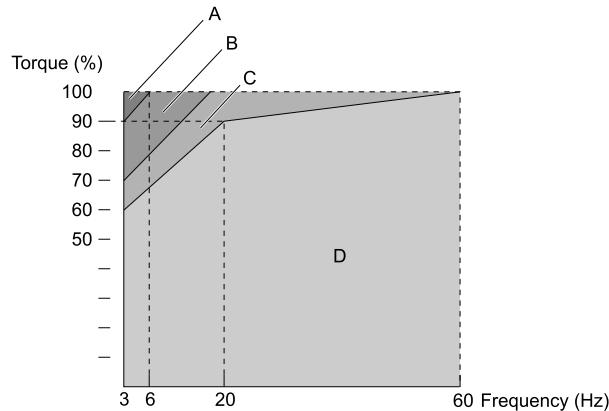

A - 25% ED (or 15 min)

B - 40% ED (or 20 min)

C - 60% ED (or 40 min)

D - Continuous operation

Figure 3.97 Permitted Load Characteristics for a Yaskawa Standard Motors

■ Insulation Withstand Voltage

Consider motor voltage tolerance levels and motor insulation in applications with an input voltage of over 440 V or particularly long wiring distances. Use an insulated drive motor.

NOTICE: Use an inverter-duty motor or vector-duty motor with reinforced insulation and windings applicable for use with an AC drive. If the motor does not have the correct insulation, it can cause a short circuit or ground fault from insulation deterioration.

■ High-Speed Operation

If you operate a motor more than its rated speed, you can have problems with the motor bearing durability and dynamic balance of the machine. Contact the motor or machine manufacturer.

■ Torque Characteristics

When you operate a motor with a drive, the torque characteristics are different than when you operate the motor directly from line power. Make sure that you know about the load torque characteristics for your application.

■ Vibration

Vibrations could occur in the these conditions:

- Resonance with the natural frequency of machinery
Use caution if you add a variable-speed drive to applications that operate the motor from line power at a constant speed. If resonance occurs, install shock-absorbing rubber around the base of the motor and enable the Jump frequency control.
- The motor is not balanced
Use caution if the motor speed is more than the rated motor speed.
- Subsynchronous resonance
Subsynchronous resonance can occur with long motor shafts and in applications such as turbines, blowers, and fans with high inertia loads.
Use Closed Loop Vector Control when these applications have subsynchronous resonance problems.

■ Audible Noise

The audible noise of the motor changes when the carrier frequency setting changes. When you use a high carrier frequency, audible noise from the motor is equivalent to the motor noise generated when you operate from line power. If you operate at speeds that are more than the rated rotation speed, the unwanted motor noise increases.

◆ Precaution When You Use IE3 Premium Efficiency Motors

IE3 motors have different motor characteristics from IE1 and other motors. Set the parameters as specified by the motor characteristics. If you have a momentary power loss, and the drive detects *oC* [*Overcurrent*] or *ov* [*Overvoltage*] during speed search after it restores power, set these parameters:

- *b3-03* [*Speed Search Deceleration Time*] = default value × 2
 - *L2-03* [*Minimum Baseblock Time*] = default value × 2
 - *L2-04* [*Powerloss V/f Recovery Ramp Time*] = default value × 2
-

◆ Precautions for PM Motors

- Contact Yaskawa or your nearest sales representative to use a non-Yaskawa PM motor.
- You cannot operate a PM motor from a commercial power supply. If you must operate from a commercial power supply, use an induction motor.
- You cannot operate more than one PM motor from one drive. Use an induction motor and a variable-speed control drive.
- In Open Loop Vector Control for PM motor (OLV/PM), the motor can operate in the reverse direction for 1/2 turn (electrical angle) at start up.
- The quantity of generated starting torque changes when the control method and motor type change. Verify the starting torque, permitted load characteristics, impact load tolerance, and speed control range before you set up the motor with the drive. Contact Yaskawa or your nearest sales representative to use a motor that does not meet these specifications.
- In OLV/PM control, braking torque is always 125% or less when operating between 20% and 100% speed. A braking resistor unit will not change the value. Braking torque is 50% or less when operating at 20% speed or less.
- In OLV/PM control, the allowable load inertia moment is approximately 50 times higher than the motor inertia moment. Use Closed Loop Vector Control for PM motors for applications with a larger inertia moment.
- When you use a holding brake in OLV/PM control, release the brake before you start the motor. Failure to set the correct timing can cause a decrease in speed. Do not use these configurations in applications with heavy loads, for example conveyors or elevators.
- To restart a coasting motor that is rotating faster than 200 Hz in V/f Control, first use the Short Circuit Braking function to stop the motor. A special braking resistor unit is necessary for Short Circuit Braking. Contact Yaskawa or your nearest sales representative for more information.
To restart a coasting motor that is rotating slower than 200 Hz, use the Speed Search function.
If the motor cable is long, use Short Circuit Braking to stop the motor.

Note:

The Short Circuit Braking function uses the drive to forcefully cause a short across the motor wires to stop the motor before it has time to coast to a stop.

- You can also use EZ Open Loop Vector Control (EZOLV) to operate synchronous reluctance motors (SynRM). Contact Yaskawa or your nearest sales representative for more information.
 - After you replace a failed PM motor encoder, make sure that the motor can rotate and do Z Pulse Offset Tuning or PM Rotational Auto-Tuning.
 - If *oC* [*Overcurrent*], *STPo* [*Motor Step-Out Detected*], or *LSo* [*Low Speed Motor Step-Out*] occur during restart, try Speed Search again and use the Short Circuit Braking function when you start to adjust the motor.
-

◆ Precautions for Specialized Motors

■ Pole Change Motors

The rated current of pole change motors is different than standard motors. Check the maximum current of the motor before you select a drive. Always stop the motor before you switch between the number of motor poles. If you change the number of poles while the motor is rotating, the overvoltage from regeneration or the overcurrent protection circuitry will make the motor coast to stop.

■ Submersible Motors

The rated current of a submersible motor is more than the rated current of a standard motor. Use a sufficiently large motor cable that will not let voltage drop decrease the maximum torque level.

■ Explosion-Proof Motors

You must test the motor and the drive together for explosion-proof certification. You must also test existing installations of explosion-proof motors. The drive is not designed for explosion-proof areas. Install the drive in a safe location.

The encoder used with pressure-resistant explosion-proof motors is intrinsically safe. When wiring between the drive and encoder, always connect through a specialized pulse coupler.

■ Geared Motors

The continuous speed range is different for different lubricating methods and manufacturers. For oil lubrication, continuous operation in the low-speed range can cause burnout. Contact the manufacturer for more information about applications where operating at more than the rated frequency is necessary.

■ Single-Phase Motors

Variable speed drives are not designed to operate with single-phase motors. The drive is for use with three-phase motors only. If you use capacitors to start the motor, it can cause a high frequency current to flow to the capacitors and can damage the capacitors. A split-phase start or a repulsion start can burn out the starter coils because the internal centrifugal switch is not activated.

■ Motors with Brakes

If you use a drive to operate a motor that has a brake connected to the output side, low voltage levels can cause the brake to possibly not release at start. Use a motor with a brake that has a dedicated source of power for the brake. Connect the brake power supply to the power supply side of the drive. Motors with built-in brakes make noise when operating at low speeds.

◆ Notes on the Power Transmission Mechanism

For power transmission machinery that uses oil to lubricate gearboxes, transmissions, or reduction gears, make sure that you use precaution if you operate the machinery continuously at low speed. Oil does not lubricate the system as well at low speeds. If you operate at frequencies higher than the rated frequency, it can cause problems with the power transmission mechanism. These problems include audible noise, decreased service life, and decreased durability.

Startup Procedure and Test Run

4.1	Section Safety	148
4.2	Keypad Components and Functions.....	149
4.3	LED Status Ring.....	155
4.4	Start-up Procedures	157
4.5	Items to Check before Starting Up the Drive.....	161
4.6	Keypad Operation	163
4.7	Automatic Parameter Settings Optimized for Specific Applications (Application Presets).....	204
4.8	Auto-Tuning	206
4.9	Test Run	215
4.10	Fine Tuning during Test Runs (Adjust the Control Function).....	217
4.11	Test Run Checklist	224

4.1 Section Safety

DANGER

Electrical Shock Hazard

Do not examine, connect, or disconnect wiring on an energized drive. Before servicing, disconnect all power to the equipment and wait for the time specified on the warning label at a minimum. The internal capacitor stays charged after the drive is de-energized. The charge indicator LED extinguishes when the DC bus voltage decreases below 50 Vdc. When all indicators are OFF, remove the covers before measuring for dangerous voltages to make sure that the drive is safe.

If you do work on the drive when it is energized, it will cause serious injury or death from electrical shock.

WARNING

Electrical Shock Hazard

Do not operate the drive when covers are missing. Replace covers and shields before you operate the drive. Use the drive only as specified by the instructions.

Some figures in this section include drives without covers or safety shields to more clearly show the inside of the drive. If covers or safety shields are missing from the drive, it can cause serious injury or death.

Do not remove covers or touch circuit boards while the drive is energized.

If you touch the internal components of an energized drive, it can cause serious injury or death.

Sudden Movement Hazard

When you use a mechanical holding brake with the drive in a lifting application, you must close the brake if an input terminal triggers the Baseblock command to stop drive output.

If you enter the baseblock command, the motor will suddenly coast and the load will slip, which can cause serious injury or death.

When you use the drive in a lifting application, you must also install external safety circuitry. The drive does not have protection against accidental load drops in lifting applications. Install electrical and/or mechanical safety circuit mechanisms that are isolated from the drive circuitry.

If you do not use external safety circuitry, the drive could drop the load and cause serious injury or death.

NOTICE

Sudden Movement Hazard

Deactivate the Run command before you switch from Programming Mode to Drive Mode.

If you switch from Programming Mode to Drive Mode and there is an active Run command, the motor will rotate and the equipment can suddenly start.

4.2 Keypad Components and Functions

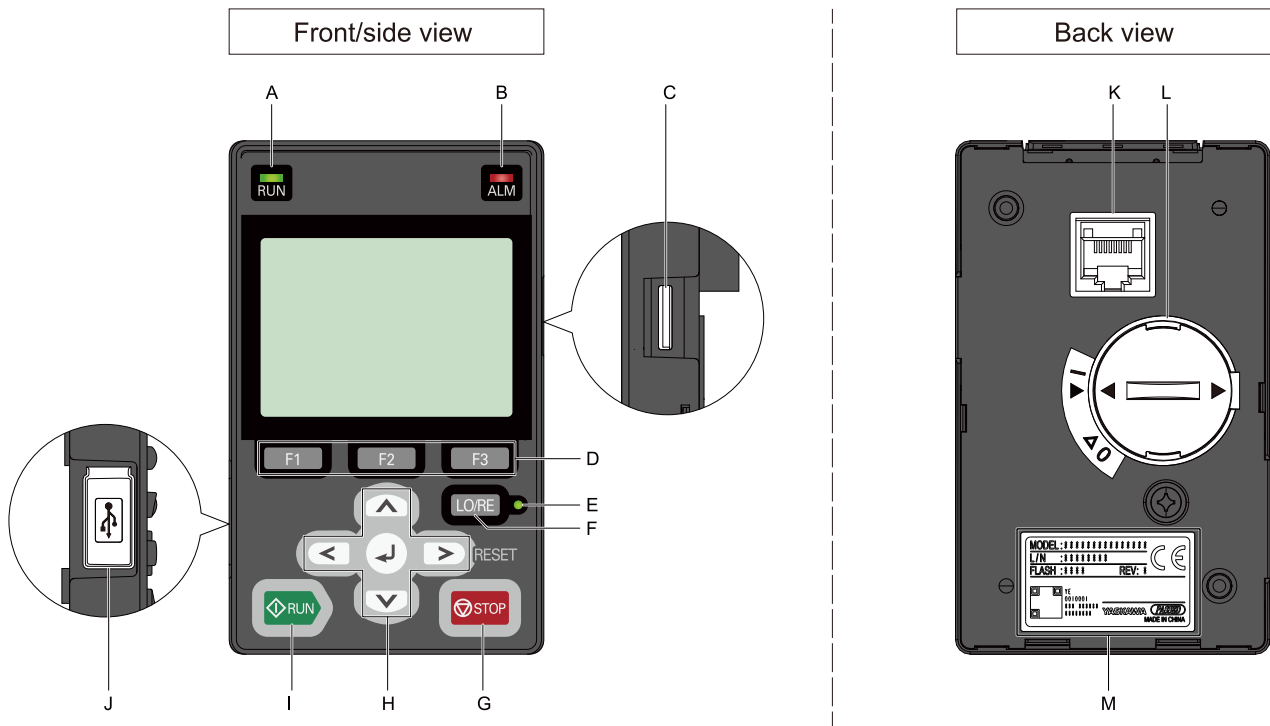





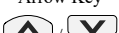





Figure 4.1 Keypad

Table 4.1 Keypad Components and Functions

Symbol	Name	Function
A	RUN LED 	<p>Illuminates to show that the drive is operating the motor. The LED turns OFF when the drive stops. Flashes to show that:</p> <ul style="list-style-type: none"> The drive is decelerating to stop. The drive received a Run command with a frequency reference of 0 Hz, but the drive is not set for zero speed control. <p>Flashes quickly to show that:</p> <ul style="list-style-type: none"> The drive received a Run command from the MFDI terminals and is switching to REMOTE Mode while the drive is in LOCAL Mode. The drive received a Run command from the MFDI terminals when the drive is not in Drive Mode. The drive received a Fast Stop command. The safety function shut off the drive output. <ul style="list-style-type: none"> You pushed on the keypad while the drive is operating in REMOTE Mode. The drive is energized with an active Run command and <i>b1-17 = 0</i> [Run Command at Power Up = Disregard Existing RUN Command].
B	ALM LED 	<p>Illuminates when the drive detects a fault. Flashes when the drive detects:</p> <ul style="list-style-type: none"> Alarm Operation Errors A fault or alarm during Auto-Tuning <p>The light turns off during regular drive operation. There are no alarms or faults.</p>
C	microSD Card Slot	The insertion point for a microSD card.
D	Function Keys (F1, F2, F3) 	The menu shown on the keypad sets the functions for function keys. The name of each function is in the lower half of the display window.
E	LO/RE LED 	<p>Illuminated: The keypad controls the Run command (LOCAL Mode). OFF: The control circuit terminal or serial transmission device controls the Run command (REMOTE Mode).</p> <p>Note:</p> <ul style="list-style-type: none"> LOCAL: Use the keypad to operate the drive. Use the keypad to enter Run/Stop commands and the frequency reference command. REMOTE: Use the control circuit terminals or serial transmission to operate the drive. Use the frequency reference source entered in <i>b1-01</i> and the Run command source selected in <i>b1-02</i>.

4.2 Keypad Components and Functions

Symbol	Name	Function
F	LO/RE Selection Key 	Switches drive control for the Run command and frequency reference BETWEEN the keypad (LOCAL) and an external source (REMOTE). Note: • The LOCAL/REMOTE Selection Key continuously stays enabled after the drive stops in Drive Mode. If the application must not switch from REMOTE to LOCAL because it will have a negative effect on system performance, set $o2-01 = 0$ [LO/RE Key Function Selection = Disabled] to disable  • The drive will not switch between LOCAL and REMOTE when it is receiving a Run command from an external source.
G	STOP Key 	Stops drive operation. Note: Push  to stop the motor. This will also apply when a Run command (REMOTE Mode) is active at an external Run command source. To disable  priority, set $o2-02 = 0$ [STOP Key Function Selection = Disabled].
H	Left Arrow Key 	<ul style="list-style-type: none"> Moves the cursor to the left. Goes back to the previous screen.
	Up Arrow Key/Down Arrow Key 	<ul style="list-style-type: none"> Scrolls up or down to show the next item or the previous item. Selects parameter numbers, and increments or decrements setting values.
	Right Arrow Key (RESET) 	<ul style="list-style-type: none"> Moves the cursor to the right. Continues to the next screen. Resets the drive to clear a fault.
	ENTER Key 	<ul style="list-style-type: none"> Enters parameter values and settings. Selects menu items to move between keypad displays. Selects each mode, parameter, and set value.
I	RUN Key 	Starts the drive in LOCAL Mode. Starts the operation in Auto-Tuning Mode. Note: Before you use the keypad to operate the motor, push  on the keypad to set the drive to LOCAL Mode.
J	USB Terminal	For factory adjustment
K	RJ-45 Connector	Connects to the drive using an RJ-45 8-pin straight through UTP CAT5e extension cable or keypad connector.
L	Clock Battery Cover	Remove this cover to install or replace the clock battery. Note: You must supply the clock battery ^{*1} . It is not included with the keypad.
M	Nameplate	Shows the model number of the keypad and other information Note: • "REV" identifies the hardware and software version of the keypad. • "FLASH" identifies the version of the flash memory.

*1 Refer to [Replace the Keypad Battery on page 447](#) for information about the correct clock battery and the installation procedure.

WARNING! Sudden Movement Hazard. If you change the control source when $b1-07 = 1$ [LOCAL/REMOTE Run Selection = Accept Existing RUN Command], the drive can start suddenly. Before you change the control source, remove all personnel from the area around the drive, motor, and load. Sudden starts can cause serious injury or death.

◆ LCD Display

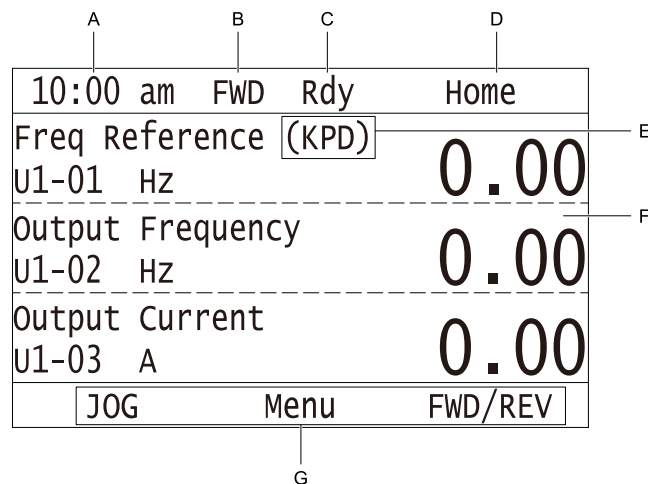







Figure 4.2 LCD Display Indications

Table 4.2 LCD Display Indications and Meanings

Symbol	Name	Description
A	Time display area	Shows the current time. Set the time on the default settings screen. Note: The time display flashes when you use the data log function.
B	Forward run/Reverse indication	Shows direction of motor rotation. • FWD: Shown when set to Forward run. • REV: Shown when set to Reverse run. Note: In DriveWorksEZ operation, FWD or REV flash.
C	Ready	The screen will show Rdy when the drive is ready for operation or when the drive is running.
D	Mode display area	Shows the name of the current mode or screen.
E	Frequency reference source indicator	Shows the current frequency reference source. • KPD: keypad • AI: analog input terminal (terminals A1 to A3) • COM: MEMOBUS/Modbus communications • OPT: option card • RP: pulse train input terminal (terminal RP)
F	Data display area	Shows parameter values, monitor values, and details of the results of operations.
G	Function keys 1 to 3 (F1 to F3)	The function names shown in this area will change when the selected screen changes. Push one of the function keys  to  on the keypad to do the function.

◆ **Indicator LEDs and Drive Status**

LED	Display	Drive Status
RUN LED 	Illuminated	The drive is operating the motor.
	Flashing	<ul style="list-style-type: none"> The drive is decelerating to stop. The drive received a Run command with a frequency reference of 0 Hz, but the drive is not set for zero speed control. The drive received a DC Injection Braking command.
	Flashing Quickly	<ul style="list-style-type: none"> The drive received a Run command from the MFDI terminals and is switching to REMOTE Mode while the drive is in LOCAL Mode. The drive received a Run command from an external source and the drive is not in Drive Ready (READY) condition. The drive received a Fast Stop command. The safety function shut off the drive output. You pushed  on the keypad while the drive is operating in REMOTE Mode. The drive is energized with an active Run command and $b1-17 = 0$ [Run Command at Power Up = Disregard Existing RUN Command]. When $b1-03 = 3$ [Stopping Method Selection = Coast to Stop with Timer], the Run command is disabled then enabled during the Run wait time. The drive received a DC Injection Braking command. The voltage of the main circuit power supply decreased, and the 24 V power supply is supplying power only the the drive.
	OFF	The motor is stopped.
ALM LED 	Illuminated	The drive detects a fault.
	Flashing	The drive detected one of the following: <ul style="list-style-type: none"> An alarm An oPE parameter setting error A fault or error during Auto-Tuning Note: The digital characters displayed on the keypad will also flash.
	OFF	There are no drive faults or alarms.
LO/RE LED 	Illuminated	The keypad controls the Run command (LOCAL Mode).
	OFF	The control circuit terminal or serial transmission device controls the Run command (REMOTE Mode).

Startup Procedure and Test Run

■ **LED Flashing Statuses**

Refer to [Figure 4.3](#) for information about the differences between flashing and “flashing quickly”.

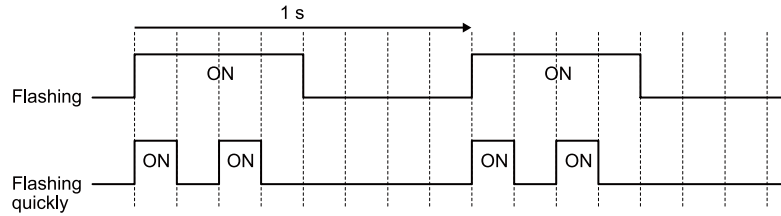

Figure 4.3 LED Flashing Statuses

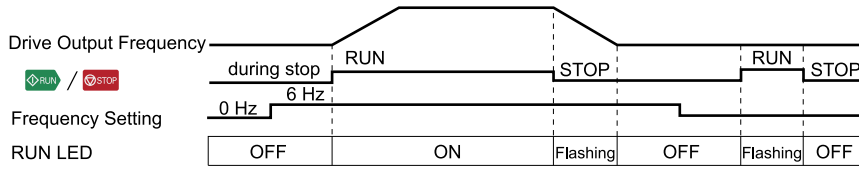
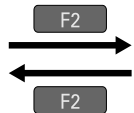

Figure 4.4 Relation between RUN indicator and Drive Operation

◆ Keypad Mode and Menu Displays

10:00 am FWD Rdy Home	
Freq Reference (AI)	0.00
U1-01 Hz	0.00
Output Frequency	0.00
U1-02 Hz	0.00
Output Current	0.00
U1-03 A	0.00
Menu	

HOME



10:00 am FWD Rdy Menu
Monitors
Parameters
User Custom Parameters
Parameter Backup/Restore
Modified Param / Fault Log
Auto-Tuning
Home

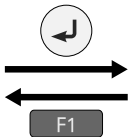

10:00 am FWD Rdy Monitor
Standard Monitor
Custom Monitor
Bar Graph
Analog Gauge
Trend Plot
Back Home

Drive Mode

10:00 am FWD Menu
Monitors
Parameters
User Custom Parameters
Parameter Backup/Restore
Modified Param / Fault Log
Auto-Tuning
Home

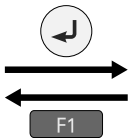

10:00 am FWD Parameters
Initialization Parameters
b Application
C Tuning
d References
E Motor Parameters
F Options
Back Home

10:00 am FWD Menu
Monitors
Parameters
User Custom Parameters
Parameter Backup/Restore
Modified Param / Fault Log
Auto-Tuning
Home

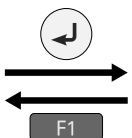

10:00 am FWD Parameters
Application Preset
A1-06 0 (0)
Control Method Selection
A1-02 2 (2)
Frequency Reference Selection 1
b1-01 1 (1)
Back Home

10:00 am FWD Menu
Monitors
Parameters
User Custom Parameters
Parameter Backup/Restore
Modified Param / Fault Log
Auto-Tuning
Home

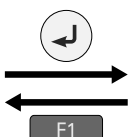

10:00 am FWD Backup
Select Items to Backup/Restore
Standard Parameters
Back Home

10:00 am FWD Menu
Monitors
Parameters
User Custom Parameters
Parameter Backup/Restore
Modified Param / Fault Log
Auto-Tuning
Home

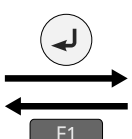

10:00 am FWD History
Modified Parameters
Fault Log
Back Home

10:00 am FWD Menu
Parameters
User Custom Parameters
Parameter Backup/Restore
Modified Param / Fault Log
Auto-Tuning
Initial Setup
Home

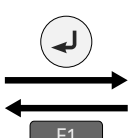

10:00 am FWD Auto Tuning
Select Auto-Tuning mode
Motor Parameter Tuning
Back Home

10:00 am FWD Menu
User Custom Parameters
Parameter Backup/Restore
Modified Param / Fault Log
Auto-Tuning
Initial Setup
Diagnostic Tools
Home

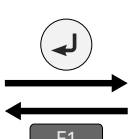

10:00 am FWD Init Setup
Language Selection
Set Date/Time
Setup Wizard
Show Initial Setup Screen
Back Home

10:00 am FWD Menu
User Custom Parameters
Parameter Backup/Restore
Modified Param / Fault Log
Auto-Tuning
Initial Setup
Diagnostic Tools
Home

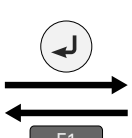

10:00 am FWD Tools
Data Logger
Backlight
Drive Information
Back Home Setup

Programming Mode

Main Menu

Diagnostic Tools

Figure 4.5 Keypad Functions and Display Levels

Startup Procedure and Test Run

4.2 Keypad Components and Functions

Note:



- Energize the drive with factory defaults to show the Initial Setup screen. Push  [Home] to show the HOME screen.
–Select [No] from the [Show Initial Setup Screen] setting to not display the Initial Setup screen.
- Push  from the Home screen to show drive monitors.
- Push  to set *d1-01 [Reference 1]* when the Home screen shows *U1-01 [Frequency Reference]* in LOCAL Mode.
- The keypad will show [Rdy] when the drive is in Drive Mode. The drive is prepared to accept a Run command.
- Set *b1-08 [Run Command Select in PRG Mode]* to accept or reject a Run command from an external source while in Programming Mode.
–Set *b1-08 = 0 [Disregard RUN while Programming]* to reject the Run command from an external source while in Programming Mode (default).
–Set *b1-08 = 1 [Accept RUN while Programming]* to accept the Run command from an external source while in Programming Mode.
–Set *b1-08 = 2 [Allow Programming Only at Stop]* to prevent changes from Drive Mode to Programming Mode while the drive is operating.

Table 4.3 Drive Mode Screens and Functions

Mode	Keypad Screen	Function
Drive Mode	Monitors	Sets monitor items to display.
Programming Mode	Parameters	Changes parameter settings.
	User Custom Parameters	Shows the User Parameters.
	Parameter Backup/Restore	Saves parameters to the keypad as backup.
	Modified Parameters/Fault Log	Shows modified parameters and fault history.
	Auto-Tuning	Auto-Tunes the drive.
	Initial Setup Screen	Changes initial settings.
	Diagnostic Tools	Sets data logs and backlight.

4.3 LED Status Ring

The LED Status Ring on the drive cover shows the drive operating status.

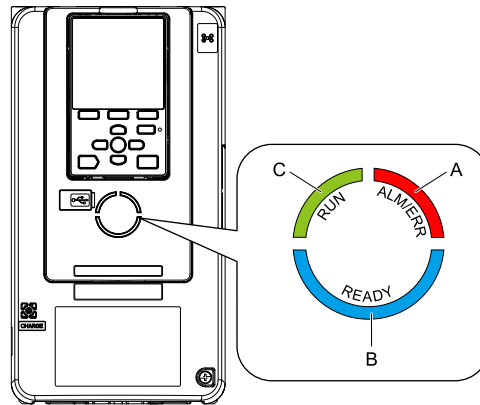

A - ALM/ERR
B - Ready

C - RUN

LED	Status	Description	
A	ALM/ERR	<ul style="list-style-type: none"> Illuminated: The drive detects a fault. Flashing ^{*1}: The drive detects: <ul style="list-style-type: none"> An alarm An oPE parameter setting error An Auto-Tuning error <p>Note: The LED will illuminate to identify a fault if the drive detects a fault and an alarm at the same time.</p> OFF: There are no drive faults or alarms. 	
	B	Ready	<ul style="list-style-type: none"> Illuminated: The drive is operating or is prepared for operation. Flashing ^{*1}: The drive is in <i>STo</i> [Safe Torque OFF] condition. Flashing Quickly ^{*1}: The voltage of the main circuit power supply dropped, and only the external 24 V power supply provides the power to the drive. OFF: <ul style="list-style-type: none"> The drive detects a fault. There is no fault and the drive received a Run command, but the drive cannot operate. For example, in Programming Mode or when  is flashing.
		C	RUN

*1 Refer to Figure 4.6 for the difference between “flashing” and “flashing quickly”.

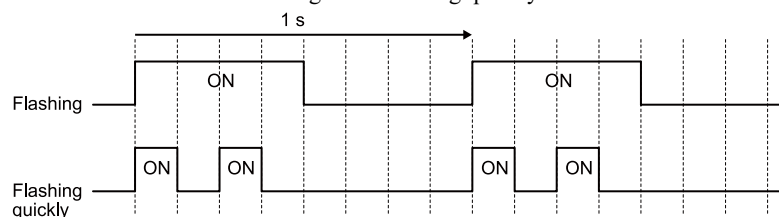

Figure 4.6 LED Flashing Statuses

4.3 LED Status Ring

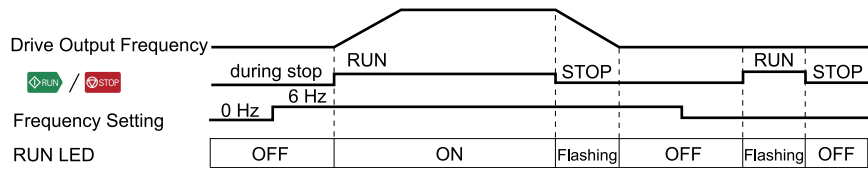

Figure 4.7 Relation between RUN LED and Drive Operation

4.4 Start-up Procedures

This section gives the basic steps necessary to start up the drive.

Use the flowcharts in this section to find the most applicable start-up method for your application.

This section gives information about only the most basic settings.

Note:

Refer to the *A1-06* section to use an Application Preset to set up the drive.

◆ Flowchart A: Connect and Run the Motor with Minimum Setting Changes

Flowchart A shows a basic start-up sequence to connect and run a motor with a minimum of setting changes. Settings can change when the application changes.

Use the drive default parameter settings for basic applications where high precision is not necessary.

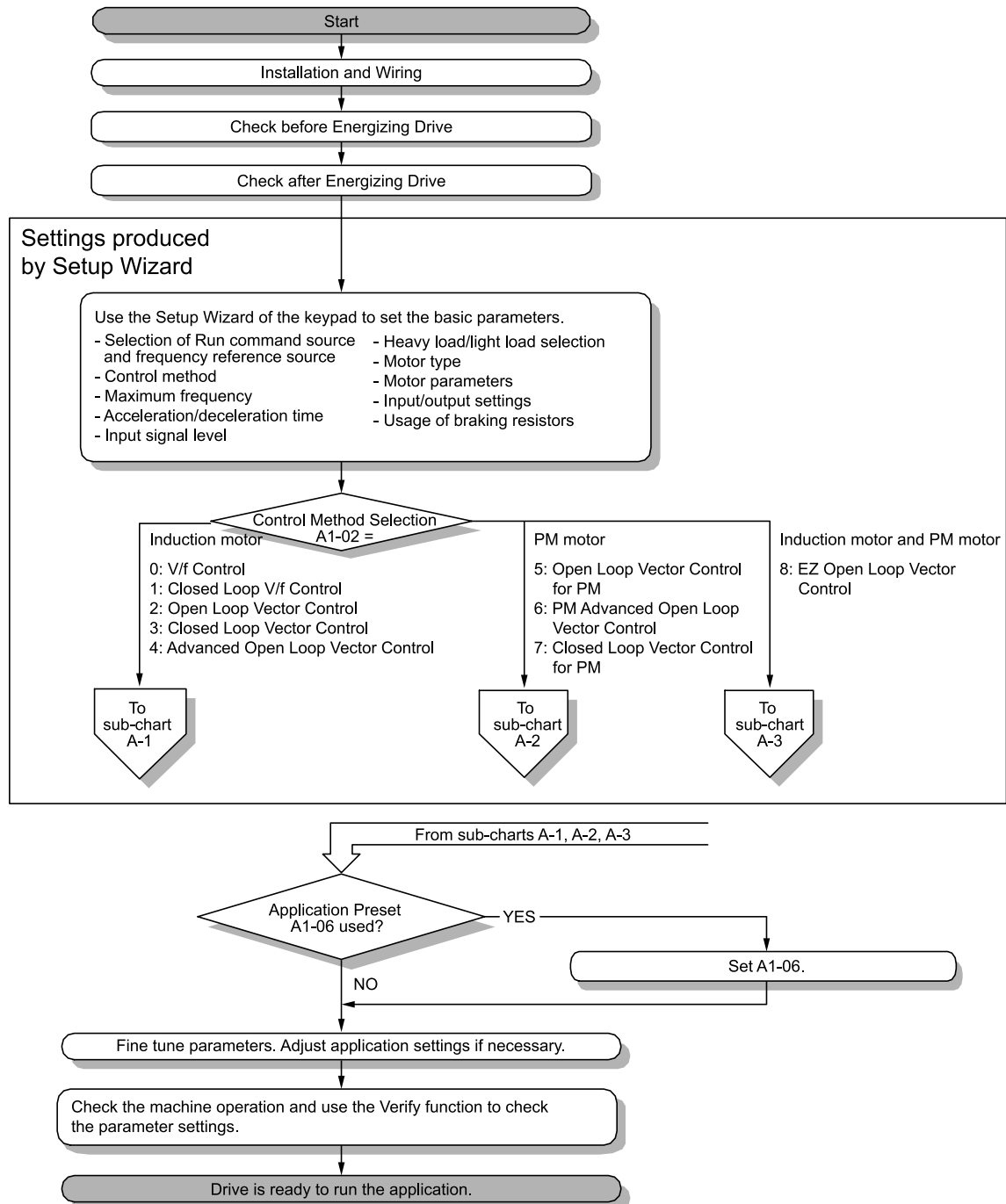

Figure 4.8 Basic Steps before Startup

◆ Sub-Chart A-1: Induction Motor Auto-Tuning and Test Run Procedure

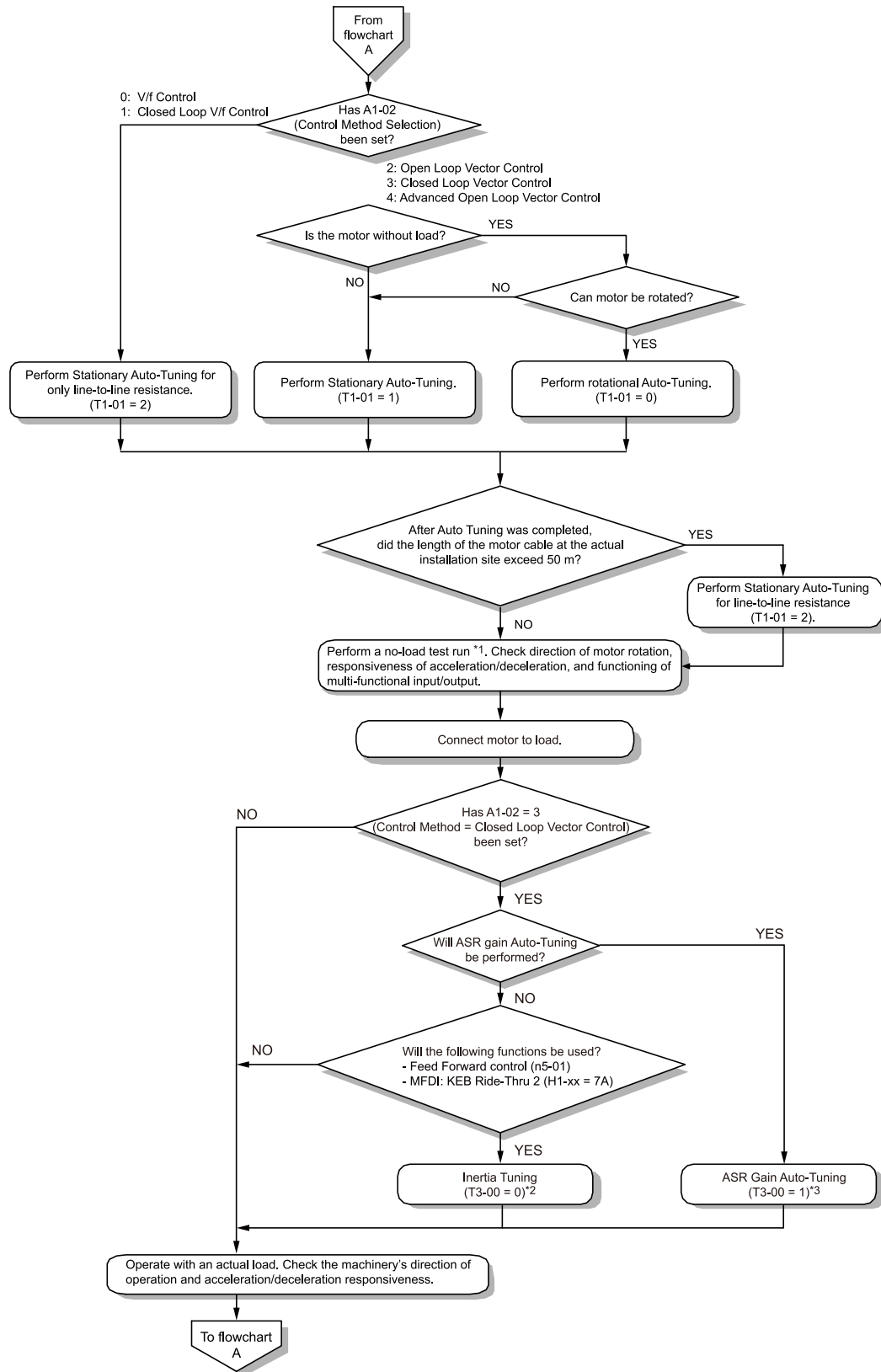

Figure 4.9 Induction Motor Auto-Tuning and Test Run Procedure

- *1 When A1-02 = 4 [Control Method Selection = AOLV], If you operate the drive at a frequency lower than n4-70 [Speed Command Comp @ Low Freq] (default setting: 1.00 Hz), the motor can rotate at a frequency about 1/2 of n4-70. When you do a test run, set E1-09 > 0 [Minimum Output Frequency > 0]. The recommended setting for E1-09 is 0.5 Hz.
- *2 Be sure to release the holding brake before doing Inertia Tuning.
- *3 In ASR Tuning, the drive will automatically tune Feed Forward control and KEB Ride-Thru 2 parameters.

◆ Sub-Chart A-2: PM Motor Auto-Tuning and Test Run Procedure

Sub-Chart A-2 gives the basic steps to start up the drive for a PM motor.

Note:

1. Although Auto-Tuning will set parameters for speed control with an encoder, set *F1-05 [PG 1 Rotation Selection]* before starting Auto-Tuning.
2. If you replace the encoder, do Z Pulse Offset Tuning.

WARNING! Crush Hazard. Test the system to make sure that the drive operates safely after you wire the drive and set parameters. If you do not test the system, it can cause damage to equipment or serious injury or death.

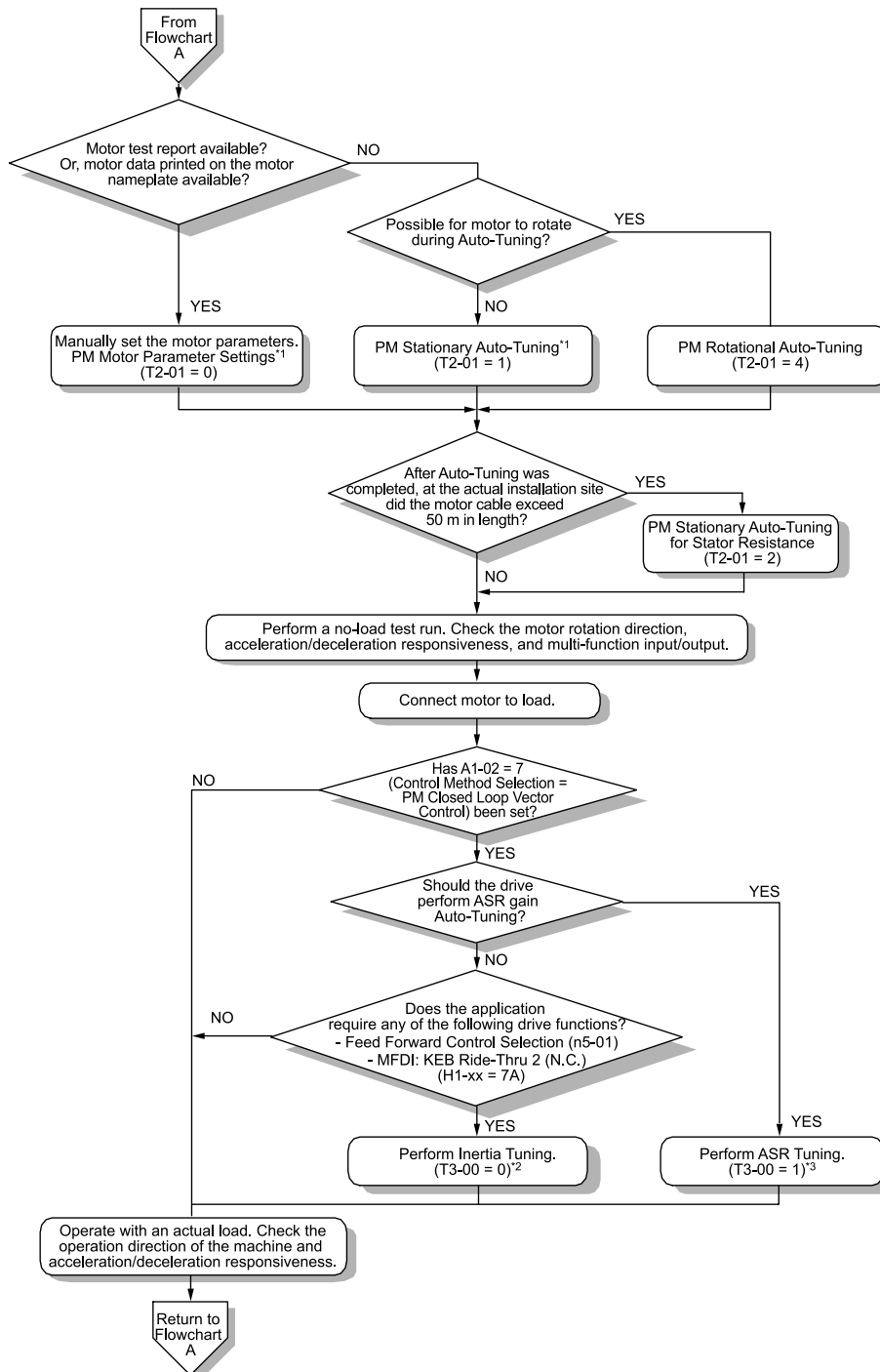

Figure 4.10 PM Motor Auto-Tuning and Test Run Procedure

- *1 For Yaskawa PM motors (SMRA-series, SSR1-series, or SST4-series), set *E5-01 [PM Motor Code Selection]*. For PM motors from a different manufacturer, set *E5-01 = FFFF*.
- *2 Be sure to release the holding brake before doing Inertia Tuning.
- *3 In ASR Tuning, the drive will automatically tune Feed Forward control and KEB Ride-Thru 2 parameters.

◆ **Subchart A-3: EZ Open Loop Vector Control Test Run Procedure**

Subchart A-3 gives the setup procedure to run a PM motor in EZ Open Loop Vector Control.

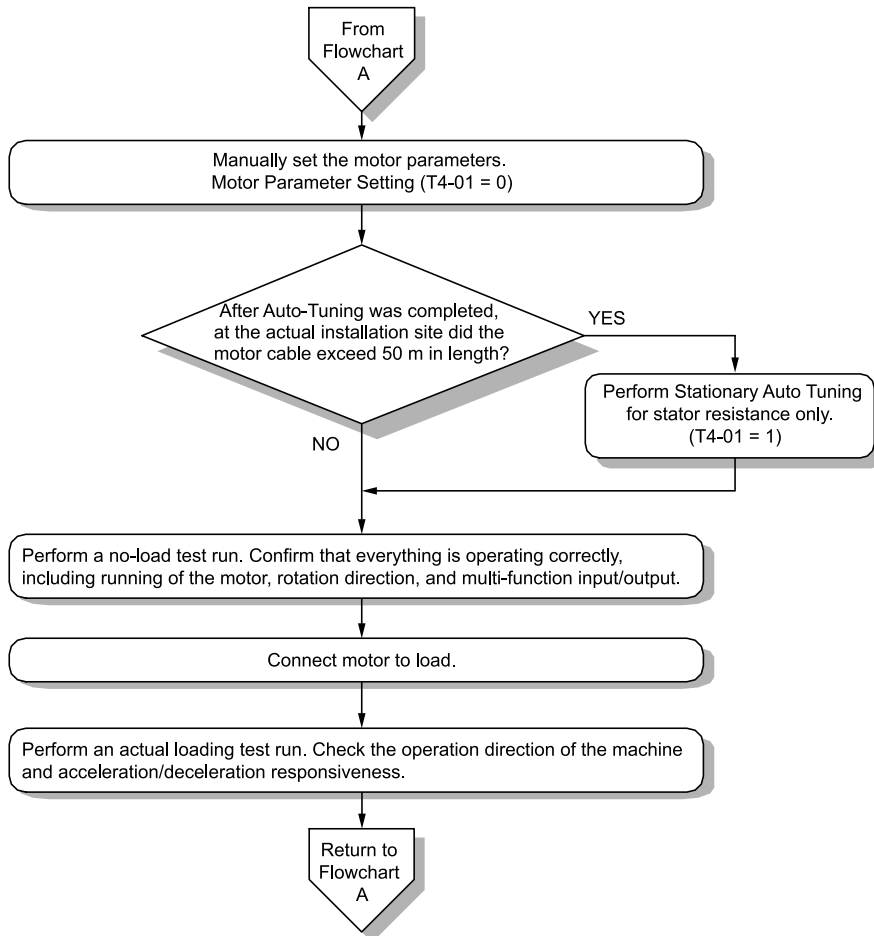

Figure 4.11 Procedure for Test Run of EZ Open Loop Vector Control Method

4.5 Items to Check before Starting Up the Drive

◆ Check before Energizing the Drive

Examine the items in [Table 4.4](#) before you energize the drive.

Table 4.4 Items to Check before Energizing the Drive

Items to Check	Description
Input Power Supply Voltage	The voltage of the input power supply must be: 200 V class: three-phase 200 Vac to 240 Vac 50/60 Hz, 270 Vdc to 340 Vdc 400 V class: three-phase 380 Vac to 480 Vac 50/60 Hz, 510 Vdc to 680 Vdc
	Correctly and safely wire power supply input terminals R/L1, S/L2, T/L3.
	Correctly ground the drive and motor.
Connection between Drive Output Terminals and Motor Terminals	Make sure that you connected drive output terminals U/T1, V/T2, and W/T3 in the correct sequence to agree with motor terminals U, V, and W without loosened screws.
Control Circuit Terminal Wiring	Make sure that you connected the drive control circuit terminals in the correct sequence to agree with devices and switches without loosened screws.
Control Circuit Terminal Status	Turn OFF the inputs from all devices and switches connected to the drive control circuit terminals.
Connection between Machinery and Motor	Disengage all couplings and belts that connect the motor and machinery.

◆ Check after You Energize the Drive

Check the items in [Table 4.5](#) after you energize the drive. The keypad display is different depending on drive status.

Table 4.5 Display Status after You Energize the Drive

Status	Display	Description
During Usual Operation	<p>Initial Setup Screen or</p> <p>HOME Screen</p>	<ul style="list-style-type: none"> The data display area will show the Initial Setup screen or the HOME screen Energize the drive with factory defaults to show the Initial Setup screen. Select [No] from the [Show Initial Setup Screen] settings to show the HOME screen without showing the Initial Setup screen.
When the Drive Detects a Fault		<p>The display is different for different faults. Refer to "Troubleshooting" to remove the cause of the fault. will illuminate.</p> <p>Note: If the screen shows a different screen, do these steps to show the fault content again:</p> <ol style="list-style-type: none"> Push from the HOME screen. Push (Home) from a different screen than the HOME screen.

◆ Make the Initial Settings

The keypad will show the Initial Setup screen when you energize the drive for the first time. You can set the date and time and the keypad language. The Setup Wizard prepares the drive for operation, including setting the basic

4.5 Items to Check before Starting Up the Drive

parameters and doing Auto-Tuning. Refer to *Set Parameters Using the Setup Wizard on page 189* for more information.

Note:

If the keypad does not show the Initial Setup screen, select [Initial Setup] from the Main Menu to show the Initial Setup screen.

1. Make the initial settings for each item.

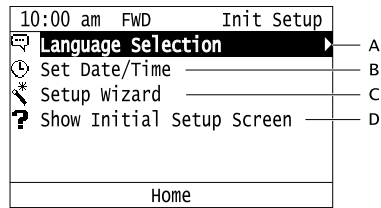

A - Language Selection

C - Setup Wizard

B - Set Date/Time

D - Show Initial Setup Screen

Note:

If you select [Yes] from the [Show Initial Setup Screen] setting, the keypad will show the Initial Setup screen each time the drive is energized.

If you select [NO], the keypad will not show the Initial Setup screen each time the drive is energized, starting with the next time.

2.  Push [Home].

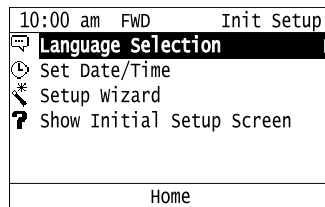

The display shows the HOME screen.

4.6 Keypad Operation

◆ Home Screen Display Selection



This section gives information about the content shown on the HOME screen and the functions that you can control from the HOME screen.

10:00 am	FWD Rdy	Home
Freq Reference(KPD)		0.00
U1-01 Hz		
Output Frequency		0.00
U1-02 Hz		
Output Current		0.00
U1-03 A		
JOG	Menu	FWD/REV





■ View Monitors Shown in Home Screen

This figure shows monitor data in the data display area of the HOME screen.



10:00 am	FWD Rdy	Home	
Freq Reference (KPD)		0.00	— Monitor
U1-01 Hz			
Output Frequency		0.00	
U1-02 Hz			
Output Current		0.00	
U1-03 A			
JOG	Menu	FWD/REV	

- To change what the screen shows, change the setting for *o1-40* [*Home Screen Display Selection*].
- When *o1-40* = 0 [*Custom Monitor*], and there is more than one screen, use  or  to switch between screens.

■ JOG Operation



Push  to illuminate . Push and hold  (JOG) to run the motor. Release  (JOG) to stop the motor.

■ Change Motor between Forward/Reverse Run



You can change the direction of motor rotation when operating the drive from the keypad. Push  to illuminate .

Push and hold  (FWD/REV) to toggle the direction of motor rotation between forward and reverse.







■ Show the Standard Monitor

Push  to show the standard monitor (*Ux-xx*). When you push  (Home), the keypad goes back to the home screen.

Note:

When a fault, minor fault, or an error occurs, push  to show the content of the fault. Push  again to show the standard monitor (*Ux-xx*).

■ Change the Frequency Reference Value

1. Push  to access the screen to change the frequency.
2. Push  or  to select the digit to change, then push  or  to change the value.
3. Push  to keep the changes.

4.6 Keypad Operation

Note:

The HOME screen must show *U1-01 [Frequency Reference]* or you must set the keypad as the Run command source (REMOTE) to use this function.

■ Show the Main Menu

Push **F2** to show the main menu. Push **F2** (Home) to go back to the HOME screen.

10:00 am	FWD	Rdy	Menu
Monitors			
Parameters			
User Custom Parameters			
Parameter Backup/Restore			
Modified Param / Fault Log			
Auto-Tuning			
Home			

◆ Show the Monitor

This section shows how to show the standard monitors (*Ux-xx*).

1. Push **F2** (Home) to show the HOME screen.

Note:

• When the drive is in HOME Mode, the screen shows [Home] in the upper right-hand corner of the screen.

• If [Home] is not shown on **F2**, push **F1** (Back) to show [Home] on **F2**.

2. Push **F2** (Menu).



10:00 am	FWD	Rdy	Home
Freq Reference (AI)			
U1-01	Hz		0.00
Output Frequency			
U1-02	Hz		0.00
Output Current			
U1-03	A		0.00
Menu			

3. Push  or  to select [Monitors], then push .

10:00 am	FWD	Rdy	Menu
Monitors			
Parameters			
User Custom Parameters			
Parameter Backup/Restore			
Modified Param / Fault Log			
Auto-Tuning			
Home			

4. Push  or  to select [Standard Monitor], then push .

10:00 am	FWD	Rdy	Monitor
Standard Monitor			
Custom Monitor			
Bar Graph			
Analog Gauge			
Trend Plot			
Back		Home	

5. Push  or  to select monitor group, then push .

10:00 am	FWD	Rdy	Monitor
U1 Operation Status Monitors			
U2 Fault Trace			
U3 Fault History			
U4 Maintenance Monitors			
U5 PID Monitors			
U6 Operation Status Monitors			
Back		Home	

6. Push  or  to change the monitor number to show the monitor item.

Note:

Push  to go back to the previous page.

10:00 am	FWD	Rdy	Monitor
Terminal A1 Input Lv			0.0
U1-13 %			0.0
Terminal A2 Input Lv			0.0
U1-14 %			0.0
Terminal A3 Input Lv			0.0
U1-15 %			0.0
Home			

◆ Set Custom Monitors

You can select and register a maximum of 12 monitoring items to regularly show on the keypad. This procedure shows how to set the motor speed to [Custom Monitor 1].

1. Push **F2** (Home) to show the HOME screen.

Note:

- The keypad will show [Home] in the top right corner when the HOME screen is active.
- If the keypad does not show [Home] on **F2**, push **F1** (Back) to show [Home] on **F2**.

2. Push **F2** (Menu).

10:00 am	FWD	Rdy	Home
Freq Reference (AI)			0.00
U1-01 Hz			0.00
Output Frequency			0.00
U1-02 Hz			0.00
Output Current			0.00
U1-03 A			0.00
Menu			

3. Push **▲** or **▼** to select [Monitors], then push **↵**.

10:00 am	FWD	Rdy	Menu
Monitors			
Parameters			
User Custom Parameters			
Parameter Backup/Restore			
Modified Param / Fault Log			
Auto-Tuning			
Home			

4. Push **▲** or **▼** to select [Custom Monitor], then push **F3** (Setup).

10:00 am	FWD	Rdy	Monitor
Standard Monitor			
Custom Monitor			
Bar Graph			
Analog Gauge			
Trend Plot			
Back	Home	Setup	

5. Push **▲** or **▼** to select [Custom Monitor 1], then push **↵**.

10:00 am	FWD		Setup
Custom Monitor 1			
Custom Monitor 2			
Custom Monitor 3			
Custom Monitor 4			
Custom Monitor 5			
Custom Monitor 6			
Back	Home		

6. Push **▲** or **▼** to select the monitor number to register, then push **↵**.

Set the x-xx part of monitor Ux-xx. For example, to show monitor U1-05, set it to "105" as shown in this figure.

10:00 am FWD	Parameters
Custom Monitor 1	
U1-24	105
Motor Speed	
Default : 101	
Back	Default

The configuration procedure is complete.

◆ Show Custom Monitors

The procedure in this section shows how to show the registered custom monitors.

1. Push **F2** [Home] to show the HOME screen.

Note:

- The keypad will show [Home] in the top right corner when the HOME screen is active.
- If [Home] is not shown on **F2**, push **F1** [Back] to show [Home] on **F2**.

2. Push **F2** [Menu].

10:00 am FWD Rdy	Home
Freq Reference (AI)	
U1-01 Hz	0.00
Output Frequency	
U1-02 Hz	0.00
Output Current	
U1-03 A	0.00
Menu	

3. Push **▲** or **▼** to select [Monitors], then push **↵**.

10:00 am FWD Rdy	Menu
Monitors	
Parameters	
User Custom Parameters	
Parameter Backup/Restore	
Modified Param / Fault Log	
Auto-Tuning	
Home	

4. Push **▲** or **▼** to select [Custom Monitor], then push **↵**.

10:00 am FWD Rdy	Monitor
Standard Monitor	
Custom Monitor	
Bar Graph	
Analog Gauge	
Trend Plot	
Back	Home Setup

The keypad shows the selected monitor as shown in this figure.

10:00 am FWD Rdy	Monitor
Motor Speed	
U1-05 Hz	20.00
Output Power	
U1-08 kw	15.0
Terminal AI Level	
U1-13 %	30.0
Home	

- When there are a minimum of two screens, push **▲** or **▼** to switch between screens.
- If you registered only one custom monitor to [Custom Monitor 1], the screen will show only one monitor. If you registered custom monitors only to [Custom Monitor 1] and [Custom Monitor 2], the screen will show only two monitors.

◆ Set the Monitors to Show as a Bar Graph

The procedure in this section shows how to show the frequency reference monitor as a bar graph.

1. Push **F2** [Home] to show the HOME screen.

Note:

- The keypad will show [Home] in the top right corner when the HOME screen is active.
- If [Home] is not shown on **F2**, push **F1** [Back] to show [Home] on **F2**.

2. Push **F2** [Menu].

10:00 am	FWD	Rdy	Home
Freq Reference (AI)			
U1-01	Hz		0.00
Output Frequency			
U1-02	Hz		0.00
Output Current			
U1-03	A		0.00
Menu			

3. Push **▲** or **▼** to select [Monitors], then push **↵**.

10:00 am	FWD	Rdy	Menu
Monitors			
Parameters			
User Custom Parameters			
Parameter Backup/Restore			
Modified Param / Fault Log			
Auto-Tuning			
Home			

4. Push **▲** or **▼** to select [Bar Graph], then push **F3** [Setup].

10:00 am	FWD	Rdy	Monitor
Standard Monitor			
Custom Monitor			
Bar Graph			
Analog Gauge			
Trend Plot			
Back	Home	Setup	

5. Push **▲** or **▼** to select the location to store the monitor, then push **↵**.

10:00 am	FWD	Setup
Custom Monitor 1		
Custom Monitor 2		
Custom Monitor 3		
Back	Home	

6. Push **↵**.

10:00 am	FWD	Setup
Custom Monitor 1		
Custom Monitor 1		
o1-24	101	(101)
1st Monitor Area Selection		
o1-41	0	(0)
Back	Home	

7. Push **▲** or **▼** to select the monitor number to register, then push **↵**.

Set the x-xx part of monitor *Ux-xx*. For example, to show monitor *U1-01* [Frequency Reference], set it to "101" as shown in this figure.

10:00 am	FWD	Parameters
Custom Monitor 1		
o1-24		
	101	
Frequency Reference		
Default : 101		
Back	Default	

The configuration procedure is complete.

◆ Show Monitors as Bar Graphs

The procedure in this section shows how to show a specific monitor as a bar graph. You can show a maximum of three.

1. Push **F2** (Home) to show the HOME screen.

Note:

- When the drive is in HOME Mode, the screen shows [Home] in the upper right-hand corner of the screen.
- If the screen does not show [Home] for **F2**, push **F1** (Back), and then push **F2** to show [Home].

2. Push **F2** (Menu).

10:00 am	FWD	Rdy	Home
Freq Reference (AI)			
U1-01	Hz		0.00

Output Frequency			
U1-02	Hz		0.00

Output Current			
U1-03	A		0.00

Menu			

3. Push **▲** or **▼** to select [Monitors], then push **↻**.

10:00 am	FWD	Rdy	Menu
Monitors			
Parameters			
User Custom Parameters			
Parameter Backup/Restore			
Modified Param / Fault Log			
Auto-Tuning			

Home			

4. Push **▲** or **▼** to select [Display Bar Graph], then push **↻**.

10:00 am	FWD	Rdy	Monitor
Standard Monitor			
Custom Monitor			
Bar Graph			
Analog Gauge			
Trend Plot			

Back	Home	Setup	

The screen will show the monitors as shown in this figure.

10:00 am	FWD	Rdy	Monitor
U1-01			
40.00Hz	-100%	0%	100%
U1-02			
40.00Hz	-100%	0%	100%
U1-03			
3.0A	-100%	0%	100%

Home			

◆ Set the Monitors to Show as Analog Gauges

The procedure in this section shows how to show the frequency reference monitor as an analog gauge.

1. Push **F2** [Home] to show the HOME screen.

Note:

- The keypad will show [Home] in the top right corner when the HOME screen is active.
- If [Home] is not shown on **F2**, push **F1** [Back] to show [Home] on **F2**.

2. Push **F2** [Menu].

10:00 am	FWD	Rdy	Home
Freq Reference (AI)			
U1-01	Hz		0.00



Output Frequency			
U1-02	Hz		0.00

Output Current			
U1-03	A		0.00

Menu			

3. Push  or  to select [Monitors], then push .



10:00 am FWD Rdy Menu
Monitors
Parameters
User Custom Parameters
Parameter Backup/Restore
Modified Param / Fault Log
Auto-Tuning
Home

4. Push  or  to select [Analog Gauge], then push **F3** [Setup].

10:00 am FWD Rdy Monitor
Standard Monitor
Custom Monitor
Bar Graph
Analog Gauge
Trend Plot
Back Home Setup

5. Push .

10:00 am FWD Setup
Analog Gauge
Custom Monitor 1
o1-24 101 (101)
Analog Gauge Area Selection
o1-55 1 (1)
Back Home

6. Push  or  to select the monitor number to register, then push .
Set the x-xx part of monitor Ux-xx. For example, to show monitor U1-01 [Frequency Reference], set it to "101" as shown in this figure.

10:00 am FWD Parameters
Custom Monitor 1
o1-24 101
Frequency Reference
Default : 101
Back Default

The configuration procedure is complete.

◆ Display Monitors as an Analog Gauge

The following explains how to display the contents selected for a monitor as an analog gauge.

1. Push **F2** [Home] to show the HOME screen.

Note:

- The keypad will [Home] in the top right corner when the HOME screen is active.
- If [Home] is not shown on **F2**, push **F1** [Back] to show [Home] on **F2**.

2. Push **F2** [Menu].

10:00 am FWD Rdy Home
Freq Reference (AI)
U1-01 Hz 0.00
Output Frequency
U1-02 Hz 0.00
Output Current
U1-03 A 0.00
Menu

- Push or to select [Monitors], then push .

10:00 am	FWD	Rdy	Menu
Monitors			
Parameters			
User Custom Parameters			
Parameter Backup/Restore			
Modified Param / Fault Log			
Auto-Tuning			
Home			

- Push or to select [Analog Gauge], then push .

10:00 am	FWD	Rdy	Monitor
Standard Monitor			
Custom Monitor			
Bar Graph			
Analog Gauge			
Trend Plot			
Back	Home	Setup	

It will be displayed as follows.

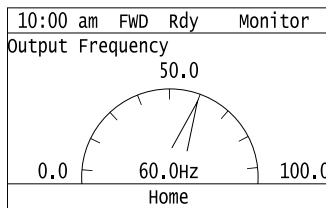

◆ Set Monitoring Items to be Shown as a Trend Plot

You must set the items in this figure to display as a trend plot.

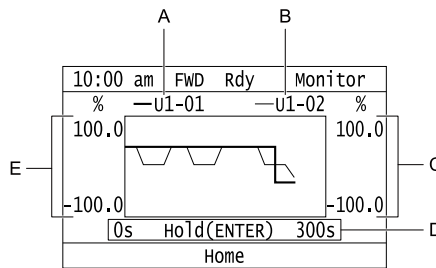

- A - Monitor Parameter 1 (set with [Custom Monitor 1])
- B - Monitor Parameter 2 (set with [Custom Monitor 2])
- C - Trend Plot 2 Scale Maximum/Minimum Value
- D - Trend Plot Time Scale
- E - Trend Plot 1 Scale Maximum/Minimum Value

■ Select Monitor Items to Show as a Trend Plot

The procedure in this section shows how to show the frequency reference monitor as a trend plot.

- Push [Home] to show the HOME screen.

Note:

- The keypad will show [Home] in the top right corner when the HOME screen is active.
- If [Home] is not shown on , push [Back] to show [Home] on .

- Push [Menu].

10:00 am	FWD	Rdy	Home
Freq Reference (AI)			
U1-01	Hz	0.00	
Output Frequency			
U1-02	Hz	0.00	
Output Current			
U1-03	A	0.00	
Menu			

3. Push  or  to select [Monitors], then push .

10:00 am FWD Rdy Menu
Monitors
Parameters
User Custom Parameters
Parameter Backup/Restore
Modified Param / Fault Log
Auto-Tuning
Home

4. Push  or  to select [Trend Plot], then push **F3** [Setup].

10:00 am FWD Rdy Monitor
Standard Monitor
Custom Monitor
Bar Graph
Analog Gauge
Trend Plot
Back Home Setup

5. Push  or  to select [Custom Monitor 1], then push .

10:00 am FWD Setup
Custom Monitor 1
Custom Monitor 2
Trend Plot Time Scale Setting
Back Home

6. Push .

10:00 am FWD Setup
Custom Monitor 1
Custom Monitor 1
o1-24 101 (101)
Trend Plot 1 Scale Minimum Value
o1-47 -100.0 (-100.0)%
Back Home





7. Push  or  to select the monitor number to register, then push .

Set the x-xx part of monitor Ux-xx. For example, to show monitor U1-01 [Frequency Reference], set it to "101" as shown in this figure.



10:00 am FWD Parameters
Custom Monitor 1
o1-24 101
Frequency Reference
Default : 101
Back Default

8. Push  or  to select [Trend Plot 1 Scale Minimum Value], then push .

10:00 am FWD Setup
Custom Monitor 1
Trend Plot 1 Scale Minimum Value
o1-47 -100.0 (-100.0)%
Trend Plot 1 Scale Maximum Value
o1-48 100.0 (100.0)%
Back Home



9. Push  or  to select the specified digit, then push  or  to select the correct number.

10:00 am	FWD	Parameters
Trend Plot 1 Scale Minimum Value		
01-47	-	100.0 %
Default : -100.0%		
Range : -300.0~ 99.9		
Back	Default	Min/Max





- Push  [Default] to set the parameters to factory defaults.
- Push  [Min/Max] to move between the minimum value and maximum value.

10. Push  to keep the changes.



10:00 am	FWD	Parameters
Trend Plot 1 Scale Minimum Value		
01-47	00	20.0 %
Default : -100.0%		
Range : -300.0~ 99.9		
Back	Default	Min/Max

11. Push  or  to select [Trend Plot 1 Scale Maximum Value], then push .

10:00 am	FWD	Setup
Custom Monitor 1		
Trend Plot 1 Scale Minimum Value		
01-47	100.0	(-100.0)%
Trend Plot 1 Scale Maximum Value		
01-48	100.0	(100.0)%
Back Home		

12. Push  or  to select the specified digit, then push  or  to select the correct number.

10:00 am	FWD	Parameters
Trend Plot 1 Scale Maximum Value		
01-48	0	100.0 %
Default : 100.0%		
Range : 20.1~ 300.0		
Back	Default	Min/Max

- Push  [Default] to set the parameters to factory defaults.
- Push  [Min/Max] to move between the minimum value and maximum value.

13. Push  to keep the changes.

10:00 am	FWD	Parameters
Trend Plot 1 Scale Maximum Value		
01-48	00	80.0 %
Default : 100.0%		
Range : 20.1~ 300.0		
Back	Default	Min/Max

14. Push  [Back].



If necessary, use the same procedure to set [Custom Monitor 2].

■ Set the Time Scale for the Trend Plot Monitor

The procedure in this section shows how to set the time scale for the trend plot monitor.

1. Push  (Home) to show the HOME screen.

Note:

- The keypad will show [Home] in the top right corner when the HOME screen is active.
- If [Home] is not shown on , push  (Back) to show [Home] on .

2. Push **F2** (Menu).

10:00 am	FWD	Rdy	Home
Freq Reference (AI)			
U1-01	Hz		0.00
Output Frequency			
U1-02	Hz		0.00
Output Current			
U1-03	A		0.00
Menu			

3. Push **▲** or **▼** to select [Monitors], then push **↵**.

10:00 am	FWD	Rdy	Menu
Monitors			
Parameters			
User Custom Parameters			
Parameter Backup/Restore			
Modified Param / Fault Log			
Auto-Tuning			
Home			

4. Push **▲** or **▼** to select [Trend Plot], then push **F3** (Setup).

10:00 am	FWD	Rdy	Monitor
Standard Monitor			
Custom Monitor			
Bar Graph			
Analog Gauge			
Trend Plot			
Back Home Setup			

5. Push **▲** or **▼** to select [Trend Plot Time Scale Setting], then push **↵**.

10:00 am	FWD		Setup
1st Monitor Setting			
2nd Monitor Setting			
Trend Plot Time Scale Setting			
Back Home			

6. Push **◀** or **▶** to select the specified digit, then push **▲** or **▼** to select the correct number.

10:00 am	FWD		Parameters
Trend Plot Time Scale Setting			
01-51		0 300	sec
Default : 300sec			
Range : 1~3600			
Back Default Min/Max			

- Push **F2** (Default) to set the parameters to the factory default.
- Push **F3** (Min/Max) to move between the minimum value and maximum value.

7. Push **↵** to keep the changes.

10:00 am	FWD		Parameters
Trend Plot Time Scale Setting			
01-51		1 300	sec
Default : 300sec			
Range : 1~3600			
Back Default Min/Max			

The configuration procedure is complete.

◆ Show Monitor Items as a Trend Plot

The procedure in this section shows how to show the selected monitor data as a trend plot.

4.6 Keypad Operation

1. Push **F2** [Home] to show the HOME screen.

Note:

- The keypad will [Home] in the top right corner when the HOME screen is active.
- If [Home] is not shown on **F2**, push **F1** [Back] to show [Home] on **F2**.

2. Push **F2** [Menu].

10:00 am	FWD	Rdy	Home
Freq Reference (AI)			
U1-01	Hz		0.00
Output Frequency			
U1-02	Hz		0.00
Output Current			
U1-03	A		0.00
Menu			

3. Push **▲** or **▼** to select [Monitors], then push **↵**.

10:00 am	FWD	Rdy	Menu
Monitors			
Parameters			
User Custom Parameters			
Parameter Backup/Restore			
Modified Param / Fault Log			
Auto-Tuning			
Home			

4. Push **▲** or **▼** to select [Trend Plot], then push **↵**.

10:00 am	FWD	Rdy	Monitor
Standard Monitor			
Custom Monitor			
Bar Graph			
Analog Gauge			
Trend Plot			
Back Home Setup			

The screen will show the monitors as shown in this figure.

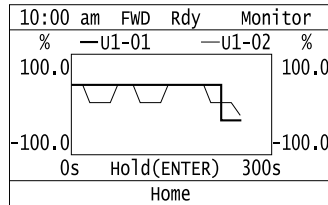

Note:

Push **↵** [Hold] to switch between Pause and Restart for the monitor display. The "Hold (ENTER)" message flashes while you pause monitoring.

◆ Change Parameter Setting Values

This example shows how to change the setting value for *CI-01 [Acceleration Time 1]*. Do the steps in this procedure to set parameters for the application.

1. Push **F2** (Home) to show the HOME screen.

Note:

- When the drive is in HOME Mode, the screen shows [Home] in the upper right-hand corner of the screen.
- If [Home] is not shown above the **F2**, push **F1** (Back).

2. Push **F2** (Menu).

10:00 am	FWD	Rdy	Home
Freq Reference (AI)			
U1-01	Hz		0.00
Output Frequency			
U1-02	Hz		0.00
Output Current			
U1-03	A		0.00
Menu			

3. Push  or  to select [Parameters], then push .



10:00 am FWD	Menu
Monitors	
Parameters	
User Custom Parameters	
Parameter Backup/Restore	
Modified Param / Fault Log	
Auto-Tuning	
Home	

4. Push  or  to select [C Tuning], then push .





10:00 am FWD	Parameters
A Initialization Parameters	
b Application	
C Tuning	
d References	
E Motor Parameters	
F Options	
Back	Home

5. Push  or  to select [C1 Accel & Decel Time], then push .



10:00 am FWD	Parameters
C1 Accel & Decel Time	
C2 S-Curve Characteristics	
C3 Slip Compensation	
C4 Torque Compensation	
C6 Duty & Carrier Frequency	
Back	Home

6. Push  or  to select C1-01, then push .

10:00 am FWD	Parameters
Acceleration Time 1	
C1-01 10.0 (10.0)sec	
Deceleration Time 1	
C1-02 10.0 (10.0)sec	
Acceleration Time 2	
C1-03 10.0 (10.0)sec	
Back	Home



7. Push  or  to select the specified digit, then push  or  to select the correct number.

10:00 am FWD	Parameters
Acceleration Time 1	
C1-01 00 10.0sec	
Default : 10.0sec	
Range : 0.0~6000.0	
Back	Default Min/Max

- Push  (Default) to set the parameter to factory default.
- Push  (Min/Max) to show the minimum value or the maximum value on the display.

8. Push  to keep the changes.

10:00 am FWD	Parameters
Acceleration Time 1	
C1-01 00 2 0.0 sec	
Default : 10.0 sec	
Range : 0.0~6000.0	
Back	Default Min/Max

9. Continue to change parameters, then push  (Back),  (Home) to go back to the home screen after you change all the applicable parameters.

◆ Examine User Custom Parameters

The User Custom Parameters show the parameters set in A2-01 to A2-32 [User Parameter 1 to User Parameter 32]. This lets users to quickly access and change settings to these parameters.

Note:

The User Custom Parameters always show A1-06 [Application Selection] at the top of the list. The A2-01 to A2-32 settings change when the A1-06 setting changes, which makes it easier to set and reference the necessary parameter settings.

1. Push **F2** (Home) to show the HOME screen.

Note:

- When the drive is in HOME Mode, the screen shows [Home] in the upper right-hand corner of the screen.
- If [Home] is not shown on **F2**, push **F1** (Back) to show [Home] on **F2**.

2. Push **F2** (Menu).

10:00 am FWD Rdy	Home
Freq Reference (AI)	
U1-01 Hz	0.00
Output Frequency	
U1-02 Hz	0.00
Output Current	
U1-03 A	0.00
Menu	

3. Push **▲** or **▼** to select [User Custom Parameters], then push **↵**.

10:00 am FWD	Menu
Monitors	
Parameters	
User Custom Parameters	▶
Parameter Backup/Restore	
Modified Param / Fault Log	
Auto-Tuning	
Home	

4. Push **▲** or **▼** to show the parameter to examine.

10:00 am FWD	Parameters
Application Preset	
A1-06	0 (0)
Control Method Selection	
A1-02	2 (2)
Frequency Reference Selection 1	
b1-01	1 (1)
Back	Home

5. To re-edit a parameter, push **▲** or **▼**, select the parameter to edit, then push **↵**.

10:00 am FWD	Parameters
Application Preset	
A1-06	0 (0)
Control Method Selection	
A1-02	2 (2)
Frequency Reference Selection 1	
b1-01	1 (1)
Back	Home

6. Push **◀** or **▶** to select the digit, then push **▲** or **▼** to change the value.

10:00 am FWD	Parameters
Control Method Selection	
A1-02	2
Open Loop Vector Control	
Default : 2	
Back	Default

7. When you are done changing the value, push .

10:00 am FWD	Parameters
Control Method Selection	
A1-02	0
V/f Control	
Default : 2	
Back	Default

The parameter setting procedure is complete.

◆ Save a Backup of Parameters



You can save a backup of the drive parameters to the keypad. The keypad can store parameter setting values for a maximum of four drives in different storage areas. Backups of the parameter settings can save time when you set parameters after you replace a drive. When you set up more than one drive, you can copy the parameter settings from a drive that completed a test run to the other drives.

Note:

- Stop the motor before you back up parameters.
- The drive will not accept a Run command while it makes a backup.
- The DriveWorksEZ PC software password is necessary to back up *qx-xx* [DriveWorksEZ Parameter] and *rx-xx* [DWEZ Connection Parameter]. If you enter an incorrect password, the drive detects *PWEr* [DWEZ Password Mismatch].

1. Push  (Home) to show the HOME screen.

Note:



- When the drive is in HOME Mode, the screen shows [Home] in the upper right-hand corner of the screen.
- If [Home] is not shown on , push  (Back) to show [Home] on .

2. Push  (Menu).

10:00 am FWD Rdy	Home
Freq Reference (AI)	
U1-01 Hz	0.00
Output Frequency	
U1-02 Hz	0.00
Output Current	
U1-03 A	0.00
Menu	

3. Push  or  to select [Parameter Backup/Restore], then push .



10:00 am FWD	Menu
Monitors	
Parameters	
User Custom Parameters	
Parameter Backup/Restore	
Modified Param / Fault Log	
Auto-Tuning	
Home	

4. Push  or  to select the items to back up, then push .

10:00 am FWD	Backup
Select Items to Backup/Restore	
Standard Parameters	
Back	
Home	

5. Push  or  to select [Backup (drive → keypad)], then push .

10:00 am FWD	Backup
Select Desired Action	
Backup (drive → keypad)	
Restore (keypad → drive)	
Verify (check for mismatch)	
Erase (backup data of keypad)	
Back	
Home	

6. Push  or  to select a memory location, then push .

10:00 am	FWD	Backup
Select Backup/Restore Location		
#1	No Data	▶
#2	No Data	
#3	No Data	
#4	No Data	
Back		Home

The keypad shows “End” when the backup procedure completes successfully.

◆ Write Backed-up Parameters to the Drive



You can back up parameters on the keypad and write them to different drives.

Note:

- Always stop the drive before you start to restore the parameter backups.
- While you verify parameters, the drive will not accept Run commands.

1. Push  (Home) to show the HOME screen.







Note:



- When the drive is in HOME Mode, the screen shows [Home] in the upper right-hand corner of the screen.
- If the screen does not show [Home] for , push  (Back), and then push  to show [Home].

2. Push  (Menu).



10:00 am	FWD	Rdy	Home
Freq Reference (AI)			
U1-01	Hz		0.00
Output Frequency			
U1-02	Hz		0.00
Output Current			
U1-03	A		0.00
Menu			

3. Push  or  to select [Parameter Backup/Restore], then push .

10:00 am	FWD	Menu
	Monitors	
	Parameters	
	User Custom Parameters	
	Parameter Backup/Restore	▶
	Modified Param / Fault Log	
	Auto-Tuning	
Back		Home

4. Push  or  to select the item to restore, then push .

10:00 am	FWD	Backup
Select Items to Backup/Restore		
Standard Parameters ▶		
Back		Home

5. Push  or  to select [Restore (keypad → drive)], then push .

10:00 am	FWD	Backup
Select Desired Action		
Backup (drive → keypad)		
Restore (keypad → drive) ▶		
Verify (check for mismatch)		
Erase (backup data of keypad)		
Back		Home

6. Push  or  to select the backed-up parameter data, then push .

10:00 am	FWD	Backup
Select Backup/Restore Location		
#1	2016/01/01 13:00	0-62
#2	No Data	
#3	No Data	
#4	No Data	
Back		Home

The keypad will show the “End” message when the write process is complete.

Note:

The keypad display changes when the settings and conditions change.

		A	B	C
	10:00 am	FWD	Backup	
	Select Backup/Restore Location			
	#1	2016/01/01 14:10	0-62	
F	#2	2016/01/01 02:10pm	1-62	*
E	#3	----/--/-- --:--	2-62	*
D	#4	No Data		
Back		Home		

A - A1-02 [Control Method Selection] settings

B - o2-04 [Drive Model (KVA) Selection] settings (2 or 3 digits)

C - Presence of DriveWorksEZ parameter backup

D - Parameter backup data is not registered

E - Backup data does not contain the date information

F - Backup date

◆ Verify Keypad Parameters and Drive Parameters



This procedure makes sure that the parameter setting values that you backed up in the keypad agree with the parameter setting values in the drive.

Note:

- Always stop the drive before you start to verify the parameters.
- While you restore parameters, the drive will not accept Run commands.

1. Push  (Home) to show the HOME screen.

Note:



- When the drive is in HOME Mode, the screen shows [Home] in the upper right-hand corner of the screen.
- If the screen does not show [Home] for , push  (Back), and then push  to show [Home].

2. Push  (Menu).

10:00 am	FWD	Rdy	Home
Freq Reference (AI)			
U1-01	Hz		0.00
Output Frequency			
U1-02	Hz		0.00
Output Current			
U1-03	A		0.00
Menu			

3. Push  or  to select [Parameter Backup/Restore], then push .



10:00 am	FWD	Menu
Monitors		
Parameters		
User Custom Parameters		
Parameter Backup/Restore		
Modified Param / Fault Log		
Auto-Tuning		
Home		

4. Push  or  to select the item to verify, then push .

10:00 am	FWD	Backup
Select Items to Backup/Restore		
Standard Parameters ▶		
Back Home		

5. Push  or  to select [Verify (drive → keypad)], then push .

10:00 am	FWD	Backup
Select desired action.		
Backup (drive → keypad)		
Restore (keypad → drive)		
Verify (check for mismatch) ▶		
Erase (backup data of keypad)		
Back Home		

6. Push  or  to select the data to verify, then push .

10:00 am	FWD	Backup
Select Backup/Restore Location		
#1 2016/01/01 13:00 0-62 ▶		
#2 No Data		
#3 No Data		
#4 No Data		
Back Home		

The keypad shows “End” when the parameter settings backed up in the keypad agree with the parameter settings copied to the drive.

Note:



The keypad shows *vFyE [Parameters do not Match]* when the parameter settings backed up in the keypad do not agree with the parameter settings copied to the drive. Push one of the keys to return to the screen in Step 6.

◆ Delete Parameters Backed Up to the Keypad

This procedure deletes the parameters that you backed up to the keypad.

1. Push  (Home) to show the HOME screen.

Note:



- When the drive is in HOME Mode, the screen shows [Home] in the upper right-hand corner of the screen.
- If the screen does not show [Home] for , push  (Back), and then push  to show [Home].

2. Push  (Menu).



10:00 am	FWD	Rdy	Home
Freq Reference (AI)			
U1-01	Hz		0.00
Output Frequency			
U1-02	Hz		0.00
Output Current			
U1-03	A		0.00
Menu			

3. Push  or  to select [Parameter Backup/Restore], then push .



10:00 am	FWD	Menu
Monitors		
Parameters		
User Custom Parameters		
Parameter Backup/Restore ▶		
Modified Param / Fault Log		
Auto-Tuning		
Home		

4. Push  or  to select the item to delete, then push .

10:00 am FWD	Backup
Select Items to Backup/Restore	
Standard Parameters ▶	
Back	Home

5. Push  or  to select [Erase (backup data of keypad)], then push .

10:00 am FWD	Backup
Select desired action.	
Backup (drive → keypad)	
Restore (keypad → drive)	
Verify (check for mismatch)	
Erase (backup data of keypad) ▶	
Back	Home

6. Push  or  to select the data to delete, then push .

10:00 am FWD	Backup
Select Backup/Restore Location	
#1 2016/01/01 14:10 0-62 ▶	
#2 2016/01/01 02:10pm 1-62	
#3 ----/--/-- ---:-- 2-62	
#4 No Data	
Back	Home



The keypad will show the “End” message when the write process is complete.

◆ Check Modified Parameters

This procedure will show all parameters that are not at their default values. This is very useful when you replace a drive. This lets you quickly access and re-edit changed parameters. When all parameters are at their default values, the keypad will show “0 Parameters”.

1. Push  (Home) to show the HOME screen.

Note:

- When the drive is in HOME Mode, the screen shows [Home] in the upper right-hand corner of the screen.
- If [Home] is not shown on , push  (Back) to show [Home] on .

2. Push  (Menu).

10:00 am FWD Rdy	Home
Freq Reference (AI)	
U1-01 Hz	0.00
Output Frequency	
U1-02 Hz	0.00
Output Current	
U1-03 A	0.00
Menu	

3. Push  or  to select [Modified Param / Fault Log], then push .



10:00 am FWD	Menu
Monitors	
Parameters	
User Custom Parameters	
Parameter Backup/Restore	
▲ Modified Param / Fault Log ▶	
Auto-Tuning	
Home	

4. Push  or  to select [Modified Parameters], then push .

10:00 am	FWD	History
Modified Parameters		
▲ Fault Log		
Back	Home	

5. Push .





10:00 am	FWD	Modified
User Modified Parameters		
Standard Parameters		
2 Parameters		
Back	Home	

6. Push  or  to show the parameter to examine.

10:00 am	FWD	Modified
Acceleration Time 1		
c1-01	20.0	(10.0)sec
Motor Rated Current (FLA)		
E2-01	97.2	(77.2)A
Back	Home	

7. To re-edit a parameter, push  or , select the parameter to edit, then push .

10:00 am	FWD	Modified
Acceleration Time 1		
c1-01	20.0	(10.0)sec
Motor Rated Current (FLA)		
E2-01	97.2	(77.2)A
Back	Home	

8. Push  or  to select the digit, then push  or  to change the value.

10:00 am	FWD	Parameters
Acceleration Time 1		
c1-01	0020.0	sec
Default : 10.0sec		
Range : 0.0~6000.0		
Back	Default	Min/Max

9. When you are done changing the value, push .

10:00 am	FWD	Parameters
Acceleration Time 1		
c1-01	0030.0	sec
Default : 10.0sec		
Range : 0.0~6000.0		
Back	Default	Min/Max

The parameter revision procedure is complete.

◆ Restore Modified Parameters to Defaults

This procedure will set all parameters with changed values to their default settings.

1. Push **F2** (Home) to show the HOME screen.

Note:

- The keypad will show [Home] in the top right corner when the HOME screen is active.
- If [Home] is not shown on **F2**, push **F1** (Back) to show [Home] on **F2**.

2. Push **F2** (Menu).

10:00 am	FWD	Rdy	Home
Freq Reference (AI)			
U1-01	Hz		0.00
Output Frequency			
U1-02	Hz		0.00
Output Current			
U1-03	A		0.00
Menu			

3. Push **▲** or **▼** to select [Modified Param / Fault Log], then push **↵**.

10:00 am	FWD		Menu
Monitors			
Parameters			
User Custom Parameters			
Parameter Backup/Restore			
▲ Modified Param / Fault Log ▶			
Auto-Tuning			
Home			

4. Push **▲** or **▼** to select [Modified Parameters], then push **↵**.

10:00 am	FWD		History
Modified Parameters ▶			
▲ Fault Log			
Back Home			

5. Push **↵**.

10:00 am	FWD		Modified
User Modified Parameters			
Standard Parameters ▶			
2 Parameters			
Back Home			

6. Push **▲** or **▼** to select the parameters to return to their default settings, then push **↵**.

10:00 am	FWD		Modified
Acceleration Time 1			
C1-01	20.0	(10.0)sec	
Motor Rated Current (FLA)			
E2-01	97.2	(77.2)A	
Back Home			

7. Push **F2** (Default).

10:00 am	FWD		Parameters
Acceleration Time 1			
C1-01	0020.0	sec	
Default : 10.0sec			
Range : 0.0~6000.0			
Back Default Min/Max			

8. Push .

10:00 am	FWD	Parameters
Acceleration Time 1		
C1-01	0010.0	sec
Default : 10.0sec		
Range : 0.0~6000.0		
Back	Default	Min/Max

The modified parameters are now set to default values.

◆ Show Fault History



You can examine a maximum of 10 fault codes and dates and times that the faults occurred.

Note:

- To monitor the date and time of faults, you must first set the date and time on the keypad.
- If the keypad does not have a clock battery, you must set the date and time each time you energize the drive.

1. Push  (Home) to show the HOME screen.

Note:

- The keypad will show [Home] in the top right corner when the HOME screen is active.
- If [Home] is not shown on , push  (Back) to show [Home] on .

2. Push  (Menu).



10:00 am	FWD	Rdy	Home
Freq Reference (AI)			
U1-01	Hz		0.00
Output Frequency			
U1-02	Hz		0.00
Output Current			
U1-03	A		0.00
Menu			

3. Push  or  to select [Modified Param / Fault Log], then push .

10:00 am	FWD	Menu
Monitors		
Parameters		
User Custom Parameters		
Parameter Backup/Restore		
▲ Modified Param / Fault Log ▶		
Auto-Tuning		
Home		

4. Push  or  to select [Fault Log], then push .

10:00 am	FWD	History
Modified Parameters		
▲ Fault Log ▶		
Back Home		

5. Push  or  to show the fault history you will examine.

10:00 am	FWD	History
Fault History Log		
01 ov	2016/01/01 14:00	Overvoltage
02 oc	2016/01/01 14:00	Overcurrent
Back Home		

◆ Auto-Tuning the Drive

Auto-Tuning uses motor characteristics to automatically set drive parameters.

Refer to the motor nameplate or the motor test report for the necessary information for Auto-Tuning.

VARTSPEED									
3-PHASE PERMANENT MAGNET MOTOR									
TYPE SST4-					POLES E5-04				
PROTECTION					COOLING				
kw	V	Hz	RATING	A	r/min	r _i	E5-05		
E5-02	E1-05			E5-03	E1-04,06	Ld	E5-06		
						Lq	E5-07		
						Ke	E5-09		
TNS		COOLANT TEMP.		°C	ALTITUDE	m	Δθ	E5-11	
STD		DRIVE		OPP		MASS	Kg	Δθ	
BRG NO		END		END				Ki	
SER NO		YEAR						Kt	
YASKAWA ELECTRIC CORPORATION					JAPAN				
					Si				

Figure 4.12 Motor Nameplate (Example)

WARNING! Sudden Movement Hazard. Before you do Auto-Tuning, remove all personnel and objects from the area around the drive, motor, and load. The drive and motor can start suddenly during Auto-Tuning and cause serious injury or death.

WARNING! Electrical Shock Hazard. During Auto-Tuning, the motor will receive high voltage when the motor is stopped. Do not touch the motor until Auto-Tuning is complete. If you touch a motor that is energized, it can cause serious injury or death.

WARNING! Sudden Movement Hazard. Before you do Rotational Auto-Tuning, disconnect the load from the motor. The load can move suddenly and cause serious injury or death.

This procedure shows how to do Rotational Auto-Tuning.

1. Push **F2** (Home) to show the HOME screen.

Note:

- When the drive is in HOME Mode, the screen shows [Home] in the upper right-hand corner of the screen.
- If the screen does not show [Home] for **F2**, push **F1** (Back), and then push **F2** to show [Home].

2. Push **F2** (Menu).

10:00 am	FWD	Rdy	Home
Freq Reference (AI)			
U1-01	Hz		0.00
Output Frequency			
U1-02	Hz		0.00
Output Current			
U1-03	A		0.00
Menu			

3. Push **▲** or **▼** to select [Auto-Tuning], then push **↵**.

10:00 am	FWD	Menu
Parameters		
User Custom Parameters		
Parameter Backup/Restore		
Modified Param / Fault Log		
Auto-Tuning		
Initial Setup		
Home		

4. Push **↵**.

10:00 am	FWD	Auto Tuning
Select Auto-Tuning mode		
Motor Parameter Tuning		
Back Home		

5. Push **▲** or **▼** to select [Rotational Auto-Tuning], then push **↵**.

10:00 am	FWD	Auto Tuning
Select Auto-Tuning method		
Rotational Auto-Tuning		
Stationary Auto-Tuning		
Stationary Line-Line Resistance		
Back Home		

6. Follow the messages shown on the keypad to input the necessary Auto-Tuning data.

Example: Push **◀** or **▶** to select the specified digit, then push **▲** or **▼** to change the number.

Push **↵** to save the change and move to the next entry field.

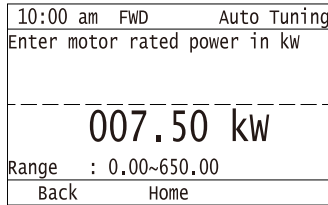

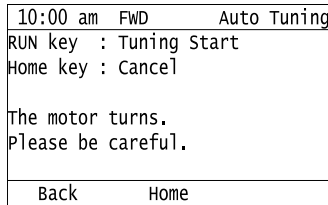

7. Follow the messages shown on the keypad to do the next steps.
8. When the keypad shows the Auto-Tuning start screen, push .





Auto-Tuning starts.

When doing Rotational Auto-Tuning, the motor will stay stopped for approximately one minute with power energized and then the motor will start to rotate.

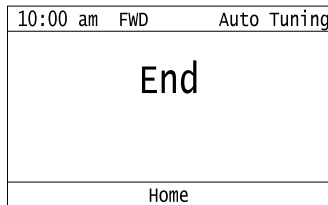

9. When the keypad shows this screen after Auto-Tuning is complete for 1 or 2 minutes, push  or .

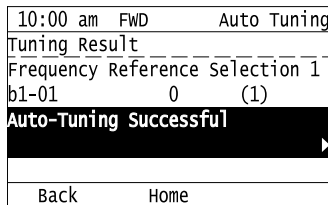

The keypad will show a list of the changed parameters as the result of Auto-Tuning.

10. Push  or  in the parameter change confirmation screen to check the changed parameters, then select [Auto-Tuning Successful] at the bottom of the screen and push .



To change a parameter again, push  or  to select the parameter to change, then push  to show the parameter setting screen.

Auto-Tuning is complete.

Note:

If the drive detects an error or you push  before Auto-Tuning is complete, Auto-Tuning will stop and the keypad will show an error code. *Endx* identifies that Auto-Tuning was successful with calculation errors. Find and repair the cause of the error and do Auto-Tuning again, or set the motor parameters manually. You can use the drive in the application if you cannot find the cause of the *Endx* error. *Er-xx* identifies that Auto-Tuning was not successful. Find and repair the cause of the error and do Auto-Tuning again.

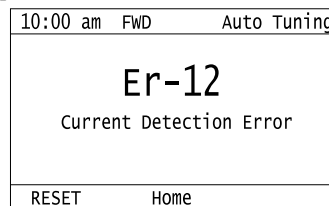
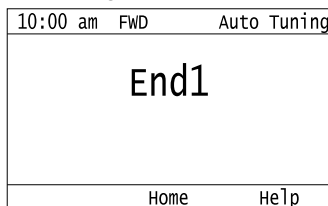

◆ Set the Keypad Language Display

The procedure in this section shows how to set the language shown on the keypad.

1. Push **F2** (Home) to show the HOME screen.

Note:

- The keypad will show [Home] in the top right corner when the HOME screen is active.
- If [Home] is not shown on **F2**, push **F1** (Back), to show [Home] on **F2**.

2. Push **F2** (Menu).

10:00 am	FWD	Rdy	Home
Freq Reference (AI)			0.00
U1-01	Hz		0.00
Output Frequency			0.00
U1-02	Hz		0.00
Output Current			0.00
U1-03	A		
Menu			

3. Push **▲** or **▼** to select [Initial Settings], then push **↵**.

10:00 am	FWD	Menu
	User Custom Parameters	
	Parameter Backup/Restore	
	Modified Param / Fault Log	
	Auto-Tuning	
	Initial Setup	
	Diagnostic Tools	
Home		

4. Push **▲** or **▼** to select [Language Selection], then push **↵**.

10:00 am	FWD	Init Setup
	Language Selection	
	Set Date/Time	
	Setup Wizard	
	Show Initial Setup Screen	
Back		Home

5. Push **▲** or **▼** to select the language, then push **↵**.

10:00 am	FWD	Init Setup
Language Selection		
English		
Japanese		
Deutsch		
Frangais		
Italiano		
Back		Home

The procedure to set the keypad language is complete.

◆ Set the Date and Time

The procedure in this section shows how to set the date and time.

Note:

- Refer to [Replace the Keypad Battery on page 447](#) for information about the battery installation procedure.
- To set the drive to detect an alarm when the battery is dead or when the clock is not set, install the battery then set *o4-24 = 1 [bAT Detection selection = Enable (Alarm Detected)]*.
- If the keypad does not have a clock battery, you must set the date and time each time you energize the drive.

1. Push **F2** (Home) to show the HOME screen.

Note:



- When the drive is in HOME Mode, the screen shows [Home] in the upper right-hand corner of the screen.
- If [Home] is not shown on **F2**, push **F1** (Back) to show [Home] on **F2**.

2. Push **F2** (Menu).



10:00 am	FWD	Rdy	Home
Freq Reference (AI)			
U1-01	Hz		0.00
Output Frequency			
U1-02	Hz		0.00
Output Current			
U1-03	A		0.00
Menu			

3. Push  or  to select [Initial Setup], then push .



10:00 am	FWD		Menu
User Custom Parameters			
Parameter Backup/Restore			
Modified Param / Fault Log			
Auto-Tuning			
Initial Setup			
Diagnostic Tools			
Home			

4. Push  or  to select [Set Date/Time], and push .

10:00 am	FWD		Init Setup
Language Selection			
Set Date/Time			
Setup Wizard			
Show Initial Setup Screen			
Back		Home	

5. Push  or  to select the format of date display, then push .

10:00 am	FWD		Init Setup
YYYY/MM/DD (2016/01/01)			
DD/MM/YYYY (01/01/2016)			
MM/DD/YYYY (01/01/2016)			
Back		Home	

6. Push  or  to select the format of time display, then push .





10:00 am	FWD		Init Setup
24 hour clock (00:00)			
12 hour EA clock (00:00 am)			
12 hour JP clock (00:00 am)			
Back		Home	

7. Push  or  to select the Year/Month/Day, then push  or  to change the value.

10:00 am	FWD		Init Setup
2016/01/01			
Year		Month Day	
YYYY/MM/DD			
Back		Home	

8. When you are done changing the value, push .

10:00 am	FWD		Init Setup
2016/04/01			
Year		Month Day	
YYYY/MM/DD			
Back		Home	

9. Push  or  to select the hour or minute, then push  or  to change the value.

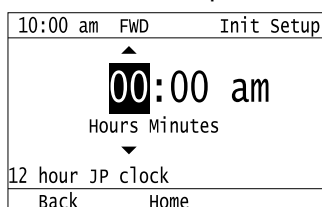

10. When you are done setting the time, push .

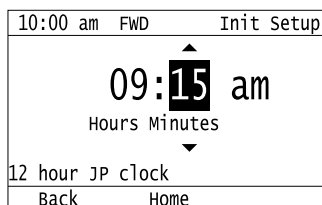

The procedure for setting the date and time is complete.

◆ Set Parameters Using the Setup Wizard

The Setup Wizard lets users follow simple messages on the keypad to set these basic parameters:

- Frequency Reference Source
- Input signal level
- Run command source
- Duty Rating
- Motor type
- Control Method Selection
- Maximum frequency
- Input/output settings

Note:

The Setup Wizard function will initialize all parameters before it sets the basic parameters.

1. Push  [Home] to show the HOME screen.







Note:



- The keypad will [Home] in the top right corner when the HOME screen is active.
- If [Home] is not shown on , push  [Back] to show [Home] on .

2. Push  [Menu].



10:00 am FWD Rdy	Home
Freq Reference (AI)	
U1-01 Hz	0.00
Output Frequency	
U1-02 Hz	0.00
Output Current	
U1-03 A	0.00
Menu	

3. Push  or  to select [Initial Setup], then push .

10:00 am FWD	Menu
 User Custom Parameters	
 Parameter Backup/Restore	
 Modified Param / Fault Log	
 Auto-Tuning	
 Initial Setup	
 Diagnostic Tools	
Home	

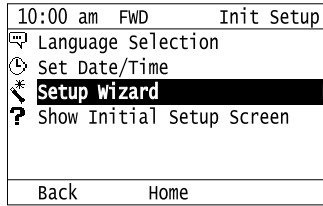
4. Push  or  to select [Setup Wizard], then push .





5. Push  or  to select [Yes], then push .

Note:

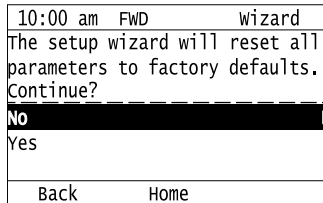
This operation will initialize all parameters.



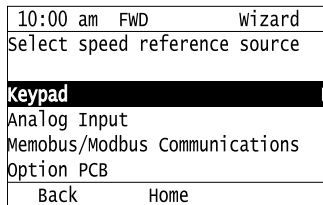

6. Push  or  to select the item to set, then push .



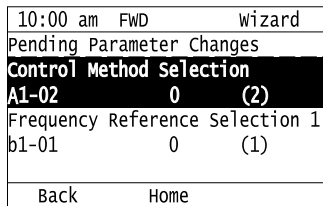

7. For the next steps, follow the instructions shown on the keypad until the “Parameter Change Confirmation Screen” is shown.



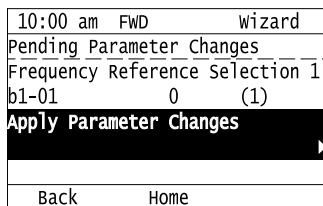

8. In the parameter change confirmation screen, push  or  to examine the changed parameter, then select [Apply of each parameter] at the bottom of the screen and push .



Note:

To change a parameter again, push  or  to select the parameter to change, then push  to show the parameter setting screen.

9. Push  or  to select [Yes], then push .

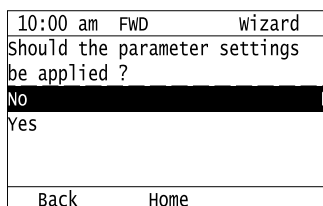

The Setup Wizard procedure is complete.

◆ Disable the Initial Setup Screen

Do the steps in this procedure to not show the initial start-up screen when the drive is energized.

1. Push **F2** (Home) to show the HOME screen.

Note:

- When the drive is in HOME Mode, the screen shows [Home] in the upper right-hand corner of the screen.
- If the screen does not show [Home] for **F2**, push **F1** (Back), and then push **F2** to show [Home].

2. Push **F2** (Menu).

10:00 am FWD Rdy	Home
Freq Reference (AI)	
U1-01 Hz	0.00
Output Frequency	
U1-02 Hz	0.00
Output Current	
U1-03 A	0.00
Menu	

3. Push **▲** / **▼** to select [Initial Setup], then push **↵**.

10:00 am FWD	Menu
⊗ User Custom Parameters	
⏪ Parameter Backup/Restore	
⚠ Modified Param / Fault Log	
🔧 Auto-Tuning	
☰ Initial Setup	▶
🔧 Diagnostic Tools	
Home	

4. Push **▲** / **▼** to select [Show Initial Setup Screen], then push **↵**.

10:00 am FWD	Init Setup
🗨 Language Selection	
🕒 Set Date/Time	
🔧 Setup Wizard	
❓ Show Initial Setup Screen	▶
Back Home	

5. Push **▲** / **▼** to select [No], then push **↵**.

10:00 am FWD	Init Setup
Show Initial Setup Screen	
No	
Yes	
Back Home	

- [No]: The keypad will not show the Initial Setup Screen when the drive is energized.
- [Yes]: The keypad will show the Initial Setup Screen when the drive is energized.

◆ Start Data Logging

The data log function saves drive status information. Monitors *Ux-xx* are the source of log information. The procedure in this section shows how to start logging data.

There are two types of data log functions:

- Long-term data log: Saves data continuously over an extended time period. You can record a maximum of 10 monitors.
- Short-term data log: Saves data over a set length of time before and after the drive detects a trigger event with a short sampling cycle. You can record a maximum of 4 monitors.

1. Make sure that a microSD card is inserted in the keypad.

4.6 Keypad Operation

- Push **F2** (Home) to show the HOME screen.

Note:

- When the drive is in HOME Mode, the screen shows [Home] in the upper right-hand corner of the screen.
- If the screen does not show [Home] for **F2**, push **F1** (Back) and then push **F2** to show [Home].

- Push **F2** (Menu).

10:00 am	FWD	Rdy	Home
Freq Reference (AI)			
U1-01	Hz		0.00
Output Frequency			
U1-02	Hz		0.00
Output Current			
U1-03	A		0.00
Menu			

- Push **▲** or **▼** to select [Diagnostic Tools], then push **↵**.

10:00 am	FWD	Menu
User Custom Parameters		
Parameter Backup/Restore		
Modified Param / Fault Log		
Auto-Tuning		
Initial Setup		
Diagnostic Tools		
Home		

- Push **▲** or **▼** to select [Data Logger], then push **↵**.

10:00 am	FWD	Tools
Data Logger		
Backlight		
Drive Information		
Back	Home	Setup

- Push **▲** or **▼** to select [Yes] or [No], then push **↵**.

10:00 am	FWD	Tools
Begin Data Logging?		
No		
Yes		
Back	Home	

- [Yes]: Data logging starts.
- [No]: Data logging will not start.

If the drive was logging data when you entered the command, the keypad look like this:

- Long-term data log:
 - Start time of the data log
 - Elapsed time of the data log

10:00 am	FWD	Tools
End Data Logging?		
No		
Yes		
Start Time : 2016/01/01 00:00		
Period : 00:10:00		
Back	Home	

- Short-term data log:
 - Data log start time or trigger detection time
 - Trigger detection count and the log processing status (Sampling or Recording)

10:00 am	FWD	Tools
End Data Logging?		
No		
Yes		
Triggered : 2016/01/01 00:00		
Short Log : 1/Sampling		
Back	Home	

◆ Configuring the Data Log Content

■ Set Type of Data Log

The procedure in this section shows how to set the type of data log.

1. Push **F2** (Home) to show the HOME screen.







Note:

- When the drive is in HOME Mode, the screen shows [Home] in the upper right-hand corner of the screen.
- If the screen does not show [Home] for **F2**, push **F1** (Back) and then push **F2** to show [Home].

2. Push **F2** (Menu).

10:00 am	FWD	Rdy	Home
Freq Reference (AI)			
U1-01	Hz	0.00	
Output Frequency			
U1-02	Hz	0.00	
Output Current			
U1-03	A	0.00	
Menu			

3. Push  or  to select [Diagnostic Tools], then push .



10:00 am	FWD	Menu
	User Custom Parameters	
	Parameter Backup/Restore	
	Modified Param / Fault Log	
	Auto-Tuning	
	Initial Setup	
	Diagnostic Tools	
Home		

4. Push  or  to select [Data Logger], then push **F3** (Setup).

10:00 am	FWD	Tools
Data Logger		
Backlight		
Drive Information		
Back	Home	Setup

5. Push  or  to select [Log Type], then push .

10:00 am	FWD	Setup
Log Type		
Log Sampling Interval		
Log Monitor		
Back	Home	

6. Push  or  to select the type of data log, then push .

10:00 am	FWD	Parameters
Log Type		
o5-00	1	
Short Term Log		
Default : 0		
Back	Default	

The procedure to set the type of data log is complete.

■ Set the Sampling Time

The procedure in this section shows how to set the sampling time for data logging.

1. Push **F2** (Home) to show the HOME screen.







Note:

- When the drive is in HOME Mode, the screen shows [Home] in the upper right-hand corner of the screen.
- If the screen does not show [Home] for **F2**, push **F1** (Back) and then push **F2** to show [Home].

2. Push **F2** (Menu).



10:00 am FWD Rdy	Home
Freq Reference (AI)	0.00
U1-01 Hz	0.00
Output Frequency	0.00
U1-02 Hz	0.00
Output Current	0.00
U1-03 A	0.00
Menu	

3. Push  or  to select [Diagnostic Tools], then push .

10:00 am FWD	Menu
 User Custom Parameters	
 Parameter Backup/Restore	
 Modified Param / Fault Log	
 Auto-Tuning	
 Initial Setup	
 Diagnostic Tools	
Home	

4. Push  or  to select [Data Logger], then push **F3** (Setup).

10:00 am FWD	Tools
Data Logger	
Backlight	
Drive Information	
Back Home Setup	

5. Push  or  to select [Trend Log Sampling Selection], then push .

10:00 am FWD	Setup
Log Type	
Log Sampling Interval	
Log Monitor	
Back Home	

6. Push  or  then push  or  to change the value.

10:00 am FWD	Parameters
Log Sampling Interval	
o5-02	01000 ms
Default : 1000ms	
Range : 100~60000	
Back Default Min/Max	

Note:

The available sampling times are different for different data log types.

7. After you change the value, push .

10:00 am	FWD	Parameters
Log Sampling Interval		
05-02	20000	ms
Default : 1000ms		
Range : 100~60000		
Back	Default	Min/Max

The procedure to set the sampling time is complete.

■ Set the Sampling Time for a Trend Log



The procedure in this section shows how to set the sampling time for a trend log. When a trend log is set, it works concurrently with the short-term data log to save the data before the trigger is detected.

Note:

This setting is displayed only when short-term data log is selected for the data log type.

1. Push  (Home) to show the HOME screen.







Note:

- The keypad will show [Home] in the top right corner when the HOME screen is active.
- If [Home] is not shown on , push  (Back) to show [Home] on .

2. Push  (Menu).



10:00 am	FWD	Rdy	Home
Freq Reference (AI)			
U1-01	Hz		0.00
Output Frequency			
U1-02	Hz		0.00
Output Current			
U1-03	A		0.00
Menu			

3. Push  or  to select [Diagnostic Tools], then push .



10:00 am	FWD	Menu
	User Custom Parameters	
	Parameter Backup/Restore	
	Modified Param / Fault Log	
	Auto-Tuning	
	Initial Setup	
	Diagnostic Tools	
Home		

4. Push  or  to select [Data Logger], then push  (Setup).

10:00 am	FWD	Tools
Data Logger		
Backlight		
Drive Information		
Back Home Setup		

5. Push  or  to select [Trend Log Sampling Selection], then push .

10:00 am	FWD	Setup
Log Type		
Log Sampling Interval		
Trend Log Sampling Selection		
Log Monitor		
Log Trigger		
Back Home		

6. Push  or  to select the sampling time for the trend log, then push .

10:00 am FWD	Parameters
Trend Log Sampling Selection	
05-21	1
0.1 s (About 1 hour)	
Default : 0	
Back	Default



The procedure to set the sampling time for the trend log is complete.

■ Set Monitor to Log

The procedure in this section shows how to set the monitor for which to log data.

1. Push  (Home) to show the HOME screen.

Note:

- When the drive is in HOME Mode, the screen shows [Home] in the upper right-hand corner of the screen.
- If the screen does not show [Home] for , push  (Back), and then push  to show [Home].

2. Push  (Menu).

10:00 am FWD Rdy	Home
Freq Reference (AI)	
U1-01 Hz	0.00
Output Frequency	
U1-02 Hz	0.00
Output Current	
U1-03 A	0.00
Menu	

3. Push  or  to select [Diagnostic Tools], then push .

10:00 am FWD	Menu
User Custom Parameters	
Parameter Backup/Restore	
Modified Param / Fault Log	
Auto-Tuning	
Initial Setup	
Diagnostic Tools	
Home	

4. Push  or  to select [Data Logger], then push  (Setup).

10:00 am FWD	Tools
Data Logger	
Backlight	
Drive Information	
Back	Home Setup

5. Push  or  to select [Log Monitor], then push .

10:00 am FWD	Setup
Log Monitor	
Log Sampling Interval	
Back	Home

6. Push  or  to select the save-destination monitor parameter, then push .

10:00 am FWD	Setup
Log Monitor	
Log Monitor Data 1	
05-03	101 (101)
Log Monitor Data 2	
05-04	102 (102)
Back	Home

7. Push  or  to select the monitor number to be logged, then push .

10:00 am	FWD	Parameters
Log Monitor Data 1		
05-03		101
Frequency Reference		
Default : 101		
Back	Default	

The configuration procedure is complete.

■ Set the Trigger



The procedure in this section shows how to set the trigger for data logging.

Note:

This setting is available only when you select short-term data log as the data log type.

1. Push  (HOME) to show the HOME screen.







Note:

- When the drive is in HOME Mode, the screen shows [Home] in the upper right-hand corner of the screen.
- If the screen does not show [Home] for , push  (Back) and then push  to show [Home].

2. Push  (Menu).

10:00 am	FWD	Rdy	Home
Freq Reference (AI)			
U1-01	Hz		0.00
Output Frequency			
U1-02	Hz		0.00
Output Current			
U1-03	A		0.00
Menu			

3. Push  or  to select [Diagnostic Tools], then push .



10:00 am	FWD	Menu
	User Custom Parameters	
	Parameter Backup/Restore	
	Modified Param / Fault Log	
	Auto-Tuning	
	Initial Setup	
	Diagnostic Tools	
Home		

4. Push  or  to select [Data Logger], then push  (Setup).



10:00 am	FWD	Tools
Data Logger		
Backlight		
Drive Information		
Back	Home	Setup

5. Push  or  to select [Log Trigger], then push .

10:00 am	FWD	Setup
Log Type		
Log Sampling Interval		
Trend Log Sampling Selection		
Log Monitor		
Log Trigger		
Back	Home	

6. Push  or  to select [Trigger Type Selection], then push .



10:00 am	FWD	Setup
Trigger Type Selection ▶		
Trigger Object		
Trigger Condition		
Pre-Trigger Setting		
Back	Home	

7. Push  or  to select the type of trigger, then push .



10:00 am	FWD	Parameters
Trigger Type Selection		
o5-15	0	
Digital Trigger		
Default : 0		
Back	Default	

Note:

There are no detection width or detection time settings for the analog trigger in the data log function. If variations in the analog signal are a problem, select the digital trigger and use o5-16 = 66/67 [Digital Trigger Object = Comparator 1/2]. Use H2-20 [Comparator 1 Monitor Selection] to H2-32 [Comparator 1 Filter Time] to set the conditions for the comparator function.

8. Push  or  to select [Trigger Object], then push .

10:00 am	FWD	Setup
Trigger Type Selection		
Trigger Object ▶		
Trigger Condition		
Pre-Trigger Setting		
Back	Home	

9. Push  or  to select the trigger target, then push .



10:00 am	FWD	Parameters
Digital Trigger Object		
o5-16	E	
Fault		
Default : E		
Back	Default	

Note:

If analog trigger is the trigger type, set the trigger target and trigger level.

10. Push  or  to select [Trigger Condition], then push .

10:00 am	FWD	Setup
Trigger Type Selection		
Trigger Object		
Trigger Condition ▶		
Pre-Trigger Setting		
Back	Home	

11. Push  or  to select the trigger detections, then push .

10:00 am	FWD	Parameters
Trigger Condition		
o5-19	0	
Rising Edge		
Default : 0		
Back	Default	

12. Push  or  to select [Pre-Trigger Setting], then push .

10:00 am FWD	Setup
Trigger Type Selection	
Trigger Object	
Trigger Condition	
Pre-Trigger Setting ▶	
Back	Home

13. Push  or  then push  or  to change the value.

10:00 am FWD	Parameters
Pre-Trigger Setting	
o5-20	
090 %	
Default : 90%	
Range : 0-100	
Back	Default Min/Max

14. After you change the value, push .

10:00 am FWD	Parameters
Pre-Trigger Setting	
o5-20	
070 %	
Default : 90%	
Range : 0-100	
Back	Default Min/Max



The procedure to set the trigger is complete.

◆ Set Backlight to Automatically Turn OFF

You can set the backlight of the keypad screen to automatically turn OFF after a set length of time since the last key operation on the keypad. The procedure in this section shows how to turn ON and turn OFF the backlight.

1. Push  (Home) to show the HOME screen.

Note:

- The keypad will show [Home] in the top right corner when the HOME screen is active.
- If [Home] is not shown on , push  (Back) to show [Home] on .

2. Push  (Menu).

10:00 am FWD Rdy	Home
Freq Reference (AI)	
U1-01 Hz	0.00
Output Frequency	
U1-02 Hz	0.00
Output Current	
U1-03 A	0.00
Menu	

3. Push  or  to select [Diagnostic Tools], then push .

10:00 am FWD	Menu
User Custom Parameters	
Parameter Backup/Restore	
Modified Param / Fault Log	
Auto-Tuning	
Initial Setup	
Diagnostic Tools ▶	
Home	

4. Push  or  to select [Backlight], then push .

10:00 am FWD	Tools
Data Logger	
Backlight	
Drive Information	
Back	Home Setup

5. Push  or  to select [ON] or [OFF], then push .

10:00 am FWD	Tools
LCD backlight ON/OFF Selection	
OFF	
ON	
Back	Home





- [ON]: Backlight is always ON
- [OFF]: Backlight turns OFF after set length of time.

6. Push  (Setup).

10:00 am FWD	Tools
Data Logger	
Backlight	
Drive Information	
Back	Home Setup

7. Push .

10:00 am FWD	Setup
Energy Saving	
LCD Backlight Off-Delay	
01-38	60 (60)sec
Back	Home

8. Push  or  to select the digit, then push  or  to change the value.

10:00 am FWD	Parameters
LCD Backlight Off-Delay	
01-38	
	060 sec
Default : 60sec	
Range : 10~300	
Back	Default Min/Max

9. When you are done changing the value, push .

10:00 am FWD	Parameters
LCD Backlight Off-Delay	
01-38	
	030 sec
Default : 60sec	
Range : 10~300	
Back	Default Min/Max

The procedure to set the backlight to turn OFF automatically is complete.

◆ Show Information about the Drive

The procedure in this section shows how to show the drive model, maximum applicable motor output (HD/ND), rated output current (HD/ND), software version, and the serial number on the keypad.

1. Push **F2** [Home] to show the HOME screen.







Note:

- The keypad will [Home] in the top right corner when the HOME screen is active.
- If [Home] is not shown on **F2**, push **F1** [Back] to show [Home] on **F2**.

2. Push **F2** [Menu].

10:00 am	FWD	Rdy	Home
Freq Reference (AI)			0.00
U1-01	Hz		0.00
Output Frequency			0.00
U1-02	Hz		0.00
Output Current			0.00
U1-03	A		0.00
Menu			

3. Push  or  to select [Diagnostic Tools], then push .

10:00 am	FWD	Menu
	User Custom Parameters	
	Parameter Backup/Restore	
	Modified Param / Fault Log	
	Auto-Tuning	
	Initial Setup	
	Diagnostic Tools	▶
Home		

4. Push  or  to select [Drive Information], then push .

10:00 am	FWD	Tools
Data Logger		
Backlight		
Drive Information ▶		
Back Home		

The keypad will show the drive information.

10:00 am	FWD	Tools
GA700		
200v, 22.0/30.0kw		
88.00/110.0A		
<VSAA01010>		
S/N: J0065F575310100		
Back Home		

A - Drive Series

B - Maximum Applicable Motor Output (HD/ND)

C - Rated Output Current (HD/ND)

D - Drive software version

E - Serial number

◆ Show Information about the Communication Option

When you install a JOHB-SMP3, Multi-protocol EtherNet option, the keypad can show information about the option.

1. Push **F2** (Home) to show the HOME screen.

Note:

- The keypad will [Home] in the top right corner when the HOME screen is active.
- If [Home] is not shown on **F2**, push **F1** (Back) to show [Home] on **F2**.

2. Push **F2** (Menu).

10:00 am	FWD	Rdy	Home
Freq Reference (AI)			0.00
U1-01	Hz		0.00
Output Frequency			0.00
U1-02	Hz		0.00
Output Current			0.00
U1-03	A		0.00
Menu			

3. Push or to select [Diagnostic Tools], then push .

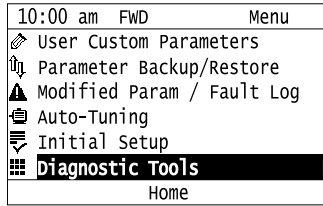

4. Push or to select [Comm. Option Information], then push .

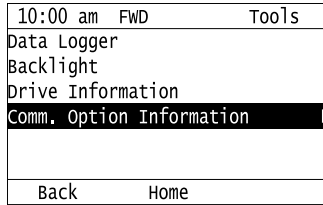

The keypad shows the selected monitor as shown in this example figure.

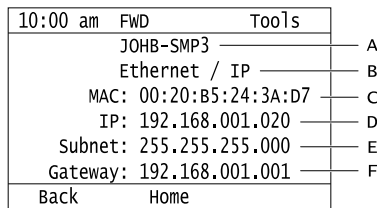

Symbol	Name	Description
A	Station Name	PROFINET protocol shows the station name. All other protocols show "JOHB-SMP3". Note: With PROFINET, the screen shows the station name set on the PLC. If you do not set the station name, the screen shows "No Station Name".
B	Protocol	Shows the protocol set using the DIP switches on the JOHB-SMP3 option.
C	MAC Address	Shows the main MAC address of the JOHB-SMP3 option. Shows the same content as U4-76 to U4-78.
D	IP Address	Shows the IP (Internet Protocol) address assigned to the JOHB-SMP3 option. Shows the same content as U6-80 to U6-83. If there is no IP address assigned to the JOHB-SMP3 option, this will show "000.000.000.000".
E	Subnet Mask	Shows the subnet mask assigned to the JOHB-SMP3 option. Shows the same content as U6-84 to U6-87. If there is no subnet mask assigned to the JOHB-SMP3 option, this will show "000.000.000.000".
F	Gateway Address	Shows the gateway address assigned to the JOHB-SMP3 option. Shows the same content as U6-88 to U6-91. If there is no gateway address assigned to the JOHB-SMP3 option, this will show "000.000.000.000".

◆ Write Automatically Backed-up Parameters to the Drive



You can automatically back up parameters to the keypad connected to the drive and write those parameters to a drive from the same drive series as specified by the settings of o3-06 [Auto Parameter Backup Selection] and o3-07 [Auto Parameter Backup Interval].

Note:

- Set o3-06 = 1 [Auto Parameter Backup Selection = Enabled] in each drive to which you will write the parameters.
- This operation is not available when the parameters in the keypad and the parameters on the other drives are set to the same values.

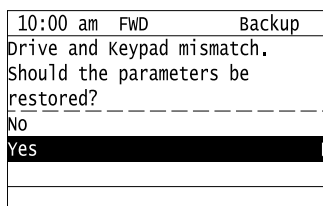
1. Connect the keypad to the drive.
2. Push or to select [Yes], then push .



3. Push  or  to select [Yes], then push .

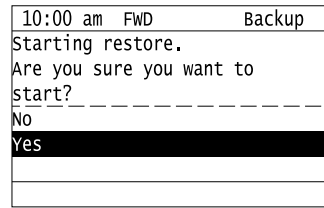

The keypad will show the "End" message when the write process is complete.

4.7 Automatic Parameter Settings Optimized for Specific Applications (Application Presets)

The drive has application presets to set the necessary parameters for different applications to their best values. Use *A1-06* from [User Custom Parameters] on the Main menu to check the parameters that were automatically changed by the application preset function.

Note:

Make sure that you set *A1-03* = 2220, 3330 [Initialize Parameters = 2-Wire Initialization, 3-Wire Initialization] to initialize parameters before you set *A1-06*.

This section shows the procedure to set an application preset.

1. Push **F2** (Home) to show the HOME screen.

Note:



- The keypad will show [Home] in the top right corner when the HOME screen is active.
- If [Home] is not shown on **F2**, push **F1** (Back) to show [Home] on **F2**.

2. Push **F2** (Menu).



10:00 am	FWD	Rdy	Home
Freq Reference (AI)			
U1-01	Hz		0.00
Output Frequency			
U1-02	Hz		0.00
Output Current			
U1-03	A		0.00
Menu			

3. Push  or  to select [Parameters], then push .



10:00 am	FWD		Menu
Monitors			
Parameters			
User Custom Parameters			
Parameter Backup/Restore			
Modified Param / Fault Log			
Auto-Tuning			
Home			

4. Push  or  to select [A Initialization Parameters], then push .

10:00 am	FWD		Parameters
A Initialization Parameters			
b Application			
C Tuning			
d References			
E Motor Parameters			
F Options			
Back		Home	

5. Push  or  to select [A1 Initialization], then push .

10:00 am	FWD		Parameters
A1 Initialization			
A2 User Parameters			
Back		Home	

6. Push  or  to select *A1-06*, then push .

10:00 am	FWD		Parameters
Password			
A1-04	0		(0)
Application Preset			
A1-06	1		(0)
DriveWorksEZ Function Selection			
A1-07	0		(0)
Back		Home	

7. Push  or  to change the value, then push .

10:00 am FWD	Parameters
Application Preset	
A1-06	3
Exhaust fan	
Default : 0	
Back	Default

The parameter setting procedure is complete.

Note:

- For hoist applications, make sure that you do Auto-Tuning after you set *A1-06*.
- You cannot change the value set in *A1-06*. To select an application preset, first set *A1-03* = 2220 to initialize parameters and then make a selection to *A1-06*. If initializing all parameters will cause a problem, it is not necessary to change settings.
- When the drive changes to the *A1-06* setting, it will also reset the parameters automatically registered to *A2-17* to *A2-32* [*User Parameters 17 to 32*] when *A2-33* = 1 [*User Parameter Auto Selection = Enabled: Auto Save Recent Params*].

4.8 Auto-Tuning

Auto-Tuning uses motor characteristics to automatically set drive parameters for vector control. Think about the type of motor, drive control method, and the motor installation environment and select the best Auto-Tuning method.

The keypad will show the messages with prompts to input the necessary parameter information. These prompts are specified by the selected Auto-Tuning method and the control method setting in *A1-02*.

◆ Auto-Tuning for Induction Motors

This section gives information about Auto-Tuning for induction motors. Auto-Tuning sets these parameters:

- Motor parameters *E1-xx*, *E2-xx* (*E3-xx*, *E4-xx* for motor 2)
- Speed feedback detection-use *F1-xx* (only with CLV)

Note:

Do Stationary Auto-Tuning if you cannot do Rotational Auto-Tuning. There can be large differences between the measured results and the motor characteristics when Auto-Tuning is complete. Examine the parameters for the measured motor characteristics after you do Stationary Auto-Tuning.

Table 4.6 Types of Auto-Tuning for Induction Motors

Mode	Parameter Settings	Application Conditions and Benefits	Applicable Control Method (A1-02 Setting)				
			V/f (0)	CL-V/f (1)	OLV (2)	CLV (3)	AOLV (4)
Rotational Auto-Tuning	T1-01 = 0	<ul style="list-style-type: none"> • When you can decouple the motor and load the motor can rotate freely while Auto-Tuning. • When operating motors that have fixed output characteristics. • When it is necessary to use motors that have high-precision control. • When you cannot decouple the motor and load, but the motor load is less than 30%. 	x	x	x	x	x
Stationary Auto-Tuning 1	T1-01 = 1	<ul style="list-style-type: none"> • When you cannot decouple the motor and load, but the motor load is more than 30%. • When the information from the motor test report or motor nameplate is not available. With Stationary Auto-Tuning, the energized drive stays stopped for approximately 1 minute. During this time, the drive automatically measures the necessary motor parameters. • When operating the motor with a light load after Auto-Tuning. The drive can automatically calculate the motor parameter settings necessary for torque control. Set <i>T1-12 = 1</i> [<i>Test Mode Selection = Yes</i>] to do a test run after Auto-Tuning. 	-	-	x	x	x
Line-to-Line Resistance	T1-01 = 2	<ul style="list-style-type: none"> • After Auto-Tuning, the wiring distance between the drive and motor changed by 50 m or more. • When the wiring distance is 50 m or more in the V/f Control mode. • When the motor output and drive capacity are different. 	x	x	x	x	x

■ Input Data for Induction Motor Auto-Tuning

To do Auto-Tuning, input data for the items in [Table 4.7](#) that have an "x". Before starting Auto-Tuning, prepare the motor test report or record the information on the motor nameplate as a reference.

Table 4.7 Input Data for Induction Motor Auto-Tuning

Input Data	Parameter	Unit	Auto-Tuning Mode (T1-01 Setting)		
			Rotational Auto-Tuning (0)	Stationary Auto-Tuning 1 (1)	Line-to-Line Resistance (2)
Motor Rated Power	T1-02	kW	x	x	x
Motor Rated Voltage	T1-03	V	x	x	-
Motor Rated Current	T1-04	A	x	x	x
Motor Base Frequency	T1-05	Hz	x	x	-
Number of Motor Poles	T1-06	-	x	x	-

Input Data	Parameter	Unit	Auto-Tuning Mode (T1-01 Setting)		
			Rotational Auto-Tuning (0)	Stationary Auto-Tuning 1 (1)	Line-to-Line Resistance (2)
Motor Base Speed	T1-07	min ⁻¹	x	x	-
Encoder Pulse Count (PPR)	T1-08	-	o *1	o *1	-
Motor No-Load Current	T1-09	A	-	x	-
Motor Rated Slip Frequency	T1-10	Hz	-	o *2	-
Motor Iron Loss	T1-11	W	o *3	-	-
Test Mode Selection *4	T1-12	-	-	o *5	-
No-load voltage	T1-13	V	o *6	o *6	-

- *1 Input this value when A1-02 = 3 [Control Method Selection = Closed Loop Vector].
- *2 Shows 0 Hz as the default value. If you do not know the Motor Rated Slip Frequency, keep the setting at 0 Hz.
- *3 Input this value when A1-02 = 0 or 1 [Control Method Selection = V/f Control or V/f Control w/ PG].
- *4 If T1-12 = 1 [Test Mode Selection = Yes], when you run the motor in Drive Mode for the first time after Auto-Tuning, the drive will automatically set E2-02 [Motor Rated Slip] and E2-03 [Motor No-Load Current].
- *5 Input this value when T1-10 [Motor Rated Slip Frequency] = 0 Hz.
- *6 Set the same value to No-Load Voltage as T1-03 [Motor Rated Voltage] to get the same characteristics using Yaskawa 1000-Series drives or other legacy models.

◆ Auto-Tuning for PM Motors

This section gives information about Auto-Tuning for PM motors. Auto-Tuning sets these parameters:

- Motor parameters E1-xx, E5-xx
- Speed feedback detection uses F1-xx (only with CLV/PM)

Table 4.8 Auto-Tuning for PM Motors

Mode	Parameter Settings	Application Conditions and Benefits	Applicable Control Method (A1-02 Setting)		
			OLV/PM (5)	AOLV/PM (6)	CLV/PM (7)
Manual Entry w/ Motor Data Sheet	T2-01 = 0	<ul style="list-style-type: none"> • When the information from the motor test report or motor nameplate is available. • Rotational/Stationary Auto-Tuning that energizes the motor is not done. Manually input the necessary motor parameters. 	x	x	x
PM Stationary Auto-Tuning	T2-01 = 1	<ul style="list-style-type: none"> • When the information from the motor test report or motor nameplate is not available. Note: With Stationary Auto-Tuning, the energized drive stays stopped for approximately 1 minute. During this time, the drive automatically measures the necessary motor parameters. 	x	x	x
PM Stationary Auto-Tuning for Stator Resistance	T2-01 = 2	<ul style="list-style-type: none"> • After Auto-Tuning, the wiring distance between the drive and motor changed by 50 m (164 ft) or more. • When the motor output and drive capacity are different. 	x	x	x
Z-Pulse Offset (Pole Position)	T2-01 = 3	<ul style="list-style-type: none"> • When you do not know the encoder Z-pulse offset. • When the encoder was replaced • If you have compensated for the deviation from Z phase ($\Delta\theta$). Note: The motor will rotate slowly while the drive measures the encoder base position. 	-	-	x

Mode	Parameter Settings	Application Conditions and Benefits	Applicable Control Method (A1-02 Setting)		
			OLV/PM (5)	AOLV/PM (6)	CLV/PM (7)
Rotational (Ld, Lq, R, back-EMF)	T2-01 = 4	<ul style="list-style-type: none"> When the information from the motor test report or motor nameplate is not available. When you can decouple the motor and load and the motor can rotate freely while Auto-Tuning. The drive will automatically set the values measured during Auto-Tuning to the motor parameters. 	x	x	x
High Frequency Injection	T2-01 = 5	<ul style="list-style-type: none"> Automatically sets the control parameters that are necessary to set $n8-35 = 1$ [Initial Pole Detection Method = High Frequency Injection] or $n8-57 = 1$ [HFI Overlap Selection = Enabled]. Applicable to IPM motors only. Do Auto-Tuning with the motor connected to the drive. <p>Note: When you set $n8-35 = 1$ or $n8-57 = 1$, do High Frequency Injection Auto-Tuning. Set the data on the motor nameplate to the drive before you do High Frequency Injection Auto-Tuning. In High Frequency Injection Auto-Tuning, the drive energizes the stopped motor and automatically adjusts the parameters.</p>	x	x	x

■ Input Data for PM Motor Auto-Tuning

To do Auto-Tuning, input data for the items in Table 4.9 and Table 4.10 that have an "x". Before you start Auto-Tuning, prepare the motor test report or record the information from the motor nameplate as a reference.

Table 4.9 Input Data for PM Motor Auto-Tuning

Input Data	Parameter	Unit	Auto-Tuning Mode (T2-01 Setting)					
			Manual Entry w/ Motor Data Sheet (0)			PM Stationary Auto-Tuning (1)		PM Stationary Auto-Tuning for Stator Resistance (2)
Control Method Selection	A1-02	-	5, 6, 7	5	6, 7	5	6, 7	5, 6, 7
PM Motor Code Selection	T2-02	-	Motor code of Yaskawa motor *1	FFFF *2	FFFF *2	-	-	-
PM Motor Type	T2-03	-	-	-	-	x	x	-
PM Motor Rated Power	T2-04	kW	-	x	x	x	x	-
PM Motor Rated Voltage	T2-05	V	-	x	x	x	x	-
PM Motor Rated Current	T2-06	A	-	x	x	x	x	x
PM Motor Base Frequency	T2-07	Hz	-	x	-	x	-	-
Number of PM Motor Poles	T2-08	-	-	x	x	x	x	-
PM Motor Base Speed	T2-09	min ⁻¹	-	-	x	-	x	-
PM Motor Stator Resistance	T2-10	Ω/mΩ	x	x	x	-	-	-
PM Motor d-Axis Inductance	T2-11	mH	x	x	x	-	-	-
PM Motor q-Axis Inductance	T2-12	mH	x	x	x	-	-	-
Back-EMF Units Selection	T2-13	-	x	x	x	-	-	-
Back-EMF Voltage Constant (Ke)	T2-14	*3	x	x	x	-	-	-
Pull-In Current Level	T2-15	%	-	-	-	x	x	-
Encoder Pulse Count (PPR)	T2-16	-	*4	-	*4	-	*4	-
Encoder Z-Pulse Offset for PM Motor	T2-17	Degrees	*4	-	*4	-	*4	-

*1 Set the motor code for a Yaskawa PM motor.
 *2 Set the motor code to FFFF for a PM motor from a different manufacturer.
 *3 Changes when the value set in T2-13 changes.
 *4 Input this value when A1-02 = 7 [Control Method Selection = PM Closed Loop Vector Control].

Table 4.10 Input Data for PM Motor Auto-Tuning

Input Data	Parameter	Unit	Auto-Tuning Mode (T2-01 Setting)				
			Z-Pulse Offset (Pole Position) (3)	Rotational (Ld, Lq, R, back-EMF) (4)			High Frequency Injection (5)
Control Method Selection	A1-02	-	7	5	6	7	5, 6, 7
PM Motor Code Selection	T2-02	-	-	-	-	-	-
PM Motor Type	T2-03	-	-	x	x	x	-
PM Motor Rated Power	T2-04	kW	-	x	x	x	-
PM Motor Rated Voltage	T2-05	V	-	x	x	x	-
PM Motor Rated Current	T2-06	A	-	x	x	x	-
PM Motor Base Frequency	T2-07	Hz	-	x	-	-	-
Number of PM Motor Poles	T2-08	-	-	x	x	x	-
PM Motor Base Speed	T2-09	min ⁻¹	-	-	x	x	-
PM Motor Stator Resistance	T2-10	Ω/mΩ	-	-	-	-	-
PM Motor d-Axis Inductance	T2-11	mH	-	-	-	-	-
PM Motor q-Axis Inductance	T2-12	mH	-	-	-	-	-
Back-EMF Units Selection	T2-13	-	-	-	-	-	-
Back-EMF Voltage Constant (Ke)	T2-14	<i>*1</i>	-	-	-	-	-
Pull-In Current Level	T2-15	%	-	x	x	x	-
Encoder Pulse Count (PPR)	T2-16	-	-	-	-	x	-
Encoder Z-Pulse Offset for PM Motor	T2-17	Degrees	-	-	-	-	-

*1 Changes when the value set in T2-13 changes.

◆ Auto-Tuning in EZ Open Loop Vector Control Method

This section gives information about the Auto-Tuning mode for EZ Open Loop Vector Control. Auto-Tuning will set the *E9-xx* parameters.

Table 4.11 EZ Tuning Mode Selection

Mode	Parameter Settings	Application Conditions and Benefits	Applicable Control Method (A1-02 Setting)
Motor Parameter Setting	T4-01 = 0	<ul style="list-style-type: none"> Applicable when driving an induction motor or a PM motor Suitable for derating torque applications, for example fans and pumps. 	EZOLV (8)
Line-to-Line Resistance	T4-01 = 1	<ul style="list-style-type: none"> After Auto-Tuning, the wiring distance between the drive and motor changed by 50 m or more. When the motor output and drive capacity are different. 	EZOLV (8)

■ Auto-Tuning Input Data in EZ Open Loop Vector Control Method

To do Auto-Tuning, input data for the items in Table 4.12 that have an "x". Before you start Auto-Tuning, prepare the motor test report or record the information from the motor nameplate as a reference.

Table 4.12 Auto-Tuning Input Data in EZ Open Loop Vector Control Method

Input Data	Parameter	Unit	Auto-Tuning Mode (T4-01 Setting)	
			Motor Parameter Setting (0)	Line-to-Line Resistance (1)
Motor Type Selection	T4-02	-	x	-
Motor Max Revolutions	T4-03	min ⁻¹	x	-

4.8 Auto-Tuning

Input Data	Parameter	Unit	Auto-Tuning Mode (T4-01 Setting)	
			Motor Parameter Setting (0)	Line-to-Line Resistance (1)
Motor Rated Revolutions	T4-04	min ⁻¹	x	-
Motor Rated Frequency	T4-05	Hz	x	-
Motor Rated Voltage	T4-06	V	x	-
Motor Rated Current (FLA)	T4-07	A	x	x
PM Motor Rated Power (kW)	T4-08	kW	x	x
Number of Motor Poles	T4-09	-	x	-

◆ Control Tuning

To increase drive responsiveness and prevent hunting, use Auto-Tuning to automatically adjust the control-related parameters.

These types of Auto-Tuning are available for the control system:

- Inertia Tuning
- ASR Tuning
- Deceleration Rate Tuning
- KEB Tuning

Note:

If you do Control Tuning, you cannot set $H1-xx = 16$ [Motor 2 Selection]. Do not do Control Tuning for applications that switch between motor 1 and motor 2.

Table 4.13 Control Loop Tuning Selection

Mode	T3-00	Application Conditions and Benefits	Applicable Control Method (A1-02 Value)								
			V/f (0)	CL-V/f (1)	OLV (2)	CLV (3)	AOLV (4)	OLV/PM (5)	AOLV/ PM (6)	CLV/PM (7)	EZOLV (8)
Inertia Tuning	0	<ul style="list-style-type: none"> • For Feed Forward Control • When $L2-29 = 1$ [Kinetic Energy Backup Method = Single Drive KEB Ride-Thru 2]. • When MFDI $H1-xx = 7A$ [KEB Ride-Thru 2 Activate (N.C.)]. 	-	-	-	x	-	-	-	x	-
ASR Tuning	1	To let the set response frequency (including Inertia Tuning) automatically adjust the ASR gain.	-	-	-	x	-	-	-	x	-
Deceleration Rate Tuning	2	To automatically adjust the deceleration rate to prevent an <i>ov</i> [Overvoltage] fault.	x	x	x	x	x	x	x	x	x
KEB Tuning	3	<ul style="list-style-type: none"> • To automatically adjust parameter settings to prevent an <i>ov</i> [Overvoltage] fault with the KEB Ride-Thru function. • When $L3-11 = 1$ [Overvoltage Suppression Select = Enabled]. 	x	x	x	x	x	x	x	x	x

Table 4.14 Input Data for Control Tuning

Input Data	Parameters	Unit	Auto-Tuning Mode (T3-00 Value)			
			Inertia Tuning (0)	ASR (Speed Regulator) (1)	Dec Rate Tuning (2)	KEB Tuning (3)
Test Signal Frequency	T3-01	Hz	x	x	-	-
Test Signal Amplitude	T3-02	Rad	x	x	-	-
Motor Inertia	T3-03	Kg·m ²	x	x	-	-
System Response Frequency	T3-04	Hz	-	x	-	-

■ Inertia Tuning

Inertia Tuning uses the motor speed and torque reference to estimate the system inertia and automatically sets the drive parameters related to the inertia ratio of the machinery and motor. Use Inertia Tuning for Feed Forward control or when $H1-xx = 7A$ [*MFDI Function Select = KEB Ride-Thru 2 Activate (N.C.)*].

Inertia tuning identifies the load inertia and optimizes the speed loop gain and feed forward gain to get a high level of control capability. You can set the speed response without thinking about the load, which increases the precision when synchronizing multiple drives. Since the motor can continue to operate during a power outage, Inertia Tuning keeps the best ramp to stop deceleration curve for KEB Ride-Thru.

■ ASR Tuning

ASR Tuning estimates the motor load inertia and automatically sets the parameters. ASR Tuning also uses the measured load inertia value to do an automatic adjustment after calculating the proportional gain of speed control (ASR).

■ Deceleration Rate Tuning

Deceleration Rate Tuning automatically sets the deceleration rate to prevent an *ov* [*Overvoltage*] fault during motor deceleration. Set *C1-11* [*Accel/Decel Time Switchover Freq*] first to automatically set parameters *C1-02* [*Deceleration Time 1*] (high speed range) and *C1-08* [*Deceleration Time 4*] (low speed range).

■ KEB Tuning

KEB Tuning automatically sets parameters used for the KEB Ride-Thru function and for the overvoltage suppression function.

Control Tuning automatically sets the parameters in [Table 4.15](#) to the best values.

Table 4.15 Parameters set in Control Tuning

Parameters Automatically Set	Inertia Tuning	ASR Tuning	Deceleration Rate Tuning	KEB Tuning
C1-02 [Deceleration Time 1]	-	-	x	-
C1-08 [Deceleration Time 4]	-	-	x ^{*1}	-
C1-09 [Fast Stop Time]	-	-	-	x ^{*2}
C5-01 [ASR Proportional Gain 1]	-	x	-	-
C5-17 [Motor Inertia]	x	x	-	-
C5-37 [Motor 2 Inertia]	x	x	-	-
C5-18 [Load Inertia Ratio]	x	x	-	-
C5-38 [Motor 2 Load Inertia Ratio]	x	x	-	-
L2-06 [Kinetic Energy Backup Decel Time]	-	-	-	x ^{*3}
L3-24 [Motor Accel Time @ Rated Torque]	x	x	-	-
L3-25 [Load Inertia Ratio]	x	x	-	x
n5-02 [Motor Inertia Acceleration Time]	x	x	-	-
n5-03 [Feed Forward Control Gain]	x	x	-	-

*1 The drive automatically sets *C1-08* [*Deceleration Time 4*] only when *C1-11* [*Accel/Decel Time Switchover Freq*] $\neq 0$.

*2 When *L2-29* = 0 [*Kinetic Energy Backup Method = Single Drive KEB Ride-Thru 1*], the drive will automatically adjust *C1-09* [*Fast Stop Time*] and will not adjust *L2-06* [*Kinetic Energy Backup Decel Time*]. If the Fast Stop time must not change, do not do KEB Tuning.

*3 When *L2-29* = 1, 2, or 3 [*Kinetic Energy Backup Method = Single Drive KEB Ride-Thru 2, System KEB Ride-Thru 1, or System KEB Ride-Thru 2*], the drive will automatically adjust *L2-06* [*Kinetic Energy Backup Decel Time*].

◆ Precautions before Auto-Tuning

Examine the topics in this section before you start Auto-Tuning.

■ Prepare for Basic Auto-Tuning

- You must input data from the motor nameplate or motor test report to do Auto-Tuning. Make sure that this data is available before you do Auto-Tuning.

4.8 Auto-Tuning

- For best performance, make sure that the drive input supply voltage is equal to or more than the motor rated voltage.

Note:

Better performance is possible when you use a motor with a rated voltage that is less than the input supply voltage (by 20 V for 200 V class models or by 40 V for 400 V class models). This is very important when you operate the motor at more than 90% of base speed, where high torque precision is necessary. If the input power supply is equal to the motor rated voltage, the drive output voltage will not be sufficient and performance will decrease.

- Push  on the keypad to cancel Auto-Tuning.
- If a Safe Disable input signal is input to the drive during Auto-Tuning, Auto-Tuning measurements will not complete successfully. If this occurs, cancel Auto-Tuning, then do it again.
- Table 4.16 shows the status of multi-function input/output terminals during Auto-Tuning.

Table 4.16 Status of Input/Output Terminals during Auto-Tuning

Auto-Tuning Type	Mode		Multi-Function Input	Digital Output
Induction Motor Auto-Tuning	Rotational	Rotational Auto-Tuning	Disabled	Functions the same as during usual operation.
	Stationary	Stationary Auto-Tuning 1	Disabled	Keeps the status at the start of Auto-Tuning.
		Line-to-Line Resistance	Disabled	Keeps the status at the start of Auto-Tuning.
PM Motor Auto-Tuning	Rotational	Z-Pulse Offset (Pole Position)	Disabled	<ul style="list-style-type: none"> PRG: 01028 and earlier: Keeps the status at the start of Auto-Tuning. PRG: 01029 and later: Functions the same as during usual operation.
		Rotational (Ld, Lq, R, back-EMF)	Disabled	Functions the same as during usual operation.
	Stationary	Manual Entry w/ Motor Data Sheet	Disabled	Keeps the status at the start of Auto-Tuning.
		PM Stationary Auto-Tuning	Disabled	Keeps the status at the start of Auto-Tuning.
		PM Stationary Auto-Tuning for Stator Resistance	Disabled	Keeps the status at the start of Auto-Tuning.
EZ Tuning	Stationary	Motor Parameter Setting	Disabled	Keeps the status at the start of Auto-Tuning.
		Line-to-Line Resistance	Disabled	Keeps the status at the start of Auto-Tuning.
ASR and Inertia Tuning	Rotational	Inertia Tuning	Disabled	Functions the same as during usual operation.
		ASR (Speed Regulator)	Disabled	Functions the same as during usual operation.
		Deceleration Rate Tuning	Disabled	Functions the same as during usual operation.
		KEB Tuning	Disabled	Functions the same as during usual operation.

WARNING! Crush Hazard. Wire a sequence that will not let a multi-function output terminal open the holding brake during Stationary Auto-Tuning. If the holding brake is open during Stationary Auto-Tuning, it can cause serious injury or death.

WARNING! Sudden Movement Hazard. Before you do Rotational Auto-Tuning, disconnect the load from the motor. The load can move suddenly and cause serious injury or death.

WARNING! Injury to Personnel. Rotational Auto-Tuning rotates the motor at 50% or more of the motor rated frequency. Make sure that there are no issues related to safety in the area around the drive and motor. Increased motor frequency can cause serious injury or death.

WARNING! Electrical Shock Hazard. During Auto-Tuning, the motor will receive high voltage when the motor is stopped. Do not touch the motor until Auto-Tuning is complete. If you touch a motor that is energized, it can cause serious injury or death.

■ Precautions before Rotational Auto-Tuning

WARNING! Electrical Shock Hazard. During Auto-Tuning, the motor will receive high voltage when the motor is stopped. Do not touch the motor until Auto-Tuning is complete. If you touch a motor that is energized, it can cause serious injury or death.

- Before you do Rotational Auto-Tuning to prevent drive malfunction, uncouple the motor from the load. If you do Rotational Auto-Tuning with the motor connected to a load that is more than 30% of the motor duty rating, the drive will not correctly calculate the motor parameters and the motor can operate incorrectly.
- When the load is 30% or less of the motor duty rating, you can do Auto-Tuning with the motor connected to a load.
- Make sure that the motor magnetic brake is released.

- Make sure that external force from the machine will not cause the motor to rotate.

■ Precautions before Stationary Auto-Tuning

- Make sure that the motor magnetic brake is not open.
- Make sure that external force from the machine will not cause the motor to rotate.

WARNING! *Electrical Shock Hazard. During Auto-Tuning, the motor will receive high voltage when the motor is stopped. Do not touch the motor until Auto-Tuning is complete. If you touch a motor that is energized, it can cause serious injury or death.*

Automatically Set E2-02 [Motor Rated Slip] and E2-03 [Motor No-Load Current]

If $T1-12 = 1$ [Test Mode Selection = Yes] when selecting Stationary Auto-Tuning, the drive will automatically set motor parameters E2-02 [Motor Rated Slip] and E2-03 [Motor No-Load Current] after Auto-Tuning is complete when you use the motor for the first time in Drive Mode.

After Stationary Auto-Tuning is complete, use this procedures to do the operation in test mode:

1. Check the E2-02 and E2-03 values on the “Modified Parameters/Fault Log” screen or the “Parameters” screen.
2. Operate the motor in Drive Mode with these conditions:
 - Make sure that you connect all wiring between the drive and motor
 - Make sure that a mechanical brake on the motor shaft is not locked
 - The maximum motor load must be 30% of the rated load.
 - Keep a constant speed of 30% of E1-06 [Base Frequency] (default value = maximum frequency) or more for 1 second or longer.
3. After the motor stops, check the E2-02 and E2-03 values on the “Modified Parameters/Fault Log” screen or the “Parameters” screen again.
4. Make sure that the input data is correct.
When the settings in E2-02 and E2-03 are different than in step 1, the drive set the values automatically.

Note:

- If you cannot operate the motor with the conditions in step 2 for the first test run and if the values set in E2-02 and E2-03 are much different than data in the official test report for the motor and the data listed in *Defaults by Drive Model and Duty Rating ND/HD on page 637*, these problems can occur:

- Motor vibrations or hunting
- Not sufficient torque
- Overcurrent

In elevator applications, there is a risk of the cage falling and causing personal injury.

Do one of these precautions to decrease the risk:

- After doing Stationary Auto-Tuning, operate the drive as specified by the conditions and procedure above.
- Set $T1-12 = 0$ [Test Mode Selection = No].
- Do Rotational Auto-Tuning.

- If you initialize the drive after completing Step 1, do the procedure beginning from Step 1 again.
- For general-purpose motors, the target value for E2-02 is 1 Hz to 3 Hz, and the target rated current for E2-03 is 30% to 65%. Larger capacity motors have a lower rated slip, and a smaller ratio for the no-load current rated current. Refer to *Defaults by Drive Model and Duty Rating ND/HD on page 637*.

■ Precautions before Stationary Auto-Tuning for Line-to-Line Resistance and Stator Resistance Auto-Tuning

In V/f control, when the motor cable is 50 meters (164 feet) or longer, do Stationary Auto-Tuning for Line-to-Line Resistance.

WARNING! *Electrical Shock Hazard. During Auto-Tuning, the motor will receive high voltage when the motor is stopped. Do not touch the motor until Auto-Tuning is complete. If you touch a motor that is energized, it can cause serious injury or death.*

■ Precautions before Inertia Tuning and ASR Tuning

Before Inertia Tuning or ASR Tuning, check these items:

WARNING! *Electrical Shock Hazard. During Auto-Tuning, the motor will receive high voltage when the motor is stopped. Do not touch the motor until Auto-Tuning is complete. If you touch a motor that is energized, it can cause serious injury or death.*

- Do rotational motor parameter tuning or look at the motor test report or nameplate to enter the values manually.
- Make sure that the motor magnetic brake is released.
- Connect the motor and load.
- Make sure that external force from the machine will not cause the motor to rotate.
- Make sure that the machine does not prevent reverse rotation. You cannot do Inertia Tuning or ASR Tuning with machines that prevent reverse rotation.

- When the motor can rotate during Auto-Tuning, check for safety issues near the drive, motor, and machine.

Note:

If there are gears between the machine and motor shaft, Inertia Tuning or ASR Tuning are possibly not applicable.

■ Precautions before Using Deceleration Rate Tuning and KEB Tuning

Before Deceleration Rate Tuning or KEB Tuning, check these items:

Note:

- Do not do Deceleration Rate Tuning if you use a braking resistor unit or a regenerative converter.
- Do Deceleration Rate Tuning and KEB Tuning with the load attached to the motor.
- Do not do Deceleration Rate Tuning or KEB Tuning for these applications:
In Deceleration Rate Tuning and KEB Tuning, the drive will automatically rotate the motor forward and accelerate and decelerate the motor again and again.
 - On a machine that does not let the motor rotate forward
 - In applications with a small range of operation (trolleys and other such applications that can only move linearly)
 - In elevator applications
 - Applications where sudden acceleration and sudden deceleration are not applicable.
- To do KEB Tuning with the external main circuit capacitors connected to the drive, set L3-26 [*Additional DC Bus Capacitors*] then do KEB Tuning.
- Do not do KEB Tuning or Deceleration Rate Tuning if the drive is set to use H1-xx = 16 [*MFDI Function Select = Motor 2 Selection*]. Failure to obey can cause an ov [*Overvoltage*] fault.

4.9 Test Run

After you use the Setup Wizard to set the basic parameters and Auto-Tune the drive, the next step is to do a test run.

WARNING! Crush Hazard. Test the system to make sure that the drive operates safely after you wire the drive and set parameters. If you do not test the system, it can cause damage to equipment or serious injury or death.

◆ No-Load Test Run

Before connecting the motor to the machine, make sure that you check the operation status of the motor.

■ Precautions before Operation

Before rotating the motor, check these items:

- Check for safety issues near the drive, motor, and machine.
- Make sure that all emergency stop circuits and machine safety mechanisms are operating correctly.

■ Items to Check before Operation

Check these items before operation:

- Is the motor rotating in the forward direction?
- Is the motor rotating smoothly (no unusual sounds or unusual vibrations)?
- Does the motor accelerate/decelerate smoothly?

◆ Do a No-Load Test Run

Do these steps for a no-load test run:

1. Energize the drive, or push **F2** to show the HOME screen.
If [Home] is not shown on **F2**, push **F1** (Back) to show [Home] on **F2**.
2. Push **LO/RE** to illuminate the LOCAL/REMOTE indicator.
3. Push **↺** to show *d1-01 [Reference 1]*, and set it to 6.00 Hz.
4. Push **↻**.
The RUN indicator illuminates, and the motor runs at 6.00 Hz in the forward direction.
5. Make sure that the motor is rotating in the correct direction and that the drive does not show a fault.
If the drive detects a fault, remove the cause.

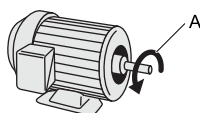

A - Forward Rotation of Motor (Counter Clockwise Direction as Seen from Load Shaft)

6. Push **↻** to increase the frequency reference value.
Change the setting value in increments of 10 Hz if necessary and examine the response.
7. Each time you increase the setting value, use *U1-03 [Output Current]* to check the drive output current.
When the output current of the drive is not more than the motor rated current, the status is correct.
Ex.: 6 Hz → 20 Hz → 30 Hz → 40 Hz → 50 Hz → 60 Hz
8. Make sure that the motor rotates correctly, then push **STOP**.
The RUN indicator will flash. When the motor stops, the indicator will go out.

◆ Actual-Load Test Run

Test the operation without a load, then connect the motor and machine to do a test run.

■ Precautions before Operation

Before rotating the motor, check these items:

- Check for safety issues near the drive, motor, and machine.

4.9 Test Run









- Make sure that all emergency stop circuits and machine safety mechanisms are operating correctly.
- Make sure that the motor is fully stopped.
- Connect the motor with the machine.
Make sure that there are no loose installation screws and that the motor load shafts and machine junctions are correctly secured.
- Keep the keypad near you to push  immediately if there is unusual or incorrect operation.

■ Items to Check before Operation

- Make sure that the direction of the machine operation is correct (The motor must rotate in the correct direction).
- Make sure that the motor accelerates and decelerates smoothly.

◆ Do an Actual-Load Test Run

Connect the motor and machine, then do the test run with the same procedure you used for the no-load test run.

- Make sure that *U1-03 [Output Current]* is not too high.
 1. Energize the drive, or push  (Home) to show the HOME screen.
If [Home] is not shown on , push  (Back) to show [Home] on .
 2. Set *d1-01 [Reference 1]* to 6.00 Hz.
 3. Push  to illuminate the LOCAL/REMOTE indicator.
 4. Push .
The RUN indicator illuminates, and the motor runs at 6.00 Hz in the forward direction.
 5. Make sure that the motor is rotating in the correct direction and that the drive does not show a fault.
If the drive detects a fault, remove the cause.
 6. Push  to increase the frequency reference value.
Change the setting value in increments of 10 Hz if necessary and examine the response.
 7. Each time you increase the setting value, use *U1-03 [Output Current]* to check the drive output current.
When the output current of the drive is not more than the motor rated current, the status is correct.
Ex.: 6 Hz → 20 Hz → 30 Hz → 40 Hz → 50 Hz → 60 Hz
 8. Make sure that the motor rotates correctly, then push .
The RUN indicator will flash. When the motor stops, the indicator will go out.
 9. Change the frequency reference and direction of motor rotation, and make sure that there are no unusual sounds or vibrations.
 10. If there are hunting or oscillation errors caused by control function, adjust the settings to stop the errors.

4.10 Fine Tuning during Test Runs (Adjust the Control Function)

This section gives information about the adjustment procedures to stop hunting or oscillation errors caused by the control function during a test run. Adjust the applicable parameters as specified by your control method and drive status.

- [V/f Control and Closed Loop V/f Control on page 217](#)
- [Open Loop Vector Control Method on page 218](#)
- [Closed Loop Vector Control Method on page 220](#)
- [Advanced Open Loop Vector Control Method on page 220](#)
- [Open Loop Vector Control for PM Motors on page 221](#)
[Advanced Open Loop Vector Control Method for PM Motors on page 222](#)
[Closed Loop Vector Control Method for PM on page 223](#)
- [EZ Open Loop Vector Control Method on page 223](#)

Note:

This section only lists frequently adjusted parameters. If you must adjust parameters that have a higher degree of precision, contact Yaskawa.

◆ V/f Control and Closed Loop V/f Control

Table 4.17 Parameters for Fine Tuning the Drive (V/f and CL-V/f)

Issue	Parameter Number	Possible Solutions	Default	Recommended Setting
Hunting or oscillation in the middle speed range (10 Hz to 40 Hz)	n1-02 [Hunting Prevention Gain Setting]	<ul style="list-style-type: none"> • If torque is not sufficient with heavy loads, decrease the setting value. • If hunting or oscillation occur with light loads, increase the setting value. • If hunting occurs with a low-inductance motor, for example a motor with a larger frame size or a high-frequency motor, lower the setting value. 	1.00	0.10 - 2.00
Hunting or oscillation in the high speed range (120 Hz or more)	C4-25 [High-Speed Voltage Compensation]	Adjust the setting value.	1 [Enabled]	0 [Disabled]
<ul style="list-style-type: none"> • The volume of the motor excitation sound is too high. • Hunting or oscillation in the low speed range (10 Hz or lower), or in the middle speed range (10 Hz to 40 Hz) 	C6-02 [Carrier Frequency Selection]	<ul style="list-style-type: none"> • If the volume of the motor excitation sound is too high, increase the carrier frequency. • If hunting or oscillation occur in the low or middle speed range, decrease the carrier frequency. 	1 (2 kHz) *1	1 to upper limit value
<ul style="list-style-type: none"> • Unsatisfactory motor torque and speed response • Hunting or oscillation 	C4-02 [Torque Compensation Delay Time]	<ul style="list-style-type: none"> • If torque or speed response are slow, decrease the setting value. • If hunting or oscillation occur, increase the setting value. 	200 ms *2	100 ms to 1000 ms
<ul style="list-style-type: none"> • Torque in the low speed range (10 Hz or slower) is not sufficient. • Hunting or oscillation 	C4-01 [Torque Compensation Gain]	<ul style="list-style-type: none"> • If torque is not sufficient in the low speed range (10 Hz or slower), increase the setting value. • If hunting or oscillation occur with light loads, decrease the setting value. 	1.00	0.50 - 1.50
<ul style="list-style-type: none"> • Torque in the low speed range (10 Hz or slower) is not sufficient. • Large initial vibration at start up. 	<ul style="list-style-type: none"> • E1-08 [Mid Point A Voltage] • E1-10 [Minimum Output Voltage] 	<ul style="list-style-type: none"> • If torque is not sufficient in the low speed range (10 Hz or slower), increase the setting value. • If there is large initial vibration at start up, decrease the setting value. 	<ul style="list-style-type: none"> • E1-08: 15.0 V *3 • E1-10: 9.0 V *3 	Default setting +/- 5 V *4
In V/f control method, speed precision is unsatisfactory.	C3-01 [Slip Compensation Gain]	Set E2-01 [Motor Rated Current], E2-02 [Motor Rated Slip], and E2-03 [Motor No-Load Current], then adjust C3-01.	0.0 (no slip compensation)	0.5 - 1.5
In Closed Loop V/f control method, speed precision is unsatisfactory.	<ul style="list-style-type: none"> • C5-01 [ASR Proportional Gain 1] • C5-02 [ASR Integral Time 1] 	Adjust C5-01, C5-02.	<ul style="list-style-type: none"> • C5-01: 0.20 • C5-02: 0.200 s 	<ul style="list-style-type: none"> • Proportional gain = 0.10 to 1.00 • Integral time = 0.100 to 2.000 s

*1 The default setting changes when the settings for C6-01 [Normal / Heavy Duty Selection] and o2-04 [Drive Model (KVA) Selection] change.

4.10 Fine Tuning during Test Runs (Adjust the Control Function)

- *2 The default setting changes when the settings for *A1-02 [Control Method Selection]* and *o2-04 [Drive Model (KVA) Selection]* change.
- *3 The default setting changes when the settings for *A1-02 [Control Method Selection]* and *E1-03 [V/f Pattern Selection]* change.
- *4 Recommended settings are for 200 V class drives. Multiply the voltage by 2 for 400 V class drives.
- *5 In Closed Loop V/f Control, ASR only controls the output frequency. You cannot make a high-gain as in Closed Loop Vector control.

■ Precaution When You Use IE3 Premium Efficiency Motors

IE3 motors have different motor characteristics from IE1 and other motors. Set the parameters as specified by the motor characteristics. If you have a momentary power loss, and the drive detects *oC [Overcurrent]* or *ov [Overvoltage]* during speed search after it restores power, set these parameters:

- *b3-03 [Speed Search Deceleration Time]* = default value × 2
- *L2-03 [Minimum Baseblock Time]* = default value × 2
- *L2-04 [Powerloss V/f Recovery Ramp Time]* = default value × 2

◆ Open Loop Vector Control Method

In Open Loop Vector Control, keep *C4-01 [Torque Compensation Gain]* at its default setting (1.00).

If you cannot get speed precision during regeneration in Open Loop Vector Control, set *C3-04 = 1 [Slip Compensation at Regen = Enabled Above 6 Hz]*.

Table 4.18 Parameters for Fine Tuning the Drive (A1-02 = 2 [OLV])

Issue	Parameter Number	Possible Solutions	Default	Recommended Setting
<ul style="list-style-type: none"> • Unsatisfactory motor torque and speed response • Hunting or oscillation in the mid-range speed range (10 Hz to 40 Hz) 	n2-01 [Automatic Freq Regulator Gain]	<ul style="list-style-type: none"> • To increase the speed of torque or speed response, decrease the setting value in 0.05-unit increments. • If hunting or oscillation occur, decrease the setting value in 0.05-unit increments. 	1.00	0.50 - 2.00
	n2-02 [Automatic Freq Regulator Time 1]	<ul style="list-style-type: none"> • To increase the speed of torque or speed response, decrease the setting value in 10 ms increments and examine the response. • If hunting or oscillation occur or if the load inertia is too much, increase the setting value in 50 ms increments and examine the response. <p>Note: Make sure that this parameter setting is: $n2-02 \leq n2-03$ [<i>Automatic Freq Regulator Time 2</i>]. When you adjust <i>n2-02</i>, you must also increase the <i>C4-02 [Torque Compensation Delay Time]</i> value by the same ratio.</p>	50 ms	50 ms to 2000 ms
Hunting or oscillation in the high speed range (120 Hz or more)	C4-25 [High-Speed Voltage Compensation]	Adjust the setting value.	1 [Enabled]	0 [Disabled]

4.10 Fine Tuning during Test Runs (Adjust the Control Function)

Issue	Parameter Number	Possible Solutions	Default	Recommended Setting
<p><i>ov</i> [Overvoltage] occurs when the drive stops accelerating, starts to decelerate, or when there are large changes in the load.</p>	n2-03 [Automatic Freq Regulator Time 2]	<ul style="list-style-type: none"> If <i>ov</i> occurs, increase the setting value in 50 ms increments and examine the response. If the response is not sufficient, decrease the setting value in 10 ms increments and examine the response. <p>Note: Make sure that this parameter setting is: $n2-02$ [Automatic Freq Regulator Time 1] $\leq n2-03$. When you adjust $n2-03$, you must also increase the $C4-06$ [Motor 2 Torque Comp Delay Time] value by the same ratio.</p>	750 ms	750 ms to 2000 ms
	C4-06 [Motor 2 Torque Comp Delay Time]	<ul style="list-style-type: none"> If <i>ov</i> occurs, increase the setting value in 10 ms increments and examine the response. If the response is not sufficient, decrease the setting value in 2 ms increments and examine the response. <p>Note: Make sure that this parameter setting is: $C4-02$ [Torque Compensation Delay Time] $\leq C4-06$. When you adjust $C4-06$, you must also increase the $n2-03$ [Automatic Freq Regulator Time 2] value by the same ratio.</p>	150 ms	150 ms to 750 ms
<ul style="list-style-type: none"> Unsatisfactory motor torque and speed response Hunting or oscillation 	C4-02 [Torque Compensation Delay Time]	<ul style="list-style-type: none"> If torque or speed response are slow, decrease the setting value in 2 ms increments. If hunting or oscillation occur, increase the setting value in 10 ms increments. <p>Note: Make sure that this parameter setting is: $C4-02 \leq C4-06$ [Motor 2 Torque Comp Delay Time]. When you adjust $C4-02$, you must also increase the $n2-02$ [Automatic Freq Regulator Time 1] value by the same ratio.</p>	20 ms *1	20 ms - 100 ms *1
<ul style="list-style-type: none"> Speed response is slow. Speed is not stable. 	C3-02 [Slip Compensation Delay Time]	<ul style="list-style-type: none"> If speed response is slow, decrease the setting value in 10 ms increments. If speed is not stable, increase the value in 10 ms increments. 	200 ms *1	100 ms to 500 ms
Speed precision is unsatisfactory.	C3-01 [Slip Compensation Gain]	<ul style="list-style-type: none"> If speed is too slow, increase the setting value in 0.1 unit increments. If speed is too fast, decrease the setting value in 0.1 unit increments. 	1.0 *2	0.5 - 1.5
<ul style="list-style-type: none"> The volume of the motor excitation sound is too high. Hunting or oscillation in the low speed range (10 Hz or lower) 	C6-02 [Carrier Frequency Selection]	<ul style="list-style-type: none"> If the volume of the motor excitation sound is too high, increase the carrier frequency. If hunting or oscillation occur the the low speed range, decrease the carrier frequency. 	1 (2 kHz) *3	0 to upper limit value
<ul style="list-style-type: none"> Torque in the low speed range (10 Hz or lower) is not sufficient. Speed response is slow. Large initial vibration at start up. 	<ul style="list-style-type: none"> E1-08 [Mid Point A Voltage] E1-10 [Minimum Output Voltage] 	<ul style="list-style-type: none"> If torque or speed response are slow, increase the setting value. If there is large initial vibration at start up, decrease the setting value <p>Note: If you set the value too high, the drive can output a large torque reference although the load is light.</p>	<ul style="list-style-type: none"> E1-08: 11.0 V *2 E1-10: 2.0 V *2 	Default setting +/- 2 V *4

- *1 The default setting changes when the settings for $A1-02$ [Control Method Selection] and $o2-04$ [Drive Model (KVA) Selection] change.
- *2 The default setting changes when the settings for $A1-02$ [Control Method Selection] and $E1-03$ [V/f Pattern Selection] change.
- *3 The default setting changes when the settings for $C6-01$ [Normal / Heavy Duty Selection] and $o2-04$ change.
- *4 Recommended settings are for 200 V class drives. Multiply the voltage by 2 for 400 V class drives.

■ **Precaution When You Use IE3 Premium Efficiency Motors**

IE3 motors have different motor characteristics from IE1 and other motors. Set the parameters as specified by the motor characteristics. If you have a momentary power loss, and the drive detects *oC* [*Overcurrent*] or *ov* [*Overvoltage*] during speed search after it restores power, set these parameters:

- *b3-03* [*Speed Search Deceleration Time*] = default value × 2
- *L2-03* [*Minimum Baseblock Time*] = default value × 2
- *L2-04* [*Powerloss V/f Recovery Ramp Time*] = default value × 2

◆ **Closed Loop Vector Control Method**

Table 4.19 Parameters for Fine Tuning the Drive (CLV)

Issue	Parameter Number	Possible Solutions	Default	Recommended Setting
<ul style="list-style-type: none"> • Unsatisfactory motor torque and speed response • Hunting or oscillation 	<ul style="list-style-type: none"> • High speed C5-01 [ASR Proportional Gain 1] • Low speed C5-03 [ASR Proportional Gain 2 (P)] *1 	<ul style="list-style-type: none"> • If torque or speed response are slow, increase the setting value in increments of 5.00. • If hunting or oscillation occur, decrease the setting value. 	20.00	10.00 - 50.00
	<ul style="list-style-type: none"> • High speed C5-02 [ASR Integral Time 1] • Low speed C5-04 [ASR Integral Time 2] *1 	<ul style="list-style-type: none"> • If torque or speed response are slow, decrease the setting value. • If hunting or oscillation occur, increase the setting value. 	0.500 s	0.300 s to 1.000 s
Hunting or oscillation in the high speed range (120 Hz or more)	C4-25 [High-Speed Voltage Compensation]	Adjust the setting value.	1 [Enabled]	0 [Disabled]
The drive cannot find ASR proportional gain or integral time for low speed or high speed.	C5-07 [ASR Gain Switchover Frequency] *1	Change the ASR proportional gain and ASR integral time to conform to the output frequency.	0.0 Hz	0.0 Hz to maximum output frequency
Hunting or oscillation	C5-06 [ASR Delay Time] *1	<ul style="list-style-type: none"> • If torque or speed response are slow, decrease the setting value in increments of 0.010. • If the rigidity of the machine is unsatisfactory and vibration is possible, increase the setting value. 	0.004 s	0.004 s to 0.020 s
<ul style="list-style-type: none"> • The volume of the motor excitation sound is too high. • Hunting or oscillation in the low speed range (3 Hz or lower) 	C6-02 [Carrier Frequency Selection]	<ul style="list-style-type: none"> • If the volume of the motor excitation sound is too high, increase the carrier frequency. • If hunting or oscillation occur the low speed range, decrease the carrier frequency. 	1 (2.0 kHz) *2	2.0 kHz to upper limit value

*1 Refer to the section on *C5-xx parameters* for more information about speed control (ASR).

*2 The default setting changes when the settings for *C6-01* [*Normal / Heavy Duty Selection*] and *o2-04* [*Drive Model (KVA) Selection*] change.

◆ **Advanced Open Loop Vector Control Method**

Table 4.20 Parameters for Fine Tuning the Drive (AOLV)

Issue	Parameter Number	Possible Solutions	Default	Recommended Setting
<ul style="list-style-type: none"> • <i>oS</i> [<i>Overspeed</i>] occurs. • Hunting or oscillation. 	T1-01 [Auto-Tuning Mode Selection]	<ul style="list-style-type: none"> • Make sure that the output of the drive and the motor are connected correctly. • Do Rotational Auto-Tuning for a single motor. 	-	0
Hunting or oscillation in the high speed range (120 Hz or more)	C4-25 [High-Speed Voltage Compensation]	Adjust the setting value.	1 [Enabled]	0 [Disabled]
The volume of the motor excitation sound is too high.	C6-02 [Carrier Frequency Selection]	If the volume of the motor excitation sound is too high, increase the carrier frequency.	1 (2 kHz) *1	1 to upper limit value
Speed precision is unsatisfactory	E2-02 [Motor Rated Slip]	<ul style="list-style-type: none"> • Decouple the motor and machine and do Rotational Auto-Tuning. • If the motor speed is slow, increase the value of <i>E2-02</i> in small increments (approximately 0.1% of the default setting value). • If the motor speed is fast, decrease the value of <i>E2-02</i> in small increments (approximately 0.1% of the default setting value). 	*2	Set to a value that is ±5% of the current value.

4.10 Fine Tuning during Test Runs (Adjust the Control Function)

Issue	Parameter Number	Possible Solutions	Default	Recommended Setting
<ul style="list-style-type: none"> Unsatisfactory motor torque and speed response Hunting or oscillation 	<ul style="list-style-type: none"> High speed C5-01 [ASR Proportional Gain 1] Low speed C5-03 [ASR Proportional Gain 2 (P)] *3 	<ul style="list-style-type: none"> If torque or speed response are slow, increase the setting value in increments of 5.00. If hunting or oscillation occur, decrease the setting value. 	<ul style="list-style-type: none"> C5-01 = 10.00 C5-03 = 20.00 	10.00 - 50.00
	<ul style="list-style-type: none"> High speed C5-02 [ASR Integral Time 1] Low speed C5-04 [ASR Proportional Gain 2 (P)] *3 	<ul style="list-style-type: none"> If torque or speed response are slow, decrease the setting value. If hunting or oscillation occur, increase the setting value. 	0.500 s	0.300 s to 1.000 s
The drive cannot find speed response for low speed or high speed.	<ul style="list-style-type: none"> C5-07 [ASR Gain Switchover Frequency] *4 High speed C5-01 [ASR Proportional Gain 1] C5-02 [ASR Integral Time 1] Low speed C5-03 [ASR Proportional Gain 2 (P)] *3 C5-04 [ASR Integral Time 2] 	Change the ASR proportional gain and ASR integral time to conform to the output frequency.	<ul style="list-style-type: none"> C5-07 = 0.0 Hz C5-01 = 10.00 C5-02 = 0.500 s C5-03 = 20.00 C5-04 = 0.500 s 	C5-07: 0.0 to maximum output frequency
Hunting or oscillation	C5-06 [ASR Delay Time] *4	<ul style="list-style-type: none"> If torque or speed response are slow, decrease the setting value in increments of 0.010. If the rigidity of the machine is unsatisfactory and vibration is possible, increase the setting value. 	0.004 s	0.004 s to 0.020 s
When you operate the drive at a frequency close to zero speed, the motor rotates at a frequency slightly higher than the frequency reference.	<ul style="list-style-type: none"> E1-09 [Minimum Output Frequency] n4-70 [Speed Command Comp @ Low Freq] 	<ul style="list-style-type: none"> Set E1-09 > 0. Note: When frequency reference E1-09 < 0, the drive output will turn OFF. Decrease the setting value of n4-70 in 0.1 Hz increments. Note: If you set the value too low, the motor can rotate in reverse. 	<ul style="list-style-type: none"> E1-09 = 0.0 Hz n4-70 = 1.00 Hz 	<ul style="list-style-type: none"> E1-09 = 0.5 Hz n4-70 = 0.50 Hz

*1 The default setting changes when the settings for C6-01 [Normal / Heavy Duty Selection] and o2-04 [Drive Model (KVA) Selection] change.

*2 The default setting changes when the setting for o2-04 [Drive Model Selection] changes.

*3 Refer to the section on C5-xx parameters for more information about speed control (ASR).

*4 The best values for a no-load operation are different than the best values for actual loading operation.

◆ Open Loop Vector Control for PM Motors

Table 4.21 Parameters for Fine Tuning the Drive (A1-02 = 5 [OLV/PM])

Issue	Parameter Number	Possible Solutions	Default	Recommended Setting
Unsatisfactory motor performance	E1-xx parameters, E5-xx parameters	<ul style="list-style-type: none"> Check the settings for E1-06, E1-04 [Base Frequency, Maximum Output Frequency]. Check the E5-xx and make sure that you set all motor data correctly. Note: Do not set E5-05 [PM Motor Resistance (ohms/phase)] to a line-to-line resistance value. Do Auto-Tuning. 	-	-
Unsatisfactory motor torque and speed response	n8-55 [Motor to Load Inertia Ratio]	Adjust to align the load inertia ratio of the motor and machine.	0	Near the load inertia ratio.
	n8-45 [Speed Feedback Detection Gain]	Decrease the setting value in increments of 0.05.	0.80	-
	C4-01 [Torque Compensation Gain]	Adjust the setting value. Note: If you set this value too high, it can cause overcompensation and motor oscillation.	0.00	1.00

4.10 Fine Tuning during Test Runs (Adjust the Control Function)

Issue	Parameter Number	Possible Solutions	Default	Recommended Setting
<ul style="list-style-type: none"> Oscillation when the motor starts. Motor stalls. 	n8-51 [Pull-in Current @ Accel/Decel]	Increase the setting value in increments of 5%.	50%	-
	<ul style="list-style-type: none"> b2-02 [DC Injection Braking Current] b2-03 [DC Inject Braking Time at Start] 	Use DC Injection Braking at start. Note: This can cause the motor to rotate in reverse for approximately 1/8 of a turn at start.	<ul style="list-style-type: none"> b2-02: 50% b2-03: 0.00 s 	<ul style="list-style-type: none"> b2-02: Adjust as necessary. b2-03: 0.5 s
	n8-55 [Motor to Load Inertia Ratio]	Increase the setting value. Note: When you operate a single motor or with a minimum quantity of inertia, if you set this value too high, it can cause motor oscillation.	0	Near the load inertia ratio.
There is too much current during deceleration.	n8-79 [Pull-in Current at Deceleration]	Set $n8-79 < n8-51$.	50% Note: When $n8-79 = 0$, the drive will apply the $n8-51$ setting to the pull-in current during deceleration.	Decrease in increments of 5%.
Stalling or oscillation occurs when you apply the load during constant speed	n8-47 [Pull-in Current Comp Filter Time]	Decrease the setting value in increments of 0.2 s.	5.0 s	-
	n8-48 [Pull-in/Light Load Id Current]	Increase the setting value in increments of 5%.	30%	-
	n8-55 [Motor to Load Inertia Ratio]	Increase the setting value. Note: When you operate a single motor or with a minimum quantity of inertia, if you set this value too high, it can cause motor oscillation.	0	Near the load inertia ratio.
Hunting or oscillation	n8-45 [Speed Feedback Detection Gain]	Increase the setting value in increments of 0.05.	0.80	-
The drive detects <i>STPo</i> [Motor Step-Out Detected] fault when the load is not too high.	<ul style="list-style-type: none"> E5-09 [PM Back-EMF Vpeak (mV/(rad/s))] E5-24 [PM Back-EMF L-L Vrms (mV/rpm)] 	<ul style="list-style-type: none"> Adjust the setting value. Examine the motor code on the motor nameplate or the data sheet, then set correct values for <i>E5-09</i> or <i>E5-24</i>. 	*1	<ul style="list-style-type: none"> Yaskawa motor Set the motor code from the motor nameplate. Motor from another manufacturer Set the values from the test report.
The drive detected stalling or <i>STPo</i> [Motor Step-Out Detected] at high speed and maximum output voltage.	n8-62 [Output Voltage Limit Level]	Set to a value lower than the actual input voltage.	<ul style="list-style-type: none"> 200.0 V 400.0 V 	-

*1 The default setting changes when the settings for *E5-01* [Motor Code Selection] and *o2-04* [Drive Model (KVA) Selection] change.

◆ Advanced Open Loop Vector Control Method for PM Motors

Table 4.22 Parameters for Fine Tuning the Drive (A1-02 = 6 [AOLV/PM])

Issue	Parameter Number	Possible Solutions	Default	Recommended Setting
<ul style="list-style-type: none"> Unsatisfactory motor torque and speed response Hunting or oscillation 	<ul style="list-style-type: none"> High speed C5-01 [ASR Proportional Gain 1] Low speed C5-03 [ASR Proportional Gain 2] 	<ul style="list-style-type: none"> If torque or speed response are slow, increase the setting value in increments of 5.00. If hunting or oscillation occur, decrease the setting value. 	10.00	5.00 to 30.00 *1
	<ul style="list-style-type: none"> High speed C5-02 [ASR Integral Time 1] Low speed C5-04 [ASR Integral Time 2] 	<ul style="list-style-type: none"> If torque or speed response are slow, decrease the setting value. If hunting or oscillation occur, increase the setting value. 	0.500 s	0.300 s to 1.000 s *1
	C5-07 [ASR Gain Switchover Frequency]	Change the ASR proportional gain and ASR integral time to conform to the output frequency.	0.0%	0.0% to maximum rotation speed
Hunting or oscillation	C5-06 [ASR Delay Time]	If the rigidity of the machine is unsatisfactory and vibration is possible, increase the setting value in increments of 0.010.	0.016 s	0.016 s to 0.035 s *1
Step-out	E1-xx parameters, E5-xx parameters	Refer to the motor nameplate or test report and set <i>E1-xx</i> or <i>E5-xx</i> correctly.	-	-

*1 The best values for a no-load operation are different than the best values for actual loading operation.

◆ Closed Loop Vector Control Method for PM

Table 4.23 Parameters for Fine Tuning the Drive (CLV/PM)

Issue	Parameter Number	Possible Solutions	Default	Recommended Setting
<ul style="list-style-type: none"> Unsatisfactory motor torque and speed response Hunting or oscillation 	<ul style="list-style-type: none"> High speed C5-01 [ASR Proportional Gain 1] Low speed C5-03 [ASR Proportional Gain 2] 	<ul style="list-style-type: none"> If torque or speed response are slow, increase the setting value in increments of 5.00. If hunting or oscillation occur, decrease the setting value. 	20.00	10.00 to 50.00 ^{*1}
	<ul style="list-style-type: none"> High speed C5-02 [ASR Integral Time 1] Low speed C5-04 [ASR Integral Time 2] 	<ul style="list-style-type: none"> If torque or speed response are slow, decrease the setting value. If hunting or oscillation occur, increase the setting value. 	0.500 s	0.300 to 1.000 s ^{*1}
The drive cannot find speed response for low speed or high speed.	<ul style="list-style-type: none"> C5-07 [ASR Gain Switchover Frequency] High speed C5-01 [ASR Proportional Gain 1] C5-02 [ASR Integral Time 1] Low speed C5-03 [ASR Proportional Gain 2] C5-04 [ASR Integral Time 2] 	Change the ASR proportional gain and ASR integral time to conform to the output frequency.	<ul style="list-style-type: none"> C5-07 = 0.0 % C5-01 = 20.00 C5-02 = 0.500 s C5-03 = 20.00 C5-04 = 0.500 s 	0.0% to maximum rotation speed
Hunting or oscillation	C5-06 [ASR Delay Time]	If the rigidity of the machine is unsatisfactory and vibration is possible, increase the setting value in increments of 0.010.	0.004 s	0.004 to 0.020 s ^{*1}
Step-out	E1-xx parameters, E5-xx parameters	Refer to the motor nameplate or test report and set E1-xx or E5-xx correctly.	-	-

*1 The best values for a no-load operation are different than the best values for actual loading operation.

◆ EZ Open Loop Vector Control Method

Table 4.24 Parameters for Fine Tuning the Drive (A1-02 = 8 [EZOLV])

Issue	Parameter Number	Possible Solutions	Default	Recommended Setting
<ul style="list-style-type: none"> Unsatisfactory motor torque and speed response Hunting or oscillation 	<ul style="list-style-type: none"> High speed C5-01 [ASR Proportional Gain 1] Low speed C5-03 [ASR Proportional Gain 2] 	<ul style="list-style-type: none"> If torque or speed response are slow, increase the setting value in increments of 5.00. If hunting or oscillation occur, decrease the setting value. 	10.00	10.00 to 50.00 ^{*1}
	<ul style="list-style-type: none"> High speed C5-02 [ASR Integral Time 1] Low speed C5-04 [ASR Integral Time 2] 	<ul style="list-style-type: none"> If torque or speed response are slow, decrease the setting value. If hunting or oscillation occur, increase the setting value. 	0.500 s	0.300 s to 1.000 s ^{*1}
The drive cannot find ASR proportional gain or integral time for low speed or high speed.	C5-07 [ASR Gain Switchover Frequency]	Change the ASR proportional gain and ASR integral time to conform to the output frequency.	0.0%	0.0% to maximum rotation speed
Hunting or oscillation	C5-06 [ASR Delay Time]	If the rigidity of the machine is unsatisfactory and vibration is possible, increase the setting value in increments of 0.010.	0.004 s	0.004 s to 0.020 s ^{*1}
Step-out	E9-xx parameters	Refer to the motor nameplate or test report and set E9-xx correctly.	-	-
Oscillation when the motor starts.	n8-51 [Accel / Decel Pull-In Current]	Increase the setting value.	80%	Increase in increments of 5%.
Motor stalls.	L7-01 to L7-04 [Torque Limit]	Increase the setting value.	200%	Increase in increments of 10%.

*1 The best values for a no-load operation are different than the best values for actual loading operation.

4.11 Test Run Checklist

Examine the items in this checklist and check each item before a test run.

Checked	No.	Description
	1	Correctly install and wire the drive as specified by this manual.
	2	Energize the drive.
	3	Set the voltage for the power supply in E1-01 [Input AC Supply Voltage].

Check the applicable items as specified by your control method.

WARNING! Sudden Movement Hazard. Correctly wire the start/stop and safety circuits before you energize the drive. If you momentarily close a digital input terminal, it can start a drive that is programmed for 3-Wire control and cause serious injury or death from moving equipment.

Table 4.25 V/f Control [A1-02 = 0] and Closed Loop V/f Control [A1-02 = 1]

Checked	No.	Description
	4	Select the best V/f pattern for your application and motor characteristics. Example: For a motor with a rated frequency of 60 Hz, set E1-03 = 1 [V/f Pattern Selection = Const Trq, 60Hz base, 60Hz max] as a standard V/f pattern.

Table 4.26 Closed Loop V/f Control [A1-02 = 1]

Checked	No.	Description
	5	Set F1-01 [Encoder 1 Pulse Count (PPR)] correctly and make sure that encoder pulse counting direction is correct.
	6	Set C5-01 [ASR Proportional Gain 1] and C5-02 [ASR Integral Time 1].

Table 4.27 Open Loop Vector Control [A1-02 = 2] or Closed Loop Vector Control [A1-02 = 3]

Checked	No.	Description
	7	Decouple motor shafts and machines.
	8	Refer to the information on the motor nameplate and set this data correctly: <ul style="list-style-type: none"> • Motor rated power (kW) to T1-02 • Motor rated voltage (V) to T1-03 • Motor rated current (A) to T1-04 • Motor base frequency (Hz) to T1-05 • Number of motor poles to T1-06 • Motor base speed (min⁻¹) to T1-07
	9	Do Rotational Auto-Tuning.

Table 4.28 Closed Loop Vector Control [A1-02 = 3]

Checked	No.	Description
	10	Set F1-01 [Encoder 1 Pulse Count (PPR)] and F1-05 [Encoder 1 Rotation Selection].
	11	Set C5-01 [ASR Proportional Gain 1] and C5-02 [ASR Integral Time 1].

Table 4.29 PM Open Loop Vector Control [A1-02 = 5]

Checked	No.	Description
	12	Set E5-01 through E5-24 [PM Motor Settings].

Table 4.30 PM Advanced Open Loop Vector [A1-02 = 6]

Checked	No.	Description
	13	Set E5-01 through E5-24 [PM Motor Settings].
	14	Set C5-01 [ASR Proportional Gain 1] and C5-02 [ASR Integral Time 1].

Table 4.31 PM Closed Loop Vector Control [A1-02 = 7]

Checked	No.	Description
	15	Set E5-01 through E5-24 [PM Motor Settings].
	16	Set C5-01 [ASR Proportional Gain 1] and C5-02 [ASR Integral Time 1].
	17	Set F1-01 [Encoder 1 Pulse Count (PPR)] and F1-05 [Encoder 1 Rotation Selection].
	18	Set E5-11 [Encoder Z-Pulse Offset].

Checked	No.	Description
	19	The keypad will show "Rdy" after starting to operate the motor.
	20	To give the Run command and frequency reference from the keypad, push LO/RE to set to LOCAL Mode (when in LOCAL Mode, the LO/RE LED illuminates).
	21	If the motor rotates in the opposite direction during test run, switch two of the motor cables (U/T1, V/T2, W/T3).
	22	Set Heavy Duty or Normal Duty Mode with C6-01 [Normal / Heavy Duty Selection] to conform to the load condition.
	23	Set E2-01 [Motor Rated Current (FLA)] and L1-01 [Motor Overload Protection Select] correctly for motor thermal protection.
	24	Set the drive for REMOTE Mode when the control circuit terminals supply the Run command and frequency reference (in REMOTE Mode, the LO/RE LED turns OFF).
	25	<p>When terminal A1 is used for the frequency reference:</p> <ul style="list-style-type: none"> • Voltage input <ul style="list-style-type: none"> – Set DIP Switch S1-1 on the drive to "V". – Set H3-01 = 0, 1 [Terminal A1 Signal Level Select = 0 to 10V (Lower Limit at 0), -10 to +10V (Bipolar Reference)]. – Set H3-02 = 0 [Terminal A1 Function Selection = Frequency Reference]. • Current input <ul style="list-style-type: none"> – Set DIP Switch S1-1 on the drive to "I". – Set H3-01 = 2, 3 [Terminal A1 Signal Level Select = 4 to 20 mA, 0 to 20 mA]. – Set H3-02 = 0 [Terminal A1 Function Selection = Frequency Reference].
	26	<p>When terminal A2 is used for the frequency reference:</p> <ul style="list-style-type: none"> • Voltage input <ul style="list-style-type: none"> – Set DIP Switch S1-2 on the drive to "V". – Set H3-09 = 0, 1 [Terminal A2 Signal Level Select = 0 to 10V (Lower Limit at 0), -10 to 10V (Bipolar Reference)]. – Set H3-10 = 0 [Terminal A2 Function Selection = Frequency Reference]. • Current input <ul style="list-style-type: none"> – Set DIP Switch S1-2 on the drive to "I". – Set H3-09 = 2, 3 [Terminal A2 Signal Level Select = 4 to 20 mA, 0 to 20 mA]. – Set H3-10 = 0 [Terminal A2 Function Selection = Frequency Reference].
	27	<p>When terminal A3 is used for the frequency reference:</p> <ul style="list-style-type: none"> • Voltage input <ul style="list-style-type: none"> – Set DIP Switch S4 on the drive to analog input side. – Set DIP Switch S1-3 on the drive to "V". – Set H3-05 = 0, 1 [Terminal A3 Signal Level Select = 0 to 10V (Lower Limit at 0), -10 to +10V (Bipolar Reference)]. – Set H3-06 = 0 [Terminal A3 Function Selection = Frequency Reference]. • Current input <ul style="list-style-type: none"> – Set DIP Switch S4 on the drive to analog input side. – Set DIP Switch S1-3 on the drive to "I". – Set H3-05 = 2, 3 [Terminal A3 Signal Level Select = 4 to 20 mA (Lower Limit at 4), 0 to 20 mA (Bipolar Reference)]. – Set H3-06 = 0 [Terminal A3 Function Selection = Frequency Reference].
	28	<p>Make sure that the frequency reference reaches the necessary minimum and maximum values.</p> <p>→ If drive operation is incorrect, make these adjustments:</p> <p>Gain adjustment: Set the maximum voltage and current values, then adjust the analog input gain until the frequency reference reaches the necessary value. (For terminal A1 input: H3-03, for terminal A2 input: H3-11, for terminal A3 input: H3-07)</p> <p>Bias adjustment: Set the maximum voltage/current values, then adjust the analog input bias until the frequency reference reaches the necessary minimum value. (For terminal A1 input: H3-04, for terminal A2 input: H3-12, for terminal A3 input: H3-08)</p>

Standards Compliance

This chapter gives information about how to make the machines and devices that use this product comply with European standards and UL standards.

5.1	Section Safety	228
5.2	European Standards.....	230
5.3	United Kingdom Conformity Assessed Marking.....	259
5.4	UL Standards	260
5.5	China RoHS Compliance	288
5.6	对应中国RoHS指令	289
5.7	Safe Disable Input	290

5.1 Section Safety

DANGER

Electrical Shock Hazard

Do not examine, connect, or disconnect wiring on an energized drive. Before servicing, disconnect all power to the equipment and wait for the time specified on the warning label at a minimum. The internal capacitor stays charged after the drive is de-energized. The charge indicator LED extinguishes when the DC bus voltage decreases below 50 Vdc. When all indicators are OFF, remove the covers before measuring for dangerous voltages to make sure that the drive is safe.

If you do work on the drive when it is energized, it will cause serious injury or death from electrical shock.

WARNING

Electrical Shock Hazard

Do not operate the drive when covers are missing. Replace covers and shields before you operate the drive. Use the drive only as specified by the instructions.

Some figures in this section include drives without covers or safety shields to more clearly show the inside of the drive. If covers or safety shields are missing from the drive, it can cause serious injury or death.

Always ground the motor-side grounding terminal.

If you do not ground the equipment correctly, it can cause serious injury or death if you touch the motor case.

Do not remove covers or touch circuit boards while the drive is energized.

If you touch the internal components of an energized drive, it can cause serious injury or death.

Only let approved personnel install, wire, maintain, examine, replace parts, and repair the drive.

If personnel are not approved, it can cause serious injury or death.

Do not wear loose clothing or jewelry when you do work on the drive. Tighten loose clothing and remove all metal objects, for example watches or rings.

Loose clothing can catch on the drive and jewelry can conduct electricity and cause serious injury or death.

Do not modify the drive body or drive circuitry.

Modifications to drive body and circuitry can cause serious injury or death, will cause damage to the drive, and will void the warranty. Yaskawa is not responsible for modifications of the product made by the user.

Fire Hazard

Tighten all terminal screws to the correct tightening torque.

Connections that are too loose or too tight can cause incorrect operation and damage to the drive. Incorrect connections can also cause death or serious injury from fire.

Tighten screws at an angle in the specified range shown in this manual.

If you tighten the screws at an angle not in the specified range, you can have loose connections that can cause damage to the terminal block or start a fire and cause serious injury or death.

Damage to Equipment

Do not apply incorrect voltage to the main circuit of the drive. Operate the drive in the specified range of the input voltage on the drive nameplate.

Voltages that are higher than the permitted nameplate tolerance can cause damage to the drive.

Fire Hazard

Do not put flammable or combustible materials on top of the drive and do not install the drive near flammable or combustible materials. Attach the drive to metal or other noncombustible material.

Flammable and combustible materials can start a fire and cause serious injury or death.

⚠ WARNING**Crush Hazard**

Wear eye protection when you do work on the drive.

If you do not use correct safety equipment, it can cause serious injury or death.

Electrical Shock Hazard

After the drive blows a fuse or trips an RCM/RCD, do not immediately energize the drive or operate peripheral devices. Wait for the time specified on the warning label at a minimum and make sure that all indicators are OFF. Then check the wiring and peripheral device ratings to find the cause of the problem. If you do not know the cause of the problem, contact Yaskawa before you energize the drive or peripheral devices.

If you do not fix the problem before you operate the drive or peripheral devices, it can cause serious injury or death.

NOTICE**Damage to Equipment**

When you touch the drive and circuit boards, make sure that you observe correct electrostatic discharge (ESD) procedures.

If you do not follow procedures, it can cause ESD damage to the drive circuitry.

Do not break the electrical connection between the drive and the motor when the drive is outputting voltage.

Incorrect equipment sequencing can cause damage to the drive.

Before you connect a dynamic braking option to the drive, make sure that qualified personnel read and obey the Braking Unit and Braking Resistor Unit Installation Manual (TOBPC72060001).

If you do not read and obey the manual or if personnel are not qualified, it can cause damage to the drive and braking circuit.

Make sure that all connections are correct after you install the drive and connect peripheral devices.

Incorrect connections can cause damage to the drive.

Note:

Do not use unshielded cable for control wiring. Use shielded, twisted-pair wires and ground the shield to the ground terminal of the drive. Unshielded wire can cause electrical interference and unsatisfactory system performance.

5.2 European Standards



Figure 5.1 CE Mark

The CE Mark identifies that the product meets environmental and safety standards in the European Union. Products manufactured, sold, or imported in the European Union must display the CE Mark.

European Union standards include standards for electrical appliances (Low Voltage Directive), standards for electrical noise (EMC Directive), and standards for machinery (Machinery Directive).

This product displays the CE Mark in accordance with the Low Voltage Directive, the EMC Directive, and the Machinery Directive.

Table 5.1 Harmonized Standards

European Directive	Harmonized Standards
CE Low Voltage Directive Compliance 2014/35/EU	EN 61800-5-1 ^{*1}
Electromagnetic Compatibility Regulations 2014/30/EU	EN 61800-3 ^{*1}
Machinery Directive 2006/42/EC	<ul style="list-style-type: none"> • EN ISO 13849-1:2015 (PL e (Cat.III)) • EN 62061 (SILCL3) ^{*1} • IEC/EN 61800-5-2 (SIL3) ^{*1}
Restriction of the use of certain hazardous substances (RoHS) 2011/65/EU	EN IEC 63000 ^{*1}

*1 Refer to "EU Declaration of Conformity" for the year of the Designated Standards.

The customer must display the CE Mark on the final device containing this product. Customers must verify that the final device complies with EU standards.

Table 5.2 Other Applicable Standards

European Directive	Applicable Standards
EU ErP Directive 2009/125/EC	<p>The drive meets the requirements for IE2 efficiency according to the European regulation 2019/1781.</p> <p>The losses and the efficiency were measured in accordance with the requirements of IEC 61800-9-2.</p>

◆ CE Low Voltage Directive Compliance

It has been confirmed that this product complies with the CE Low Voltage Directive by conducting a test according to IEC/EN 61800-5-1.

The following conditions must be satisfied for machines and devices incorporating this product to comply with the CE Low Voltage Directive.

■ Area of Use

Install this product in a location with Overvoltage Category III and pollution degree 2 or less as specified in IEC/CE 60664.

■ Guarding Against Debris

When you install IP20/UL Open type drives (models: 2xxxxB, 4xxxxB) and IP00/UL Open type drives (models: 4xxxxA), use an enclosure panel that does not let unwanted material enter the drive from above or below.

■ Electrical Installation

Refer to [Figure 5.2](#) and [Figure 5.3](#) for examples of drives that are wired to comply with the CE Low Voltage Directive.

Three-Phase Drive

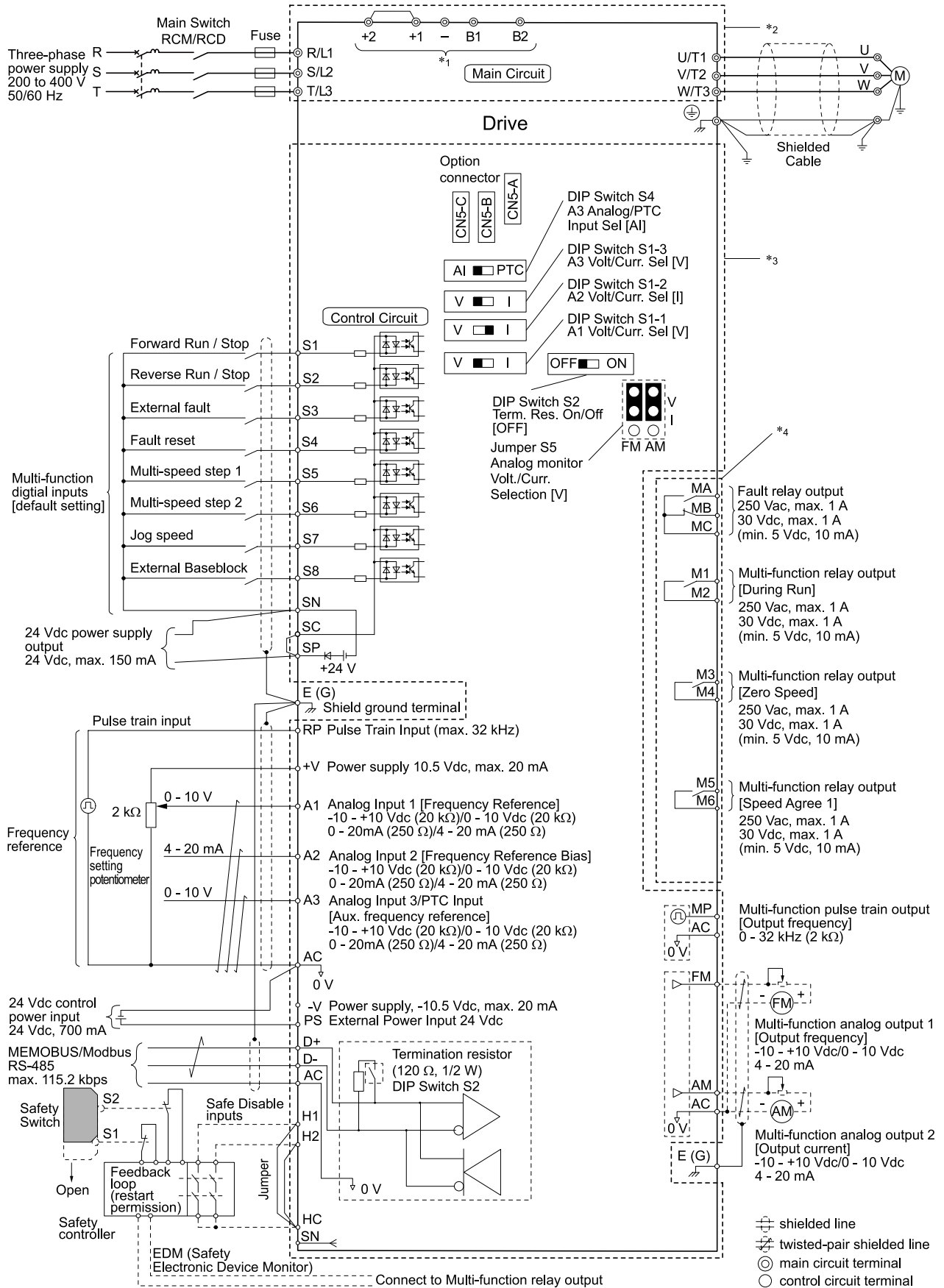

Figure 5.2 Wiring Diagram for CE Low Voltage Directive Compliance

*1 Connect peripheral options to terminals -, +1, +2, B1, and B2.

WARNING! Sudden Movement Hazard. Make sure that the polarity is correct before you send a Run command. If the drive incorrectly detects the polarity, the drive can rotate in the direction opposite of the Run command and cause serious injury or death.

5.2 European Standards

- *2 To protect the circuit, the main circuit is separate from the surface case that can touch the main circuit.
- *3 The control circuit is a Safety Extra-Low Voltage circuit. Use reinforced insulation to separate this circuit from other circuits. Make sure that you connect the Safety Extra-Low Voltage as specified.
- *4 Reinforced insulation separates the output terminals from other circuits. You can also connect circuits that are not Safety Extra-Low Voltage circuits when the drive output is 250 Vac, 1 A maximum or 30 VDC, 1 A maximum.

6-Phase/12-Pulse Drives

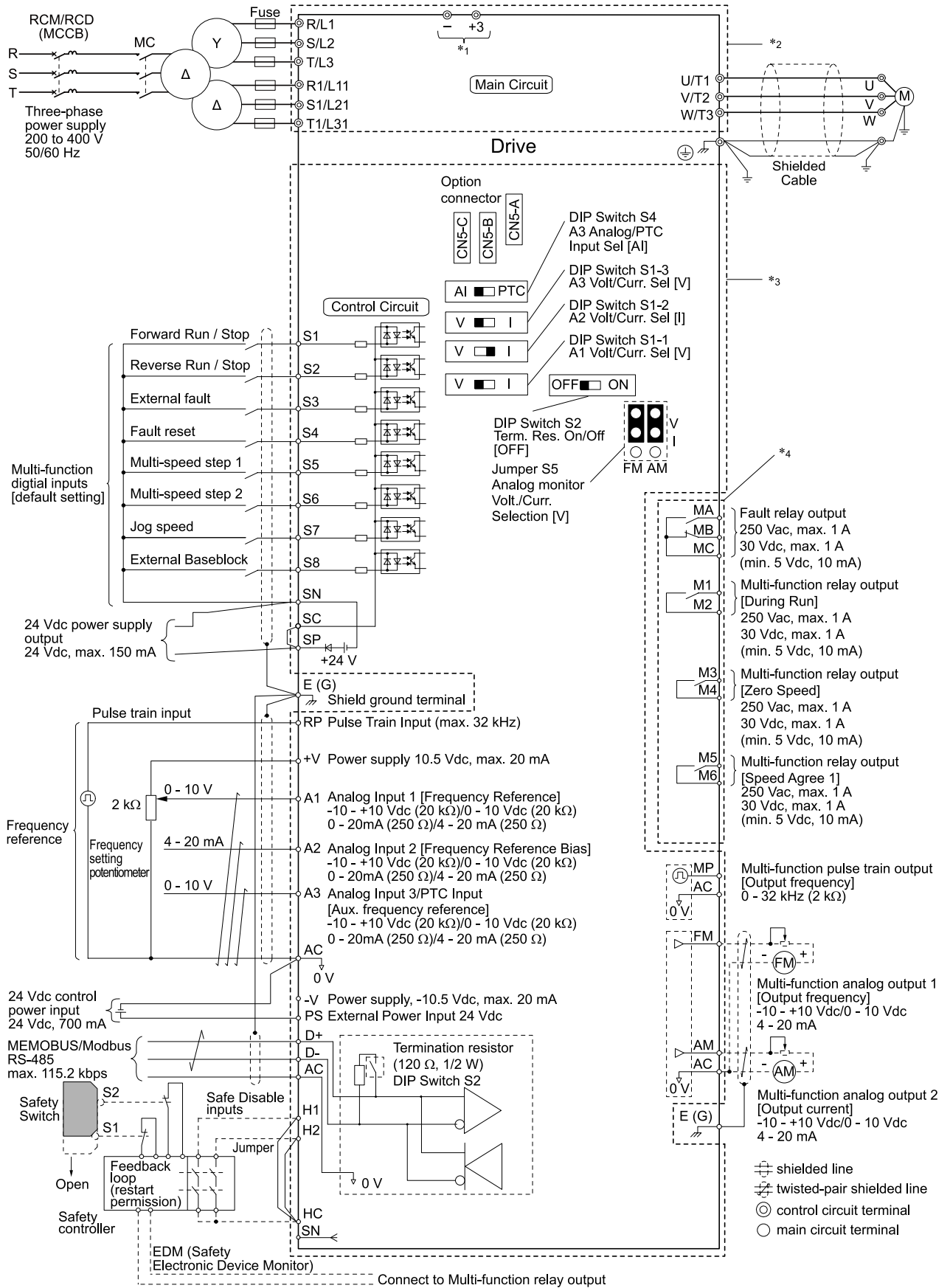

Figure 5.3 Wiring Diagram for CE Low Voltage Directive Compliance: 6-Phase/12-Pulse Drives

*1 Use terminals - and +3 to connect options to the drive.

WARNING! Sudden Movement Hazard. Make sure that the polarity is correct before you send a Run command. If the drive incorrectly detects the polarity, the drive can rotate in the direction opposite of the Run command and cause serious injury or death.

5.2 European Standards

- *2 To protect the circuit, the main circuit is separate from the surface case that can touch the main circuit.
- *3 The control circuit is a Safety Extra-Low Voltage circuit. Use reinforced insulation to separate this circuit from other circuits. Make sure that you connect the Safety Extra-Low Voltage as specified.
- *4 Reinforced insulation separates the output terminals from other circuits. You can also connect circuits that are not Safety Extra-Low Voltage circuits when the drive output is 250 Vac, 1 A maximum or 30 VDC, 1 A maximum.

■ Main Circuit Wire Gauges and Tightening Torques

WARNING! Electrical Shock Hazard. Only connect peripheral options, for example a DC reactor or braking resistor, to terminals +1, +2, +3, -, B1, and B2. Incorrect wiring can cause serious injury or death.

Note:

- The recommended wire gauges are based on drive continuous current ratings with 75 °C (167 °F) 600 V class 2 heat-resistant indoor PVC wire. Assume these conditions:
 - Ambient temperature: 40 °C (104 °F) maximum
 - Wiring distance: 100 m (328 ft) maximum
 - Normal Duty rated current value
- Refer to the instruction manual for each device for recommended wire gauges to connect peripheral devices or options to terminals +1, +2, +3, -, B1, and B2. Contact Yaskawa or your nearest sales representative if the recommended wire gauges for the peripheral devices or options are out of the range of the applicable gauges for the drive.

Three-Phase 200 V Class

Model	Terminal	Recomm. Gauge mm ²	Applicable Gauge (IP20 Applicable Gauge *) mm ²	Wire Stripping Length *2 mm	Terminal Screw Size and Shape	Tightening Torque N·m (lbf·in)
2004	R/L1, S/L2, T/L3	2.5	2.5 - 10 (2.5 - 10)	10	M4 ⊖	1.5 - 1.7 (13.5 - 15)
	U/T1, V/T2, W/T3	2.5	2.5 - 10 (2.5 - 10)	10	M4 ⊖	1.5 - 1.7 (13.5 - 15)
	-, +1, +2	2.5	2.5 - 16 (2.5 - 16)	18	M5 ⊖	2.3 - 2.5 (19.8 - 22)
	B1, B2	2.5	2.5 - 4 (2.5 - 4)	10	M4 ⊖	1.5 - 1.7 (13.5 - 15)
	⊕	2.5	2.5 - 10 (-)	-	M4 ⊕	1.2 - 1.5 (10.6 - 13.3)
2006	R/L1, S/L2, T/L3	2.5	2.5 - 10 (2.5 - 10)	10	M4 ⊖	1.5 - 1.7 (13.5 - 15)
	U/T1, V/T2, W/T3	2.5	2.5 - 10 (2.5 - 10)	10	M4 ⊖	1.5 - 1.7 (13.5 - 15)
	-, +1, +2	2.5	2.5 - 16 (2.5 - 16)	18	M5 ⊖	2.3 - 2.5 (19.8 - 22)
	B1, B2	2.5	2.5 - 4 (2.5 - 4)	10	M4 ⊖	1.5 - 1.7 (13.5 - 15)
	⊕	2.5	2.5 - 10 (-)	-	M4 ⊕	1.2 - 1.5 (10.6 - 13.3)
2010	R/L1, S/L2, T/L3	2.5	2.5 - 10 (2.5 - 10)	10	M4 ⊖	1.5 - 1.7 (13.5 - 15)
	U/T1, V/T2, W/T3	2.5	2.5 - 10 (2.5 - 10)	10	M4 ⊖	1.5 - 1.7 (13.5 - 15)
	-, +1, +2	2.5	2.5 - 16 (2.5 - 16)	18	M5 ⊖	2.3 - 2.5 (19.8 - 22)
	B1, B2	2.5	2.5 - 4 (2.5 - 4)	10	M4 ⊖	1.5 - 1.7 (13.5 - 15)
	⊕	2.5	2.5 - 10 (-)	-	M4 ⊕	1.2 - 1.5 (10.6 - 13.3)

Model	Terminal	Recomm. Gauge mm ²	Applicable Gauge (IP20 Applicable Gauge *) mm ²	Wire Stripping Length *2 mm	Terminal Screw Size and Shape	Tightening Torque N·m (lbf·in)
2012	R/L1, S/L2, T/L3	2.5	2.5 - 10 (2.5 - 10)	10	M4 ⊖	1.5 - 1.7 (13.5 - 15)
	U/T1, V/T2, W/T3	2.5	2.5 - 10 (2.5 - 10)	10	M4 ⊖	1.5 - 1.7 (13.5 - 15)
	-, +1, +2	2.5	2.5 - 16 (2.5 - 16)	18	M5 ⊖	2.3 - 2.5 (19.8 - 22)
	B1, B2	2.5	2.5 - 4 (2.5 - 4)	10	M4 ⊖	1.5 - 1.7 (13.5 - 15)
	⊕	2.5	2.5 - 10 (-)	-	M4 ⊕	1.2 - 1.5 (10.6 - 13.3)
2018	R/L1, S/L2, T/L3	2.5	2.5 - 10 (2.5 - 10)	10	M4 ⊖	1.5 - 1.7 (13.5 - 15)
	U/T1, V/T2, W/T3	2.5	2.5 - 10 (2.5 - 10)	10	M4 ⊖	1.5 - 1.7 (13.5 - 15)
	-, +1, +2	4	2.5 - 16 (2.5 - 16)	18	M5 ⊖	2.3 - 2.5 (19.8 - 22)
	B1, B2	2.5	2.5 - 4 (2.5 - 4)	10	M4 ⊖	1.5 - 1.7 (13.5 - 15)
	⊕	2.5	2.5 - 10 (-)	-	M4 ⊕	1.2 - 1.5 (10.6 - 13.3)
2021	R/L1, S/L2, T/L3	6	2.5 - 10 (2.5 - 10)	10	M4 ⊖	1.5 - 1.7 (13.5 - 15)
	U/T1, V/T2, W/T3	2.5	2.5 - 10 (2.5 - 10)	10	M4 ⊖	1.5 - 1.7 (13.5 - 15)
	-, +1, +2	6	2.5 - 16 (2.5 - 16)	18	M5 ⊖	2.3 - 2.5 (19.8 - 22)
	B1, B2	2.5	2.5 - 4 (2.5 - 4)	10	M4 ⊖	1.5 - 1.7 (13.5 - 15)
	⊕	6	4 - 10 (-)	-	M4 ⊕	1.2 - 1.5 (10.6 - 13.3)
2030	R/L1, S/L2, T/L3	10	2.5 - 10 (2.5 - 10)	10	M4 ⊖	1.5 - 1.7 (13.5 - 15)
	U/T1, V/T2, W/T3	6	2.5 - 10 (2.5 - 10)	10	M4 ⊖	1.5 - 1.7 (13.5 - 15)
	-, +1, +2	10	2.5 - 16 (2.5 - 16)	18	M5 ⊖	2.3 - 2.5 (19.8 - 22)
	B1, B2	2.5	2.5 - 4 (2.5 - 4)	10	M4 ⊖	1.5 - 1.7 (13.5 - 15)
	⊕	10	6 - 10 (-)	-	M5 ⊕	2.0 - 2.5 (17.7 - 22.1)
2042	R/L1, S/L2, T/L3	10	2.5 - 10 (2.5 - 10)	10	M4 ⊖	1.5 - 1.7 (13.5 - 15)
	U/T1, V/T2, W/T3	10	2.5 - 10 (2.5 - 10)	10	M4 ⊖	1.5 - 1.7 (13.5 - 15)
	-, +1, +2	16	2.5 - 16 (2.5 - 16)	18	M5 ⊖	2.3 - 2.5 (19.8 - 22)
	B1, B2	4	2.5 - 4 (2.5 - 4)	10	M4 ⊖	1.5 - 1.7 (13.5 - 15)
	⊕	10	6 - 10 (-)	-	M5 ⊕	2.0 - 2.5 (17.7 - 22.1)

5.2 European Standards

Model	Terminal	Recomm. Gauge mm ²	Applicable Gauge (IP20 Applicable Gauge *) mm ²	Wire Stripping Length *2 mm	Terminal Screw Size and Shape	Tightening Torque N·m (lbf·in)
2056	R/L1, S/L2, T/L3	25	2.5 - 25 (10 - 25)	18	M5	2.3 - 2.5 (19.8 - 22)
	U/T1, V/T2, W/T3	16	2.5 - 16 (6 - 16)	18	M5	2.3 - 2.5 (19.8 - 22)
	-, +1, +2	35	2.5 - 35 (10 - 35)	20	M6	5 - 5.5 (45 - 49)
	B1, B2	10	2.5 - 10 (2.5 - 10)	10	M4	1.5 - 1.7 (13.5 - 15)
		16	10 - 16 (-)	-	M6	5.4 - 6.0 (47.8 - 53.1)
2070	R/L1, S/L2, T/L3	35	2.5 - 35 (25 - 35)	20	M6	5 - 5.5 (45 - 49)
	U/T1, V/T2, W/T3	16	2.5 - 16 (16)	20	M6	5 - 5.5 (45 - 49)
	-, +1, +2	50	2.5 - 50 (35 - 50)	20	M6	5 - 5.5 (45 - 49)
	B1, B2	10	2.5 - 10 (2.5 - 10)	10	M4	1.5 - 1.7 (13.5 - 15)
		16	16 - 25 (-)	-	M6	5.4 - 6.0 (47.8 - 53.1)
2082	R/L1, S/L2, T/L3	35	2.5 - 35 (25 - 35)	20	M6	5 - 5.5 (45 - 49)
	U/T1, V/T2, W/T3	25	2.5 - 25 (16 - 25)	20	M6	5 - 5.5 (45 - 49)
	-, +1, +2	50	2.5 - 50 (35 - 50)	20	M6	5 - 5.5 (45 - 49)
	B1, B2	16	2.5 - 16 (2.5 - 16)	10	M4	1.5 - 1.7 (13.5 - 15)
		16	16 - 25 (-)	-	M6	5.4 - 6.0 (47.8 - 53.1)
2110	R/L1, S/L2, T/L3	35	16 - 35 (25 - 35)	27	M6	8 - 9 (71 - 80)
	U/T1, V/T2, W/T3	35	16 - 35 (25 - 35)	27	M6	8 - 9 (71 - 80)
	-, +1	50	25 - 50 (25 - 50)	27	M8	10 - 12 (89 - 107)
	B1, B2	25	6 - 25 (6 - 25)	21	M6	3 - 3.5 (27 - 31)
		16	16 - 25 (-)	-	M6	5.4 - 6.0 (47.8 - 53.1)
2138	R/L1, S/L2, T/L3	50	16 - 50 (50)	27	M6	8 - 9 (71 - 80)
	U/T1, V/T2, W/T3	50	16 - 50 (50)	27	M6	8 - 9 (71 - 80)
	-, +1	70	25 - 70 (50 - 70)	27	M8	10 - 12 (89 - 107)
	B1, B2	35	6 - 35 (6 - 35)	21	M6	3 - 3.5 (27 - 31)
		25	25 (-)	-	M6	5.4 - 6.0 (47.8 - 53.1)

Model	Terminal	Recomm. Gauge mm ²	Applicable Gauge (IP20 Applicable Gauge *) mm ²	Wire Stripping Length *2 mm	Terminal Screw Size and Shape	Tightening Torque N·m (lbf·in)
2169	R/L1, S/L2, T/L3	70	50 - 95 (95)	37	M10	12 - 14 (107 - 124)
	U/T1, V/T2, W/T3	70	50 - 95 (95)	37	M10	12 - 14 (107 - 124)
	-, -, +1, +1 *3 *4	35	16 - 50 (50)	28	M6	8 - 9 (71 - 80)
	+3 *4	50	25 - 70 (50 - 70)	28	M8	8 - 9 (71 - 80)
		35	25 - 50 (-)	-	M8	9.0 - 11 (79.7 - 97.4)
2211	R/L1, S/L2, T/L3	95	50 - 95 (95)	37	M10	12 - 14 (107 - 124)
	U/T1, V/T2, W/T3	95	50 - 95 (95)	37	M10	12 - 14 (107 - 124)
	-, -, +1, +1 *3 *4	50	16 - 50 (50)	28	M6	8 - 9 (71 - 80)
	+3 *4	70	25 - 70 (50 - 70)	28	M8	8 - 9 (71 - 80)
		50	25 - 50 (-)	-	M8	9.0 - 11 (79.7 - 97.4)
2257	R/L1, S/L2, T/L3	50 × 2P	25 - 95 × 2P (70 - 95 × 2P)	-	M10	20 (177)
	U/T1, V/T2, W/T3	50 × 2P	25 - 95 × 2P (70 - 95 × 2P)	-	M10	20 (177)
	-, +1	70 × 2P	35 - 120 × 2P (120 × 2P)	-	M10	20 (177)
	+3	35 × 2P	25 - 70 × 2P (70 × 2P)	-	M10	20 (177)
		95	95 - 240 (-)	-	M10	18 - 23 (159 - 204)
2313	R/L1, S/L2, T/L3	70 × 2P	25 - 95 × 2P (70 - 95 × 2P)	-	M10	20 (177)
	U/T1, V/T2, W/T3	70 × 2P	25 - 95 × 2P (70 - 95 × 2P)	-	M10	20 (177)
	-, +1	95 × 2P	35 - 120 × 2P (120 × 2P)	-	M10	20 (177)
	+3	50 × 2P	25 - 70 × 2P (70 × 2P)	-	M10	20 (177)
		95	95 - 240 (-)	-	M10	18 - 23 (159 - 204)
2360	R/L1, S/L2, T/L3	120 × 2P	70 - 150 × 2P (150 × 2P)	-	M12	35 (310)
	U/T1, V/T2, W/T3	120 × 2P	70 - 150 × 2P (150 × 2P)	-	M12	35 (310)
	-, +1	120 × 2P	95 - 185 × 2P (185 × 2P)	-	M12	35 (310)
	+3	70 × 2P	50 - 95 × 2P (-)	-	M12	35 (310)
		120	120 - 240 (-)	-	M12	32 - 40 (283 - 354)

5.2 European Standards

Model	Terminal	Recomm. Gauge mm ²	Applicable Gauge (IP20 Applicable Gauge *) mm ²	Wire Stripping Length *2 mm	Terminal Screw Size and Shape	Tightening Torque N·m (lbf·in)
2415	R/L1, S/L2, T/L3	120 × 2P	70 - 150 × 2P (150 × 2P)	-	M12	35 (310)
	U/T1, V/T2, W/T3	120 × 2P	70 - 150 × 2P (150 × 2P)	-	M12	35 (310)
	-, +1	120 × 2P	95 - 185 × 2P (185 × 2P)	-	M12	35 (310)
	+3	70 × 2P	50 - 95 × 2P (-)	-	M12	35 (310)
		120	120 - 240 (-)	-	M12	32 - 40 (283 - 354)

*1 For IP20 protection, use wires that are in the range of applicable gauges.

*2 Remove insulation from the ends of wires to expose the length of wire shown.

*3 Terminals - and +1 have two screws. The Recommended Gauge is the wire gauge for one terminal.

*4 A junction terminal is necessary to connect a braking unit (CDBR-series) to terminals - and +3.

Three-Phase 400 V Class

Model	Terminal	Recomm. Gauge mm ²	Applicable Gauge (IP20 Applicable Gauge *) mm ²	Wire Stripping Length *2 mm	Terminal Screw Size and Shape	Tightening Torque N·m (lbf·in)
4002	R/L1, S/L2, T/L3	2.5	2.5 - 10 (2.5 - 10)	10	M4	1.5 - 1.7 (13.5 - 15)
	U/T1, V/T2, W/T3	2.5	2.5 - 10 (2.5 - 10)	10	M4	1.5 - 1.7 (13.5 - 15)
	-, +1, +2	2.5	2.5 - 16 (2.5 - 16)	18	M5	2.3 - 2.5 (19.8 - 22)
	B1, B2	2.5	2.5 - 4 (2.5 - 4)	10	M4	1.5 - 1.7 (13.5 - 15)
		2.5	2.5 - 10 (-)	-	M4	1.2 - 1.5 (10.6 - 13.3)
4004	R/L1, S/L2, T/L3	2.5	2.5 - 10 (2.5 - 10)	10	M4	1.5 - 1.7 (13.5 - 15)
	U/T1, V/T2, W/T3	2.5	2.5 - 10 (2.5 - 10)	10	M4	1.5 - 1.7 (13.5 - 15)
	-, +1, +2	2.5	2.5 - 16 (2.5 - 16)	18	M5	2.3 - 2.5 (19.8 - 22)
	B1, B2	2.5	2.5 - 4 (2.5 - 4)	10	M4	1.5 - 1.7 (13.5 - 15)
		2.5	2.5 - 10 (-)	-	M4	1.2 - 1.5 (10.6 - 13.3)
4005	R/L1, S/L2, T/L3	2.5	2.5 - 10 (2.5 - 10)	10	M4	1.5 - 1.7 (13.5 - 15)
	U/T1, V/T2, W/T3	2.5	2.5 - 10 (2.5 - 10)	10	M4	1.5 - 1.7 (13.5 - 15)
	-, +1, +2	2.5	2.5 - 16 (2.5 - 16)	18	M5	2.3 - 2.5 (19.8 - 22)
	B1, B2	2.5	2.5 - 4 (2.5 - 4)	10	M4	1.5 - 1.7 (13.5 - 15)
		2.5	2.5 - 10 (-)	-	M4	1.2 - 1.5 (10.6 - 13.3)































Model	Terminal	Recomm. Gauge mm ²	Applicable Gauge (IP20 Applicable Gauge *) mm ²	Wire Stripping Length *2 mm	Terminal Screw Size and Shape	Tightening Torque N·m (lbf·in)
4007	R/L1, S/L2, T/L3	2.5	2.5 - 10 (2.5 - 10)	10	M4 ⊖	1.5 - 1.7 (13.5 - 15)
	U/T1, V/T2, W/T3	2.5	2.5 - 10 (2.5 - 10)	10	M4 ⊖	1.5 - 1.7 (13.5 - 15)
	-, +1, +2	2.5	2.5 - 16 (2.5 - 16)	18	M5 ⊖	2.3 - 2.5 (19.8 - 22)
	B1, B2	2.5	2.5 - 4 (2.5 - 4)	10	M4 ⊖	1.5 - 1.7 (13.5 - 15)
	⊕	2.5	2.5 - 10 (-)	-	M4 ⊕	1.2 - 1.5 (10.6 - 13.3)
4009	R/L1, S/L2, T/L3	2.5	2.5 - 10 (2.5 - 10)	10	M4 ⊖	1.5 - 1.7 (13.5 - 15)
	U/T1, V/T2, W/T3	2.5	2.5 - 10 (2.5 - 10)	10	M4 ⊖	1.5 - 1.7 (13.5 - 15)
	-, +1, +2	2.5	2.5 - 16 (2.5 - 16)	18	M5 ⊖	2.3 - 2.5 (19.8 - 22)
	B1, B2	2.5	2.5 - 4 (2.5 - 4)	10	M4 ⊖	1.5 - 1.7 (13.5 - 15)
	⊕	2.5	2.5 - 10 (-)	-	M4 ⊕	1.2 - 1.5 (10.6 - 13.3)
4012	R/L1, S/L2, T/L3	2.5	2.5 - 10 (2.5 - 10)	10	M4 ⊖	1.5 - 1.7 (13.5 - 15)
	U/T1, V/T2, W/T3	2.5	2.5 - 10 (2.5 - 10)	10	M4 ⊖	1.5 - 1.7 (13.5 - 15)
	-, +1, +2	2.5	2.5 - 16 (2.5 - 16)	18	M5 ⊖	2.3 - 2.5 (19.8 - 22)
	B1, B2	2.5	2.5 - 4 (2.5 - 4)	10	M4 ⊖	1.5 - 1.7 (13.5 - 15)
	⊕	2.5	2.5 - 10 (-)	-	M4 ⊕	1.2 - 1.5 (10.6 - 13.3)
4018	R/L1, S/L2, T/L3	2.5	2.5 - 10 (2.5 - 10)	10	M4 ⊖	1.5 - 1.7 (13.5 - 15)
	U/T1, V/T2, W/T3	2.5	2.5 - 10 (2.5 - 10)	10	M4 ⊖	1.5 - 1.7 (13.5 - 15)
	-, +1, +2	4	2.5 - 16 (2.5 - 16)	18	M5 ⊖	2.3 - 2.5 (19.8 - 22)
	B1, B2	2.5	2.5 - 4 (2.5 - 4)	10	M4 ⊖	1.5 - 1.7 (13.5 - 15)
	⊕	2.5	2.5 - 10 (-)	-	M5 ⊕	2.0 - 2.5 (17.7 - 22.1)
4023	R/L1, S/L2, T/L3	6	2.5 - 10 (2.5 - 10)	10	M4 ⊖	1.5 - 1.7 (13.5 - 15)
	U/T1, V/T2, W/T3	4	2.5 - 10 (2.5 - 10)	10	M4 ⊖	1.5 - 1.7 (13.5 - 15)
	-, +1, +2	6	2.5 - 16 (2.5 - 16)	18	M5 ⊖	2.3 - 2.5 (19.8 - 22)
	B1, B2	2.5	2.5 - 4 (2.5 - 4)	10	M4 ⊖	1.5 - 1.7 (13.5 - 15)
	⊕	6	4 - 10 (-)	-	M5 ⊕	2.0 - 2.5 (17.7 - 22.1)































5.2 European Standards

Model	Terminal	Recomm. Gauge mm ²	Applicable Gauge (IP20 Applicable Gauge *) mm ²	Wire Stripping Length *2 mm	Terminal Screw Size and Shape	Tightening Torque N·m (lbf·in)
4031	R/L1, S/L2, T/L3	10	2.5 - 25 (10 - 25)	18	M5	2.3 - 2.5 (19.8 - 22)
	U/T1, V/T2, W/T3	6	2.5 - 16 (6 - 16)	18	M5	2.3 - 2.5 (19.8 - 22)
	-, +1, +2	10	2.5 - 35 (10 - 35)	20	M6	5 - 5.5 (45 - 49)
	B1, B2	2.5	2.5 - 10 (2.5 - 10)	10	M4	1.5 - 1.7 (13.5 - 15)
		10	6 - 16 (-)	-	M6	5.4 - 6.0 (47.8 - 53.1)
4038	R/L1, S/L2, T/L3	10	2.5 - 25 (10 - 25)	18	M5	2.3 - 2.5 (19.8 - 22)
	U/T1, V/T2, W/T3	6	2.5 - 16 (6 - 16)	18	M5	2.3 - 2.5 (19.8 - 22)
	-, +1, +2	16	2.5 - 35 (10 - 35)	20	M6	5 - 5.5 (45 - 49)
	B1, B2	4	2.5 - 10 (2.5 - 10)	10	M4	1.5 - 1.7 (13.5 - 15)
		10	6 - 16 (-)	-	M6	5.4 - 6.0 (47.8 - 53.1)
4044	R/L1, S/L2, T/L3	16	2.5 - 16 (4 - 16)	18	M5	2.3 - 2.5 (19.8 - 22)
	U/T1, V/T2, W/T3	10	2.5 - 10 (6 - 10)	18	M5	2.3 - 2.5 (19.8 - 22)
	-, +1, +2	25	2.5 - 25 (6 - 25)	18	M5	2.3 - 2.5 (19.8 - 22)
	B1, B2	6	2.5 - 6 (2.5 - 6)	10	M4	1.5 - 1.7 (13.5 - 15)
		16	10 - 25 (-)	-	M6	5.4 - 6.0 (47.8 - 53.1)
4060	R/L1, S/L2, T/L3	16	2.5 - 16 (4 - 16)	18	M5	2.3 - 2.5 (19.8 - 22)
	U/T1, V/T2, W/T3	16	2.5 - 16 (6 - 16)	18	M5	2.3 - 2.5 (19.8 - 22)
	-, +1	25	2.5 - 25 (6 - 25)	18	M5	2.3 - 2.5 (19.8 - 22)
	B1, B2	10	2.5 - 10 (2.5 - 10)	10	M4	1.5 - 1.7 (13.5 - 15)
		16	10 - 25 (-)	-	M6	5.4 - 6.0 (47.8 - 53.1)
4075	R/L1, S/L2, T/L3	25	2.5 - 25 (2.5 - 25)	18	M5	2.3 - 2.5 (19.8 - 22)
	U/T1, V/T2, W/T3	25	2.5 - 25 (2.5 - 25)	18	M5	2.3 - 2.5 (19.8 - 22)
	-, +1	25	2.5 - 25 (4 - 25)	18	M5	2.3 - 2.5 (19.8 - 22)
	B1, B2	10	2.5 - 10 (2.5 - 10)	10	M4	1.5 - 1.7 (13.5 - 15)
		16	16 - 25 (-)	-	M6	5.4 - 6.0 (47.8 - 53.1)







Model	Terminal	Recomm. Gauge mm ²	Applicable Gauge (IP20 Applicable Gauge *) mm ²	Wire Stripping Length *2 mm	Terminal Screw Size and Shape	Tightening Torque N·m (lbf·in)
4089	R/L1, S/L2, T/L3	25	2.5 - 25 (10 - 25)	18	M5	2.3 - 2.5 (19.8 - 22)
	U/T1, V/T2, W/T3	25	2.5 - 25 (10 - 25)	18	M5	2.3 - 2.5 (19.8 - 22)
	-, +1	35	2.5 - 35 (16 - 35)	20	M6	5 - 5.5 (45 - 49)
	B1, B2	16	2.5 - 16 (4 - 16)	18	M5	2.3 - 2.5 (19.8 - 22)
		16	16 - 25 (-)	-	M6	5.4 - 6.0 (47.8 - 53.1)
4103	R/L1, S/L2, T/L3	35	16 - 50 (50)	27	M6	8 - 9 (71 - 80)
	U/T1, V/T2, W/T3	35	16 - 50 (50)	27	M6	8 - 9 (71 - 80)
	-, +1	50	25 - 70 (50 - 70)	27	M8	10 - 12 (89 - 107)
	B1, B2	25	6 - 35 (6 - 35)	21	M6	3 - 3.5 (27 - 31)
		16	16 - 25 (-)	-	M6	5.4 - 6.0 (47.8 - 53.1)
4140	R/L1, S/L2, T/L3	50	50 - 95 (95)	37	M10	12 - 14 (107 - 124)
	U/T1, V/T2, W/T3	50	50 - 95 (95)	37	M10	12 - 14 (107 - 124)
	-, -, +1, +1 *3	25	16 - 50 (50)	28	M6	8 - 9 (71 - 80)
	B1, B2 *4	50	25 - 70 (50 - 70)	28	M8	8 - 9 (71 - 80)
		25	25 - 50 (-)	-	M8	9.0 - 11 (79.7 - 97.4)
4168	R/L1, S/L2, T/L3	70	50 - 95 (95)	37	M10	12 - 14 (107 - 124)
	U/T1, V/T2, W/T3	70	50 - 95 (95)	37	M10	12 - 14 (107 - 124)
	-, -, +1, +1 *3	35	16 - 50 (50)	28	M6	8 - 9 (71 - 80)
	B1, B2 *4	50	25 - 70 (50 - 70)	28	M8	8 - 9 (71 - 80)
		35	25 - 50 (-)	-	M8	9.0 - 11 (79.7 - 97.4)
4208	R/L1, S/L2, T/L3	50 × 2P	25 - 95 × 2P (70 - 95 × 2P)	-	M10	20 (177)
	U/T1, V/T2, W/T3	50 × 2P	25 - 95 × 2P (70 - 95 × 2P)	-	M10	20 (177)
	-, +1	70 × 2P	35 - 120 × 2P (120 × 2P)	-	M10	20 (177)
	+3	35 × 2P	25 - 70 × 2P (70 × 2P)	-	M10	20 (177)
		50	50 - 240 (-)	-	M10	18 - 23 (159 - 204)

5.2 European Standards

Model	Terminal	Recomm. Gauge mm ²	Applicable Gauge (IP20 Applicable Gauge *) mm ²	Wire Stripping Length *2 mm	Terminal Screw Size and Shape	Tightening Torque N·m (lbf·in)
4250	R/L1, S/L2, T/L3	50 × 2P	25 - 95 × 2P (70 - 95 × 2P)	-	M10 	20 (177)
	U/T1, V/T2, W/T3	50 × 2P	25 - 95 × 2P (70 - 95 × 2P)	-	M10 	20 (177)
	-, +1	70 × 2P	35 - 120 × 2P (120 × 2P)	-	M10 	20 (177)
	+3	50 × 2P	25 - 70 × 2P (70 × 2P)	-	M10 	20 (177)
		70	70 - 240 (-)	-	M10 	18 - 23 (159 - 204)
4296	R/L1, S/L2, T/L3	70 × 2P	25 - 95 × 2P (70 - 95 × 2P)	-	M10 	20 (177)
	U/T1, V/T2, W/T3	70 × 2P	25 - 95 × 2P (70 - 95 × 2P)	-	M10 	20 (177)
	-, +1	95 × 2P	35 - 120 × 2P (120 × 2P)	-	M10 	20 (177)
	+3	70 × 2P	25 - 70 × 2P (70 × 2P)	-	M10 	20 (177)
		95	95 - 240 (-)	-	M10 	18 - 23 (159 - 204)
4371	R/L1, S/L2, T/L3	120 × 2P	70 - 150 × 2P (150 × 2P)	-	M12 	35 (310)
	U/T1, V/T2, W/T3	120 × 2P	70 - 150 × 2P (150 × 2P)	-	M12 	35 (310)
	-, +1	120 × 2P	95 - 185 × 2P (185 × 2P)	-	M12 	35 (310)
	+3	70 × 2P	50 - 95 × 2P (-)	-	M12 	35 (310)
		120	120 - 240 (-)	-	M12 	32 - 40 (283 - 354)
4389	R/L1, S/L2, T/L3	120 × 2P	70 - 150 × 2P (150 × 2P)	-	M12 	35 (310)
	U/T1, V/T2, W/T3	120 × 2P	70 - 150 × 2P (150 × 2P)	-	M12 	35 (310)
	-, +1	120 × 2P	95 - 185 × 2P (185 × 2P)	-	M12 	35 (310)
	+3	95 × 2P	50 - 95 × 2P (-)	-	M12 	35 (310)
		95	35 - 240 (-)	-	M12 	32 - 40 (283 - 354)
4453	R/L1, S/L2, T/L3	120 × 4P	70 - 150 × 4P (150 × 4P)	-	M12 	35 (310)
	U/T1, V/T2, W/T3	95 × 4P	70 - 150 × 4P (120 - 150 × 4P)	-	M12 	35 (310)
	-, +1	95 × 4P	95 - 185 × 4P (185 × 4P)	-	M12 	35 (310)
	+3	70 × 4P	35 - 95 × 4P (95 × 4P)	-	M12 	35 (310)
		150	50 - 150 (-)	-	M12 	32 - 40 (283 - 354)

Model	Terminal	Recomm. Gauge mm ²	Applicable Gauge (IP20 Applicable Gauge *) mm ²	Wire Stripping Length ^{*)} mm	Terminal Screw Size and Shape	Tightening Torque N·m (lbf·in)
4568	R/L1, S/L2, T/L3	120 × 4P	70 - 150 × 4P (150 × 4P)	-	M12 	35 (310)
	U/T1, V/T2, W/T3	95 × 4P	70 - 150 × 4P (120 - 150 × 4P)	-	M12 	35 (310)
	-, +1	95 × 4P	95 - 185 × 4P (185 × 4P)	-	M12 	35 (310)
	+3	70 × 4P	35 - 95 × 4P (95 × 4P)	-	M12 	35 (310)
		95 × 2P	60 - 150 (-)	-	M12 	32 - 40 (283 - 354)
4675	R/L1, S/L2, T/L3	120 × 4P	70 - 150 × 4P (150 × 4P)	-	M12 	35 (310)
	U/T1, V/T2, W/T3	95 × 4P	70 - 150 × 4P (120 - 150 × 4P)	-	M12 	35 (310)
	-, +1	95 × 4P	95 - 185 × 4P (185 × 4P)	-	M12 	35 (310)
	+3	70 × 4P	35 - 95 × 4P (95 × 4P)	-	M12 	35 (310)
		95 × 2P	60 - 150 (-)	-	M12 	32 - 40 (283 - 354)
4810	R/L1, S/L2, T/L3 R1/L11, S1/L21, T1/L31	120 × 2P × 2	95 - 150 × 2P × 2 (-)	-	M12 	35 (310)
	U/T1, V/T2, W/T3	95 × 2P × 2	70 - 150 × 2P × 2 (-)	-	M12 	35 (310)
	-, +1	150 × 4P	95 - 150 × 4P (-)	-	M12 	35 (310)
	+3	70 × 4P	70 - 150 × 4P (-)	-	M12 	35 (310)
		120 × 2P	70 - 120 (-)	-	M12 	32 - 40 (283 - 354)
4930	R/L1, S/L2, T/L3 R1/L11, S1/L21, T1/L31	120 × 2P × 2	95 - 150 × 2P × 2 (-)	-	M12 	35 (310)
	U/T1, V/T2, W/T3	120 × 2P × 2	95 - 150 × 2P × 2 (-)	-	M12 	35 (310)
	-, +1	150 × 4P	95 - 150 × 4P (-)	-	M12 	35 (310)
	+3	95 × 4P	70 - 150 × 4P (-)	-	M12 	35 (310)
		120 × 2P	70 - 120 (-)	-	M12 	32 - 40 (283 - 354)
4H11	R/L1, S/L2, T/L3 R1/L11, S1/L21, T1/L31	95 × 4P × 2	95 - 150 × 4P × 2 (-)	-	M12 	35 (310)
	U/T1, V/T2, W/T3	50 × 4P × 2	35 - 150 × 4P × 2 (-)	-	M12 	35 (310)
	-, +1	70 × 4P × 2	70 - 150 × 4P × 2 (-)	-	M12 	35 (310)
	+3	35 × 4P × 2	35 - 150 × 4P × 2 (-)	-	M12 	35 (310)
		95 × 4P	95 - 120 (-)	-	M12 	32 - 40 (283 - 354)

5.2 European Standards

Model	Terminal	Recomm. Gauge mm ²	Applicable Gauge (IP20 Applicable Gauge *) mm ²	Wire Stripping Length *2 mm	Terminal Screw Size and Shape	Tightening Torque N·m (lbf·in)
4H12	R/L1, S/L2, T/L3 R1/L11, S1/L21, T1/L31	95 × 4P × 2	95 - 150 × 4P × 2 (-)	-	M12 	35 (310)
	U/T1, V/T2, W/T3	70 × 4P × 2	50 - 150 × 4P × 2 (-)	-	M12 	35 (310)
	-, +1	70 × 4P × 2	70 - 150 × 4P × 2 (-)	-	M12 	35 (310)
	+3	50 × 4P × 2	35 - 150 × 4P × 2 (-)	-	M12 	35 (310)
		95 × 4P	95 - 120 (-)	-	M12 	32 - 40 (283 - 354)







*1 For IP20 protection, use wires that are in the range of applicable gauges.







*2 Remove insulation from the ends of wires to expose the length of wire shown.

*3 Terminals - and +1 have two screws. The Recommended Gauge is the wire gauge for one terminal.

*4 A junction terminal is necessary to connect a braking resistor unit (LKEB-series) to terminals B1 and B2.

6-Phase/12-Pulse 400 V Class

Model	Terminal	Recomm. Gauge *1 mm ²	Applicable Gauge mm ²	Terminal Screw Size and Shape	Tightening Torque N·m (lbf·in)
4810	R/L1, S/L2, T/L3 R1/L11, S1/L21, T1/L31 *2	120 × 2P (×2)	95 - 150	M12 	35 (310)
	U/T1, V/T2, W/T3	95 × 2P × 2	70 - 150	M12 	35 (310)
	-, +1	150 × 4P	95 - 150	M12 	35 (310)
	+3	70 × 4P	70 - 150	M12 	35 (310)
		120 × 2P	70 - 120	M12 	32 - 40 (283 - 354)
4930	R/L1, S/L2, T/L3 R1/L11, S1/L21, T1/L31 *2	120 × 2P (×2)	95 - 150	M12 	35 (310)
	U/T1, V/T2, W/T3	120 × 2P × 2	95 - 150	M12 	35 (310)
	-, +1	150 × 4P	95 - 150	M12 	35 (310)
	+3	95 × 4P	70 - 150	M12 	35 (310)
		120 × 2P	70 - 120	M12 	32 - 40 (283 - 354)
4H11	R/L1, S/L2, T/L3 R1/L11, S1/L21, T1/L31 *2	95 × 4P (×2)	95 - 150	M12 	35 (310)
	U/T1, V/T2, W/T3	50 × 4P × 2	35 - 150	M12 	35 (310)
	-, +1	70 × 4P × 2	70 - 150	M12 	35 (310)
	+3	35 × 4P × 2	35 - 150	M12 	35 (310)
		95 × 4P	95 - 120	M12 	32 - 40 (283 - 354)

Model	Terminal	Recomm. Gauge ^{*1} mm ²	Applicable Gauge mm ²	Terminal Screw Size and Shape	Tightening Torque N·m (lbf·in)
4H12	R/L1, S/L2, T/L3 R1/L11, S1/L21, T1/L31 ^{*2}	95 × 4P (×2)	95 - 150	M12 	35 (310)
	U/T1, V/T2, W/T3	70 × 4P × 2	50 - 150	M12 	35 (310)
	-, +1	70 × 4P × 2	70 - 150	M12 	35 (310)
	+3	50 × 4P × 2	35 - 150	M12 	35 (310)
		95 × 4P	95 - 120	M12 	32 - 40 (283 - 354)

*1 The wire gauges for drive models 4810 to 4H12 are the recommended wire gauges when you use these drive models as a 6-Phase/12-Pulse drive.

*2 When you use drive models 4810 to 4H12 as a 6-Phase/12-Pulse drive, remove the common bus bars on the input terminals.

■ Connect a Fuse to the Input Side (Primary Side)

The drive circuit protection must comply with IEC/EN 61800-5-1 for protection against a short circuit in the internal circuitry. Yaskawa recommends that you install semiconductor protection fuses or ELCBs on the input side for branch circuit protection.

WARNING! Electrical Shock Hazard. After the drive blows a fuse or trips an RCM/RCD, do not immediately energize the drive or operate peripheral devices. Wait for the time specified on the warning label at a minimum and make sure that all indicators are OFF. Then check the wiring and peripheral device ratings to find the cause of the problem. If you do not know the cause of the problem, contact Yaskawa before you energize the drive or peripheral devices. If you do not fix the problem before you operate the drive or peripheral devices, it can cause serious injury or death.

Three-Phase 200 V Class

Table 5.3 Factory-Recommended Branch Circuit Protection (200 V Class)

Drive Model	Semiconductor Protection Fuse Model Manufacturer: EATON/Bussmann	Drive Model	Semiconductor Protection Fuse Model Manufacturer: EATON/Bussmann
2004	FWH-45B	2110	FWH-225A FWH-250A ^{*1}
2006	FWH-45B	2138	FWH-275A FWH-300A ^{*1}
2010	FWH-45B	2169	FWH-275A FWH-350A ^{*1}
2012	FWH-50B	2211	FWH-325A FWH-450A ^{*1}
2018	FWH-80B	2257	FWH-600A
2021	FWH-80B	2313	FWH-800A
2030	FWH-125B	2360	FWH-1000B
2042	FWH-150B	2415	FWH-1000B
2056	FWH-200B		
2070	FWH-225A		
2082	FWH-225A FWH-250A ^{*1}		

*1 Yaskawa recommends a fuse with a large rated current for applications with repeated loads.

Three-Phase 400 V Class

Table 5.4 Factory-Recommended Branch Circuit Protection (400 V Class)

Drive Model	Semiconductor Protection Fuse Model Manufacturer: EATON/Bussmann	Drive Model	Semiconductor Protection Fuse Model Manufacturer: EATON/Bussmann
4002	FWH-50B	4018	FWH-80B
4004	FWH-50B	4023	FWH-90B
4005	FWH-50B	4031	FWH-150B
4007	FWH-60B	4038	FWH-200B
4009	FWH-60B	4044	FWH-200B
4012	FWH-60B	4060	FWH-225A

5.2 European Standards

Drive Model	Semiconductor Protection Fuse Model Manufacturer: EATON/Bussmann
4075	FWH-250A
4089	FWH-275A
4103	FWH-275A
4140	FWH-300A
4168	FWH-325A FWH-400A *1
4208	FWH-500A
4250	FWH-600A
4296	FWH-700A
4371	FWH-800A

Drive Model	Semiconductor Protection Fuse Model Manufacturer: EATON/Bussmann
4389	FWH-1000B
4453	FWH-1200B
4568	FWH-1200B
4675	FWH-1400A FWH-1600A *1
4810	FWH-1200B
4930	FWH-1200B
4H11	FWH-1600A
4H12	FWH-1600A

*1 Yaskawa recommends a fuse with a large rated current for applications with repeated loads.

6-Phase/12-Pulse 400 V Class

Table 5.5 Factory-Recommended Branch Circuit Protection (6-Phase/12-Pulse 400 V Class)

Drive Model	Semiconductor Protection Fuse Model Manufacturer: EATON/Bussmann
4810	FWH-1000B
4930	FWH-1000B

Drive Model	Semiconductor Protection Fuse Model Manufacturer: EATON/Bussmann
4H11	FWH-1200B
4H12	FWH-1200B

■ CE Standards Compliance for DC Power Supply Input

To comply with CE Standards, install a fuse for the DC power supply input.

Figure 5.4 shows a wiring example for a DC power supply that has two drives connected in parallel.

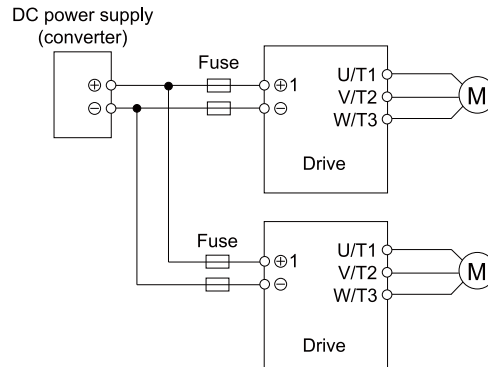

Figure 5.4 Wiring Example for DC Power Supply Input

WARNING! Electrical Shock Hazard. Do not ground the main circuit bus. Incorrect wiring can cause serious injury or death.

Note:

- On models 4810 to 4H12, use DC power supply input terminals +1 and - to connect a PWM converter that can do protection coordination on the input side, for example a Yaskawa D1000-series Power Regenerative Converter. You cannot use a DC power supply to connect drives in parallel.
- Install a fuse for each drive when operating more than one drive. If one fuse blows, replace all fuses.
- Install the external filter (system) to comply with the EMC Directive.

Refer to Table 5.6 and Table 5.7 for the recommended fuses.

Table 5.6 Recommended Fuse (Three-Phase 200 V Class)

Drive Model	Fuse Manufacturer: Bussmann	
	Model	Qty
2004	FWH-45B	2
2006	FWH-45B	2
2010	FWH-45B	2
2012	FWH-50B	2

Drive Model	Fuse Manufacturer: Bussmann	
	Model	Qty
2018	FWH-80B	2
2021	FWH-80B	2
2030	FWH-125B	2
2042	FWH-150B	2

Drive Model	Fuse Manufacturer: Bussmann	
	Model	Qty
2056	FWH-200B	2
2070	FWH-250A	2
2082	FWH-250A FWH-300A ^{*1}	2
2110	FWH-250A FWH-275A ^{*1}	2
2138	FWH-300A FWH-350A ^{*1}	2
2169	FWH-350A FWH-450A ^{*1}	2

Drive Model	Fuse Manufacturer: Bussmann	
	Model	Qty
2211	FWH-450A FWH-600A ^{*1}	2
2257	FWH-600A FWH-700A ^{*1}	2
2313	FWH-800A FWH-1000B ^{*1}	2
2360	FWH-1000B	2
2415	FWH-1000B	2

*1 Yaskawa recommends a fuse with a large rated current for applications with repeated loads.

Table 5.7 Recommended Fuse (Three-Phase 400 V Class)

Drive Model	Fuse Manufacturer: Bussmann	
	Model	Qty
4002	FWH-50B	2
4004	FWH-50B	2
4005	FWH-50B	2
4007	FWH-60B	2
4009	FWH-60B	2
4012	FWH-60B	2
4018	FWH-80B	2
4023	FWH-90B	2
4031	FWH-150B	2
4038	FWH-200B	2
4044	FWH-200B	2
4060	FWH-225A	2
4075	FWH-250A	2
4089	FWH-275A	2
4103	FWH-275A	2
4140	FWH-300A FWH-325A ^{*1}	2
4168	FWH-400A FWH-450A ^{*1}	2

Drive Model	Fuse Manufacturer: Bussmann	
	Model	Qty
4208	FWH-500A FWH-600A ^{*1}	2
4250	FWH-600A FWH-700A ^{*1}	2
4296	FWH-700A FWH-800A ^{*1}	2
4371	FWH-800A FWH-1000B ^{*1}	2
4389	FWH-1000B FWH-1200B ^{*1}	2
4453	FWH-1200B FWH-1400A ^{*1}	2
4568	FWH-1200B FWH-1600A ^{*1}	2
4675	FWH-1600A	2
4810	- ^{*2}	-
4930	- ^{*2}	-
4H11	- ^{*2}	-
4H12	- ^{*2}	-

*1 Yaskawa recommends a fuse with a large rated current for applications with repeated loads.

*2 It is not necessary to install fuses. On models 4810 to 4H12, use DC power supply input terminals +1 and - to connect a PWM converter that can do protection coordination on the input side, for example a Yaskawa D1000-series Power Regenerative Converter.

■ Braking Unit Connection Wire Gauge (CDBR-Type)

When you connect a braking unit (CDBR-type) to drive models 2257 to 2415 or 4208 to 4H12, refer to [Table 5.8](#) and [Table 5.9](#) to select the wires.

Table 5.8 200 V Class

Drive Model	Braking Unit (Qty)	Drive Terminals	Recomm. Gauge (mm ²)	Applicable Gauge (mm ²)
2257	CDBR-2022D (× 2) Specified Wire Gauge	+3	6 × 2P	6 - 10 × 2P
		-	6 × 2P	6 - 10 × 2P
	Applicable Gauge ^{*1}	+3	35 × 2P	25 - 70 × 2P
		-	35 × 2P ^{*2}	25 - 70 × 2P ^{*2}
2313	CDBR-2110D (× 1) Specified Wire Gauge	+3	35	35
		-	35	35
	Applicable Gauge ^{*1}	+3	50 × 2P	25 - 70 × 2P
		-	50 × 2P ^{*2}	25 - 70 × 2P ^{*2}
2360	CDBR-2110D (× 1) Specified Wire Gauge	+3	35	35
		-	35	35
2415	CDBR-2110D (× 1) Specified Wire Gauge	+3	35	35
		-	35	35

*1 This is the applicable wire gauge when you do not use a Yaskawa braking unit (CDBR-type).

*2 This is the applicable wire gauge when you use the same wires for terminal - and terminal +3.

Table 5.9 400 V Class

Drive Model	Braking Unit (Qty)	Drive Terminals	Recomm. Gauge (mm ²)	Applicable Gauge (mm ²)
4208	CDBR-4045D (× 2) Specified Wire Gauge	+3	6 × 2P	6 - 10 × 2P
		-	6 × 2P	6 - 10 × 2P
	Applicable Gauge ^{*1}	+3	35 × 2P	25 - 70 × 2P
		-	35 × 2P ^{*2}	25 - 70 × 2P ^{*2}
4250	CDBR-4220D (× 1) Specified Wire Gauge	+3	35	35
		-	35	35
	Applicable Gauge ^{*1}	+3	50 × 2P	25 - 70 × 2P
		-	50 × 2P ^{*2}	25 - 70 × 2P ^{*2}
4296	CDBR-4220D (× 1) Specified Wire Gauge	+3	35	35
		-	35	35
	Applicable Gauge ^{*1}	+3	70 × 2P	25 - 70 × 2P
		-	70 × 2P ^{*2}	25 - 70 × 2P ^{*2}
4371	CDBR-4220D (× 1) Specified Wire Gauge	+3	35	35
		-	35	35
4389	CDBR-4220D (× 1) Specified Wire Gauge	+3	35	35
		-	35	35
4453	CDBR-4220D (× 1) Specified Wire Gauge	+3	35	35
		-	35	35
	Applicable Gauge ^{*1}	+3	70 × 4P	35 - 95 × 4P
		-	70 × 4P ^{*2}	35 - 95 × 4P ^{*2}
4568	CDBR-4220D (× 1) Specified Wire Gauge	+3	35	35
		-	35	35
	Applicable Gauge	+3	70 × 4P	35 - 95 × 4P
		-	70 × 4P ^{*2}	35 - 95 × 4P ^{*2}

Drive Model	Braking Unit (Qty)	Drive Terminals	Recomm. Gauge (mm ²)	Applicable Gauge (mm ²)
4675	CDBR-4220D (× 2) Specified Wire Gauge	+3	35 × 2P	35 × 2P
		-	35 × 2P	35 × 2P
	Applicable Gauge *1	+3	70 × 4P	35 - 95 × 4P
		-	70 × 4P *2	35 - 95 × 4P *2

*1 This is the applicable wire gauge when you do not use a Yaskawa braking unit (CDBR-type).

*2 This is the applicable wire gauge when you use the same wires for terminal - and terminal +3.

◆ Electromagnetic Compatibility Regulations

Drives with built-in EMC filters (models 2xxxB, 2xxxC, 4xxxB, 4xxxC) were tested in accordance with European standard EN 61800-3, and comply with the EMC Directive.

Use drives with built-in EMC filters or install external EMC filters to the drive input side to comply with the EMC Directive. Refer to [Installing the External EMC Noise Filter on page 254](#) for the installation of the EMC filter.

■ Install a Drive to Conform to the EMC Directive

Install drive models 2xxxB, 2xxxC, 4xxxB, and 4xxxC with this procedure to comply with the EMC Directive when the drive is a single unit or installed in a larger device.

1. Install the drive on a grounded metal plate.
2. Wire the drive and motor.
3. Ground the wire shielding on the drive side and motor side.

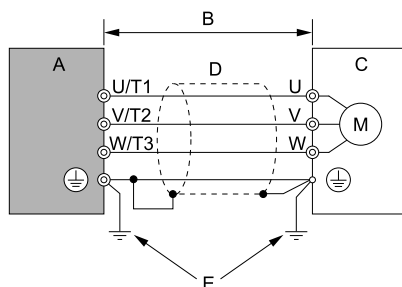

A - Drive

B - 10 m (32.8 ft) maximum

C - Motor

D - Metal conduit

E - Grounding wire

Figure 5.5 Wiring the Drive and Motor

Note:

- Use a braided shield cable for the drive and motor wiring or put the wires through a metal conduit.
- The maximum wiring length between the drive and motor is 10 m (32.8 ft). Keep the wire as short as possible.
- Keep the grounding wire as short as possible.

4. Use a cable clamp to ground the motor cable to the metal plate.

Note:

Make sure that the protective ground wire complies with technical specifications and local safety standards.

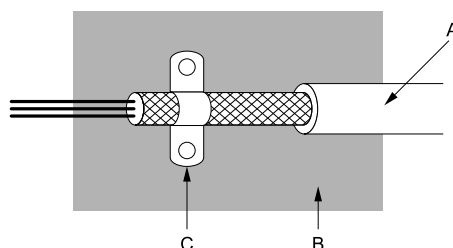

A - Braided shield cable

B - Metal plate

C - Cable clamp (conductive)

Figure 5.6 Ground the Shield

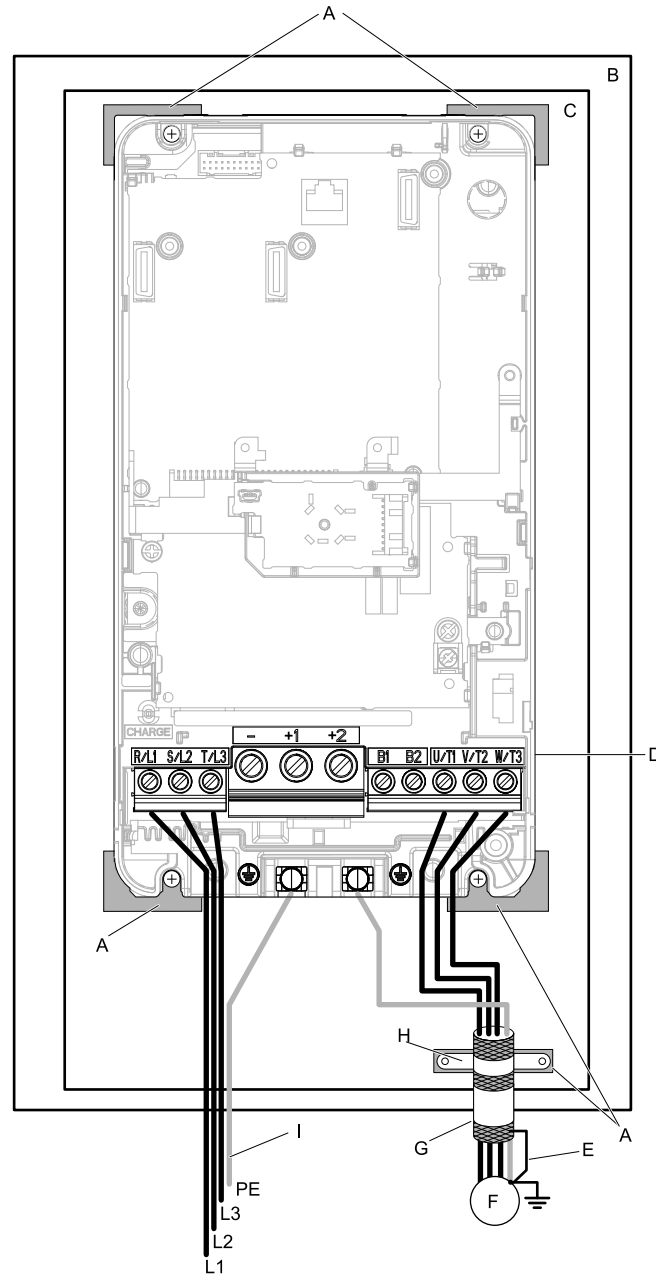

- | | |
|---|---------------------------|
| A - Grounding surface (Remove any paint or sealant.) | F - Motor |
| B - Enclosure panel | G - Motor cable |
| C - Metal plate | H - Cable clamp |
| D - Drive | I - Grounding wire |
| E - Shielded wire | |

Figure 5.7 Install a Drive with a Built-in EMC Filter

- To maintain compliance with IEC/EN 61000-3-2 on drive models 2004, 4002, and 4004, install an AC reactor or a DC reactor. Refer to [DC Reactor on page 258](#) to select a DC reactor.

Note:

- Ground the DC reactor (option) on the back of the mounting base. Remove all paint from the mounting surface of the control panel.

Ground Wiring

WARNING! Electrical Shock Hazard. Do not remove covers or touch circuit boards while the drive is energized. If you touch the internal components of an energized drive, it can cause serious injury or death.

WARNING! Electrical Shock Hazard. Ground the neutral point on the power supply of drive models 2xxxB/C and 4xxxB/C to comply with the EMC Directive before you turn on the EMC filter. If you turn ON the EMC filter, but you do not ground the neutral point, it can cause serious injury or death.

Enable the Internal EMC Filter

On drive models 2xxxB, 2xxxC, 4xxxB, and 4xxxC, move the screw or screws to turn ON and OFF (enable and disable) the EMC filter.

Make sure that the symmetric grounding network is applied, and install the screw or screws in the ON position to enable the built-in EMC filter in compliance with the EMC Directive. The EMC filter switch screw or screws are installed in the OFF position by default.

WARNING! Electrical Shock Hazard. Disconnect all power to the drive, wait for the time specified on the warning label, and check the drive for dangerous voltages before you remove covers or touch EMC filter screws. If you touch the screws when there are dangerous voltages, it will cause serious injury or death.

WARNING! Electrical Shock Hazard. Do not remove covers or touch circuit boards while the drive is energized. If you touch the internal components of an energized drive, it can cause serious injury or death.

WARNING! Electrical Shock Hazard. Ground the neutral point on the power supply of drive models 2xxxB/C and 4xxxB/C to comply with the EMC Directive before you turn on the EMC filter. If you turn ON the EMC filter, but you do not ground the neutral point, it can cause serious injury or death.

WARNING! Electrical Shock Hazard. Connect the ground cable correctly. If you touch electrical equipment that is not grounded, it can cause serious injury or death.

NOTICE: To disable the internal EMC filter, move the screws from ON to OFF and then tighten to the specified torque. If you fully remove the screws or tighten the screws to an incorrect torque, it can cause drive failure.

NOTICE: Move the EMC switch screw or screws to the OFF position for networks that are not symmetrically grounded. If the screws are not in the correct position, it can cause damage to the drive.

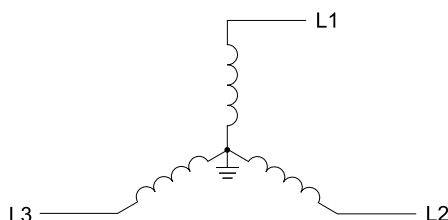

Figure 5.8 Symmetric Grounding

NOTICE: Damage to Equipment. When you use the drive with a non-grounding, high-resistance grounding, or asymmetric-grounding network, put the EMC Filter screw or screws in the OFF position to disable the built-in EMC filter. If you do not disable the built-in EMC filter, it will cause damage to the drive.

Table 5.10 shows asymmetric grounding networks.

Table 5.10 Asymmetric Grounding

Type of Grounding	Diagram
Grounded at the corner of the delta connection	<p>The diagram shows a three-phase winding connected in a delta configuration. One of the three corners of the delta is connected to a ground symbol. The phases are labeled L1, L2, and L3.</p>
Grounded at the middle of the side	<p>The diagram shows a three-phase winding connected in a delta configuration. One of the three sides of the delta is connected to a ground symbol. The phases are labeled L1, L2, and L3.</p>
Single-phase, grounded at the end point	<p>The diagram shows a single-phase winding connected between two terminals, L1 and N. The terminal N is connected to a ground symbol.</p>
Three-phase variable transformer without solidly grounded neutral	<p>The diagram shows a three-phase variable transformer with three windings. The top winding is labeled L1, the middle winding is labeled L2, and the bottom winding is labeled L3. Each winding has a tap point labeled with the same letter (L1, L2, L3) and an arrow pointing to the tap.</p>

Table 5.11 EMC Filter Switch Location

Model	Switch Location Diagram
2004B - 2042B, 4002B - 4023B 2004C - 2042C, 4002C - 4023C	Figure 5.9
2056B, 4031B, 4038B 2056C, 4031C, 4038C	Figure 5.10
2070B, 2082B, 4044B, 4060B 2070C, 2082C, 4044C, 4060C	Figure 5.11
2110B, 4075B, 2138B - 2211B, 4089B - 4168B 2110C, 4075C, 2138C - 2211C, 4089C - 4168C	Figure 5.12
2257B - 2313B, 4208B - 4296B 2257C - 2313C, 4208C - 4296C	Figure 5.13
2360B, 2415B, 4371B, 4389B 2360C, 2415C, 4371C, 4389C	Figure 5.14
4453B - 4675B 4453C - 4675C	Figure 5.15

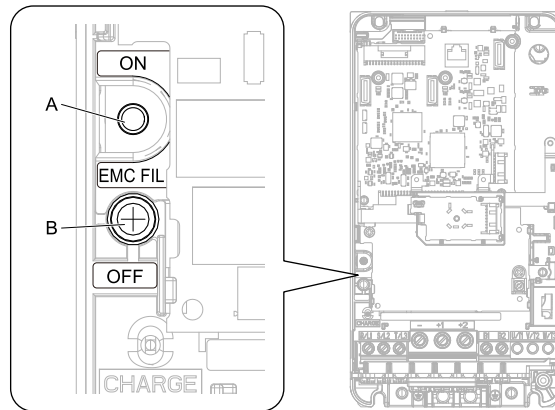

A - SW (ON)

B - Screw (OFF)

Figure 5.9 EMC Filter Switch Location 1

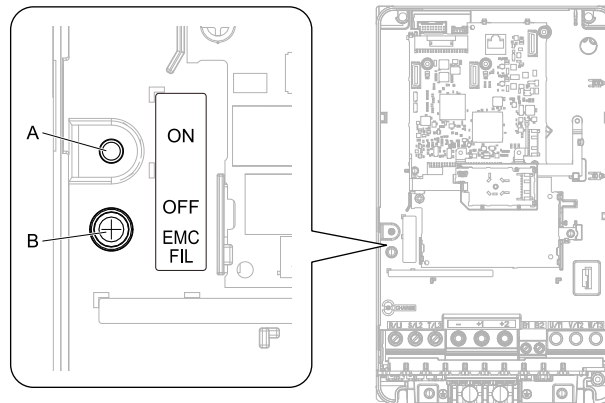

A - SW (ON)

B - Screw (OFF)

Figure 5.10 EMC Filter Switch Location 2

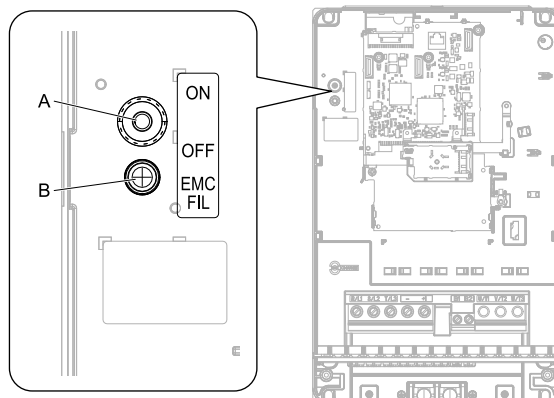

A - SW (ON)

B - Screw (OFF)

Figure 5.11 EMC Filter Switch Location 3

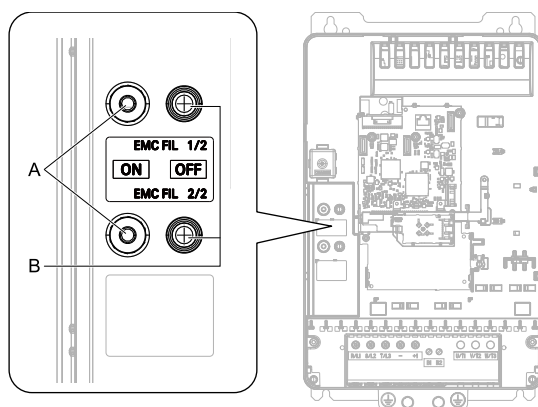

A - SW (ON)

B - Screw (OFF)

Figure 5.12 EMC Filter Switch Location 4

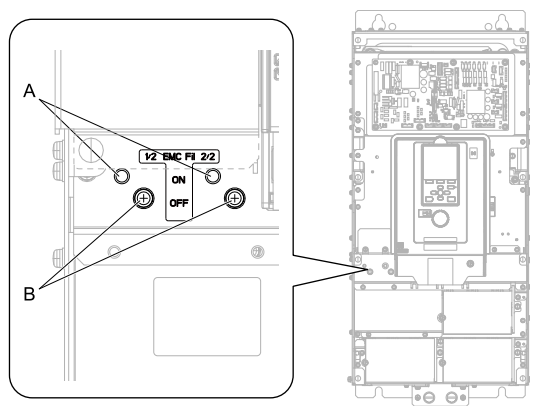

A - SW (ON)

B - Screw (OFF)

Figure 5.13 EMC Filter Switch Location 5

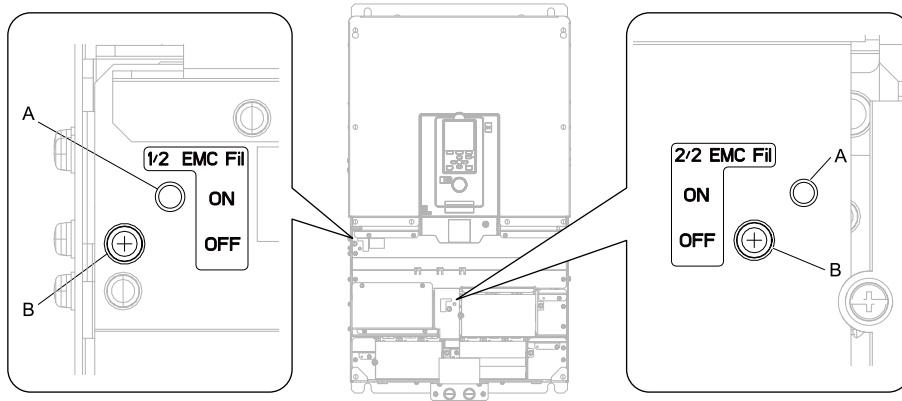

A - SW (ON)

B - Screw (OFF)

Figure 5.14 EMC Filter Switch Location 6

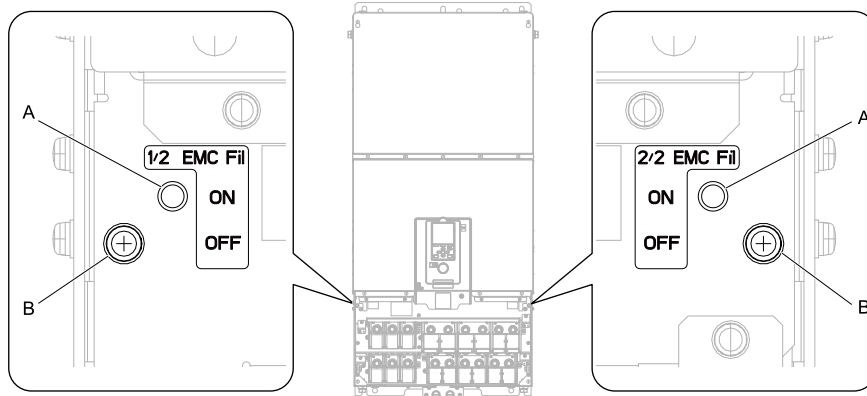

A - SW (ON)

B - Screw (OFF)

Figure 5.15 EMC Filter Switch Location 7

If you lose an EMC filter switch screw, use [Table 5.12](#) to find the correct replacement screw and install the new screw with the correct tightening torque.

NOTICE: Only use the screws specified in this manual. If you use screws that are not approved, it can cause damage to the drive.

Table 5.12 Screw Sizes and Tightening Torques

Model	Screw Size	Tightening Torque N·m
2004 - 2082, 4002 - 4060	M4 × 20	1.0 - 1.3
2110 - 2211, 4075 - 4168	M4 × 25	1.0 - 1.3
2257 - 2415, 4208 - 4675	M5 × 25	2.0 - 2.5

■ Installing the External EMC Noise Filter

Drive models 2xxxA and 4xxxA must meet conditions in this section to comply with EN 61800-3.

Connect an EMC noise filter that complies with European standards as specified by Yaskawa to the input side (primary side). Refer to [External EMC Noise Filter Selection on page 257](#) to select the correct EMC noise filter.

Use this procedure to install an EMC noise filter to make equipment and devices added to the drive comply with the EMC Directive.

1. Install the drive and EMC noise filter on the same grounded metal plate.
2. Wire the drive and motor.

3. Ground the wire shielding on the drive side and motor side.

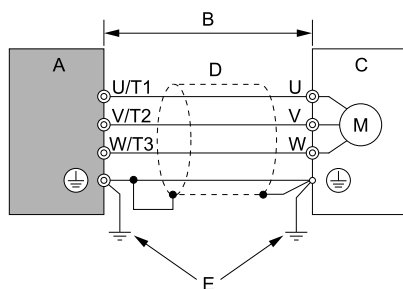

A - Drive

B - 10 m (32.8 ft) maximum

C - Motor

D - Metal conduit

E - Grounding wire

Figure 5.16 Wiring the Drive and Motor

Note:

- Use a braided shield cable for the drive and motor wiring or put the wires through a metal conduit.
- The maximum wiring length between the drive and motor is 10 m (32.8 ft). Keep the wire as short as possible.
- Keep the grounding wire as short as possible.

4. Use a cable clamp to ground the motor cable to the metal plate.

Note:

Make sure that the protective ground wire complies with technical specifications and local safety standards.

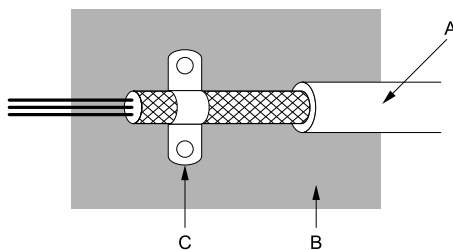

A - Braided shield cable

B - Metal plate

C - Cable clamp (conductive)

Figure 5.17 Ground the Shield

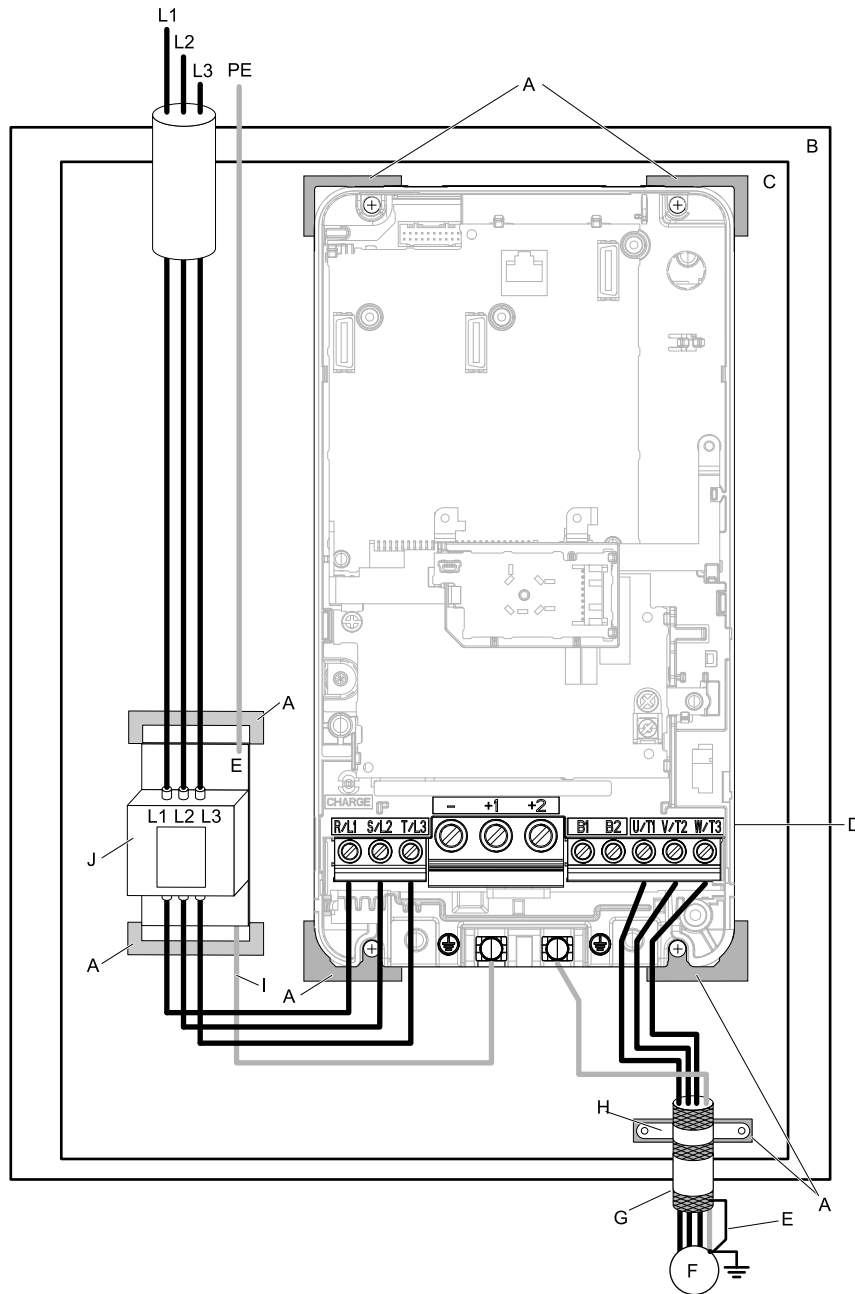

- | | |
|---|--|
| <p>A - Grounding surface (Remove any paint or sealant.)</p> <p>B - Enclosure panel</p> <p>C - Metal plate</p> <p>D - Drive</p> <p>E - Ground the shield.</p> | <p>F - Motor</p> <p>G - Motor cable (Braided shield cable: 10 m (32.8 ft) maximum)</p> <p>H - Cable clamp</p> <p>I - Grounding wire</p> <p>J - EMC noise filter</p> |
|---|--|

Figure 5.18 EMC Noise Filter and Drive Installation Procedure

- To maintain compliance with IEC/EN 61000-3-2 on drive models 2004, 4002, and 4004, install an AC reactor or a DC reactor. Refer to [DC Reactor on page 258](#) to select a DC reactor.

Note:

- Ground the DC reactor (option) on the back of the mounting base. Remove all paint from the mounting surface of the control panel.

Ground Wiring

WARNING! Electrical Shock Hazard. Do not remove covers or touch circuit boards while the drive is energized. If you touch the internal components of an energized drive, it can cause serious injury or death.

WARNING! Electrical Shock Hazard. Ground the neutral point on the power supply of drive models 2xxxB/C and 4xxxB/C to comply with the EMC Directive before you turn on the EMC filter. If you turn ON the EMC filter, but you do not ground the neutral point, it can cause serious injury or death.

External EMC Noise Filter Selection

Table 5.13 External EMC Noise Filter (2xxxA)

Model	EMC Noise Filter Model	Qty	Manufacturer
2004A	RTEN-5006	1	TDK
2006A	RTEN-5010	1	TDK
2010A	RTEN-5020	1	TDK
2012A	RTEN-5020	1	TDK
2018A	RTEN-5030	1	TDK
2021A	RTEN-5030	1	TDK
2030A	RTEN-5060	1	TDK
2042A	RTEN-5060	1	TDK
2056A	RTEN-5080	1	TDK
2070A	FS5972-100-35	1	Schaffner
2082A	FS5972-100-35	1	Schaffner
2110A	FS5972-170-40	1	Schaffner
2138A	FS5972-170-40	1	Schaffner
2169A	FS5972-170-40	1	Schaffner
2211A	FS5972-250-37	1	Schaffner
2257A	FS5972-410-99	1	Schaffner
2313A	FS5972-410-99	1	Schaffner
2360A	FS5972-410-99	1	Schaffner
2415A	FS5972-600-99	1	Schaffner

Table 5.14 External EMC Noise Filter (4xxxA)

Model	EMC Noise Filter Model	Qty	Manufacturer
4002A	B84143A0010R106	1	TDK
4004A	B84143A0010R106	1	TDK
4005A	B84143A0010R106	1	TDK
4007A	B84143A0010R106	1	TDK
4009A	B84143A0020R106	1	TDK
4012A	B84143A0020R106	1	TDK
4018A	B84143A0035R106	1	TDK
4023A	B84143A0035R106	1	TDK
4031A	B84143A0050R106	1	TDK
4038A	B84143A0065R106	1	TDK
4044A	B84143A0065R106	1	TDK
4060A	B84143A0065R106	1	TDK
4075A	B84143A0080R106	1	TDK
4089A	FS5972-100-35	1	Schaffner
4103A	FS5972-170-40	1	Schaffner
4140A	FS5972-170-40	1	Schaffner
4168A	FS5972-170-40	1	Schaffner
4208A	FS5972-250-37	1	Schaffner
4250A	FS5972-250-37	1	Schaffner
4296A	FS5972-410-99	1	Schaffner
4371A	FS5972-410-99	1	Schaffner
4389A	FS5972-410-99	1	Schaffner
4453A	FS5972-600-99	1	Schaffner

5.2 European Standards

Model	EMC Noise Filter Model	Qty	Manufacturer
4568A	FS5972-600-99	1	Schaffner
4675A	FS5972-410-99	2	Schaffner
4810A	FS5972-600-99	2	Schaffner
4930A	FS5972-600-99	2	Schaffner
4H11A	FS5972-800-99	2	Schaffner
4H12A	FS5972-800-99	2	Schaffner

■ DC Reactor

To comply with IEC/EN 61000-3-2, install a DC reactor to drive models 2004, 2006, 4002, and 4004 when using an internal or external EMC filter. Refer to [Table 5.15](#) to select the correct DC reactor.

Table 5.15 DC Reactors for Harmonic Suppression (Manufacturer: Yaskawa Electric)

Drive Model	DC Reactor Model	DC Reactor Rating
2004	UZDA-B	5.4 A, 8 mH
2006	UZDA-B	5.4 A, 8 mH
4002	UZDA-B	3.2 A, 28 mH
4004	UZDA-B	3.2 A, 28 mH

5.3 United Kingdom Conformity Assessed Marking



Figure 5.19 United Kingdom Conformity Assessed Marking

The UKCA Mark identifies that the product meets environmental and safety standards in the United Kingdom. Products manufactured, sold, or imported into Great Britain must display the UKCA Mark.

United Kingdom standards include the Electrical Equipment (Safety) Regulations (Low voltage) for electronics manufacturers, the Electromagnetic Compatibility Regulations (EMC) for controlling noise, and the Supply of Machinery (Safety) Regulations (Machinery) for machine manufacturers.

This product displays the UKCA Mark in accordance with the Low Voltage Directive, the EMC Directive, and the Machinery Directive.

Table 5.16 Designated Standards

Statutory Instruments	Designated Standards
Electrical Equipment (Safety) Regulations S.I. 2016 No. 1101	EN 61800-5-1 ^{*1}
Electromagnetic Compatibility Regulations S.I. 2016 No. 1091	EN 61800-3 ^{*1}
Supply of Machinery (Safety) Regulations S.I. 2008 No. 1597	EN ISO 13849-1:2015 (PL e (Cat.III)) EN 62061 (SILCL3) ^{*1} EN 61800-5-2 (SIL3) ^{*1}
Restriction of the Use of Certain Hazardous Substances in Electrical and Electronic Equipment Regulations S.I. 2012 No. 3032	EN IEC 63000 ^{*1}

*1 Refer to "UK Declaration of Conformity" for the year of the Designated Standards.

The customer must display the UKCA Mark on the final device containing this product. Customers must verify that the final device complies with UK standards.

Table 5.17 Other Applicable Standards

Statutory Instruments	Applicable Standards
Ecodesign for Energy-Related Products and Energy Information Regulations S.I. 2021 No. 745	The drive meets the requirements for IEC2 efficiency according to the S.I. 2021 No. 745. The losses and the efficiency were determined in accordance with IEC 61800-9-2.

5.4 UL Standards



Figure 5.20 UL/cUL Mark

The UL/cUL Mark identifies that this product conforms to rigid safety standards. This mark appears on products in the United States and Canada. It shows UL approval, which identifies that the product complies with safety standards after careful inspection and assessment. You must use UL Listed or UL Recognized parts for all primary components that are built into electrical equipment that has UL approval.

This product has been tested in accordance with UL standard UL 61800-5-1, and has been verified to be in compliance with UL standards.

Machines and devices integrated with this product must satisfy the following conditions for compliance with UL standards:

◆ Area of Use

Install this product in a location with Overvoltage Category III and pollution degree 2 or less as specified in UL 61800-5-1.

■ Ambient Temperature Setting

Maintain the ambient temperature within the following ranges according to the enclosure type.

- IP00/UL Open Type: -10 °C to +50 °C (14 °F to 122 °F)
- IP20/UL Open Type: -10 °C to +50 °C (14 °F to 122 °F)
- IP20/UL Type 1: -10 °C to +40 °C (14 °F to 104 °F)
- IP55/UL Type 12 Heatsink External Mounting; front side: -10 °C to +50 °C (14 °F to 122 °F)
- IP55/UL Type 12 Heatsink External Mounting; back side: -10 °C to +40 °C (14 °F to 104 °F)

◆ Wire the Main Circuit Terminal Block

Wire the main circuit terminal block correctly as specified by the instructions in the manual.

To comply with UL standards on drive models 2257 to 2415 and 4208 to 4H12, use UL Listed closed-loop crimp terminals. Use the tools recommend by the terminal manufacturer to crimp the closed-loop crimp terminal. Refer to [Closed-Loop Crimp Terminals on page 273](#) for more information about UL Listed closed-loop crimp terminals. To select the correct wire gauge, refer to [Three-Phase 200 V Class on page 263](#) and [Three-Phase 400 V Class on page 267](#).

■ Notes on Wiring the Main Circuit Terminal Block

Read these notes before you wire the main circuit terminal block.

- Use UL-Listed, vinyl-coated insulated copper wires for operation with a continuous maximum permitted temperature of 75 °C at 600 V.
- Remove all unwanted objects that are near the terminal block connections.
- Remove the insulation from the connection wires to the wire stripping lengths shown in the manual.
- Do not use bent or crushed wires. Remove the damaged end of the wire before you use it. Incorrect connections can cause death or serious injury from fire.
- Do not solder stranded wire. Soldered wire connections can become loose over time and cause unsatisfactory drive performance.
- If you use stranded wire, make sure that all of the wire strands are in the connection. Also, do not twist the stranded wire too much. Incorrect connections can cause death or serious injury from fire.
- Put the wire all the way into the terminal block. Remove the insulation from the wire to the recommended wire stripping length to fit the wire with insulation in the plastic housing.
- Use a torque driver, torque ratchet, or torque wrench for the screws. A slotted driver or a hex tool will be necessary to wire the screw clamp terminal. Use applicable tools as specified by the recommended conditions in the product manual.

- If you use power tools to tighten the terminal screws, use a low speed setting (300 to 400 r/min). Failure to obey can cause damage to the terminal screws.
- Wire gauges on existing drive models to be replaced may not match wire gauge ranges on new drives. Refer to the drive manuals for correct wire sizes.
- Do not tighten the terminal screws at an angle of 5 degrees or more. Failure to obey can cause damage to the terminal screws.
- If you damage a terminal screw, contact Yaskawa or your nearest sales representative.

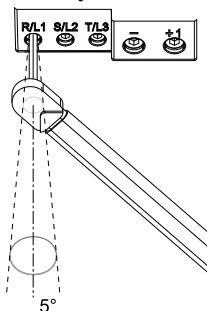

Figure 5.21 Permitted Angle

- Put the bit all the way into the hex socket to tighten the hex socket cap screw.
- When you tighten slotted screws, hold the straight-edge screwdriver perpendicularly to the screw. Make sure that you align the end of the straight-edge screwdriver with the screw groove.

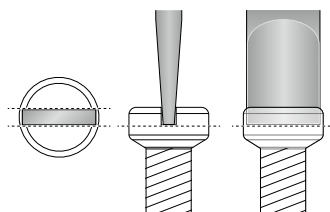
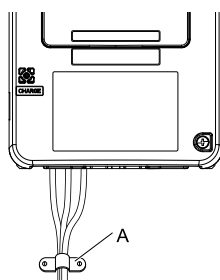

Figure 5.22 Tightening Slotted Screws

- After you connect the wires to the terminal block, lightly pull on the wires to make sure that they do not come out of the terminals.
- Remove the correct section of the wiring cover to make wiring easier.
- Do not let strain on the wiring cause damage. Use a strain relief near the wiring to release the tension. Refer to [Figure 5.23](#) for an example.



A - Cable clamp

Figure 5.23 Strain Relief Example

Table 5.18 Recommended Wiring Tools

Screw Size	Screw Shape	Adapter	Bit		Torque Driver Model (Tightening Torque)	Torque Wrench
			Model	Manufacturer		
M4		Bit	SF-BIT-SL 1,0X4,0-70	PHOENIX CONTACT	TSD-M 3NM (1.2 - 3 N·m (10.6 - 26.6 lbf·in))	N/A
M5 ^{*1}		Bit	SF-BIT-SL 1,2X6,5-70	PHOENIX CONTACT	Wire Gauge ≤ 25 mm ² (AWG 10): TSD-M 3NM (1.2 - 3 N·m (10.6 - 26.6 lbf·in))	Wire Gauge ≤ 25 mm ² (AWG 10): N/A
					Wire Gauge ≥ 30 mm ² (AWG 8): N/A	Wire Gauge ≥ 30 mm ² (AWG 8): 4.1 - 4.5 N·m (36.3 - 39.8 lbf·in) ^{*2} _{^{*3}}
M6		Bit	SF-BIT-HEX 5-50	PHOENIX CONTACT	N/A	5 - 9 N·m (44.3 - 79.9 lbf·in) ^{*2} _{^{*3}}
		Bit	SF-BIT-SL 1,2X6,5-70	PHOENIX CONTACT	N/A	3 - 3.5 N·m (26.6 - 31.0 lbf·in) ^{*2} _{^{*3}}
M8		Bit	SF-BIT-HEX 6-50	PHOENIX CONTACT	N/A	8 - 12 N·m (70.8 - 106.2 lbf·in) ^{*2} _{^{*3}}
M10		Bit	SF-BIT-HEX 8-50	PHOENIX CONTACT	N/A	12 - 14 N·m (106.2 - 123.9 lbf·in) ^{*2} _{^{*3}}

*1 When wiring drive models 2056, 4089, and smaller, select the correct tools for the wire gauge.

*2 Use 6.35 mm (0.25 in) bit socket holder.

*3 Use a torque wrench that can apply this torque measurement range.

■ Main Circuit Wire Gauges and Tightening Torques

Refer to [Three-Phase 200 V Class on page 263](#) and [Three-Phase 400 V Class on page 267](#) for the recommended wire gauges and tightening torques of the main circuit terminals.

Comply with local standards for correct wire gauges in the region where you will use the drive.

WARNING! Electrical Shock Hazard. Only connect peripheral options, for example a DC reactor or braking resistor, to terminals +1, +2, +3, -, B1, and B2. Incorrect wiring can cause serious injury or death.

Note:

- The recommended wire gauges are based on drive continuous current ratings with 75 °C (167 °F) 600 V class 2 heat-resistant indoor PVC wire. Assume these conditions:
 - Ambient temperature: 40 °C (104 °F) maximum
 - Wiring distance: 100 m (3281 ft) maximum
 - Normal Duty rated current value
- Refer to the instruction manual for each device for recommended wire gauges to connect peripheral devices or options to terminals +1, +2, +3, -, B1, and B2. Contact Yaskawa or your nearest sales representative if the recommended wire gauges for the peripheral devices or options are out of the range of the applicable gauges for the drive.
- For drive models 2257 to 2415 and 4208 to 4H12, use UL-approved closed-loop crimp terminals on the drive main circuit terminals. Use the tools recommend by the terminal manufacturer and make sure that the terminals are correctly connected.
- The metric wire gauge values are provided as reference information from equivalent AWG sizes and not exactly the same sizes as the AWG/kcmil values. Obey local safety regulations for wire sizes and make sure that the ferrule or crimp terminals are correct for your size.

Three-Phase 200 V Class

























Model	Terminal	Recomm. Gauge AWG, kcmil	Applicable Gauge AWG, kcmil (mm ²)	IP20 Applicable Gauge *1) AWG, kcmil (mm ²)	Wire Stripping Length *2 mm	Terminal Screw Size and Shape	Tightening Torque N-m (lbf-in)
2004	R/L1, S/L2, T/L3	14	14 - 6 (2.5 - 16)	14 - 6 (2.5 - 16)	10	M4 ⊖	1.5 - 1.7 (13.5 - 15)
	U/T1, V/T2, W/T3	14	14 - 6 (2.5 - 16)	14 - 6 (2.5 - 16)	10	M4 ⊖	1.5 - 1.7 (13.5 - 15)
	-, +1, +2	14	14 - 3 (2.5 - 25)	14 - 3 (2.5 - 25)	18	M5 ⊖	2.3 - 2.5 (19.8 - 22) *3
	B1, B2	14	14 - 10 (2.5 - 6.0)	14 - 10 (2.5 - 6.0)	10	M4 ⊖	1.5 - 1.7 (13.5 - 15)
	⊕	10	14 - 8 (2.5 - 10)	-	-	M4 ⊕	1.2 - 1.5 (10.6 - 13.3)
2006	R/L1, S/L2, T/L3	14	14 - 6 (2.5 - 16)	14 - 6 (2.5 - 16)	10	M4 ⊖	1.5 - 1.7 (13.5 - 15)
	U/T1, V/T2, W/T3	14	14 - 6 (2.5 - 16)	14 - 6 (2.5 - 16)	10	M4 ⊖	1.5 - 1.7 (13.5 - 15)
	-, +1, +2	14	14 - 3 (2.5 - 25)	14 - 3 (2.5 - 25)	18	M5 ⊖	2.3 - 2.5 (19.8 - 22) *3
	B1, B2	14	14 - 10 (2.5 - 6.0)	14 - 10 (2.5 - 6.0)	10	M4 ⊖	1.5 - 1.7 (13.5 - 15)
	⊕	10	14 - 8 (2.5 - 10)	-	-	M4 ⊕	1.2 - 1.5 (10.6 - 13.3)
2010	R/L1, S/L2, T/L3	12	14 - 6 (2.5 - 16)	14 - 6 (2.5 - 16)	10	M4 ⊖	1.5 - 1.7 (13.5 - 15)
	U/T1, V/T2, W/T3	14	14 - 6 (2.5 - 16)	14 - 6 (2.5 - 16)	10	M4 ⊖	1.5 - 1.7 (13.5 - 15)
	-, +1, +2	12	14 - 3 (2.5 - 25)	14 - 3 (2.5 - 25)	18	M5 ⊖	2.3 - 2.5 (19.8 - 22) *3
	B1, B2	14	14 - 10 (2.5 - 6.0)	14 - 10 (2.5 - 6.0)	10	M4 ⊖	1.5 - 1.7 (13.5 - 15)
	⊕	10	14 - 8 (2.5 - 10)	-	-	M4 ⊕	1.2 - 1.5 (10.6 - 13.3)
2012	R/L1, S/L2, T/L3	10	14 - 6 (2.5 - 16)	14 - 6 (2.5 - 16)	10	M4 ⊖	1.5 - 1.7 (13.5 - 15)
	U/T1, V/T2, W/T3	12	14 - 6 (2.5 - 16)	14 - 6 (2.5 - 16)	10	M4 ⊖	1.5 - 1.7 (13.5 - 15)
	-, +1, +2	10	14 - 3 (2.5 - 25)	14 - 3 (2.5 - 25)	18	M5 ⊖	2.3 - 2.5 (19.8 - 22) *3
	B1, B2	14	14 - 10 (2.5 - 6.0)	14 - 10 (2.5 - 6.0)	10	M4 ⊖	1.5 - 1.7 (13.5 - 15)
	⊕	10	14 - 8 (2.5 - 10)	-	-	M4 ⊕	1.2 - 1.5 (10.6 - 13.3)
2018	R/L1, S/L2, T/L3	10	14 - 6 (2.5 - 16)	14 - 6 (2.5 - 16)	10	M4 ⊖	1.5 - 1.7 (13.5 - 15)
	U/T1, V/T2, W/T3	10	14 - 6 (2.5 - 16)	14 - 6 (2.5 - 16)	10	M4 ⊖	1.5 - 1.7 (13.5 - 15)
	-, +1, +2	8	14 - 3 (2.5 - 25)	14 - 3 (2.5 - 25)	18	M5 ⊖	2.3 - 2.5 (19.8 - 22) *3
	B1, B2	14	14 - 10 (2.5 - 6.0)	14 - 10 (2.5 - 6.0)	10	M4 ⊖	1.5 - 1.7 (13.5 - 15)
	⊕	10	14 - 8 (2.5 - 10)	-	-	M4 ⊕	1.2 - 1.5 (10.6 - 13.3)

5.4 UL Standards

Model	Terminal	Recomm. Gauge AWG, kcmil	Applicable Gauge AWG, kcmil (mm ²)	IP20 Applicable Gauge ^{*1)} AWG, kcmil (mm ²)	Wire Stripping Length ^{*2)} mm	Terminal Screw Size and Shape	Tightening Torque N-m (lbf-in)
2021	R/L1, S/L2, T/L3	8	14 - 6 (2.5 - 16)	14 - 6 (2.5 - 16)	10	M4 ⊖	1.5 - 1.7 (13.5 - 15)
	U/T1, V/T2, W/T3	10	14 - 6 (2.5 - 16)	14 - 6 (2.5 - 16)	10	M4 ⊖	1.5 - 1.7 (13.5 - 15)
	-, +1, +2	8	14 - 3 (2.5 - 25)	14 - 3 (2.5 - 25)	18	M5 ⊖	2.3 - 2.5 (19.8 - 22) ^{*3)}
	B1, B2	14	14 - 10 (2.5 - 6.0)	14 - 10 (2.5 - 6.0)	10	M4 ⊖	1.5 - 1.7 (13.5 - 15)
	⊕	10	12 - 8 (4.0 - 10)	-	-	M4 ⊕	1.2 - 1.5 (10.6 - 13.3)
2030	R/L1, S/L2, T/L3	6	14 - 6 (2.5 - 16)	14 - 6 (2.5 - 16)	10	M4 ⊖	1.5 - 1.7 (13.5 - 15)
	U/T1, V/T2, W/T3	8	14 - 6 (2.5 - 16)	14 - 6 (2.5 - 16)	10	M4 ⊖	1.5 - 1.7 (13.5 - 15)
	-, +1, +2	6	14 - 3 (2.5 - 25)	14 - 3 (2.5 - 25)	18	M5 ⊖	2.3 - 2.5 (19.8 - 22) ^{*3)}
	B1, B2	12	14 - 10 (2.5 - 6.0)	14 - 10 (2.5 - 6.0)	10	M4 ⊖	1.5 - 1.7 (13.5 - 15)
	⊕	8	10 - 8 (6.0 - 10)	-	-	M5 ⊕	2.0 - 2.5 (17.7 - 22.1)
2042	R/L1, S/L2, T/L3	6	14 - 6 (2.5 - 16)	14 - 6 (2.5 - 16)	10	M4 ⊖	1.5 - 1.7 (13.5 - 15)
	U/T1, V/T2, W/T3	6	14 - 6 (2.5 - 16)	14 - 6 (2.5 - 16)	10	M4 ⊖	1.5 - 1.7 (13.5 - 15)
	-, +1, +2	3	14 - 3 (2.5 - 25)	14 - 3 (2.5 - 25)	18	M5 ⊖	2.3 - 2.5 (19.8 - 22) ^{*3)}
	B1, B2	10	14 - 10 (2.5 - 6.0)	14 - 10 (2.5 - 6.0)	10	M4 ⊖	1.5 - 1.7 (13.5 - 15)
	⊕	8	10 - 8 (6.0 - 10)	-	-	M5 ⊕	2.0 - 2.5 (17.7 - 22.1)
2056	R/L1, S/L2, T/L3	3	14 - 3 (2.5 - 25)	8 - 3 (10 - 25)	18	M5 ⊖	2.3 - 2.5 (19.8 - 22) ^{*3)}
	U/T1, V/T2, W/T3	4	14 - 4 (2.5 - 25)	10 - 4 (6.0 - 25)	18	M5 ⊖	2.3 - 2.5 (19.8 - 22) ^{*3)}
	-, +1, +2	1	14 - 1 (2.5 - 50)	8 - 1 (10 - 50)	20	M6 ⊖	5 - 5.5 (45 - 49)
	B1, B2	8	14 - 8 (2.5 - 10)	14 - 8 (2.5 - 10)	10	M4 ⊖	1.5 - 1.7 (13.5 - 15)
	⊕	6	8 - 6 (10 - 16)	-	-	M6 ⊕	5.4 - 6.0 (47.8 - 53.1)
2070	R/L1, S/L2, T/L3	1	14 - 1 (2.5 - 50)	6 - 1 (16 - 50)	20	M6 ⊖	5 - 5.5 (45 - 49)
	U/T1, V/T2, W/T3	3	14 - 3 (2.5 - 25)	6 - 3 (16 - 25)	20	M6 ⊖	5 - 5.5 (45 - 49)
	-, +1, +2	1/0	14 - 1/0 (2.5 - 50)	14 - 1/0 (2.5 - 50)	20	M6 ⊖	5 - 5.5 (45 - 49)
	B1, B2	8	14 - 8 (2.5 - 10)	14 - 8 (2.5 - 10)	10	M4 ⊖	1.5 - 1.7 (13.5 - 15)
	⊕	6	6 - 4 (16 - 25)	-	-	M6 ⊕	5.4 - 6.0 (47.8 - 53.1)

Model	Terminal	Recomm. Gauge AWG, kcmil	Applicable Gauge AWG, kcmil (mm ²)	IP20 Applicable Gauge *1) AWG, kcmil (mm ²)	Wire Stripping Length *2 mm	Terminal Screw Size and Shape	Tightening Torque N-m (lbf-in)
2082	R/L1, S/L2, T/L3	1/0	14 - 1/0 (2.5 - 50)	6 - 1/0 (16 - 50)	20	M6	5 - 5.5 (45 - 49)
	U/T1, V/T2, W/T3	2	14 - 2 (2.5 - 35)	6 - 2 (16 - 35)	20	M6	5 - 5.5 (45 - 49)
	-, +1, +2	2/0	14 - 2/0 (2.5 - 70)	14 - 2/0 (2.5 - 70)	20	M6	5 - 5.5 (45 - 49)
	B1, B2	6	14 - 6 (2.5 - 16)	14 - 6 (2.5 - 16)	10	M4	1.5 - 1.7 (13.5 - 15)
		6	6 - 4 (16 - 25)	-	-	M6	5.4 - 6.0 (47.8 - 53.1)
2110	R/L1, S/L2, T/L3	1/0	6 - 1/0 (16 - 50)	6 - 1/0 (16 - 50)	27	M6	8 - 9 (71 - 80)
	U/T1, V/T2, W/T3	1/0	6 - 1/0 (16 - 50)	6 - 1/0 (16 - 50)	27	M6	8 - 9 (71 - 80)
	-, +1	2/0	2 - 2/0 (35 - 70)	2 - 2/0 (35 - 70)	27	M8	10 - 12 (89 - 107)
	B1, B2	4	14 - 4 (2.5 - 25)	10 - 4 (6.0 - 25)	21	M6	3 - 3.5 (27 - 31)
		6	6 - 4 (16 - 25)	-	-	M6	5.4 - 6.0 (47.8 - 53.1)
2138	R/L1, S/L2, T/L3	2/0	6 - 2/0 (16 - 70)	2 - 2/0 (35 - 70)	27	M6	8 - 9 (71 - 80)
	U/T1, V/T2, W/T3	2/0	6 - 2/0 (16 - 70)	2 - 2/0 (35 - 70)	27	M6	8 - 9 (71 - 80)
	-, +1	4/0	2 - 4/0 (35 - 95)	2 - 4/0 (35 - 95)	27	M8	10 - 12 (89 - 107)
	B1, B2	3	14 - 3 (2.5 - 25)	10 - 3 (6.0 - 25)	21	M6	3 - 3.5 (27 - 31)
		4	4 (25)	-	-	M6	5.4 - 6.0 (47.8 - 53.1)
2169	R/L1, S/L2, T/L3	4/0	2 - 250 (35 - 120)	2/0 - 250 (70 - 120)	37	M10	12 - 14 (107 - 124)
	U/T1, V/T2, W/T3	4/0	2 - 300 (35 - 150)	3/0 - 300 (95 - 150)	37	M10	12 - 14 (107 - 124)
	-, -, +1, +1 *4 *5	1	6 - 2/0 (16 - 70)	1/0 - 2/0 (50 - 70)	28	M6	8 - 9 (71 - 80)
	+3 *5	1/0	4 - 2/0 (25 - 70)	1 - 2/0 (50 - 70)	28	M8	8 - 9 (71 - 80)
		4	4 - 1/0 (25 - 50)	-	-	M8	9.0 - 11 (79.7 - 97.4)
2211	R/L1, S/L2, T/L3	250	2 - 250 (35 - 120)	2/0 - 250 (70 - 120)	37	M10	12 - 14 (107 - 124)
	U/T1, V/T2, W/T3	300	2 - 300 (35 - 150)	3/0 - 300 (95 - 150)	37	M10	12 - 14 (107 - 124)
	-, -, +1, +1 *4 *5	2/0	6 - 2/0 (16 - 70)	1/0 - 2/0 (50 - 70)	28	M6	8 - 9 (71 - 80)
	+3 *5	2/0	4 - 2/0 (25 - 70)	1 - 2/0 (35 - 70)	28	M8	8 - 9 (71 - 80)
		4	4 - 1/0 (25 - 50)	-	-	M8	9.0 - 11 (79.7 - 97.4)

5.4 UL Standards

Model	Terminal	Recomm. Gauge AWG, kcmil	Applicable Gauge AWG, kcmil (mm ²)	IP20 Applicable Gauge *1) AWG, kcmil (mm ²)	Wire Stripping Length *2 mm	Terminal Screw Size and Shape	Tightening Torque N·m (lbf·in)
2257	R/L1, S/L2, T/L3	2/0 × 2P	3 - 4/0 × 2P (25 - 95 × 2P)	2/0 - 4/0 × 2P (70 - 95 × 2P)	-	M10 	20 (177)
	U/T1, V/T2, W/T3	2/0 × 2P	3 - 4/0 × 2P (25 - 95 × 2P)	2/0 - 4/0 × 2P (70 - 95 × 2P)	-	M10 	20 (177)
	-, +1	4/0 × 2P	2 - 250 × 2P (35 - 120 × 2P)	4/0 - 250 × 2P (95 × 2P)	-	M10 	20 (177)
	+3	1/0 × 2P	4 - 1/0 × 2P (25 - 50 × 2P)	1/0 × 2P (50 × 2P)	-	M10 	20 (177)
		3	3 - 350 (25 - 185)	-	-	M10 	18 - 23 (159 - 204)
2313	R/L1, S/L2, T/L3	4/0 × 2P	3 - 4/0 × 2P (25 - 95 × 2P)	2/0 - 4/0 × 2P (70 - 95 × 2P)	-	M10 	20 (177)
	U/T1, V/T2, W/T3	3/0 × 2P	3 - 4/0 × 2P (25 - 95 × 2P)	2/0 - 4/0 × 2P (70 - 95 × 2P)	-	M10 	20 (177)
	-, +1	250 × 2P	2 - 250 × 2P (35 - 120 × 2P)	4/0 - 250 × 2P (95 × 2P)	-	M10 	20 (177)
	+3	1/0 × 2P	4 - 1/0 × 2P (25 - 50 × 2P)	1/0 × 2P (50 × 2P)	-	M10 	20 (177)
		2	2 - 350 (35 - 150)	-	-	M10 	18 - 23 (159 - 204)
2360	R/L1, S/L2, T/L3	250 × 2P	2/0 - 300 × 2P (70 - 150 × 2P)	250 - 300 × 2P (120 - 150 × 2P)	-	M12 	35 (310)
	U/T1, V/T2, W/T3	250 × 2P	2/0 - 300 × 2P (70 - 150 × 2P)	250 - 300 × 2P (120 - 150 × 2P)	-	M12 	35 (310)
	-, +1	350 × 2P	4/0 - 400 × 2P (95 - 185 × 2P)	300 - 400 × 2P (150 - 185 × 2P)	-	M12 	35 (310)
	+3	3/0 × 2P	1/0 - 4/0 × 2P (50 - 95 × 2P)	-	-	M12 	35 (310)
		1	1 - 350 (50 - 150)	-	-	M12 	32 - 40 (283 - 354)
2415	R/L1, S/L2, T/L3	250 × 2P	2/0 - 300 × 2P (70 - 150 × 2P)	250 - 300 × 2P (120 - 150 × 2P)	-	M12 	35 (310)
	U/T1, V/T2, W/T3	300 × 2P	2/0 - 300 × 2P (70 - 150 × 2P)	250 - 300 × 2P (120 - 150 × 2P)	-	M12 	35 (310)
	-, +1	350 × 2P	4/0 - 400 × 2P (95 - 185 × 2P)	300 - 400 × 2P (150 - 185 × 2P)	-	M12 	35 (310)
	+3	3/0 × 2P	1/0 - 4/0 × 2P (50 - 95 × 2P)	-	-	M12 	35 (310)
		1	1 - 350 (50 - 150)	-	-	M12 	32 - 40 (283 - 354)

*1 For IP20 protection, use wires that are in the range of applicable gauges.

*2 Remove insulation from the ends of wires to expose the length of wire shown.

*3 When you use AWG 8 or larger wires to comply with UL standards, tighten the screws to a tightening torque of 4.1 N·m to 4.5 N·m (36 lbf·in to 40 lbf·in).

*4 Terminals - and +1 have two screws. The Recommended Gauge is the wire gauge for one terminal.

*5 A junction terminal is necessary to connect a braking unit (CDBR-series) to terminals - and +3.

Three-Phase 400 V Class































Model	Terminal	Recomm. Gauge AWG, kcmil	Applicable Gauge AWG, kcmil (mm ²)	IP20 Applicable Gauge *1) AWG, kcmil (mm ²)	Wire Stripping Length *2 mm	Terminal Screw Size and Shape	Tightening Torque N-m (lbf-in)
4002	R/L1, S/L2, T/L3	14	14 - 6 (2.5 - 16)	14 - 6 (2.5 - 16)	10	M4 ⊖	1.5 - 1.7 (13.5 - 15)
	U/T1, V/T2, W/T3	14	14 - 6 (2.5 - 16)	14 - 6 (2.5 - 16)	10	M4 ⊖	1.5 - 1.7 (13.5 - 15)
	-, +1, +2	14	14 - 3 (2.5 - 25)	14 - 3 (2.5 - 25)	18	M5 ⊖	2.3 - 2.5 (19.8 - 22) *3
	B1, B2	14	14 - 10 (2.5 - 6.0)	14 - 10 (2.5 - 6.0)	10	M4 ⊖	1.5 - 1.7 (13.5 - 15)
	⊕	12	14 - 8 (2.5 - 10)	-	-	M4 ⊕	1.2 - 1.5 (10.6 - 13.3)
4004	R/L1, S/L2, T/L3	14	14 - 6 (2.5 - 16)	14 - 6 (2.5 - 16)	10	M4 ⊖	1.5 - 1.7 (13.5 - 15)
	U/T1, V/T2, W/T3	14	14 - 6 (2.5 - 16)	14 - 6 (2.5 - 16)	10	M4 ⊖	1.5 - 1.7 (13.5 - 15)
	-, +1, +2	14	14 - 3 (2.5 - 25)	14 - 3 (2.5 - 25)	18	M5 ⊖	2.3 - 2.5 (19.8 - 22) *3
	B1, B2	14	14 - 10 (2.5 - 6.0)	14 - 10 (2.5 - 6.0)	10	M4 ⊖	1.5 - 1.7 (13.5 - 15)
	⊕	12	14 - 8 (2.5 - 10)	-	-	M4 ⊕	1.2 - 1.5 (10.6 - 13.3)
4005	R/L1, S/L2, T/L3	14	14 - 6 (2.5 - 16)	14 - 6 (2.5 - 16)	10	M4 ⊖	1.5 - 1.7 (13.5 - 15)
	U/T1, V/T2, W/T3	14	14 - 6 (2.5 - 16)	14 - 6 (2.5 - 16)	10	M4 ⊖	1.5 - 1.7 (13.5 - 15)
	-, +1, +2	14	14 - 3 (2.5 - 25)	14 - 3 (2.5 - 25)	18	M5 ⊖	2.3 - 2.5 (19.8 - 22) *3
	B1, B2	14	14 - 10 (2.5 - 6.0)	14 - 10 (2.5 - 6.0)	10	M4 ⊖	1.5 - 1.7 (13.5 - 15)
	⊕	10	14 - 8 (2.5 - 10)	-	-	M4 ⊕	1.2 - 1.5 (10.6 - 13.3)
4007	R/L1, S/L2, T/L3	14	14 - 6 (2.5 - 16)	14 - 6 (2.5 - 16)	10	M4 ⊖	1.5 - 1.7 (13.5 - 15)
	U/T1, V/T2, W/T3	14	14 - 6 (2.5 - 16)	14 - 6 (2.5 - 16)	10	M4 ⊖	1.5 - 1.7 (13.5 - 15)
	-, +1, +2	14	14 - 3 (2.5 - 25)	14 - 3 (2.5 - 25)	18	M5 ⊖	2.3 - 2.5 (19.8 - 22) *3
	B1, B2	14	14 - 10 (2.5 - 6.0)	14 - 10 (2.5 - 6.0)	10	M4 ⊖	1.5 - 1.7 (13.5 - 15)
	⊕	10	14 - 8 (2.5 - 10)	-	-	M4 ⊕	1.2 - 1.5 (10.6 - 13.3)
4009	R/L1, S/L2, T/L3	14	14 - 6 (2.5 - 16)	14 - 6 (2.5 - 16)	10	M4 ⊖	1.5 - 1.7 (13.5 - 15)
	U/T1, V/T2, W/T3	14	14 - 6 (2.5 - 16)	14 - 6 (2.5 - 16)	10	M4 ⊖	1.5 - 1.7 (13.5 - 15)
	-, +1, +2	12	14 - 3 (2.5 - 25)	14 - 3 (2.5 - 25)	18	M5 ⊖	2.3 - 2.5 (19.8 - 22) *3
	B1, B2	14	14 - 10 (2.5 - 6.0)	14 - 10 (2.5 - 6.0)	10	M4 ⊖	1.5 - 1.7 (13.5 - 15)
	⊕	10	14 - 8 (2.5 - 10)	-	-	M4 ⊕	1.2 - 1.5 (10.6 - 13.3)































5.4 UL Standards

Model	Terminal	Recomm. Gauge AWG, kcmil	Applicable Gauge AWG, kcmil (mm ²)	IP20 Applicable Gauge *1) AWG, kcmil (mm ²)	Wire Stripping Length *2 mm	Terminal Screw Size and Shape	Tightening Torque N-m (lbf-in)
4012	R/L1, S/L2, T/L3	12	14 - 6 (2.5 - 16)	14 - 6 (2.5 - 16)	10	M4 ⊖	1.5 - 1.7 (13.5 - 15)
	U/T1, V/T2, W/T3	14	14 - 6 (2.5 - 16)	14 - 6 (2.5 - 16)	10	M4 ⊖	1.5 - 1.7 (13.5 - 15)
	-, +1, +2	10	14 - 3 (2.5 - 25)	14 - 3 (2.5 - 25)	18	M5 ⊖	2.3 - 2.5 (19.8 - 22) *3
	B1, B2	14	14 - 10 (2.5 - 6.0)	14 - 10 (2.5 - 6.0)	10	M4 ⊖	1.5 - 1.7 (13.5 - 15)
	⊕	10	14 - 8 (2.5 - 10)	-	-	M4 ⊕	1.2 - 1.5 (10.6 - 13.3)
4018	R/L1, S/L2, T/L3	10	14 - 6 (2.5 - 16)	14 - 6 (2.5 - 16)	10	M4 ⊖	1.5 - 1.7 (13.5 - 15)
	U/T1, V/T2, W/T3	10	14 - 6 (2.5 - 16)	14 - 6 (2.5 - 16)	10	M4 ⊖	1.5 - 1.7 (13.5 - 15)
	-, +1, +2	8	14 - 3 (2.5 - 25)	14 - 3 (2.5 - 25)	18	M5 ⊖	2.3 - 2.5 (19.8 - 22) *3
	B1, B2	14	14 - 10 (2.5 - 6.0)	14 - 10 (2.5 - 6.0)	10	M4 ⊖	1.5 - 1.7 (13.5 - 15)
	⊕	10	14 - 8 (2.5 - 10)	-	-	M5 ⊕	2.0 - 2.5 (17.7 - 22.1)
4023	R/L1, S/L2, T/L3	8	14 - 6 (2.5 - 16)	14 - 6 (2.5 - 16)	10	M4 ⊖	1.5 - 1.7 (13.5 - 15)
	U/T1, V/T2, W/T3	10	14 - 6 (2.5 - 16)	14 - 6 (2.5 - 16)	10	M4 ⊖	1.5 - 1.7 (13.5 - 15)
	-, +1, +2	8	14 - 3 (2.5 - 25)	14 - 3 (2.5 - 25)	18	M5 ⊖	2.3 - 2.5 (19.8 - 22) *3
	B1, B2	12	14 - 10 (2.5 - 6.0)	14 - 10 (2.5 - 6.0)	10	M4 ⊖	1.5 - 1.7 (13.5 - 15)
	⊕	10	12 - 8 (4.0 - 10)	-	-	M5 ⊕	2.0 - 2.5 (17.7 - 22.1)
4031	R/L1, S/L2, T/L3	6	14 - 3 (2.5 - 25)	8 - 3 (10 - 25)	18	M5 ⊖	2.3 - 2.5 (19.8 - 22) *3
	U/T1, V/T2, W/T3	8	14 - 4 (2.5 - 25)	10 - 4 (6.0 - 25)	18	M5 ⊖	2.3 - 2.5 (19.8 - 22) *3
	-, +1, +2	6	14 - 1 (2.5 - 50)	8 - 1 (10 - 50)	20	M6 ⊕	5 - 5.5 (45 - 49)
	B1, B2	10	14 - 8 (2.5 - 10)	14 - 8 (2.5 - 10)	10	M4 ⊖	1.5 - 1.7 (13.5 - 15)
	⊕	8	10 - 6 (6.0 - 16)	-	-	M6 ⊕	5.4 - 6.0 (47.8 - 53.1)
4038	R/L1, S/L2, T/L3	6	14 - 3 (2.5 - 25)	8 - 3 (10 - 25)	18	M5 ⊖	2.3 - 2.5 (19.8 - 22) *3
	U/T1, V/T2, W/T3	8	14 - 4 (2.5 - 25)	10 - 4 (6.0 - 25)	18	M5 ⊖	2.3 - 2.5 (19.8 - 22) *3
	-, +1, +2	4	14 - 1 (2.5 - 50)	8 - 1 (10 - 50)	20	M6 ⊕	5 - 5.5 (45 - 49)
	B1, B2	10	14 - 8 (2.5 - 10)	14 - 8 (2.5 - 10)	10	M4 ⊖	1.5 - 1.7 (13.5 - 15)
	⊕	6	10 - 6 (6.0 - 16)	-	-	M6 ⊕	5.4 - 6.0 (47.8 - 53.1)

























Model	Terminal	Recomm. Gauge AWG, kcmil	Applicable Gauge AWG, kcmil (mm ²)	IP20 Applicable Gauge *1) AWG, kcmil (mm ²)	Wire Stripping Length *2 mm	Terminal Screw Size and Shape	Tightening Torque N-m (lbf-in)
4044	R/L1, S/L2, T/L3	4	14 - 4 (2.5 - 25)	10 - 4 (6.0 - 25)	18	M5	2.3 - 2.5 (19.8 - 22) *3
	U/T1, V/T2, W/T3	6	14 - 6 (2.5 - 16)	10 - 6 (6.0 - 16)	18	M5	2.3 - 2.5 (19.8 - 22) *3
	-, +1, +2	3	14 - 3 (2.5 - 25)	10 - 3 (6.0 - 25)	18	M5	2.3 - 2.5 (19.8 - 22) *3
	B1, B2	8	14 - 8 (2.5 - 10)	14 - 8 (2.5 - 10)	10	M4	1.5 - 1.7 (13.5 - 15)
		6	8 - 4 (10 - 25)	-	-	M6	5.4 - 6.0 (47.8 - 53.1)
4060	R/L1, S/L2, T/L3	4	14 - 4 (2.5 - 25)	10 - 4 (6.0 - 25)	18	M5	2.3 - 2.5 (19.8 - 22) *3
	U/T1, V/T2, W/T3	4	14 - 4 (2.5 - 25)	10 - 4 (6.0 - 25)	18	M5	2.3 - 2.5 (19.8 - 22) *3
	-, +1	3	14 - 3 (2.5 - 25)	10 - 3 (6.0 - 25)	18	M5	2.3 - 2.5 (19.8 - 22) *3
	B1, B2	8	14 - 8 (2.5 - 10)	14 - 8 (2.5 - 10)	10	M4	1.5 - 1.7 (13.5 - 15)
		6	8 - 4 (10 - 25)	-	-	M6	5.4 - 6.0 (47.8 - 53.1)
4075	R/L1, S/L2, T/L3	3	14 - 3 (2.5 - 25)	12 - 3 (4.0 - 25)	18	M5	2.3 - 2.5 (19.8 - 22) *3
	U/T1, V/T2, W/T3	3	14 - 3 (2.5 - 25)	12 - 3 (4.0 - 25)	18	M5	2.3 - 2.5 (19.8 - 22) *3
	-, +1	2	14 - 2 (2.5 - 35)	10 - 2 (6.0 - 35)	18	M5	2.3 - 2.5 (19.8 - 22) *3
	B1, B2	6	14 - 6 (2.5 - 16)	14 - 6 (2.5 - 16)	10	M4	1.5 - 1.7 (13.5 - 15)
		6	6 - 4 (16 - 25)	-	-	M6	5.4 - 6.0 (47.8 - 53.1)
4089	R/L1, S/L2, T/L3	2	14 - 2 (2.5 - 35)	10 - 2 (6.0 - 35)	18	M5	2.3 - 2.5 (19.8 - 22) *3
	U/T1, V/T2, W/T3	2	14 - 2 (2.5 - 35)	10 - 2 (6.0 - 35)	18	M5	2.3 - 2.5 (19.8 - 22) *3
	-, +1	1/0	14 - 1/0 (2.5 - 50)	6 - 1/0 (16 - 50)	20	M6	5 - 5.5 (45 - 49)
	B1, B2	6	14 - 6 (2.5 - 16)	14 - 6 (2.5 - 16)	18	M5	2.3 - 2.5 (19.8 - 22) *3
		4	6 - 4 (16 - 25)	-	-	M6	5.4 - 6.0 (47.8 - 53.1)
4103	R/L1, S/L2, T/L3	1/0	6 - 2/0 (16 - 70)	2 - 2/0 (35 - 70)	27	M6	8 - 9 (71 - 80)
	U/T1, V/T2, W/T3	1	6 - 2/0 (16 - 70)	2 - 2/0 (35 - 70)	27	M6	8 - 9 (71 - 80)
	-, +1	2/0	2 - 4/0 (35 - 95)	2 - 4/0 (35 - 95)	27	M8	10 - 12 (89 - 107)
	B1, B2	3	14 - 3 (2.5 - 25)	10 - 3 (6.0 - 25)	21	M6	3 - 3.5 (27 - 31)
		4	6 - 4 (16 - 25)	-	-	M6	5.4 - 6.0 (47.8 - 53.1)

5.4 UL Standards

Model	Terminal	Recomm. Gauge AWG, kcmil	Applicable Gauge AWG, kcmil (mm ²)	IP20 Applicable Gauge *1) AWG, kcmil (mm ²)	Wire Stripping Length *2 mm	Terminal Screw Size and Shape	Tightening Torque N-m (lbf-in)
4140	R/L1, S/L2, T/L3	3/0	2 - 250 (35 - 120)	2/0 - 250 (70 - 120)	37	M10 	12 - 14 (107 - 124)
	U/T1, V/T2, W/T3	2/0	2 - 300 (35 - 150)	3/0 - 300 (95 - 150)	37	M10 	12 - 14 (107 - 124)
	-, -, +1, +1 *4	2	6 - 2/0 (16 - 70)	1/0 - 2/0 (50 - 70)	28	M6 	8 - 9 (71 - 80)
	B1, B2 *5	1	4 - 2/0 (25 - 70)	1 - 2/0 (50 - 70)	28	M8 	8 - 9 (71 - 80)
		4	4 - 1/0 (25 - 50)	-	-	M8 	9.0 - 11 (79.7 - 97.4)
4168	R/L1, S/L2, T/L3	4/0	2 - 250 (35 - 120)	2/0 - 250 (70 - 120)	37	M10 	12 - 14 (107 - 124)
	U/T1, V/T2, W/T3	4/0	2 - 300 (35 - 150)	3/0 - 300 (95 - 150)	37	M10 	12 - 14 (107 - 124)
	-, -, +1, +1 *4	1/0	6 - 2/0 (16 - 70)	1/0 - 2/0 (50 - 70)	28	M6 	8 - 9 (71 - 80)
	B1, B2 *5	1/0	4 - 2/0 (25 - 70)	1 - 2/0 (50 - 70)	28	M8 	8 - 9 (71 - 80)
		4	4 - 1/0 (25 - 50)	-	-	M8 	9.0 - 11 (79.7 - 97.4)
4208	R/L1, S/L2, T/L3	1/0 × 2P	3 - 4/0 × 2P (25 - 95 × 2P)	2/0 - 4/0 × 2P (70 - 95 × 2P)	-	M10 	20 (177)
	U/T1, V/T2, W/T3	1/0 × 2P	3 - 4/0 × 2P (25 - 95 × 2P)	2/0 - 4/0 × 2P (70 - 95 × 2P)	-	M10 	20 (177)
	-, +1	3/0 × 2P	2 - 250 × 2P (35 - 120 × 2P)	4/0 - 250 × 2P (95 × 2P)	-	M10 	20 (177)
	+3	1/0 × 2P	4 - 1/0 × 2P (25 - 50 × 2P)	1/0 × 2P (50 × 2P)	-	M10 	20 (177)
		4	4 - 350 (25 - 150)	-	-	M10 	18 - 23 (159 - 204)
4250	R/L1, S/L2, T/L3	2/0 × 2P	3 - 4/0 × 2P (25 - 95 × 2P)	2/0 - 4/0 × 2P (70 - 95 × 2P)	-	M10 	20 (177)
	U/T1, V/T2, W/T3	2/0 × 2P	3 - 4/0 × 2P (25 - 95 × 2P)	2/0 - 4/0 × 2P (70 - 95 × 2P)	-	M10 	20 (177)
	-, +1	3/0 × 2P	2 - 250 × 2P (35 - 120 × 2P)	4/0 - 250 × 2P (95 × 2P)	-	M10 	20 (177)
	+3	1/0 × 2P	4 - 1/0 × 2P (25 - 50 × 2P)	1/0 × 2P (50 × 2P)	-	M10 	20 (177)
		2	2 - 350 (35 - 150)	-	-	M10 	18 - 23 (159 - 204)
4296	R/L1, S/L2, T/L3	3/0 × 2P	3 - 4/0 × 2P (25 - 95 × 2P)	2/0 - 4/0 × 2P (70 - 95 × 2P)	-	M10 	20 (177)
	U/T1, V/T2, W/T3	3/0 × 2P	3 - 4/0 × 2P (25 - 95 × 2P)	2/0 - 4/0 × 2P (70 - 95 × 2P)	-	M10 	20 (177)
	-, +1	4/0 × 2P	2 - 250 × 2P (35 - 120 × 2P)	4/0 - 250 × 2P (95 × 2P)	-	M10 	20 (177)
	+3	1/0 × 2P	4 - 1/0 × 2P (25 - 50 × 2P)	1/0 × 2P (50 × 2P)	-	M10 	20 (177)
		2	2 - 350 (35 - 185)	-	-	M10 	18 - 23 (159 - 204)

Model	Terminal	Recomm. Gauge AWG, kcmil	Applicable Gauge AWG, kcmil (mm ²)	IP20 Applicable Gauge *1) AWG, kcmil (mm ²)	Wire Stripping Length *2 mm	Terminal Screw Size and Shape	Tightening Torque N·m (lbf·in)
4371	R/L1, S/L2, T/L3	250 × 2P	2/0 - 300 × 2P (70 - 150 × 2P)	250 - 300 × 2P (120 - 150 × 2P)	-	M12 	35 (310)
	U/T1, V/T2, W/T3	250 × 2P	2/0 - 300 × 2P (70 - 150 × 2P)	250 - 300 × 2P (120 - 150 × 2P)	-	M12 	35 (310)
	-, +1	350 × 2P	4/0 - 400 × 2P (95 - 185 × 2P)	300 - 400 × 2P (150 - 185 × 2P)	-	M12 	35 (310)
	+3	3/0 × 2P	1 - 4/0 × 2P (50 - 95 × 2P)	-	-	M12 	35 (310)
		1	1 - 350 (50 - 185)	-	-	M12 	32 - 40 (283 - 354)
4389	R/L1, S/L2, T/L3	300 × 2P	2/0 - 300 × 2P (70 - 150 × 2P)	250 - 300 × 2P (120 - 150 × 2P)	-	M12 	35 (310)
	U/T1, V/T2, W/T3	300 × 2P	2/0 - 300 × 2P (70 - 150 × 2P)	250 - 300 × 2P (120 - 150 × 2P)	-	M12 	35 (310)
	-, +1	400 × 2P	4/0 - 400 × 2P (95 - 185 × 2P)	300 - 400 × 2P (150 - 185 × 2P)	-	M12 	35 (310)
	+3	4/0 × 2P	1 - 4/0 × 2P (50 - 95 × 2P)	-	-	M12 	35 (310)
		1	1 - 350 (35 - 185)	-	-	M12 	32 - 40 (283 - 354)
4453	R/L1, S/L2, T/L3	250 × 4P	2/0 - 300 × 4P (70 - 150 × 4P)	250 - 300 × 4P (120 - 150 × 4P)	-	M12 	35 (310)
	U/T1, V/T2, W/T3	4/0 × 4P	2/0 - 300 × 4P (70 - 150 × 4P)	250 - 300 × 4P (120 - 150 × 4P)	-	M12 	35 (310)
	-, +1	4/0 × 4P	3/0 - 400 × 4P (95 - 185 × 4P)	300 - 400 × 4P (150 - 185 × 4P)	-	M12 	35 (310)
	+3	3/0 × 4P	2 - 4/0 × 4P (35 - 95 × 4P)	4/0 × 4P (95 × 4P)	-	M12 	35 (310)
		1/0	1/0 - 300 (50 - 150)	-	-	M12 	32 - 40 (283 - 354)
4568	R/L1, S/L2, T/L3	250 × 4P	2/0 - 300 × 4P (70 - 150 × 4P)	250 - 300 × 4P (120 - 150 × 4P)	-	M12 	35 (310)
	U/T1, V/T2, W/T3	4/0 × 4P	2/0 - 300 × 4P (70 - 150 × 4P)	250 - 300 × 4P (120 - 150 × 4P)	-	M12 	35 (310)
	-, +1	300 × 4P	3/0 - 400 × 4P (95 - 185 × 4P)	300 - 400 × 4P (150 - 185 × 4P)	-	M12 	35 (310)
	+3	3/0 × 4P	2 - 4/0 × 4P (35 - 95 × 4P)	4/0 × 4P (95 × 4P)	-	M12 	35 (310)
		2/0	2/0 - 300 (70 - 150)	-	-	M12 	32 - 40 (283 - 354)
4675	R/L1, S/L2, T/L3	300 × 4P	2/0 - 300 × 4P (70 - 150 × 4P)	250 - 300 × 4P (120 - 150 × 4P)	-	M12 	35 (310)
	U/T1, V/T2, W/T3	300 × 4P	2/0 - 300 × 4P (70 - 150 × 4P)	250 - 300 × 4P (120 - 150 × 4P)	-	M12 	35 (310)
	-, +1	400 × 4P	3/0 - 400 × 4P (95 - 185 × 4P)	300 - 400 × 4P (150 - 185 × 4P)	-	M12 	35 (310)
	+3	4/0 × 4P	2 - 4/0 × 4P (35 - 95 × 4P)	4/0 × 4P (95 × 4P)	-	M12 	35 (310)
		2/0	2/0 - 300 (70 - 150)	-	-	M12 	32 - 40 (283 - 354)

5.4 UL Standards

Model	Terminal	Recomm. Gauge AWG, kcmil	Applicable Gauge AWG, kcmil (mm ²)	IP20 Applicable Gauge *) AWG, kcmil (mm ²)	Wire Stripping Length *2 mm	Terminal Screw Size and Shape	Tightening Torque N·m (lbf·in)
4810	R/L1, S/L2, T/L3 R1/L11, S1/L21, T1/L31	3/0 × 4P × 2	2/0 - 300 × 4P × 2 (70 - 150)	-	-	M12 	35 (310)
	U/T1, V/T2, W/T3	3/0 × 4P × 2	2/0 - 300 × 4P × 2 (70 - 150)	-	-	M12 	35 (310)
	-, +1	4/0 × 4P × 2	3/0 - 300 × 4P × 2 (95 - 150)	-	-	M12 	35 (310)
	+3	1/0 × 4P × 2	1/0 - 300 × 4P × 2 (50 - 150)	-	-	M12 	35 (310)
		3/0	3/0 - 250 (95 - 120)	-	-	M12 	32 - 40 (283 - 354)
4930	R/L1, S/L2, T/L3 R1/L11, S1/L21, T1/L31	4/0 × 4P × 2	3/0 - 300 × 4P × 2 (95 - 150)	-	-	M12 	35 (310)
	U/T1, V/T2, W/T3	4/0 × 4P × 2	3/0 - 300 × 4P × 2 (95 - 150)	-	-	M12 	35 (310)
	-, +1	4/0 × 4P × 2	3/0 - 300 × 4P × 2 (95 - 150)	-	-	M12 	35 (310)
	+3	1/0 × 4P × 2	1/0 - 300 × 4P × 2 (50 - 150)	-	-	M12 	35 (310)
		3/0	3/0 - 250 (95 - 120)	-	-	M12 	32 - 40 (283 - 354)
4H11	R/L1, S/L2, T/L3 R1/L11, S1/L21, T1/L31	250 × 4P × 2	4/0 - 300 × 4P × 2 (95 - 150)	-	-	M12 	35 (310)
	U/T1, V/T2, W/T3	250 × 4P × 2	4/0 - 300 × 4P × 2 (95 - 150)	-	-	M12 	35 (310)
	-, +1	300 × 4P × 2	250 - 300 × 4P × 2 (120 - 150)	-	-	M12 	35 (310)
	+3	2/0 × 4P × 2	1/0 - 300 × 4P × 2 (50 - 150)	-	-	M12 	35 (310)
		4/0	4/0 - 250 (95 - 120)	-	-	M12 	32 - 40 (283 - 354)
4H12	R/L1, S/L2, T/L3 R1/L11, S1/L21, T1/L31	300 × 4P × 2	4/0 - 300 × 4P × 2 (95 - 150)	-	-	M12 	35 (310)
	U/T1, V/T2, W/T3	300 × 4P × 2	4/0 - 300 × 4P × 2 (95 - 150)	-	-	M12 	35 (310)
	-, +1	300 × 4P × 2	250 - 300 × 4P × 2 (120 - 150)	-	-	M12 	35 (310)
	+3	3/0 × 4P × 2	2/0 - 300 × 4P × 2 (70 - 150)	-	-	M12 	35 (310)
		4/0	4/0 - 250 (95 - 120)	-	-	M12 	32 - 40 (283 - 354)

*1 For IP20 protection, use wires that are in the range of applicable gauges.

























*2 Remove insulation from the ends of wires to expose the length of wire shown.

*3 When you use AWG 8 or larger wires to comply with UL standards, tighten the screws to a tightening torque of 4.1 N·m to 4.5 N·m (36 lbf·in to 40 lbf·in).

*4 Terminals - and +1 have two screws. The Recommended Gauge is the wire gauge for one terminal.

*5 A junction terminal is necessary to connect a braking resistor unit (LKEB-series) to terminals B1 and B2.

6-Phase/12-Pulse 400 V Class

Model	Terminal	Recomm. Gauge ^{*1} AWG, kcmil	Applicable Gauge AWG, kcmil (mm ²)	Terminal Screw Size and Shape	Tightening Torque N·m (lbf·in)
4810	R/L1, S/L2, T/L3 R1/L11, S1/L21, T1/L31 ^{*2}	2/0 × 4P (×2)	2/0 - 300 (70 - 150)	M12 	35 (310)
	U/T1, V/T2, W/T3	3/0 × 4P × 2	2/0 - 300 (70 - 150)	M12 	35 (310)
	-, +1	4/0 × 4P × 2	3/0 - 300 (95 - 150)	M12 	35 (310)
	+3	1/0 × 4P × 2	1/0 - 300 (50 - 150)	M12 	35 (310)
		3/0	3/0 - 250 (95 - 120)	M12 	32 - 40 (283 - 354)
4930	R/L1, S/L2, T/L3 R1/L11, S1/L21, T1/L31 ^{*2}	3/0 × 4P (×2)	2/0 - 300 (95 - 150)	M12 	35 (310)
	U/T1, V/T2, W/T3	4/0 × 4P × 2	3/0 - 300 (95 - 150)	M12 	35 (310)
	-, +1	4/0 × 4P × 2	3/0 - 300 (95 - 150)	M12 	35 (310)
	+3	1/0 × 4P × 2	1/0 - 300 (50 - 150)	M12 	35 (310)
		3/0	3/0 - 250 (95 - 120)	M12 	32 - 40 (283 - 354)
4H11	R/L1, S/L2, T/L3 R1/L11, S1/L21, T1/L31 ^{*2}	4/0 × 4P (×2)	3/0 - 300 (95 - 150)	M12 	35 (310)
	U/T1, V/T2, W/T3	250 × 4P × 2	4/0 - 300 (95 - 150)	M12 	35 (310)
	-, +1	300 × 4P × 2	250 - 300 (120 - 150)	M12 	35 (310)
	+3	2/0 × 4P × 2	1/0 - 300 (50 - 150)	M12 	35 (310)
		4/0	4/0 - 250 (95 - 120)	M12 	32 - 40 (283 - 354)
4H12	R/L1, S/L2, T/L3 R1/L11, S1/L21, T1/L31 ^{*2}	4/0 × 4P (×2)	4/0 - 300 (95 - 150)	M12 	35 (310)
	U/T1, V/T2, W/T3	300 × 4P × 2	4/0 - 300 (95 - 150)	M12 	35 (310)
	-, +1	300 × 4P × 2	250 - 300 (120 - 150)	M12 	35 (310)
	+3	3/0 × 4P × 2	2/0 - 300 (70 - 150)	M12 	35 (310)
		4/0	4/0 - 250 (95 - 120)	M12 	32 - 40 (283 - 354)

*1 The wire gauges for drive models 4810 to 4H12 are the recommended wire gauges when you use these drive models as a 6-Phase/12-Pulse drive.

*2 When you use drive models 4810 to 4H12 as a 6-Phase/12-Pulse drive, remove the common bus bars on the input terminals.

■ Closed-Loop Crimp Terminals

To comply with UL standards on drive models 2257 to 2415 and 4208 to 4H12, use UL Listed closed-loop crimp terminals and insulation caps. Use the tools recommend by the terminal manufacturer to crimp the closed-loop crimp terminal. Yaskawa recommends closed-loop crimp terminals from JST Mfg. Co., Ltd. and insulation caps from Tokyo DIP Co., Ltd.

Make sure that you comply with local standards for correct wire gauges in the region where you will use the drive. Refer to [Table 5.19](#), [Table 5.20](#), and [Table 5.21](#) to select crimp terminals as specified by drive model and wire gauge.

Note:

To comply with UL standards, use only insulated crimp terminals or crimp terminals with insulation tubing. Use UL Listed vinyl-coated insulated copper wires for operation with a continuous maximum permitted temperature of 75 °C at 600 V.

Table 5.19 Closed-Loop Crimp Terminals and Insulation Caps: Three-Phase 200 V Class

Model	Recomm. Gauge (AWG, kcmil)					Terminal Screw Size	Crimp Terminal Model	Crimping Tool		Insulation Cap Model
	R/L1 S/L2 T/L3	U/T1 V/T2 W/T3	-, +1	+3	⊕			Tool Model	Die Jaw	
2004 - 2021	-	-	-	-	10	M4	R5.5-4	YA-4	AD-900	TP-005
2030, 2042	-	-	-	-	8	M5	R8-5	YA-4	AD-901	TP-008
2056	-	-	-	-	6	M6	R14-6	YA-4	AD-902	TP-014
2070 - 2110	-	-	-	-	6	M6	R14-6	YA-4	AD-902	TP-014
2138	-	-	-	-	4	M6	R22-6	YA-5	AD-953	TP-022
2169, 2211	-	-	-	-	4	M8	R22-8	YA-5	AD-953	TP-022
2257	2/0 × 2P	2/0 × 2P	-	-	-	M10	80-10	YF-1 YET-150-1	TD-227, TD-214	TP-080
	-	-	4/0 × 2P	-	-	M10	R100-10	YF-1 YET-150-1	TD-228, TD-214	TP-100
	-	-	-	1/0 × 2P	-	M10	R60-10	YF-1 YET-150-1	TD-225, TD-213	TP-060
	-	-	-	-	3	M10	R38-10	YF-1 YET-150-1	TD-224, TD-212	TP-038
2313	4/0 × 2P	-	-	-	-	M10	R100-10	YF-1 YET-150-1	TD-228, TD-214	TP-100
	-	3/0 × 2P	-	-	-	M10	80-10	YF-1 YET-150-1	TD-227, TD-214	TP-080
	-	-	250 × 2P	-	-	M10	R150-10	YF-1 YET-150-1	TD-229, TD-215	TP-150
	-	-	-	1/0 × 2P	-	M10	R60-10	YF-1 YET-150-1	TD-225, TD-213	TP-060
	-	-	-	-	2	M10	R38-10	YF-1 YET-150-1	TD-224, TD-212	TP-038
2360	250 × 2P	250 × 2P	-	-	-	M12	R150-12	YF-1 YET-300-1	TD-325, TD-313	TP-150
	-	-	350 × 2P	-	-	M12	R200-12	YF-1 YET-300-1	TD-327, TD-314	TP-200
	-	-	-	3/0 × 2P	-	M12	80-12	YF-1 YET-300-1	TD-323, TD-312	TP-080
	-	-	-	-	1	M12	R60-12	YF-1 YET-300-1	TD-321, TD-311	TP-060
2415	250 × 2P	-	-	-	-	M12	R150-12	YF-1 YET-300-1	TD-325, TD-313	TP-150
	-	300 × 2P	-	-	-	M12	R150-12	YF-1 YET-300-1	TD-325, TD-313	TP-150
	-	-	350 × 2P	-	-	M12	R200-12	YF-1 YET-300-1	TD-327, TD-314	TP-200
	-	-	-	3/0 × 2P	-	M12	80-12	YF-1 YET-300-1	TD-323, TD-312	TP-080
	-	-	-	-	1	M12	R60-12	YF-1 YET-300-1	TD-321, TD-311	TP-060

Table 5.20 Closed-Loop Crimp Terminals and Insulation Caps: Three-Phase 400 V Class

Model	Recomm. Gauge (AWG, kcmil)					Terminal Screw Size	Crimp Terminal Model	Crimping Tool		Insulation Cap Model
	R/L1 S/L2 T/L3	U/T1 V/T2 W/T3	-, +1	+3	⊕			Tool Model	Die Jaw	
4002, 4004	-	-	-	-	12	M4	R5.5-4	YA-4	AD-900	TP-005
4005 - 4012	-	-	-	-	10	M4	R5.5-4	YA-4	AD-900	TP-005
4018, 4023	-	-	-	-	10	M5	R5.5-5	YA-4	AD-900	TP-005
4031	-	-	-	-	8	M6	R8-6	YA-4	AD-901	TP-008

Model	Recomm. Gauge (AWG, kcmil)					Terminal Screw Size	Crimp Terminal Model	Crimping Tool		Insulation Cap Model
	R/L1 S/L2 T/L3	U/T1 V/T2 W/T3	- , +1	+3	⊕			Tool Model	Die Jaw	
4038	-	-	-	-	6	M6	R14-6	YA-4	AD-902	TP-014
4044, 4060	-	-	-	-	6	M6	R14-6	YA-4	AD-902	TP-014
4075	-	-	-	-	6	M6	R14-6	YA-4	AD-902	TP-014
4089, 4103	-	-	-	-	4	M6	R22-6	YA-5	AD-953	TP-022
4140, 4168	-	-	-	-	4	M8	R22-8	YA-5	AD-953	TP-022
4208	1/0 × 2P	1/0 × 2P	-	1/0 × 2P	-	M10	R60-10	YF-1 YET-150-1	TD-225, D-213	TP-060
	-	-	3/0 × 2P	-	-	M10	80-10	YF-1 YET-150-1	TD-227, TD-214	TP-080
	-	-	-	-	4	M10	R22-10	YF-1 YET-150-1	TD-223, TD-212	TP-022
4250	2/0 × 2P	2/0 × 2P	-	-	-	M10	80-10	YF-1 YET-150-1	TD-227, TD-214	TP-080
	-	-	3/0 × 2P	-	-	M10	80-10	YF-1 YET-150-1	TD-227, TD-214	TP-080
	-	-	-	1/0 × 2P	-	M10	R60-10	YF-1 YET-150-1	TD-225, TD-213	TP-060
	-	-	-	-	2	M10	R38-10	YF-1 YET-150-1	TD-224, TD-212	TP-038
4296	3/0 × 2P	3/0 × 2P	-	-	-	M10	80-10	YF-1 YET-150-1	TD-227, TD-214	TP-080
	-	-	4/0 × 2P	-	-	M10	R100-10	YF-1 YET-150-1	TD-228, TD-214	TP-100
	-	-	-	1/0 × 2P	-	M10	R60-10	YF-1 YET-150-1	TD-225, TD-213	TP-060
	-	-	-	-	2	M10	R38-10	YF-1 YET-150-1	TD-224, TD-212	TP-038
4371	250 × 2P	250 × 2P	-	-	-	M12	R150-12	YF-1 YET-300-1	TD-325, TD-313	TP-150
	-	-	350 × 2P	-	-	M12	R200-12	YF-1 YET-300-1	TD-327, TD-314	TP-200
	-	-	-	3/0 × 2P	-	M12	80-12	YF-1 YET-300-1	TD-323, TD-312	TP-080
	-	-	-	-	1	M12	R60-12	YF-1 YET-300-1	TD-321, TD-311	TP-060
4389	300 × 2P	300 × 2P	-	-	-	M12	R150-12	YF-1 YET-300-1	TD-325, TD-313	TP-150
	-	-	400 × 2P	-	-	M12	R200-12	YF-1 YET-300-1	TD-327, TD-314	TP-200
	-	-	-	4/0 × 2P	-	M12	R100-12	YF-1 YET-300-1	TD-324, TD-312	TP-100
	-	-	-	-	1	M12	R60-12	YF-1 YET-300-1	TD-321, TD-311	TP-060
4453	250 × 4P	-	-	-	-	M12	R150-12	YF-1 YET-300-1	TD-325, TD-313	TP-150
	-	4/0 × 4P	4/0 × 4P	-	-	M12	R100-12	YF-1 YET-300-1	TD-324, TD-312	TP-100
	-	-	-	3/0 × 4P	-	M12	80-12	YF-1 YET-300-1	TD-323, TD-312	TP-080
	-	-	-	-	1/0	M12	R60-12	YF-1 YET-300-1	TD-321, TD-311	TP-060

5.4 UL Standards

Model	Recomm. Gauge (AWG, kcmil)					Terminal Screw Size	Crimp Terminal Model	Crimping Tool		Insulation Cap Model
	R/L1 S/L2 T/L3	U/T1 V/T2 W/T3	-, +1	+3	⊕			Tool Model	Die Jaw	
4568	250 × 4P	-	-	-	-	M12	R150-12	YF-1 YET-300-1	TD-325, TD-313	TP-150
	-	4/0 × 4P	-	-	-	M12	R100-12	YF-1 YET-300-1	TD-324, TD-312	TP-100
	-	-	300 × 4P	-	-	M12	R150-12	YF-1 YET-300-1	TD-325, TD-313	TP-150
	-	-	-	3/0 × 4P	-	M12	80-12	YF-1 YET-300-1	TD-323, TD-312	TP-080
	-	-	-	-	2/0	M12	80-12	YF-1 YET-300-1	TD-323, TD-312	TP-080
4675	300 × 4P	300 × 4P	-	-	-	M12	R150-12	YF-1 YET-300-1	TD-325, TD-313	TP-150
	-	-	400 × 4P	-	-	M12	R200-12	YF-1 YET-300-1	TD-327, TD-314	TP-200
	-	-	-	4/0 × 4P	-	M12	R100-12	YF-1 YET-300-1	TD-324, TD-312	TP-100
	-	-	-	-	2/0	M12	80-12	YF-1 YET-300-1	TD-323, TD-312	TP-080
4810	3/0 × 4P × 2	-	-	-	-	M12	80-L12	YF-1 YET-150-1	TD-227, TD-214	TP-080
	-	3/0 × 4P × 2	-	-	3/0	M12	80-12	YF-1 YET-150-1	TD-227, TD-214	TP-080
	-	-	4/0 × 4P × 2	-	-	M12	R100-12	YF-1 YET-150-1	TD-228, TD-214	TP-100
	-	-	-	1/0 × 4P × 2	-	M12	R60-12	YF-1 YET-150-1	TD-225, TD-213	TP-060
4930	4/0 × 4P × 2	-	-	-	-	M12	100-L12	YF-1 YET-150-1	TD-228, TD-214	TP-100
	-	4/0 × 4P × 2	4/0 × 4P × 2	-	-	M12	R100-12	YF-1 YET-150-1	TD-228, TD-214	TP-100
	-	-	-	1/0 × 4P × 2	-	M12	R60-12	YF-1 YET-150-1	TD-225, TD-213	TP-060
	-	-	-	-	3/0	M12	80-12	YF-1 YET-150-1	TD-227, TD-214	TP-080
4H11	250 × 4P × 2	-	-	-	-	M12	150-L12	YF-1 YET-150-1	TD-229, TD-215	TP-150
	-	250 × 4P × 2	300 × 4P × 2	-	-	M12	R150-12	YF-1 YET-150-1	TD-229, TD-215	TP-150
	-	-	-	2/0 × 4P × 2	-	M12	70-12	YF-1 YET-150-1	TD-227, TD-214	TP-070
	-	-	-	-	4/0	M12	R100-12	YF-1 YET-150-1	TD-228, TD-214	TP-100
4H12	300 × 4P × 2	-	-	-	-	M12	150-L12	YF-1 YET-150-1	TD-229, TD-215	TP-150
	-	300 × 4P × 2	300 × 4P × 2	-	-	M12	R150-12	YF-1 YET-150-1	TD-229, TD-215	TP-150
	-	-	-	3/0 × 4P × 2	-	M12	80-12	YF-1 YET-150-1	TD-227, TD-214	TP-080
	-	-	-	-	4/0	M12	R100-12	YF-1 YET-150-1	TD-228, TD-214	TP-100

Table 5.21 Closed-Loop Crimp Terminals and Insulation Caps: 6-Phase/12-Pulse 400 V Class (Drive Models: 4xxx)

Model	Recomm. Gauge (AWG, kcmil) *1					Terminal Screw Size	Crimp Terminal Model	Crimping Tool		Insulation Cap Model
	R/L1, R1/L11 S/L2, S1/L21 T/L3, T1/L31 *2	U/T1 V/T2 W/T3	- , +1	+3	⊕			Tool Model	Die Jaw	
4810	2/0 × 4P (× 2)	-	-	-	-	M12	70-12	YF-1 YET-150-1	TD-227, TD-214	TP-070
	-	3/0 × 4P × 2	-	-	-	M12	80-12	YF-1 YET-150-1	TD-227, TD-214	TP-080
	-	-	4/0 × 4P × 2	-	-	M12	R100-12	YF-1 YET-150-1	TD-228, TD-214	TP-100
	-	-	-	1/0 × 4P × 2	-	M12	R60-12	YF-1 YET-150-1	TD-225, TD-213	TP-060
	-	-	-	-	3/0	M12	80-12	YF-1 YET-150-1	TD-227, TD-214	TP-080
4930	3/0 × 4P (× 2)	-	-	-	-	M12	80-12	YF-1 YET-150-1	TD-227, TD-214	TP-080
	-	4/0 × 4P × 2	4/0 × 4P × 2	-	-	M12	R100-12	YF-1 YET-150-1	TD-228, TD-214	TP-100
	-	-	-	1/0 × 4P × 2	-	M12	R60-12	YF-1 YET-150-1	TD-225, TD-213	TP-060
	-	-	-	-	3/0	M12	80-12	YF-1 YET-150-1	TD-227, TD-214	TP-080
4H11	4/0 × 4P (× 2)	-	-	-	-	M12	R100-12	YF-1 YET-150-1	TD-228, TD-214	TP-100
	-	250 × 4P × 2	-	-	-	M12	R150-12	YF-1 YET-150-1	TD-229, TD-215	TP-150
	-	-	300 × 4P × 2	-	-	M12	R150-12	YF-1 YET-150-1	TD-229, TD-215	TP-150
	-	-	-	2/0 × 4P × 2	-	M12	70-12	YF-1 YET-150-1	TD-227, TD-214	TP-070
	-	-	-	-	4/0	M12	R100-12	YF-1 YET-150-1	TD-228, TD-214	TP-100
4H12	4/0 × 4P (× 2)	-	-	-	-	M12	R100-12	YF-1 YET-150-1	TD-228, TD-214	TP-100
	-	300 × 4P × 2	300 × 4P × 2	-	-	M12	R150-12	YF-1 YET-150-1	TD-229, TD-215	TP-150
	-	-	-	3/0 × 4P × 2	-	M12	80-12	YF-1 YET-150-1	TD-227, TD-214	TP-080
	-	-	-	-	4/0	M12	R100-12	YF-1 YET-150-1	TD-228, TD-214	TP-100

*1 The wire gauges for drive models 4810 to 4H12 are the recommended wire gauges when you use these drive models as a 6-Phase/12-Pulse drive.

*2 When you use drive models 4810 to 4H12 as a 6-Phase/12-Pulse drive, remove the common bus bars on the input terminals.

■ Factory-Recommended Branch Circuit Protection for UL Listing

Use branch circuit protection to protect against short circuits and to maintain compliance with UL 61800-5-1. Yaskawa recommends connecting semiconductor protection fuses on the input side for branch circuit protection. Refer to [Three-Phase 200 V Class on page 278](#) and [Three-Phase 400 V Class on page 279](#) for more information about recommended fuses.

WARNING! Electrical Shock Hazard. After the drive blows a fuse or trips an RCM/RCD, do not immediately energize the drive or operate peripheral devices. Wait for the time specified on the warning label at a minimum and make sure that all indicators are OFF. Then check the wiring and peripheral device ratings to find the cause of the problem. If you do not know the cause of the problem, contact Yaskawa before you energize the drive or peripheral devices. If you do not fix the problem before you operate the drive or peripheral devices, it can cause serious injury or death.

- 200 V Class

Use the fuses specified in this document to prepare the drive for use on a circuit that supplies not more than 100,000 RMS and not more than 240 Vac when there is a short circuit in the power supply.

- 400 V Class

5.4 UL Standards

Use the fuses specified in this document to prepare the drive for use on a circuit that supplies not more than 100,000 RMS and not more than 480 Vac when there is a short circuit in the power supply.

The built-in short circuit protection of the drive does not provide branch circuit protection. The user must provide branch circuit protection as specified by the National Electric Code (NEC), the Canadian Electric Code, Part I (CEC), and local codes.

Three-Phase 200 V Class

Table 5.22 Factory-Recommended Branch Circuit Protection: 200 V Class (ND)

Drive Model	Maximum Applicable Motor Output kW (HP)	Input Current Rating A	Semiconductor Protection Fuse Rated Current Manufacturer: EATON/Bussmann
2004	0.75 (0.75)	4.8	FWH-45B
2006	1.1 (1.5)	6.7	FWH-45B
2010	2.2 (3)	12.7	FWH-45B
2012	3 (4)	17	FWH-50B FWH-80B <i>*1</i>
2018	3.7 (5)	20.7	FWH-80B FWH-100B <i>*1</i>
2021	5.5 (7.5)	30	FWH-80B FWH-100B <i>*1</i>
2030	7.5 (10)	40.3	FWH-125B
2042	11 (15)	52	FWH-150B
2056	15 (20)	78.4	FWH-200B
2070	18.5 (25)	96	FWH-225A
2082	22 (30)	114	FWH-225A FWH-250A <i>*1</i>
2110	30 (40)	111	FWH-225A FWH-250A <i>*1</i>
2138	37 (50)	136	FWH-275A FWH-300A <i>*1</i>
2169	45 (60)	164	FWH-275A FWH-350A <i>*1</i>
2211	55 (75)	200	FWH-325A FWH-450A <i>*1</i>
2257	75 (100)	271	FWH-600A
2313	90 (125)	324	FWH-800A
2360	110 (150)	394	FWH-1000B
2415	-	-	-

*1 Yaskawa recommends a fuse with a large rated current for applications with repeated loads.

Table 5.23 Factory-Recommended Branch Circuit Protection: 200 V Class (HD)

Drive Model	Maximum Applicable Motor Output kW (HP)	Input Current Rating A	Semiconductor Protection Fuse Rated Current Manufacturer: EATON/Bussmann
2004	0.55 (0.5)	3.6	FWH-45B
2006	0.75 (1)	4.8	FWH-45B
2010	1.5 (2)	8.9	FWH-45B
2012	2.2 (3)	12.7	FWH-50B FWH-80B <i>*1</i>
2018	3 (4)	17	FWH-80B FWH-100B <i>*1</i>
2021	3.7 (5)	20.7	FWH-80B FWH-100B <i>*1</i>
2030	5.5 (7.5)	30	FWH-125B
2042	7.5 (10)	40.3	FWH-150B
2056	11 (15)	58.2	FWH-200B
2070	15 (20)	78.4	FWH-225A

Drive Model	Maximum Applicable Motor Output kW (HP)	Input Current Rating A	Semiconductor Protection Fuse Rated Current Manufacturer: EATON/Bussmann
2082	18.5 (25)	96	FWH-225A FWH-250A <i>*/</i>
2110	22 (30)	82	FWH-225A FWH-250A <i>*/</i>
2138	30 (40)	111	FWH-275A FWH-300A <i>*/</i>
2169	37 (50)	136	FWH-275A FWH-350A <i>*/</i>
2211	45 (60)	164	FWH-325A FWH-450A <i>*/</i>
2257	55 (75)	200	FWH-600A
2313	75 (100)	271	FWH-800A
2360	90 (125)	324	FWH-1000B
2415	110 (150)	394	FWH-1000B

*1 Yaskawa recommends a fuse with a large rated current for applications with repeated loads.

Three-Phase 400 V Class

Table 5.24 Factory-Recommended Branch Circuit Protection: 400 V Class (ND)

Drive Model	Maximum Applicable Motor Output kW (HP) Input Voltage < 460 V	Maximum Applicable Motor Output kW (HP) Input Voltage ≥ 460 V	Input Current Rating A	Semiconductor Protection Fuse Manufacturer: EATON/ Bussmann
4002	0.75 (1)	0.75 (1)	2.5	FWH-50B
4004	1.5 (2)	1.5 (2)	4.7	FWH-50B
4005	2.2 (3)	2.2 (3)	6.7	FWH-50B
4007	3.0 (4)	3.0 (4)	8.9	FWH-60B
4009	4.0 (5)	3.7 (5)	11.7	FWH-60B
4012	5.5 (7.5)	5.5 (7.5)	15.8	FWH-60B
4018	7.5 (10)	7.5 (10)	21.2	FWH-80B
4023	11 (15)	11 (15)	30.6	FWH-90B
4031	15 (20)	15 (20)	41.3	FWH-150B
4038	18.5 (25)	18.5 (25)	50.5	FWH-200B
4044	22 (30)	22 (30)	59.7	FWH-200B
4060	30 (40)	30 (40)	58.3	FWH-225A
4075	37 (50)	37 (50)	71.5	FWH-250A
4089	45 (60)	45 (60)	86.5	FWH-275A
4103	55 (75)	55 (75)	105	FWH-275A
4140	75 (100)	75 (100)	142	FWH-300A
4168	90 (125)	90 (125)	170	FWH-325A FWH-400A <i>*/</i>
4208	110 (150)	110 (150)	207	FWH-500A
4250	132 (175)	150 (200)	248	FWH-600A
4296	160 (200)	185 (250)	300	FWH-700A
4371	200 (250)	220 (300)	373	FWH-800A
4389	220 (300)	260 (350)	410	FWH-1000B
4453	250 (335)	300 (400)	465	FWH-1200B
4568	315 (400)	335 (450)	584	FWH-1200B
4675	355 (450)	370 (500)	657	FWH-1400A
4810	450 (603)	525 (700)	879	FWH-1200B
4930	500 (670)	600 (800)	922	FWH-1200B

5.4 UL Standards

Drive Model	Maximum Applicable Motor Output kW (HP) Input Voltage < 460 V	Maximum Applicable Motor Output kW (HP) Input Voltage ≥ 460 V	Input Current Rating A	Semiconductor Protection Fuse Manufacturer: EATON/ Bussmann
4H11	560 (751)	675 (900)	1091	FWH-1600A
4H12	630 (845)	750 (1000)	1158	FWH-1600A

*1 Yaskawa recommends a fuse with a large rated current for applications with repeated loads.

Table 5.25 Factory-Recommended Branch Circuit Protection: 400 V Class (HD)

Drive Model	Maximum Applicable Motor Output kW (HP) Input Voltage < 460 V	Maximum Applicable Motor Output kW (HP) Input Voltage ≥ 460 V	Input Current Rating A	Semiconductor Protection Fuse Manufacturer: EATON/ Bussmann
4002	0.55 (0.75)	0.55 (0.75)	1.9	FWH-50B
4004	1.1 (1.5)	0.75 (1)	3.5	FWH-50B
4005	1.5 (2)	1.5 (2)	4.7	FWH-50B
4007	2.2 (3)	2.2 (3)	6.7	FWH-60B
4009	3 (4)	3 (4)	8.9	FWH-60B
4012	4.0 (5)	3.7 (5)	11.7	FWH-60B
4018	5.5 (7.5)	5.5 (7.5)	15.8	FWH-80B
4023	7.5 (10)	7.5 (10)	21.2	FWH-90B
4031	11 (15)	11 (15)	30.6	FWH-150B
4038	15 (20)	15 (20)	41.3	FWH-200B
4044	18.5 (25)	18.5 (25)	50.5	FWH-200B
4060	22 (30)	22 (30)	43.1	FWH-225A
4075	30 (40)	30 (40)	58.3	FWH-250A
4089	37 (50)	37 (50)	71.5	FWH-275A
4103	45 (60)	45 (60)	86.5	FWH-275A
4140	55 (75)	55 (75)	105	FWH-300A
4168	75 (100)	75 (100)	142	FWH-325A FWH-400A *1
4208	90 (125)	90 (125)	170	FWH-500A
4250	110 (150)	110 (150)	207	FWH-600A
4296	132 (175)	150 (200)	248	FWH-700A
4371	160 (200)	185 (250)	300	FWH-800A
4389	200 (250)	220 (300)	373	FWH-1000B
4453	220 (300)	260 (350)	410	FWH-1200B
4568	250 (335)	300 (400)	465	FWH-1200B
4675	315 (400)	335 (450)	584	FWH-1400A
4810	400 (536)	450 (600)	783	FWH-1200B
4930	450 (603)	525 (700)	830	FWH-1200B
4H11	500 (670)	600 (800)	976	FWH-1600A
4H12	560 (751)	675 (900)	1031	FWH-1600A

*1 Yaskawa recommends a fuse with a large rated current for applications with repeated loads.

◆ UL Standards Compliance for DC Power Supply Input

To comply with UL Standards, install a fuse for the DC power supply input.

Figure 5.24 shows a wiring example for a DC power supply that has two drives connected in parallel.

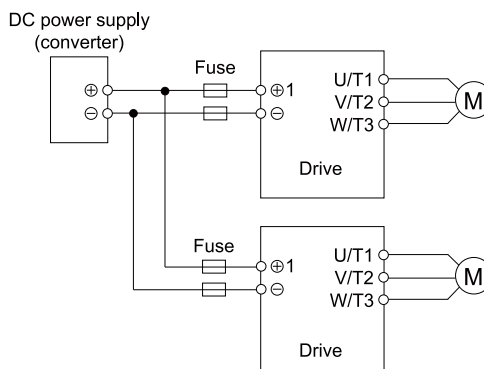

Figure 5.24 Wiring Example for DC Power Supply Input

WARNING! Electrical Shock Hazard. Do not ground the main circuit bus. Incorrect wiring can cause serious injury or death.

Note:

Install a fuse for each drive when operating more than one drive. If one fuse blows, replace all fuses.

Refer to Table 5.26 and Table 5.27 for the recommended fuses.

Table 5.26 Recommended Fuse (Three-Phase 200 V Class)

Drive Model	Fuse Manufacturer: Bussmann		Drive Model	Fuse Manufacturer: Bussmann	
	Model	Qty		Model	Qty
2004	FWH-45B	2	2110	FWH-250A FWH-275A ^{*1}	2
2006	FWH-45B	2	2138	FWH-300A FWH-350A ^{*1}	2
2010	FWH-45B	2	2169	FWH-350A FWH-450A ^{*1}	2
2012	FWH-50B	2	2211	FWH-450A FWH-600A ^{*1}	2
2018	FWH-80B	2	2257	FWH-600A FWH-700A ^{*1}	2
2021	FWH-80B	2	2313	FWH-800A FWH-1000B ^{*1}	2
2030	FWH-125B	2	2360	FWH-1000B	2
2042	FWH-150B	2	2415	FWH-1000B	2
2056	FWH-200B	2			
2070	FWH-250A	2			
2082	FWH-250A FWH-300A ^{*1}	2			

*1 Yaskawa recommends a fuse with a large rated current for applications with repeated loads of approximately 150%.

Table 5.27 Recommended Fuse (Three-Phase 400 V Class)

Drive Model	Fuse Manufacturer: Bussmann		Drive Model	Fuse Manufacturer: Bussmann	
	Model	Qty		Model	Qty
4002	FWH-50B	2	4089	FWH-275A	2
4004	FWH-50B	2	4103	FWH-275A	2
4005	FWH-50B	2	4140	FWH-300A FWH-325A ^{*1}	2
4007	FWH-60B	2	4168	FWH-400A FWH-450A ^{*1}	2
4009	FWH-60B	2	4208	FWH-500A FWH-600A ^{*1}	2
4012	FWH-60B	2	4250	FWH-600A FWH-700A ^{*1}	2
4018	FWH-80B	2	4296	FWH-700A FWH-800A ^{*1}	2
4023	FWH-90B	2	4371	FWH-800A FWH-1000B ^{*1}	2
4031	FWH-150B	2	4389	FWH-1000B FWH-1200B ^{*1}	2
4038	FWH-200B	2			
4044	FWH-200B	2			
4060	FWH-225A	2			
4075	FWH-250A	2			

Drive Model	Fuse Manufacturer: Bussmann	
	Model	Qty
4453	FWH-1200B FWH-1400A */	2
4568	FWH-1200B FWH-1600A */	2
4675	FWH-1600A	2

Drive Model	Fuse Manufacturer: Bussmann	
	Model	Qty
4810	-	-
4930	-	-
4H11	-	-
4H12	-	-

*1 Yaskawa recommends a fuse with a large rated current for applications with repeated loads of approximately 150%.

◆ Low Voltage Wiring for Control Circuit Terminals

You must provide low voltage wiring as specified by the National Electric Code (NEC), the Canadian Electric Code, Part I (CEC), and local codes. Yaskawa recommends the NEC class 1 circuit conductor. Use the UL approved class 2 power supply for external power supply.

Table 5.28 Control Circuit Terminal Power Supplies

Input/Output	Terminals	Power Supply Specifications
Digital input	S1 to S8, SN, SC, SP	Uses the LVLC power supply in the drive. Use the UL Listed class 2 power supply for external power supply.
Analog input	A1 to A3, AC, +V, -V	Uses the LVLC power supply in the drive. Use the UL Listed class 2 power supply for external power supply.
Analog output	FM, AM, AC	Uses the LVLC power supply in the drive.
Pulse train output	MP, AC	Uses the LVLC power supply in the drive. Use the UL Listed class 2 power supply for external power supply.
Pulse train input	RP, AC	Uses the LVLC power supply in the drive. Use the UL Listed class 2 power supply for external power supply.
Safe disable input	H1, H2, HC	Uses the LVLC power supply in the drive. Use the UL Listed class 2 power supply for external power supply.
Serial communication input/output	D+, D-, AC	Uses the LVLC power supply in the drive. Use the UL Listed class 2 power supply for external power supply.
24 V external power supply	PS, AC	Use the UL Listed class 2 power supply.

◆ Drive Motor Overload and Overheat Protection

The drive motor overload and overheat protection function complies with the National Electric Code (NEC) and the Canadian Electric Code, Part I (CEC).

Set the Motor Rated Current and *L1-01 through L1-04 [Motor Overload Protection Select]* correctly to enable motor overload and overheat protection.

Refer to the control method and set the motor rated current with *E2-01 [Motor Rated Current (FLA)]*, *E5-03 [PM Motor Rated Current (FLA)]*, or *E9-06 [Motor Rated Current (FLA)]*.

■ E2-01: Motor Rated Current (FLA)

No. (Hex.)	Name	Description	Default (Range)
E2-01 (030E)	Motor Rated Current (FLA)	Vf CL-Vf OLV CLV AOLV OLV/PM AOLV/PM CLV/PM EZOLV Sets the motor rated current in amps.	Determined by o2-04, C6-01 (10% to 200% of the drive rated current)

Note:

- If *E2-01 < E2-03 [Motor No-Load Current]*, the drive will detect *oPE02 [Parameter Range Setting Error]*.
- When the drive model changes, the display units for this parameter also change.
 -0.01 A: models 2004 - 2042, 4002 - 4023
 -0.1 A: models 2056 - 2415, 4031 - 4H12

The value set for *E2-01* becomes the reference value for motor protection, the torque limit, and torque control. Enter the motor rated current written on the motor nameplate. Auto-Tuning the drive will automatically set *E2-01* to the value input for “Motor Rated Current”.

■ E5-03: PM Motor Rated Current (FLA)

No. (Hex.)	Name	Description	Default (Range)
E5-03 (032B)	Motor Rated Current (FLA)	V/f CL-V/f OLV CLV AOLV OLV/PM AOLV/PM CLV/PM EZOLV Sets the PM motor rated current (FLA).	Determined by E5-01 (10% to 200% of the drive rated current)

Note:

The display units are different for different models:

- 0.01 A: models 2004 - 2042, 4002 - 4023
- 0.1 A: models 2056 - 2415, 4031 - 4H12

The drive automatically sets *E5-03* to the value input for “PM Motor Rated Current” after you do these types of Auto-Tuning:

- Manual Entry w/ Motor Data Sheet
- PM Stationary Auto-Tuning
- Stationary (R Only)
- Rotational (Ld, Lq, R, back-EMF)

■ E9-06: Motor Rated Current (FLA)

No. (Hex.)	Name	Description	Default (Range)
E9-06 (11E9)	Motor Rated Current (FLA)	V/f CL-V/f OLV CLV AOLV OLV/PM AOLV/PM CLV/PM EZOLV Sets the motor rated current in amps.	Determined by E9-01 and o2-04 (10% to 200% of the drive rated current)

Note:

The display units are different for different models:

- 0.01 A: models 2004 - 2042, 4002 - 4023
- 0.1 A: models 2056 - 2415, 4031 - 4H12

The setting value of *E9-06* is the reference value for motor protection. Enter the motor rated current written on the motor nameplate. Auto-Tuning the drive will automatically set *E9-06* to the value input for “Motor Rated Current”.

■ L1-01: Motor Overload (oL1) Protection

No. (Hex.)	Name	Description	Default (Range)
L1-01 (0480)	Motor Overload (oL1) Protection	V/f CL-V/f OLV CLV AOLV OLV/PM AOLV/PM CLV/PM EZOLV Sets the motor overload protection with electronic thermal protectors.	Determined by A1-02 (0 - 6)

This parameter enables and disables the motor overload protection with electronic thermal protectors.

The cooling capability of the motor changes when the speed control range of the motor changes. Use an electronic thermal protector that aligns with the permitted load characteristics of the motor to select motor protection.

The electronic thermal protector of the drive uses these items to calculate motor overload tolerance and supply overload protection for the motor:

- Output current
- Output frequency
- Motor thermal characteristics
- Time characteristics

If the drive detects motor overload, the drive will trigger an *oL1* [Motor Overload] and stop the drive output.

Set *H2-01* = 1F [Term M1-M2 Function Selection = Motor Overload Alarm (oL1)] to set a motor overload alarm.

If the motor overload level is more than 90% of the *oL1* detection level, the output terminal activates and triggers an overload alarm.

0 : Disable

Disable motor protection when motor overload protection is not necessary or when the drive is operating more than one motor.

Refer to [Figure 5.25](#) for an example of the circuit configuration to connect more than one motor to one drive.

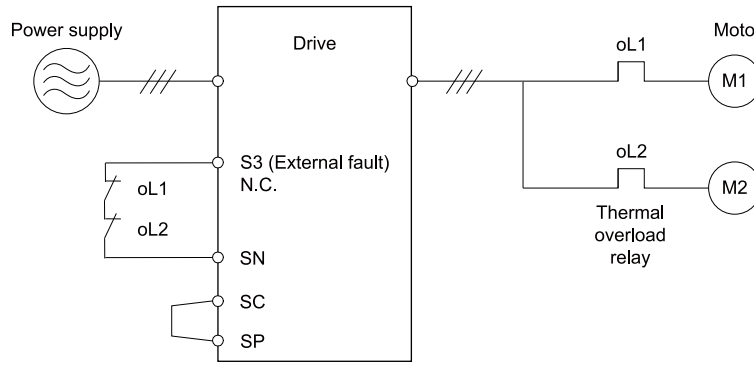

Figure 5.25 Protection Circuit Configuration to Connect More than One Motor to One Drive

NOTICE: When you connect more than one motor to one drive or when the motor amp rating is higher than the drive amp rating, set L1-01 = 0 [Motor Overload (oL1) Protection = Disabled] and install thermal overload relays for each motor. The electronic thermal protection of the drive will not function and it can cause damage to the motor.

1 : Variable Torque

Use this setting for general-purpose motors with a 60 Hz base frequency.

The overload tolerance decreases as motor speed decreases because the cooling fan speed decreases and the ability of the motor to cool decreases in the low speed range.

The overload tolerance characteristics of the motor change the trigger point for the electronic thermal protector. This provides motor overheat protection from low speed to high speed across the full speed range.

Load Tolerance	Cooling Capability	Overload Characteristics (at 100% motor load)
	<p>This motor is designed to operate with commercial line power. Operate at a 60 Hz base frequency to maximize the motor cooling ability.</p>	<p>If the motor operates at frequencies less than 60 Hz, the drive will detect oL1. The drive triggers a fault relay output and the motor coasts to stop.</p>

2 : Constant Torque 10:1 Speed Range

Use this setting for drive-dedicated motors with a speed range for constant torque of 1:10.

The speed control for this motor is 10% to 100% when at 100% load. Operating slower than 10% speed at 100% load will cause motor overload.

Load Tolerance	Cooling Capability	Overload Characteristics (at 100% motor load)
	<p>This motor is designed to withstand increased temperatures during continuous operation in the low speed range (10% base frequency).</p>	<p>The motor operates continuously at 10% to 100% base frequency. Operating slower than 10% speed at 100% load will cause motor overload.</p>

3 : Constant Torque 100:1 SpeedRange

Use this setting for vector motors with a speed range for constant torque of 1:100.

The speed control for this motor is 1% to 100% when at 100% load. Operating slower than 1% speed at 100% load will cause motor overload.

Load Tolerance	Cooling Capability	Overload Characteristics (at 100% motor load)
	<p>This motor is designed to withstand increased temperatures during continuous operation in the low speed range (1% base frequency).</p>	<p>The motor operates continuously at 1% to 100% base frequency. Operating slower than 1% speed at 100% load will cause motor overload.</p>

4 : PM Variable Torque

Use this setting for PM motors with derated torque characteristics.

The overload tolerance decreases as motor speed decreases because the cooling fan speed decreases and the ability of the motor to cool decreases in the low speed range.

The overload tolerance characteristics of the motor change the trigger point for the electronic thermal protector. This provides motor overheat protection from low speed to high speed across the full speed range.

Load Tolerance	Cooling Capability	Overload Characteristics (at 100% motor load)
	<p>This motor is designed to withstand increased temperatures during continuous operation at rated speed and rated torque.</p>	<p>If the motor operates continuously at lower speed than rated rotation speed at more than 100% torque, the drive will detect <i>oLL</i>. The drive triggers a fault relay output and the motor coasts to stop.</p>

5 : PM Constant Torque

Use this setting with a PM motor for constant torque that has a speed range for constant torque of 1:500.

The speed control for this motor is 0.2% to 100% when at 100% load. Operating slower than 0.2% speed at 100% load will cause motor overload.

Load Tolerance	Cooling Capability	Overload Characteristics (at 100% motor load)
	<p>This motor is designed to withstand increased temperatures during continuous operation in the low speed range (0.2% base frequency).</p>	<p>The motor operates continuously at 0.2% to 100% rated speed. Operating slower than 0.2% speed at 100% load will cause motor overload.</p>

6 : Variable Torque (50Hz)

Use this setting for general-purpose motors with a 50 Hz base frequency.

The overload tolerance decreases as motor speed decreases because the cooling fan speed decreases and the ability of the motor to cool decreases in the low speed range.

The overload tolerance characteristics of the motor change the trigger point for the electronic thermal protector. This provides motor overheat protection from low speed to high speed across the full speed range.

Load Tolerance	Cooling Capability	Overload Characteristics (at 100% motor load)
	<p>This motor is designed to operate with commercial line power. Operate at a 50 Hz base frequency to maximize the motor cooling ability.</p>	<p>If the motor operates at frequencies less than commercial line power, the drive will detect <i>oLL</i>. The drive triggers a fault relay output and the motor coasts to stop.</p>

■ L1-02: Motor Overload Protection Time

No. (Hex.)	Name	Description	Default (Range)
L1-02 (0481)	Motor Overload Protection Time	<p>V/f CL-V/f OLV CLV AOLV OLV/PM AOLV/PM CLV/PM EZOLV</p> <p>Sets the operation time for the electronic thermal protector of the drive to prevent damage to the motor. Usually it is not necessary to change this setting.</p>	1.0 min (0.1 - 5.0 min)

Set the overload tolerance time to the length of time that the motor can operate at 150% load from continuous operation at 100% load.

When the motor operates at 150% load continuously for 1 minute after continuous operation at 100% load (hot start), the default setting triggers the electronic thermal protector.

Figure 5.26 shows an example of the electronic thermal protector operation time. Motor overload protection operates in the range between a cold start and a hot start.

This example shows a general-purpose motor operating at the base frequency with L1-02 set to 1.0 min.

- Cold start
Shows the motor protection operation time characteristics when the overload occurs immediately after starting operation from a complete stop.
- Hot start
Shows the motor protection operation time characteristics when overload occurs from continuous operation below the motor rated current.

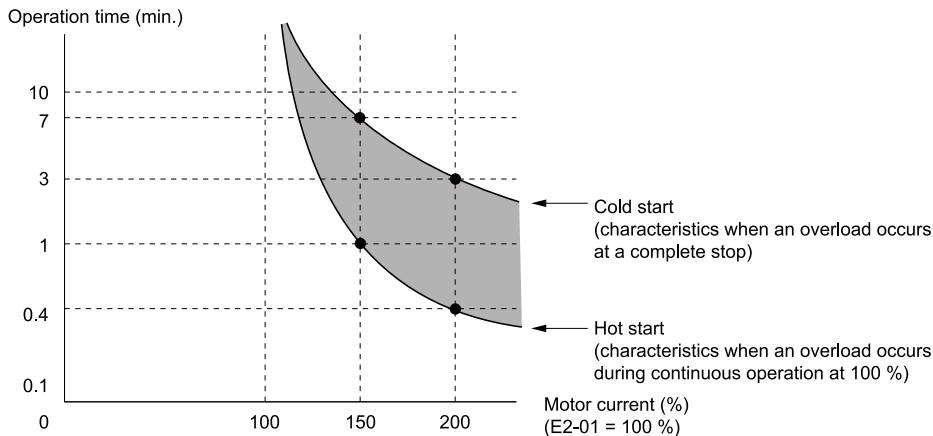

Figure 5.26 Protection Operation Time for a General-purpose Motor at Rated Output Frequency

■ L1-03: Motor Thermistor oH Alarm Select

No. (Hex.)	Name	Description	Default (Range)
L1-03 (0482)	Motor Thermistor oH Alarm Select	<p>V/f CL-V/f OLV CLV AOLV OLV/PM AOLV/PM CLV/PM EZOLV</p> <p>Sets drive operation when the PTC input signal entered into the drive is at the oH3 [Motor Overheat Alarm] detection level.</p>	3 (0 - 3)

0 : Ramp to Stop

The drive ramps the motor to stop in the deceleration time. Fault relay output terminal MA-MC turns ON, and MB-MC turns OFF.

1 : Coast to Stop

The output turns off and the motor coasts to stop. Fault relay output terminal MA-MC turns ON, and MB-MC turns OFF.

2 : Fast Stop (Use C1-09)

The drive stops the motor in the deceleration time set in *C1-09 [Fast Stop Time]*. Fault relay output terminal MA-MC turns ON, and MB-MC turns OFF.

3 : Alarm Only

The keypad shows *oH3* and the drive continues operation. The output terminal set for *Alarm [H2-01 to H2-03 = 10]* activates.

■ L1-04: Motor Thermistor oH Fault Select

No. (Hex.)	Name	Description	Default (Range)
L1-04 (0483)	Motor Thermistor oH Fault Select	<div style="display: flex; justify-content: space-between; align-items: center;"> V/f CL-V/f OLV CLV AOLV OLV/PM AOLV/PM CLV/PM EZOLV </div> <p>Sets the drive operation when the PTC input signal to the drive is at the <i>oH4 [Motor Overheat Fault (PTC Input)]</i> detection level.</p>	1 (0 - 2)

0 : Ramp to Stop

The drive ramps the motor to stop in the deceleration time. Fault relay output terminal MA-MC turns ON, and MB-MC turns OFF.

1 : Coast to Stop

The output turns OFF and the motor coasts to stop. Fault relay output terminal MA-MC turns ON, and MB-MC turns OFF.

2 : Fast Stop (Use C1-09)

The drive stops the motor in the deceleration time set in *C1-09 [Fast Stop Time]*. Fault relay output terminal MA-MC turns ON, and MB-MC turns OFF.

5.5 China RoHS Compliance



Figure 5.27 China RoHS Mark

The China RoHS mark is displayed on products containing six specified hazardous substances that are in excess of regulatory limits, based on the “Administrative Measures for the Restriction of the Use of Hazardous Substances in Electrical and Electronic Products” and “Marking for the Restricted Use of Hazardous Substances in Electronic and Electrical Products” (SJ/T 11364-2014), which were promulgated on January 26, 2016. The number displayed in the center of the mark indicates the environment-friendly use period (number of years) in which electrical and electronic products that are being produced, sold, or imported to China can be used. The date of manufacture of the electrical and electronic product is the starting date of the environment-friendly use period for the product. The six specified hazardous substances contained in the product will not leak outside of the product during normal use within this period and will have no serious impact on the environment, the human body, or property.

The environment-friendly use period for this product is 15 years. This period is not the product warranty period.

◆ Information on Hazardous Substances in This Product

Table 5.29 shows the details on hazardous substances contained in this product.

Table 5.29 Contents of Hazardous Substances in This Product

Parts Name	Hazardous Substances					
	Lead (Pb)	Mercury (Hg)	Cadmium (Cd)	Hexavalent Chromium (Cr(VI))	Polybrominated Biphenyls (PBB)	Polybrominated Diphenyl Ethers (PBDE)
Circuit Board	×	○	○	○	○	○
Electronic Parts	×	○	○	○	○	○
Brass Screw	×	○	○	○	○	○
Aluminum Die Casting	×	○	○	○	○	○

This table has been prepared in accordance with the provisions outlined in SJ/T 11364.
 ○: Indicates that said hazardous substance contained in all of the homogeneous materials for this part is below or equal to the limit requirement of GB/T 26572.
 ×: Indicates that said hazardous substance contained in at least one of the homogeneous materials used for this part is above the limit requirement of GB/T 26572.

Note:
 This product complies with EU RoHS directives. In this table, "×" indicates that hazardous substances that are exempt from EU RoHS directives are contained.

5.6 对应中国RoHS指令



图 5.28 中国RoHS标志

中国RoHS标志依据2016年1月26日公布的《电器电子产品有害物质限制使用管理办法》，以及《电子电气产品有害物质限制使用标识要求》（SJ/T 11364-2014）作成。电子电气产品中特定6种有害物质的含量超过规定值时，应标识此标志。中间的数字为在中国生产销售以及进口的电子电气产品的环保使用期限（年限）。电子电气产品的环保使用期限从生产日期算起。在期限内，正常使用产品的过程中，不会有特定的6种有害物质外泄进而对环境、人和财产造成深刻影响。

本产品的环保使用期限为15年。但需要注意的是环保使用期限并非产品的质量保证期限。

◆ 本产品中含有有害物质的信息

本产品中所含有害物质的详细信息如表 5.30 所示。

表 5.30 本产品中有害物质的名称及含量

部件名称	有害物质					
	铅 (Pb)	汞 (Hg)	镉 (Cd)	六价铬 (Cr(VI))	多溴联苯 (PBB)	多溴二苯醚 (PBDE)
实装基板	×	○	○	○	○	○
电子元件	×	○	○	○	○	○
黄铜螺钉	×	○	○	○	○	○
铝压铸	×	○	○	○	○	○

本表格依据SJ/T 11364的规定编制。
 ○:表示该有害物质在该部件所有均质材料中的含量均在GB/T 26572规定的限量要求以下。
 ×:表示该有害物质至少在该部件的某一均质材料中的含量超出GB/T 26572规定的限量要求。
 (注) 本产品符合欧盟RoHS指令。上表中的“×”表示含有欧盟RoHS指令豁免的有害物质。

5.7 Safe Disable Input

This section gives precautions to support the Safe Disable input. Contact Yaskawa for more information. The safety function complies with the standards shown in [Table 5.31](#).

Table 5.31 Applied Safety Standards and Unified Standards

Safety Standards	Unified Standards
Functional Safety	IEC/EN 61508 (SIL3)
	IEC/EN 62061 (SILCL3)
	IEC/EN 61800-5-2 (SIL3)
Machine Safety	ISO/EN ISO 13849-1:2015 (Cat.3, PL e)
EMC	IEC/EN 61000-6-7

Note:

- SIL = Safety Integrity Level.
- SILCL = SIL Claim Limit.

◆ Safe Disable Specifications

The Safe Disable input provides the stop function that complies with “Safe Torque Off” as specified by IEC/EN 61800-5-2. The Safe Disable input meets the requirements of EN ISO 13849-1 and IEC/EN 61508. It also has a safety status monitor to detect safety circuit errors.

When you install the drive as a component in a system, you must make sure that the system complies with the applicable safety standards.

Refer to [Table 5.32](#) for safety function specifications.

Table 5.32 Safe Disable Specifications

Item	Description
Input/Output	<ul style="list-style-type: none"> • Input: 2 Safe Disable input (H1, H2) Signal ON level: 18 Vdc to 28 Vdc Signal OFF level: -4 Vdc to +4 Vdc • Output: 1 MFDO safety monitor output for external device monitor (EDM)
Response time from when the input opens to when the drive output stops	3 ms or less
Response time from when the H1 and H2 terminal inputs open to when the EDM signal operates	20 ms or less
Failure probability	Less frequent operation request mode
	Frequent operation request mode or continuous mode
Performance level	The Safe Disable input complies with the performance level requirements of EN ISO 13849-1.
HFT (hardware fault tolerance)	N = 1
Type of subsystem	Type B

Note:

- EDM = External Device Monitoring
- PFD = Probability of Failure on Demand
- PFH = Probability of Dangerous Failure per Hour

◆ Notes

DANGER! Sudden Movement Hazard. When you use the Safe Disable function in the safety system of a machine, do a full risk assessment for the system to make sure that all parts of the system comply with applicable safety standards. Incorrect application of the Safe Disable function can cause serious injury or death.

DANGER! Sudden Movement Hazard. If the output circuit of the drive is damaged and the Safe Disable function turns OFF the drive output to a permanent magnet (PM) motor, the motor can rotate 180 electrical degrees. Prevent damage to equipment and injury to personnel during this condition. Sudden motor movement can cause serious injury or death. It is possible for current to flow through the motor winding in these conditions.

DANGER! Electrical Shock Hazard. You cannot depend on the Safe Disable function to prevent electrical shock. Disconnect all power to the drive and wait for the time specified on the warning label before you remove covers. Check the drive for dangerous voltages before servicing or repair work. If you do work on the drive when it is energized and there is no cover over the electronic circuits, it can cause serious injury or death.

WARNING! Sudden Movement Hazard. Although the Safe Disable function is in operation, gravity or other external forces in the vertical axis can move the motor. Incorrect application of the Safe Disable function can cause serious injury or death.

WARNING! Sudden Movement Hazard. Do not use the drive output signals to control external holding brakes or dynamic brakes for functional safety. Use a system that conforms to the functional safety requirements. Incorrect application of the Safe Disable function can cause serious injury or death. Systems that use drive output signals (including EDM) for safety are not safe because drive output signals are not safety components.

WARNING! Sudden Movement Hazard. Connect the Safe Disable inputs to the devices as specified by the safety requirements. If you connect the Safe Disable inputs incorrectly, it can cause serious injury or death.

WARNING! Sudden Movement Hazard. To use the Safe Disable inputs, remove the jumpers between terminals H1-HC and H2-HC. If the Safe Disable circuit does not work correctly, it can cause serious injury or death.

WARNING! Sudden Movement Hazard. When you clear the Safe Disable input, make sure that the Safe Disable Monitor output operates correctly as the specification for Safe Disable function. If the Safe Disable circuit does not operate correctly, it can cause serious injury or death.

WARNING! Sudden Movement Hazard. Regularly examine the Safe Disable input and all other safety features. A system that does not operate correctly can cause serious injury or death.

WARNING! Sudden Movement Hazard. Only let approved personnel who know about the drive, instruction manual, and safety standards wire, examine, and maintain the Safe Disable input. If personnel are not approved, it can cause serious injury or death.

WARNING! Sudden Movement Hazard. Only use the Safe Disable Monitor (multi-function output terminal set to the EDM function) to monitor the Safe Disable status or to find a malfunction in the Safe Disable inputs. The monitor output is not a safety output. If you use the Safe Disable Monitor incorrectly, it can cause death or serious injury.

Note:

- When you use a drive with a built in safety function, you must replace it 10 years after first use.
- A maximum of 3 ms will elapse from when terminals H1 or H2 shut off until the drive switches to the “Safe Torque Off” status. Set the OFF status for terminals H1 and H2 to hold for at least 3 ms. The drive may not be able to switch to the “Safe Torque Off” status if terminals H1 and H2 are only open for less than 3 ms.

◆ Using the Safe Disable Function

■ Safe Disable Circuit

The Safe Disable circuit has two isolated channels (terminals H1 and H2) that stop the output transistors. The input can use the internal power supply of the drive.

Set the EDM function to one of the MFDO terminals [$H2-xx = 21$ or 121] to monitor the status of the Safe Disable function. This is the “Safe Disable monitor output function”.

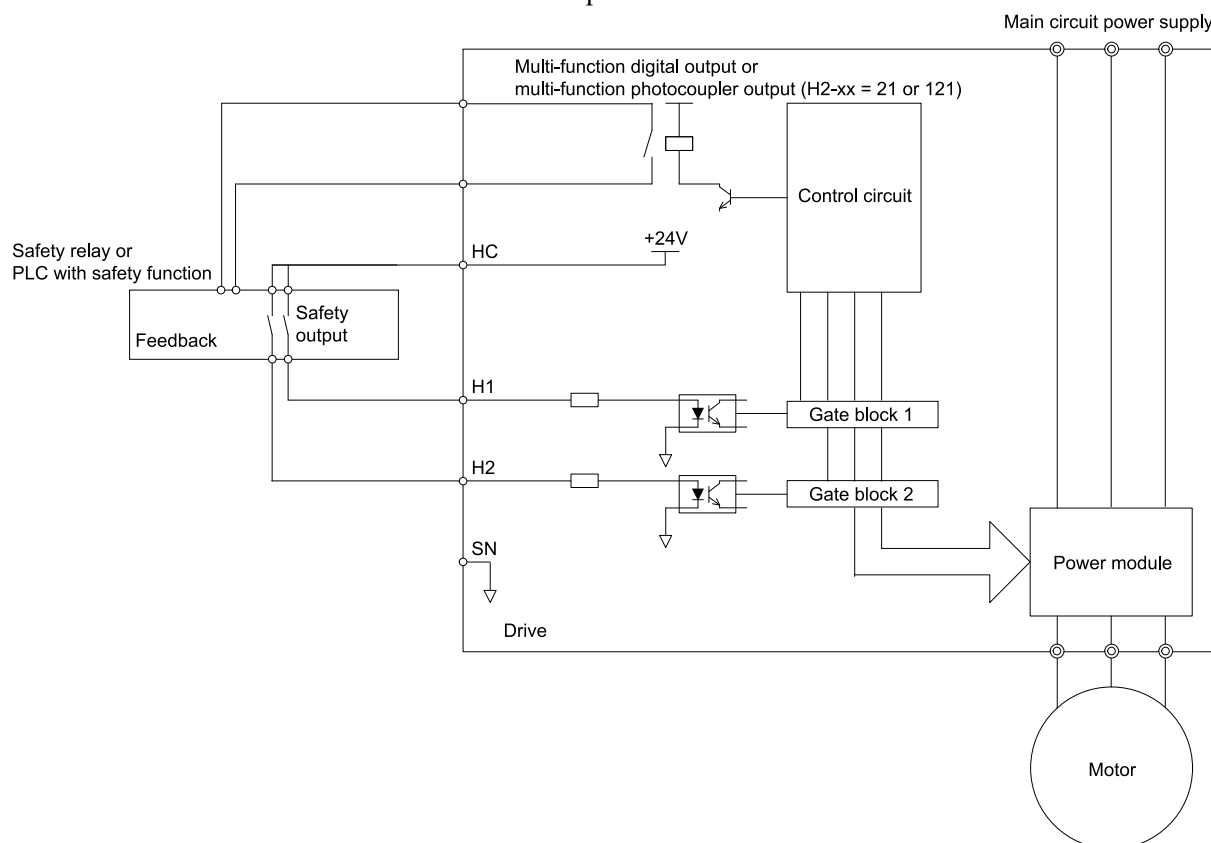

Figure 5.29 Safe Disable Function Wiring Example

■ Connect Safe Disable Input Contacts to Multiple Drives

To Use the Drive Internal Power Supply

Figure 5.30 shows an example of how to connect Safe Disable contacts.

From the terminals HC-SN of drive 1, supply the power for the Safe Disable function for the applicable drives. These conditions limit the number of units to connect:

- Internal power supply capacity
- Number of MFDIs used
- Supply current to the external sensors

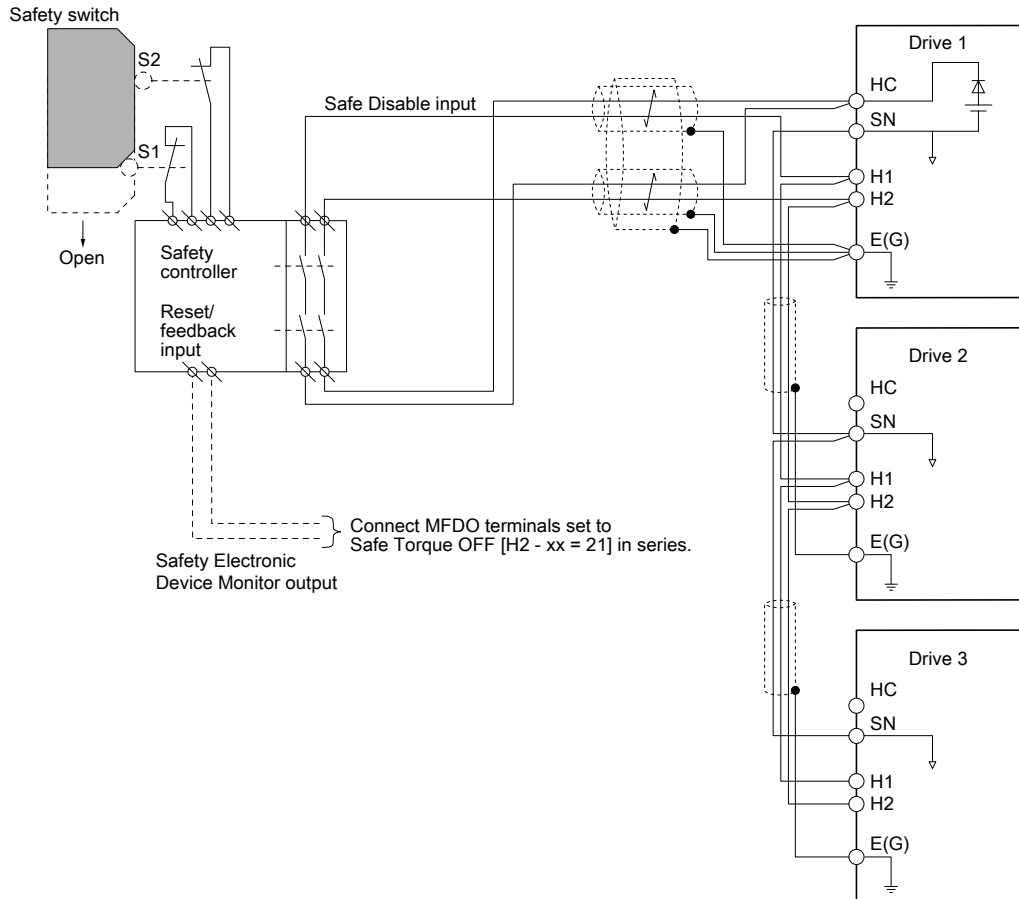

Figure 5.30 Connection Example to Use the Internal Power Supply

To Use 24 V External Power Supply

Figure 5.31 shows an example of how to connect Safe Disable contacts. These conditions limit the number of units to connect:

- External power supply capacity
- Number of MFDIs used
- Supply current to the external sensors

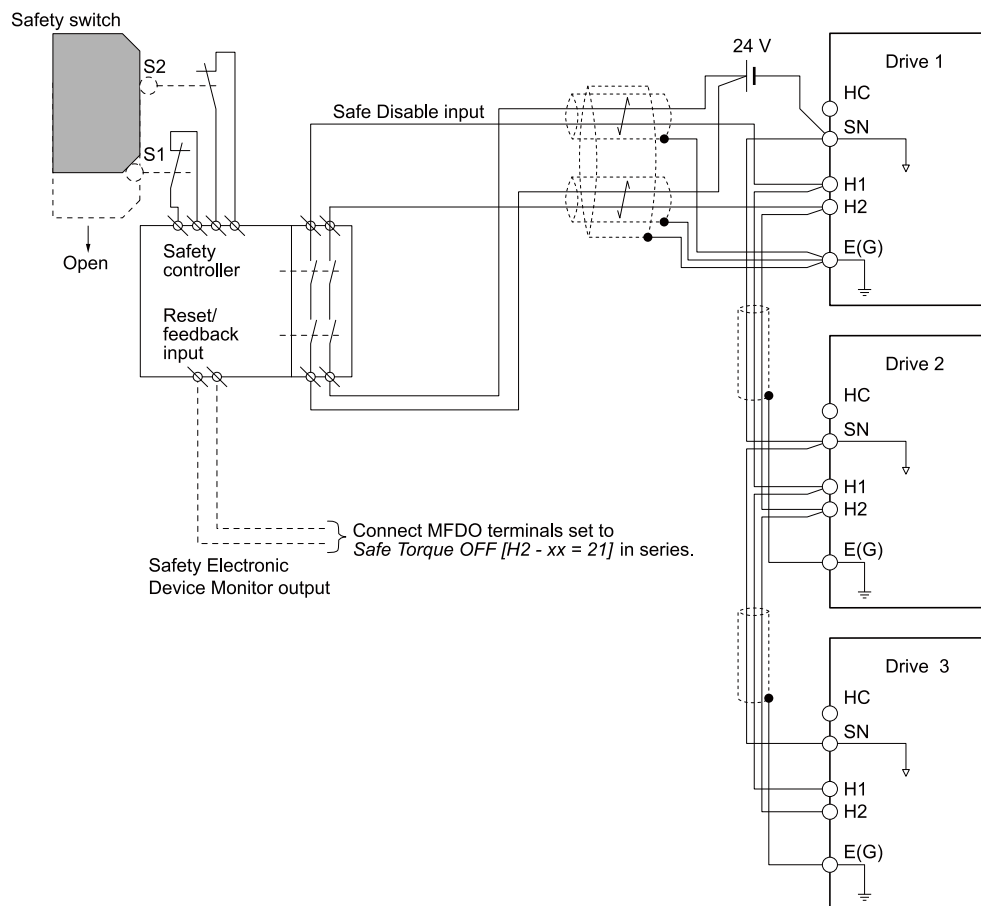

Figure 5.31 Connection Example to Use 24 V External Power Supply

The Number of Possible Units to Connect

Power Supply	MFDI	24 V Output	Number of Drive Units
Internal power supply (Drive 1)	Yes (8-channel input)	Yes *1	3
		No	15
	No	Yes *1	7
		No	19
External power supply	-	-	Different for different external power supply capacities *2

*1 This is when you use a maximum of 150 mA.

*2 24 V, 12 mA is necessary for each drive.

Use the this formula to calculate the number of units to connect:

$$n = (I_{o_{max}} - I_{MFDI} \times n_{MFDI} - I_{sensor}) / I_{safety}$$

- n: Number of units to connect
- $I_{o_{max}}$: Maximum current that can be supplied from the power supply (234 mA for the internal power supply)
- I_{MFDI} : Current consumed per MFDI (6 mA)
- n_{MFDI} : Maximum number of MFDIs that can be activated at the same time (maximum of 8-channel)
- I_{sensor} : Current externally supplied for sensor power supply (maximum of 150 mA)
- I_{safety} : Current consumed by Safe Disable terminals H1 and H2 (12 mA)

Note:

Round the values off to the first decimal place.

■ Enabling and Disabling the Drive Output (“Safe Torque Off”)

Refer to Figure 5.32 for an example of drive operation when the drive changes from “Safe Torque Off” status to usual operation.

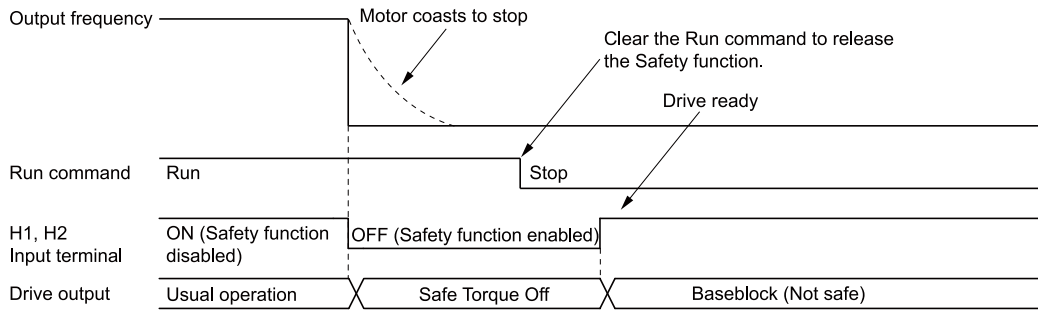

Figure 5.32 Safe Disable Operation

Switching from Usual Operation to “Safe Torque Off”

Turn OFF (open) safety input terminal H1 or H2 to enable the Safe Disable function. When the Safe Disable function is enabled while the motor is operating, the drive output and motor torque turn off and the motor always coasts to stop. The *b1-03 [Stopping Method Selection]* setting does not have an effect on the stopping method.

The “Safe Torque Off” status is only possible with the Safe Disable function. Clear the Run command to stop the drive. Turning off drive output (a baseblock condition) ≠ “Safe Torque Off”.

Note:

- When it is necessary to ramp to stop the motor, do not turn off terminals H1 and H2 until the motor fully stops. This will prevent the motor from coasting to stop during usual operation.
- A maximum of 3 ms will elapse from when terminals H1 or H2 shut off until the drive switches to the “Safe Torque Off” status. Set the OFF status for terminals H1 and H2 to hold for at least 3 ms. The drive may not be able to switch to the “Safe Torque Off” status if terminals H1 and H2 are only open for less than 3 ms.

Going from “Safe Torque Off” to Usual Operation

The safety input will only release when there is no Run command.

- **During Stop**
When the Safe Disable function is triggered during stop, close the circuit between terminals H1-HC and H2-HC to disable “Safe Torque Off”. Enter the Run command after the drive stops correctly.
- **During Run**
If you trigger the Safe Disable function during run, clear the Run command, then close the circuit between terminals H1-HC and H2-HC to disable “Safe Torque Off”. Enter the Stop command, then enter the Run command when terminals H1 and H2 are activated.

Safe Disable Monitor Output Function and Keypad Display

Refer to [Table 5.33](#) for information about the relation between the input channel status, Safety monitor output status, and drive output status.

Table 5.33 Safe Disable Input and External Device Monitor (EDM) Terminal Status

Input Channel Status	Input 1 (H1-HC)	ON (Close the circuit)	OFF (Open)	ON (Close the circuit)	OFF (Open)
	Input 2 (H2-HC)	ON (Close the circuit)	ON (Close the circuit)	OFF (Open)	OFF (Open)
MFDO Terminal (H2-xx = 21)	MFDO Terminal (H2-xx = 21)	OFF	OFF	OFF	ON
	MFDO Terminal (H2-xx = 121)	ON	ON	ON	OFF
Drive Output Status		Baseblock (Drive ready)	Safety status (STo)	Safety status (STo)	Safety status (STo)
Keypad Display		Normally displayed	SToF (Flashing)	SToF (Flashing)	STo (Flashing)
LED Status Ring		Ready: Illuminated	ALM/ERR: Flashing	ALM/ERR: Flashing	Ready: Flashing
MEMOBUS Register 0020 (Hex.)		bit C: 0 bit D: 0	bit C: 1 bit D: 0	bit C: 1 bit D: 0	bit C: 0 bit D: 1

Safety Function Status Monitor

The drive Safety monitor output sends a feedback signal about the status of the Safety function. The Safety monitor output is one of the possible settings available for the MFDO terminals. If there is damage to the Safe Disable circuit, a controller (PLC or safety relay) must read this signal as an input signal to hold the “Safe Torque Off” status. This will help verify the condition of the safety circuit. Refer to the manual for the safety device for more information about the Safety function.

You can use the MFDO function settings to switch the polarity of the Safety monitor output signal. Refer to [Table 5.33](#) for setting instructions.

Keypad Display

If the two input channels are OFF (Open), the keypad will flash *STo* [*Safe Torque OFF*].

If there is damage to the Safe disable circuit or the drive, the keypad will flash *SToF* [*Safe Torque OFF Hardware*] when one input channel is OFF (Open) and the other is ON (Close the circuit). When you use the Safe disable circuit correctly, the keypad will not show *SToF*.

If there is damage to the drive, the keypad will show *SCF* [*Safety Circuit Fault*] when the drive detects a fault in the Safe disable circuit. Refer to the chapter on Troubleshooting for more information.

■ Validating the Safe Disable Function

After you replace parts or do maintenance on the drive, first complete all necessary wiring to start the drive, then test the Safe Disable input with these steps. Keep a record of the test results.

Note:

This validation should be performed at least once every three months in order to guarantee the specification values of the safety parameters.

1. When the two input channels are OFF (Open), make sure that the keypad flashes *STo* [*Safe Torque OFF*], and make sure that the motor is not running.
2. Monitor the ON/OFF status of the input channels and make sure that MFDO set to the EDM function operates as shown in [Table 5.33](#).
If one or more of these items are true, the ON/OFF status of the MFDO may not display correctly on the keypad:
 - Incorrect parameter settings.
 - A problem with an external device.
 - The external wiring has a short circuit or is disconnected.
 - There is damage to the device.
 Find the cause and repair the problem to correctly display the status.
3. Make sure that the EDM signal operates during usual operation as shown in [Table 5.33](#).

Network Communications

6.1	Section Safety	298
6.2	Field Bus Network Support.....	299
6.3	MEMOBUS/Modbus Communications	300

6.1 Section Safety

 **DANGER**

Do not ignore the safety messages in this manual.

If you ignore the safety messages in this manual, it will cause serious injury or death. The manufacturer is not responsible for injuries or damage to equipment.

6.2 Field Bus Network Support

You can use the PLC to control and monitor the drive through the network. The drive has a standard RS-485 interface (MEMOBUS/Modbus communications). Install a separately sold communication option on the drive to support other network communications.

◆ Available Communication Options

Refer to for the fieldbus networks that are compatible with the drive. Contact Yaskawa or your nearest sales representative to order a communication option.

Table 6.1 Available Fieldbus Network

Type of Communications	Option model	Type of Communications	Option model
CC-Link	SI-C3	Modbus TCP/IP	SI-EM3, JOHB-SMP3
MECHATROLINK-II	SI-T3	PROFINET	SI-EP3, JOHB-SMP3
MECHATROLINK-III	SI-ET3	EtherNet/IP	SI-EN3, JOHB-SMP3
PROFIBUS-DP	SI-P3	EtherCAT	SI-ES3, JOHB-SMP3
CANopen	SI-S3	Powerlink	SI-EL3
DeviceNet	SI-N3		

6.3 MEMOBUS/Modbus Communications

This section gives detailed information about the parameters, error codes and communication procedures for MEMOBUS/Modbus communications.

◆ Configure Master/Slave

You can use the MEMOBUS/Modbus protocol for serial communication with programmable controllers (PLC). The MEMOBUS/Modbus communication uses one master (PLC) and a maximum of 31 slave drives. Serial communications usually starts with a signal from the master to the slave drives.

A slave drive that receives a command from the master does the specified function and then sends a response back to the master. You must set the address number for each slave drive before you start signal communications to make sure that the master uses the correct address numbers.

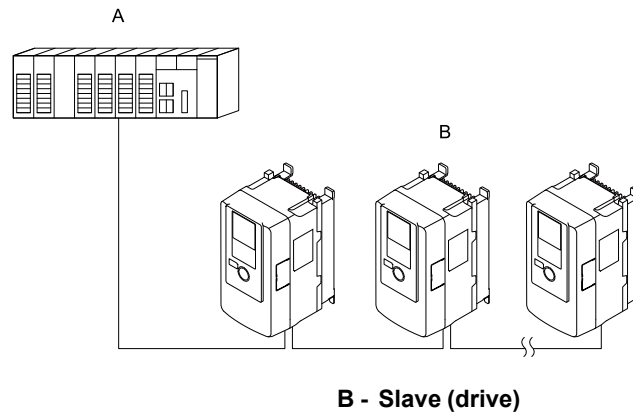

A - Master (PLC)

B - Slave (drive)

Figure 6.1 PLC and Drive Connection Example

◆ Communication Specifications

Table 6.2 lists the specifications for the MEMOBUS/Modbus communications.

Table 6.2 MEMOBUS/Modbus Specifications

Item	Specification
Interface	RS-485
Synchronization method	Asynchronous (start-stop synchronization)
Communication parameter	Communications speed: 1.2, 2.4, 4.8, 9.6, 19.2, 38.4, 57.6, 76.8, 115.2 kbps
	Data length: 8 bit (fixed)
	Parity: even, odd, none
	Stop bit 1 bit (fixed)
Communication protocol	MEMOBUS/Modbus standard (RTU mode only)
Number of possible units to connect	Maximum: 31 units

◆ Communication with the PLC

This section gives information about the settings for the termination resistor and how to connect to MEMOBUS/Modbus communications. MEMOBUS/Modbus communications uses an RS-485 interface (2-wire sequence).

■ Connect Communications Cable

Use this procedure to start communication between the PLC and drive.

1. De-energize the drive then connect the communications cable to the PLC and the drive. The drive uses terminal TB4 for MEMOBUS/Modbus communications.

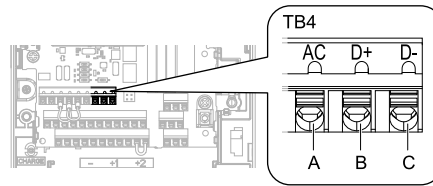

A - Terminal AC: Shield ground

B - Terminal D+: Communication input/output (+)

C - Terminal D-: Communication input/output (-)

Figure 6.2 Communications Cable Connection Terminal (TB4)

Note:

Isolate the communications wiring from the main circuit wiring and other high-power wiring. Use shielded wires for the communications wiring and connect cable sheaths to the ground terminal of the drive. Incorrect wiring procedures could cause drive malfunction because of electrical interference.

2. Install the termination resistor on the network termination slave drive. Set DIP switch S2 to the ON position to enable the termination resistor on the drive.
3. Energize the drive.
4. Use the drive keypad to set the necessary communications parameters *H5-01 to H5-12*.
 - *H5-01 [Drive Node Address]*
 - *H5-02 [Communication Speed Selection]*
 - *H5-03 [Communication Parity Selection]*
 - *H5-04 [Communication Error Stop Method]*
 - *H5-05 [Comm Fault Detection Selection]*
 - *H5-06 [Drive Transmit Wait Time]*
 - *H5-09 [CE Detection Time]*
 - *H5-10 [Modbus Register 0025H Unit Sel]*
 - *H5-11 [Comm ENTER Command Mode]*
 - *H5-12 [Run Command Method Selection]*
5. De-energize the drive and wait for the keypad display to turn off.
6. Energize the drive.

The drive is prepared to start communication with the PLC.

■ Set the Termination Resistor

You must enable the termination resistor on the slave terminal of the drive to use MEMOBUS/Modbus communications. Use DIP switch S2 on the terminal block to enable and disable the built-in termination resistor. Refer to [Figure 6.3](#) for an example of how to set DIP switch S2. Use the tip of a tweezers or a jig with a tip width of 0.8 mm (0.03 in) to set the DIP switch. When you install the drive at the end of the communication line, set DIP switch S2 to ON. Set DIP switch S2 to OFF on all other drives.

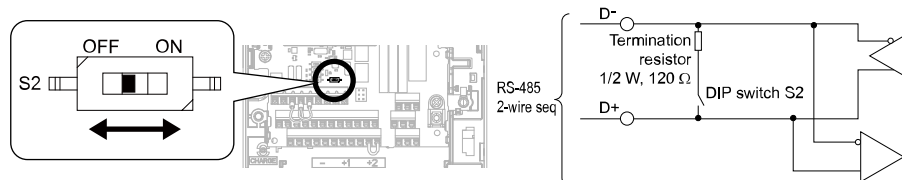

Figure 6.3 MEMOBUS/Modbus Communication Terminal and DIP Switch S2

■ Wiring Diagram for More than One Drive

[Figure 6.4](#) shows how to wire more than one connected drive with using MEMOBUS/Modbus communications.

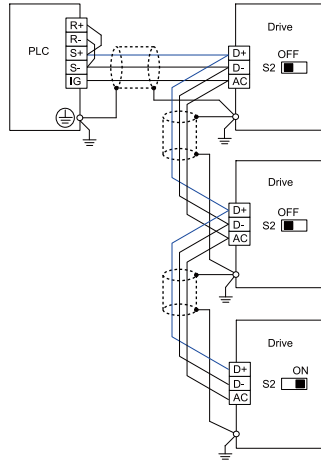

Figure 6.4 Wiring Diagram for More than One Drive

Note:

Set DIP switch S2 to the ON position on the last drive of the MEMOBUS/Modbus communication network to enable the termination resistor.

◆ **MEMOBUS/Modbus Drive Operations**

Drive parameters will apply to the settings when the drive is running during MEMOBUS/Modbus communications. This section gives information about the available functions and their related parameters.

■ **Executable Functions**

A PLC can do these operations with MEMOBUS/Modbus communications. Parameter settings (except *H5-xx*) do not have an effect on the availability of these operations.

- Monitor the drive status and operate the drive
- Set and view parameters
- Fault Reset
- Multi-function input setting (The input command from MEMOBUS/Modbus communications and MFDI terminals (S1 to S8) are linked by a logical OR operation.)

■ **Drive Control**

Select the external command that sets the frequency references and motor run/stop with MEMOBUS/Modbus communications. Use the information in Table 6.3 to set the parameters as specified by the application.

Table 6.3 Necessary Parameter Settings for Drive Control from MEMOBUS/Modbus

LOCAL Control Selected	No.	Name	Setting Value
External reference 1	b1-01	Frequency Reference Selection 1	2 [<i>Memobus/Modbus Communications</i>]
	b1-02	Run Command Selection 1	2 [<i>Memobus/Modbus Communications</i>]
External reference 2	b1-15	Frequency Reference Selection 2	2 [<i>Memobus/Modbus Communications</i>]
	b1-16	Run Command Selection 2	2 [<i>Memobus/Modbus Communications</i>]

For more information about operation mode selection, refer to [*Frequency Reference Selection 1*] and *b1-02* [*Run Command Selection 1*]. Refer to *H1-xx = 2* [*MFDI Function Select = External Reference 1/2 Selection*] for more information about external commands.

◆ **Communications Timing**

To prevent overrun of the slave side, the master cannot send a message to the same drive for a selected length of time.

To prevent overrun of the master side, the slave cannot send a response message to the master for a selected length of time.

This section gives information about message timing.

■ Command Message from Master to Slave

To prevent data loss and overrun, after the master receives a message from the slave, the master cannot send the same type of command message to the same slave for a selected length of time. The minimum wait time is different for each type of message. Refer to [Table 6.4](#) to find the minimum wait times.

Table 6.4 Minimum Wait Time to Send a Message

Command Type	Example	Minimum Wait Time
1	<ul style="list-style-type: none"> Operation commands (Run command, stop command) I/O settings Reading the motor and parameter setting values 	5 ms ^{*/1}
2	Writing a parameter	50 ms ^{*/1}
3	Writing of modified data with the Enter command	3 to 5 s ^{*/1}

*1 When the drive receives a message in the minimum wait time, it does command type 1 and sends a response message. If the drive receives command type 2 or command type 3 messages in the minimum wait time, it will trigger a communications error or the drive will ignore the command.

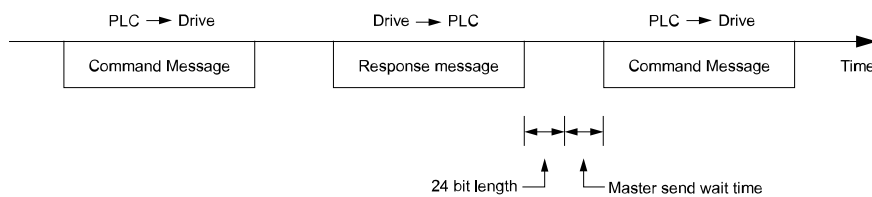

Figure 6.5 Minimum Wait Time to Send a Message

You must set the timer in the master to measure the length of time for the slave to respond to the master. If you set the timer, but the slave does not send a response message in a specified length of time, the master will send the message again.

■ Response Message from Slave

The slave receives the command message from the master then processes the data it received. The slave then waits for the time set in *H5-06 [Drive Transmit Wait Time]* then sends a response message to the master. If overrun occurs on the master, increase the wait time set in *H5-06*.

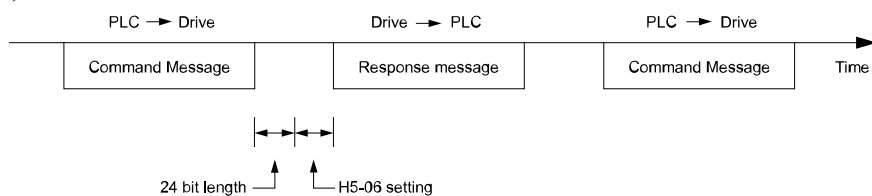

Figure 6.6 Response Wait Time

◆ Message Format

■ Communication Message Description

In MEMOBUS/Modbus communications, the master sends commands to the slave, then the slave responds. The master and slave send their messages in the configuration in [Figure 6.7](#). The length of the data changes when the description of the command (function) changes.

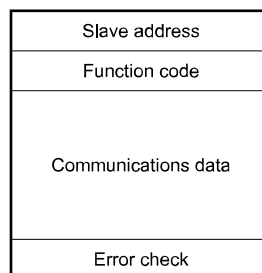

Figure 6.7 Message Format

■ Slave Address

Set the slave address of the drive to 00 to FF (Hex.). When the slave address is 00 (Hex), the master sends the command and all slaves receive the command.

The slave will not send a response message to the master.

■ Function Code

There are five function codes that set commands. [Table 6.5](#) shows the different codes.

Table 6.5 Function Codes

Function Code (Hex.)	Subfunction Code (Hex.)	Function	Command Message		Response Message	
			Minimum Data Length (byte)	Maximum Data Length (byte)	Minimum Data Length (byte)	Maximum Data Length (byte)
03	-	Read Multiple Holding Registers	8	8	7	37
08	-	Loopback Test	8	8	8	8
10	-	Writing to Multiple Holding Registers	11	41	8	8
5A	-	Writing to Multiple Holding Registers / Reading the Register Indicated	11	41	17	17
67	010D	Reading the Contents of Non-Consecutive Holding Registers	10	248	10	248
	010E	Writing to Non-Consecutive Holding Registers	14	250	8	8

■ Communications Data

Communications data is a series of data that uses the combination of the communications register number and the data for these registers. The data length changes when the description of the command changes. For a loopback test, it switches to test code.

The communications register for the drive has a 2-byte length. Data that is written to the register for the drive is usually 2 bytes. Register data that is read from the drive is also 2 bytes.

■ Error Check

Error check uses the CRC-16 method to detect transmission errors. Use the procedure in this section to calculate CRC-16.

Command Data

When the drive receives data, it will make sure that there are no errors in the data. The drive uses the procedure below to calculate CRC-16, then the drive compares that data with the CRC-16 value in the message. If the CRC-16 values do not agree, the drive will not execute a command message.

When you calculate CRC-16 in MEMOBUS/Modbus communications, make sure that you set the start value as FFFF (Hex.). All 16 bits must be 1.

Use this procedure to calculate CRC-16:

1. Make sure that the start value is FFFF (Hex.).
2. Calculate the FFFF (Hex.) start value and the XOR of the slave address (exclusive OR).
3. Move the step 2 results one column to the right. Do this shift until the carry bit is 1.
4. When the carry bit is 1, calculate XOR via the result from the above step 3 and A001 (Hex.).
5. Do steps 3 and 4 until the 8th shift to the right.
6. Use the result of step 5 to calculate the XOR and the data of the following messages (function code, register address, data). Do steps 3 to 5 until the last data, then calculate.
7. The result of the last right shift or the value of the last XOR calculation is the result for CRC-16.

[Table 6.6](#) lists examples of the CRC-16 calculation of slave address 02 (Hex.) and function code 03 (Hex.). The calculated results of CRC-16 for this section is D140 (Hex.).

Note:

The calculation example only gives information about some error checks with CRC-16. The drive will do the same error checks for the next data.

Table 6.6 CRC-16 Calculation Example

Description	Calculation	Overflow	Description	Calculation	Overflow
Initial value (FFFF (Hex.))	1111 1111 1111 1111	-	Function code 03 (Hex.)	0000 0011	-
Address 02 (Hex.)	0000 0010	-	XOR w result	1000 0001 0011 1101	-
XOR w initial value	1111 1111 1111 1101		Shift 1	0100 0000 1001 1110	1
Shift 1	0111 1111 1111 1110	1	XOR w A001 (Hex.)	1010 0000 0000 0001	-
XOR w A001 (Hex.)	1010 0000 0000 0001	-	XOR result	1110 0000 1001 1111	-
XOR result	1101 1111 1111 1111	-	Shift 2	0111 0000 0100 1111	1
Shift 2	0110 1111 1111 1111	1	XOR w A001 (Hex.)	1010 0000 0000 0001	-
XOR w A001 (Hex.)	1010 0000 0000 0001	-	XOR result	1101 0000 0100 1110	-
XOR result	1100 1111 1111 1110	-	Shift 3	0110 1000 0010 0111	0
Shift 3	0110 0111 1111 1111	0	Shift 4	0011 0100 0001 0011	1
Shift 4	0011 0011 1111 1111	1	XOR w A001 (Hex.)	1010 0000 0000 0001	-
XOR w A001 (Hex.)	1010 0000 0000 0001	-	XOR result	1001 0100 0001 0010	-
XOR result	1001 0011 1111 1110	-	Shift 5	0100 1010 0000 1001	0
Shift 5	0100 1001 1111 1111	0	Shift 6	0010 0101 0000 0100	1
Shift 6	0010 0100 1111 1111	1	XOR w A001 (Hex.)	1010 0000 0000 0001	-
XOR w A001 (Hex.)	1010 0000 0000 0001	-	XOR result	1000 0101 0000 0101	-
XOR result	1000 0100 1111 1110	-	Shift 7	0100 0010 1000 0010	1
Shift 7	0100 0010 0111 1111	0	XOR w A001 (Hex.)	1010 0000 0000 0001	-
Shift 8	0010 0001 0011 1111	1	XOR result	1110 0010 1000 0011	-
XOR w A001 (Hex.)	1010 0000 0000 0001	-	Shift 8	0111 0001 0100 0001	1
XOR result	1000 0001 0011 1110	-	XOR w A001 (Hex.)	1010 0000 0000 0001	-
Perform operations with next data (function code)			XOR result	1101 0001 0100 0000	-
				1101 0001 0100 0000	-
			CRC-16	D 1 4 0 (Lower) (Upper)	-
			Continue from here with next data.		

Response Data

The drive does the CRC-16 calculation for the response message and makes sure that the data does not have errors. Make sure that the calculated value is the same value as the CRC-16 in the response message.

◆ Examples of Messages for Commands/Responses

The items in this section are examples of messages for commands/responses.

■ Read Multiple Holding Registers

Uses function code 03 (Hex.) to read the contents of a maximum of 16 holding registers.

Table 6.7 shows example messages when the drive reads status signal from the drive of slave 2, the error contents, fault contents, and frequency references.

Table 6.7 Message Example When Reading the Contents of Holding Register

Byte	Command Message	Setting Data (Hex.)	Response Message (Normal)	Setting Data (Hex.)	Response Message (Fault)	Setting Data (Hex.)
0	Slave address	02	Slave address	02	Slave address	02
1	Function code	03	Function code	03	Function code	83

Byte	Command Message		Setting Data (Hex.)	Response Message (Normal)		Setting Data (Hex.)	Response Message (Fault)		Setting Data (Hex.)
2	Starting No.	Upper	00	Data Qty		08	Error code		03
3		Lower	20	First storage register	Upper	00	CRC-16	Upper	F1
4	Data Qty	Upper	00		Next storage register	Lower		65	Lower
5		Lower	04	Next storage register		Upper	00	-	
6	CRC-16	Upper	45		Next storage register	Lower	00	-	
7		Lower	F0	Next storage register		Upper	00	-	
8	-				Next storage register	Lower	00	-	
9	-			Next storage register		Upper	01	-	
10	-				CRC-16	Lower	F4	-	
11	-			CRC-16		Upper	AF	-	
12	-				Lower	82	-		

■ Loopback Test

The loopback test uses function code 08 (Hex.) and returns the command message as a response message. This test checks communication between the master and slave. The test code and data can use desired values.

Table 6.8 shows examples of messages given out when the loopback test is done with the drive of slave 1.

Table 6.8 Message Examples from the Loopback Test

Byte	Command Message		Setting Data (Hex.)	Response Message (Normal)		Setting Data (Hex.)
0	Slave address		01	Slave address		01
1	Function code		08	Function code		08
2	Test code	Upper	00	Test code	Upper	00
3		Lower	00		Lower	00
4	Data	Upper	A5	Data	Upper	A5
5		Lower	37		Lower	37
6	CRC-16	Upper	DA	CRC-16	Upper	DA
7		Lower	8D		Lower	8D

■ Writing to Multiple Holding Registers

You can write the data that you set to the number of holding registers set in function code 10 (hex). You must configure the number of the holding registers and each 8 higher bits and 8 lower bits in order in the command message for the write data. You can write to a maximum of 16 holding registers.

Table 6.9 shows example messages when you use the PLC to set Forward run in the drive of slave 1 with a 60.00 Hz frequency reference.

When you rewrite the parameter value with the write command through the H5-11 [Comm ENTER Command Mode] setting, you must use the Enter command to save and enable the contents of the changes. Refer to H5-11: Comm ENTER Command Mode on page 901 and Enter Command on page 309 for more information.

Table 6.9 Message Example When Writing to Multiple Holding Registers

Byte	Command Message		Setting Data (Hex.)	Response Message (When Normal)		Setting Data (Hex.)	Response Message (When There is a Fault)		Setting Data (Hex.)
0	Slave address		01	Slave address		01	Slave address		01
1	Function code		10	Function code		10	Function code		90
2	Starting No.	Upper	00	Starting No.	Upper	00	Error code		02
3		Lower	01		Lower	01	CRC-16	Upper	CD
4	Data Quantity	Upper	00	Data Quantity	Upper	00		Lower	C1
5		Lower	02		Lower	02	-		
6	Byte No.		04	CRC-16	Upper	10	-		
7	First data	Upper	00		Lower	08	-		
8	Data Quantity	Lower	01	-		-			

Byte	Command Message		Setting Data (Hex.)	Response Message (When Normal)	Setting Data (Hex.)	Response Message (When There is a Fault)	Setting Data (Hex.)
9	Next data	Upper	17	-		-	
10		Lower	70	-		-	
11	CRC-16	Upper	6D	-		-	
12		Lower	B7	-		-	

Note:

The number of bytes set in the command message set the data quantity $\times 2$ during the command message. The response message uses the same formula.

■ Reading from More than One Holding Register/Reading the Indicated Register

The drive uses function code 5A (Hex.) to write to more than one register, then it reads the contents of four holding registers at the same time.

The function for writing to more than one register is the same as the function for function code 10 (Hex.). You can write to a maximum of 16 holding registers.

The four holding registers to be read from are specified in *H5-25 to H5-28 [Function 5A Register x Selection]*.

Table 6.10 shows example messages when you write to more than one holding register or when you read more than one command register. Table 6.10 uses this register data for the examples:

- The drive for slave 1 is set for Forward run with a frequency reference of 60.00 Hz.
- The setting in *H5-25 to H5-28* and the data in the specified holding registers are as follows.
 - *H5-25* = 0044H: *U1-05 [Motor Speed]* = 60.00 Hz (6000 = 1770H)
 - *H5-26* = 0045H: *U1-06 [Output Voltage Ref]* = 200.0 V (2000 = 07D0H)
 - *H5-27* = 0042H: *U1-03 [Output Current]* = 50% of drive rated current (100% = 8192, 50% = 4096 = 1000H)
 - *H5-28* = 0049H: *U1-10 [Input Terminal Status]* = 00H

When you rewrite the parameter value with the write command through the *H5-11 [Comm ENTER Command Mode]* setting, you must use the Enter command to save and enable the contents of the changes. Refer to *H5-11: Comm ENTER Command Mode on page 901* and *Enter Command on page 309* for more information.

Table 6.10 Message Example When Reading from More than One Holding Register/Reading the Indicated Register

Byte	Command Message			Response Message (when normal)			Response Message (when there is a fault)		
			Setting Data (Hex.)			Setting Data (Hex.)			Setting Data (Hex.)
0	Slave address		01	Slave address		01	Slave address		01
1	Function Code		5A	Function Code		5A	Function Code		DA
2	Starting No.	Upper	00	Register status		0F	Register status		0F
3		Lower	01	Data in holding register 1 selected with <i>H5-25</i>	Upper	17	Data in holding register 1 selected with <i>H5-25</i>	Upper	17
4	Data Qty	Upper	00	Data in holding register 2 selected with <i>H5-26</i>	Lower	70	Data in holding register 2 selected with <i>H5-26</i>	Lower	70
5		Lower	02		Upper	07		Upper	07
6	Byte No.		04	Lower	D0	Lower	D0	D0	
7	First data	Upper	00	Data in holding register 3 selected with <i>H5-27</i>	Upper	10	Data in holding register 3 selected with <i>H5-27</i>	Upper	10
8		Lower	01	Lower	00	Lower	00		
9	Next data	Upper	17	Data in holding register 4 selected with <i>H5-28</i>	Upper	00	Data in holding register 4 selected with <i>H5-28</i>	Upper	00
10		Lower	70	Lower	00	Lower	00		
11	CRC-16	Upper	4F	Starting No.	Upper	00	Error Codes		02
12		Lower	43		Lower	01	CRC-16	Upper	E9
13	-		Data Qty	Upper	00	Lower		6C	
14	-			Lower	02	-			
15	-		CRC-16	Upper	AC	-			
16	-			Lower	D0	-			

Note:

The number of bytes set in the command message set the data quantity $\times 2$ during the command message.

Register status	
bit 0	Data in register 1 selected with <i>H5-25</i> 1: Successfully read the register 0: Register read error
bit 1	Data in register 2 selected with <i>H5-26</i> 1: Successfully read the register 0: Register read error
bit 2	Data in register 3 selected with <i>H5-27</i> 1: Successfully read the register 0: Register read error
bit 3	Data in register 4 selected with <i>H5-28</i> 1: Successfully read the register 0: Register read error
bit 4	Not used
bit 5	Not used
bit 6	Not used
bit 7	Not used

■ Reading the Contents of Non-Consecutive Holding Registers

The drive uses function code 67 (Hex.) and subfunction code 010D (Hex.) to read data with a maximum of 120 holding registers.

You must give the holding register number from which to read separately.

Table 6.11 shows example messages when you read the frequency reference and torque limit from the drive for slave 1. Table 6.11 uses these specified holding registers data for the examples.

- 0024H:U1-01 [*Frequency Reference*] = 60.00 Hz (6000 = 1770H)
- 0028H:U1-09 [*Torque Reference*] = 100.0% (1000 = 03E8H)

Table 6.11 Message Example When Reading the Contents of Non-Consecutive Holding Registers

Byte	Command Message			Response Message (when normal)			Response Message (when there is a fault)		
			Setting Data (Hex.)			Setting Data (Hex.)			Setting Data (Hex.)
0	Slave address		01	Slave address		01	Slave address		01
1	Function Code		67	Function Code		67	Function Code		E7
2	Subfunction Code	Upper	01	Subfunction Code	Upper	01	Error Codes		02
3		Lower	0D		Lower	0D	CRC-16	Upper	EA
4	Data Qty	Upper	00	Byte No.	Upper	00		Lower	31
5		Lower	02		Lower	04	-	-	
6	Holding register 1 No.	Upper	00	Holding register 1 data	Upper	17	-		
7		Lower	24		Lower	70	-		
8	Holding register 2 No.	Upper	00	Holding register 2 data	Upper	03	-		
9		Lower	28		Lower	E8	-		
10	CRC-16	Upper	8B	CRC-16	Upper	47	-		
11		Lower	29		Lower	ED	-		

Note:

The number of bytes set within the response message sets twice the number of data contained in the command message.

■ Writing to Non-Consecutive Holding Registers

The drive uses function code 67 (Hex.) and subfunction code 010E (Hex.) to read data with a maximum of 60 holding registers.

You must give the holding register number from which to write separately.

Table 6.12 shows example messages when you write the frequency reference and torque limit from the drive for slave 1. Table 6.12 uses these specified holding registers data for the examples.

- 0002H: Frequency Reference = 60.00 Hz (6000 = 1770H)
- 0004H: Torque Limit = 150.0% (1500 = 05DCH)

When you rewrite the parameter value with the write command through the *H5-11 [Comm ENTER Command Mode]* setting, you must use the Enter command to save and enable the contents of the changes. Refer to *H5-11: Comm ENTER Command Mode on page 901* and *Enter Command on page 309* for more information.

Table 6.12 Message Example When Writing to Non-Consecutive Holding Registers

Byte	Command Message			Response Message (when normal)			Response Message (when there is a fault)		
			Setting Data (Hex.)			Setting Data (Hex.)			Setting Data (Hex.)
0	Slave address		01	Slave address		01	Slave address		01
1	Function Code			Function Code			Function Code		
2	Subfunction Code	Upper	01	Subfunction Code	Upper	01	Error Codes		02
3		Lower	0E		Lower	0E	CRC-16	Upper	EA
4	Data Qty	Upper	00	Data Qty	Upper	00		Lower	31
5		Lower	02		Lower	02	-		
6	Byte No.	Upper	00	CRC-16	Upper	D5	-		
7		Lower	04		Lower	FC	-		
8	Holding register 1 No.	Upper	00	-			-		
9		Lower	02	-			-		
10	Holding register 1 data	Upper	17	-			-		
11		Lower	70	-			-		
12	Holding register 2 No.	Upper	00	-			-		
13		Lower	04	-			-		
14	Holding register 2 data	Upper	05	-			-		
15		Lower	DC	-			-		
16	CRC-16	Upper	55	-			-		
17		Lower	59	-			-		

Note:

The number of bytes set in the command message set the data quantity $\times 2$ during the command message.

◆ Enter Command

When you use MEMOBUS/Modbus communications to write parameters from the PLC to the drive, *H5-11 [Comm ENTER Command Mode]* lets you use the Enter command to enable these parameters. This section gives information about the Enter command.

■ Types of Enter Commands

The drive supports the two Enter commands shown in Table 6.13.

Write 0 to register number 0900 or 0910 (Hex.) to enable the Enter command. You can only write to these registers. If you read to these registers, it will cause an error.

Table 6.13 Types of Enter Commands

Register No. (Hex.)	Description
0900	When you write parameter data to the EEPROM, you will enable the data on the RAM at the same time. This process saves the parameter changes even if you de-energize the drive.
0910	This updates the data on the RAM, but does not write data to the EEPROM. If you de-energize the drive, you will lose the parameter changes.

Note:

- You can write the EEPROM to the drive a maximum of 100,000 times. Do not frequently execute the Enter command (0900 (Hex.)) that is written to EEPROM.
- The Enter command register is write-only. If this register is read, it will cause a Register Number Error (02 (Hex.)).
- When the command data or broadcast message is transmitted to the drive, the Enter command is not necessary.

■ **Functions of the Enter Command when Replacing a Previous Generation Drive**

When you replace a previous generation Yaskawa drive with this product, you must set the Enter command function for this product the same as the previous product. The Enter command function is different for Yaskawa G7, F7-series, and V7-series drives.

Use *H5-11* to set the Enter command function:

- When replacing G7 and F7 series drives, set *H5-11* = 0 [*ENTER Command Required*].
- When replacing V7 series drives, set *H5-11* = 1 [*ENTER Command Not Required*].
- When replacing 1000-series drives, set *H5-11* to the same value as the drive you replaced.

Table 6.14 Enter Command Function Differences

H5-11 Settings	H5-11 = 0	H5-11 = 1
The drive you replaced	G7, F7	V7
Time when the parameter settings are enabled	When the drive receives the Enter command from the master	When you change the parameter settings
Upper and lower limit check	Checks the upper and lower limits and considers the related parameter settings.	Checks the upper and lower limit of the changed parameter only.
Default setting of related parameters	Will not change related parameter settings. You must change the parameters manually.	Automatically changes the default settings for the related parameters.
Fault detection when you set more than one parameter	Accepts and responds as usual to correct setting data if the data contains parameter setting errors. The drive discards the disabled setting data, but will not return an error message.	If there is a setting error in a parameter, the drive responds with a fault. The drive discards the data that was sent.

◆ **Self-Diagnostics**

The drive can use Self-Diagnostics to find the operation of the serial communications interface circuit. Self-Diagnostics connects the transmission terminal to the reception terminal on the control circuit. It then transmits the data sent by the drive and makes sure that the drive can communicate correctly.

Use this procedure to do Self-Diagnostics:

1. Energize the drive.
2. Set *H1-06* = 67 [*Terminal S6 Function Select = Communications test mode*].
3. De-energize the drive.
4. Connect a jumper between control circuit terminals S6 and SN.
Make sure terminal SC and terminal SP are connected by a wire jumper.

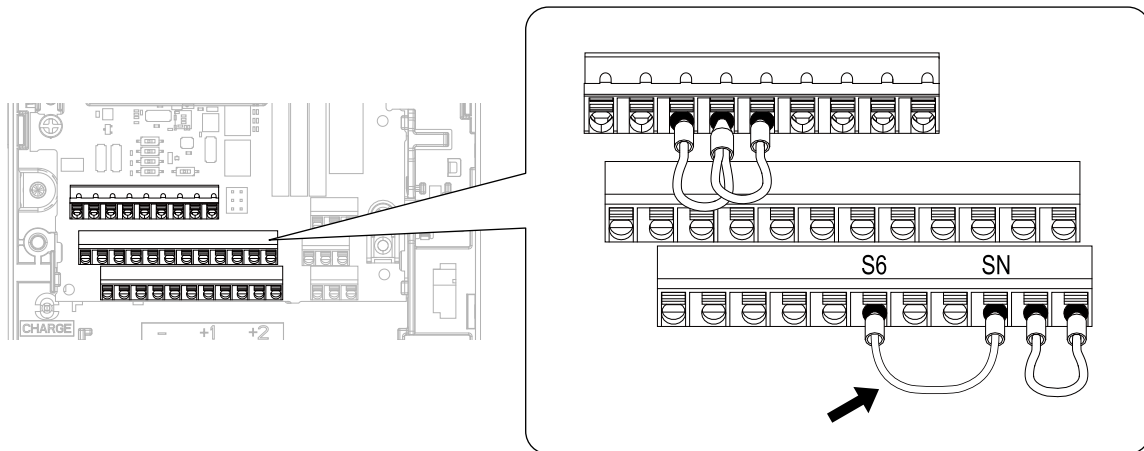

Figure 6.8 Self-Diagnostics Jumper Terminals

5. Energize the drive.
6. When normal, the keypad will show *PASS* [*MEMOBUS/Modbus Communications Test Mode Normal*].
When there is an error, the keypad will show *CE* [*MEMOBUS/Modbus Communications Error*].

7. De-energize the drive.
8. Disconnect the wire jumper between terminals S6 and SN. Set terminal S6 to its initial function.

Self-Diagnostics is complete and the drive returns to its usual function.

◆ Communications Data Table

Command Data on page 311, *Monitor Data on page 314*, and *Broadcast Messages on page 327* show the communications data. The data types are command data, monitor data, and broadcast message.

Refer to the Parameter List for parameter communications registers.

■ Command Data

You can read and write command data.

Note:

Set the reserved bit to 0. Do not write the data in the reserved register or the monitor register.

Table 6.15 MEMOBUS/Modbus Communications Command Data

Register No. (Hex.)	Description	
0000	Reserved	
0001	Run command, multi-function input command	
	bit 0	When $H5-12 = 0$, Forward run/stop 1: Forward run, 0: Stop When $H5-12 = 1$, run/stop 1: Run, 0: Stop
	bit 1	When $H5-12 = 0$, Reverse run/stop 1: Reverse run, 0: Stop When $H5-12 = 1$, Forward/Reverse run 1: Reverse, 0: Forward run
	bit 2	External Fault 1: $EF0$ [Option Card External Fault]
	bit 3	Fault Reset 1: Reset command
	bit 4	Multi-function input 1 When $H1-01 = 40$ [Forward Run Command (2-Wire Seq)], the multi-function input command is "ComRef." Note: When you switch the bit ON as ComRef, the frequency reference source changes to MEMOBUS/Modbus communications. When you connect a communication option to the drive, the frequency reference source gives priority to the communications option.
	bit 5	Multi-function input 2 When the multi-function input command is $H1-02 = 41$ [Reverse Run Command (2-Wire Seq)], bit 5 is "ComCtrl." Note: When you switch the bit ON as ComCtrl, the Run Command source changes to MEMOBUS/Modbus communications. When you connect a communication option to the drive, the Run Command source gives priority to the communications option.
	bit 6	Multi-function input 3
	bit 7	Multi-function input 4
	bit 8	Multi-function input 5
	bit 9	Multi-function input 6
	bit A	Multi-function input 7
	bit B	Multi-function input 8
	bit C - F	Reserved
0002	Frequency Reference	$o1-03$ [Frequency Display Unit Selection] (unsigned) sets the units.
0003	Output voltage gain	Units: 0.1% Setting range: 20 (2.0%) to 2000 (200.0%), the default value at energize: 1000 (100.0%)
0004	Torque reference/torque limit (0.1% signed)	
0005	Torque compensation (0.1% signed)	
0006	PID setpoint (0.01% signed)	
0007	Setting for the multi-function analog monitor output terminal 1 (10 V/4000 H)	

6.3 MEMOBUS/Modbus Communications

Register No. (Hex.)	Description	
0008	Setting for the multi-function analog monitor output terminal 2 (10 V/4000 H)	
0009	MFDO setting	
	bit 0	MFDO (terminal M1-M2) 1: ON, 0: OFF
	bit 1	MFDO (terminal M3-M4) 1: ON, 0: OFF
	bit 2	MFDO (terminal M5-M6) 1: ON, 0: OFF
	bit 3 - 5	Reserved
	bit 6	1: bit 7 function is enabled
	bit 7	Fault relay output (terminal MA/MB-MC) 1: ON, 0: OFF
	bit 8 - F	Reserved
000A	Pulse train output (Units: 1/1 Hz, setting range: 0 to 32000)	
000B - 000E	Reserved	
000F	Command selection setting	
	bit 0	Reserved
	bit 1	Input for the PID setpoint 1: Enables target values from MEMOBUS/Modbus
	bit 2	Torque reference/torque limit input 1: Enables setting values from MEMOBUS/Modbus
	bit 3	Torque Compensation Input 1: Enables setting values from MEMOBUS/Modbus
	bit 4	Reserved
	bit 5	PID feedback from the MEMOBUS/Modbus 1: Enables PID feedback (15FF (Hex.) from MEMOBUS/Modbus
	bit 6 - B	Reserved
	bit C	Terminal S5 input of broadcast message 1: Enabled, 0: Disabled
	bit D	Terminal S6 input of broadcast message 1: Enabled, 0: Disabled
	bit E	Terminal S7 input of broadcast message 1: Enabled, 0: Disabled
	bit F	Terminal S8 input of broadcast message 1: Enabled, 0: Disabled
0010 - 001A	Reserved	
001B	Analog monitor option AO-A3 analog output 1 value (10 V/4000 (Hex.))	
001C	Analog monitor option AO-A3 analog output 2 value (10 V/4000 (Hex.))	
001D	Digital output option DO-A3 output value (binary)	
001E - 001F	Reserved	
15C0	bit 0	Extended multi-function input command 1
	bit 1	Extended multi-function input command 2
	bit 2	Extended multi-function input command 3
	bit 3 - F	Reserved

Register No. (Hex.)	Description	
15DF	bit 0	Speed Search from Fmax 1: Enables Speed Search from Fmax • This is the same function as $H1-xx = 61$ [MFDI Function Selection = Speed Search from Fmax]. It operates as specified by the command and OR operation from the MFDI terminals.
	bit 1	Baseblock command 1: Enables baseblock command • This is the same function as $H1-xx = 8$ [Baseblock Command (N.O.)]. It operates as specified by the command and OR operation from the MFDI terminals.
	bit 2	Baseblock command - Without message 1: Enables baseblock command • This is the same function as $H1-xx = 8$ [Baseblock Command (N.O.)]. • The keypad does not show the <i>bb</i> [Baseblock] alarm message. The ALM LED does not flash.
	bit 3	Coast-to-stop command 1: Enables coast-to-stop command • The drive shuts off the output and the motor coasts to stop at the leading edge of bit 3. • To restart the drive, set bit 3 to 0 and enter the Run command again.
	bit 4	Ramp to stop command 1: Enables ramp to stop command • The drive ramps to stop in the selected deceleration time at the leading edge of bit 4. • To restart the drive, set bit 4 to 0 and enter the Run command again.
	bit 5	Fast stop command 1: Enables fast stop command • This is the same function as $H1-xx = 15$ [Fast Stop (N.O.)]. It operates as specified by the command and OR operation from the MFDI terminals.
	bit 6	Soft start input reset 1: Enables soft start input reset • When bit 6 is 1, the input to the soft starter will be 0. The drive decelerates the motor in the selected deceleration time. When bit 6 is 0, the motor accelerates to the previous frequency reference. • $U1-01$ [Frequency Reference] shows the set frequency reference.
	bit 7	Soft start output reset 1: Enables soft start output reset • When bit 7 is 1, the output from the soft starter will be 0. • When $A1-02 = 3, 7$ [Control Method Selection = CLV or CLV/PM], the drive decelerates the motor as specified by the torque limit. When $A1-02 \neq 3, 7$ the drive shuts off the output and the motor coasts. • When bit 6 is 0, the motor accelerates to the previous frequency reference.
	bit 8	Accel/decel ramp hold command 1: Enables accel/decel ramp hold command • This is the same function as $H1-xx = A$ [Accel/Decel Ramp Hold]. It operates as specified by the command and OR operation from the MFDI terminals.
	bit 9	JOG command 1: Enables JOG command • This is the same function as $H1-xx = 6$ [Jog Reference Selection]. It operates as specified by the command and OR operation from the MFDI terminals.
	bit A	Forward Jog 1: Enables FJOG command • This is the same function as $H1-xx = 12$ [Forward Jog]. It operates as specified by the command and OR operation from the MFDI terminals.
	bit B	Reverse Jog 1: Enables RJOG command • This is the same function as $H1-xx = 13$ [Reverse Jog]. It operates as specified by the command and OR operation from the MFDI terminals.
	bit C	PID Disable command 1: Enables PID Disable command • This the same function as $H1-xx = 19$ [PID Disable]. It operates as specified by the command and OR operation from the MFDI terminals.
bit D - F	Reserved	
15E0	bit 1	Mbus Reg 15E0h bit0 Output Func When you do not set functions to $H2-40$ to $H2-42$, set them to <i>F</i> [Not Used].
	bit 2	Mbus Reg 15E0h bit1 Output Func When you do not set functions to $H2-40$ to $H2-42$, set them to <i>F</i> [Not Used].
	bit 3	Mbus Reg 15E0h bit2 Output Func When you do not set functions to $H2-40$ to $H2-42$, set them to <i>F</i> [Not Used].

6.3 MEMOBUS/Modbus Communications

Register No. (Hex.)	Description
3004	<p>Time Setting Setting range: 0000 to 2359 (decimal), the default value at energize: 0000 Set the hour and the minute in HHMM format.</p> <ul style="list-style-type: none">• HH: 00 to 23 (decimal)• MM: 00 to 59 (decimal)
3005	<p>Year and Day Setting Setting range: 1600 to 9906 (decimal), the default value at energize: 1600 Sets the year and the day of the week in YYDW format.</p> <ul style="list-style-type: none">• YY: the last two digits of the year from 16 to 99 (decimal)• DW: the day of the week<ul style="list-style-type: none">– Sunday: 00– Monday: 01– Tuesday: 02– Wednesday: 03– Thursday: 04– Friday: 05– Saturday: 06
3006	<p>Date Setting Setting range: 101 to 1231 (decimal), the default value at energize: 101 Sets the month and the date in MMDD format.</p> <ul style="list-style-type: none">• MM: 01 to 12 (decimal)• DD: 01 to 31 (decimal)
3007	<p>Set the Date Information Setting range: 0 to 8 (decimal), the default value at energize: 8 Sets the values specified in 3004H to 3006H as the date and time.</p> <ul style="list-style-type: none">• Command Data: 1• Response Data: 0 (normal), 8 (fault)

■ Monitor Data

You can only read monitor data.

Table 6.16 Monitor Data for MEMOBUS/Modbus Communication

Register No. (Hex.)	Description	
0020	Drive Status 1	
	bit 0	During Run 1: During run, 0: During stop
	bit 1	During Reverse 1: During reverse, 0: Forward run
	bit 2	Drive ready 1: Ready, 0: Not ready
	bit 3	Fault 1: Fault
	bit 4	Data Setting Error 1: oPExx error
	bit 5	MFDO (terminal M1-M2) 1: ON, 0: OFF
	bit 6	MFDO (terminal M3-M4) 1: ON, 0: OFF
	bit 7	MFDO (terminal M5-M6) 1: ON, 0: OFF
	bit 8 - B	Reserved
	bit C	SToF [Safe Torque OFF Hardware] 1: One of Safe Disable input 1 (terminal H1-HC) and Safe Disable input 2 (terminal H2-HC) is OFF (open) and the other is ON (closed)
	bit D	STo [Safe Torque OFF] 1: Both Safe Disable input 1 (terminal H1-HC) and Safe Disable input 2 (terminal H2-HC) are OFF (open)
	bit E	ComRef status 1: Enabled
	bit F	ComCtrl status 1: Enabled
0021	Fault Description 1	
	bit 0	oC [Overcurrent], GF [Ground Fault]
	bit 1	ov [Overvoltage]
	bit 2	oL2 [Drive Overload]
	bit 3	oH1 [Heatsink Overheat], oH2 [External Overheat (H1-XX=B)]
	bit 4	rH [Braking Resistor Overheat], rr [Dynamic Braking Transistor Fault]
	bit 5	Reserved
	bit 6	FbL [PID Feedback Loss], FbH [Excessive PID Feedback]
	bit 7	EF0 [Option Card External Fault], EF1 to EF8 [External Fault]
	bit 8	CPFxx [Hardware Fault] Note: Includes oFx.
	bit 9	oL1 [Motor Overload], oL3, oL4 [Overtorque Detection 1/2], UL3, UL4 [Undertorque Detection 1/2]
	bit A	PGo [Encoder (PG) Feedback Loss], PGoH [Encoder (PG) Hardware Fault], oS [Overspeed], dEv [Speed Deviation]
	bit B	During Uv [Undervoltage] detection
	bit C	Uv1 [DC Bus Undervoltage], Uv2 [Control Power Undervoltage], Uv3 [Soft Charge Answerback Fault]
	bit D	LF [Output Phase Loss], PF [Input Phase Loss]
	bit E	CE [Modbus Communication Error], bUS [Option Communication Error]
bit F	oPr [Keypad Connection Fault]	

6.3 MEMOBUS/Modbus Communications

Register No. (Hex.)	Description	
0022	Fault Contents	
	bit 0	1: During data writing, during motor switching
	bit 1	Reserved
	bit 2	
	bit 3	1: Upper/Lower Limit Fault
	bit 4	1: Data Integrity Fault
	bit 5	1: During EEPROM writing
	bit 6	0: EEPROM writing 1: Change data only on the RAM Note: Enabled when H5-17 = 1 [ENTER Command Response @CPU BUSY = Write to RAM Only].
bit 7 - F	Reserved	
0023	U1-01 [Frequency Reference] Note: o1-03 [Frequency Display Unit Selection] sets the units.	
0024	U1-02 [Output Frequency] Note: o1-03 [Frequency Display Unit Selection] sets the units.	
0025	U1-06 [Output Voltage Ref] (units: 0.1 V) Note: Use H5-10 [Modbus Register 0025H Unit Sel] to change the setting unit.	
0026	U1-03 [Output Current] (units: 0.1 A)	
0027	U1-08 [Output Power]	
0028	U1-09 [Torque Reference]	
0029	Fault Description 2	
	bit 0	Reserved
	bit 1	GF [Ground Fault]
	bit 2	PF [Input Phase Loss]
	bit 3	LF [Output Phase Loss]
	bit 4	rH [Braking Resistor Overheat]
	bit 5	Reserved
	bit 6	oH4 [Motor Overheat Fault (PTC Input)]
bit 7 - F	Reserved	
002A	Minor Fault Description 1	
	bit 0 - 1	Reserved
	bit 2	EF [FWD/REV Run Command Input Error]
	bit 3	bb [Baseblock]
	bit 4	oL3 [Overtorque 1]
	bit 5	oH [Heatsink Overheat]
	bit 6	ov [Overvoltage]
	bit 7	Uv [Undervoltage]
	bit 8	FAn [Internal Fan Fault]
	bit 9	CE [Modbus Communication Error]
	bit A	bUS [Option Communication Error]
	bit B	UL3/UL4 [Undertorque Detection 1/2]
	bit C	oH3 [Motor Overheat (PTC Input)]
	bit D	FbL [PID Feedback Loss], FbH [Excessive PID Feedback]
	bit E	Reserved
bit F	CALL [Serial Comm Transmission Error]	

Register No. (Hex.)	Description	
002B	U1-10 [Input Terminal Status]	
	bit 0	1: Control circuit terminal S1 ON
	bit 1	1: Control circuit terminal S2 ON
	bit 2	1: Control circuit terminal S3 ON
	bit 3	1: Control circuit terminal S4 ON
	bit 4	1: Control circuit terminal S5 ON
	bit 5	1: Control circuit terminal S6 ON
	bit 6	1: Control circuit terminal S7 ON
	bit 7	1: Control circuit terminal S8 ON
bit 8 - F	Reserved	
002C	Drive Status 2	
	bit 0	During Run 1: During Run
	bit 1	During zero speed 1: During zero speed
	bit 2	Speed agreement 1: During agreement
	bit 3	User-defined speed agreement 1: During agreement
	bit 4	Frequency Detection 1 1: Output frequency \leq L4-01
	bit 5	Frequency Detection 2 1: Output frequency \geq L4-01
	bit 6	Drive ready 1: Run ready
	bit 7	During low voltage detection 1: During detection
	bit 8	During Baseblock 1: Drive output during baseblock
	bit 9	Frequency reference mode 1: No communication option, 0: Communication option
	bit A	Run command mode 1: No communication option, 0: Communication option
	bit B	During overtorque/undertorque 1, 2 detection
	bit C	Frequency reference loss 1: Loss
	bit D	Executing Auto-Restart 1: Restart Enabled
	bit E	Fault 1: Fault generated
bit F	MEMOBUS/Modbus communications timeout 1: At Timeout	
002D	U1-11 [Output Terminal Status]	
	bit 0	MFDO (terminal M1-M2) 1: ON, 0: OFF
	bit 1	MFDO (terminal M3-M4) 1: ON, 0: OFF
	bit 2	MFDO (terminal M5-M6) 1: ON, 0: OFF
	bit 3 - 6	Reserved
	bit 7	Fault relay output (terminal MA/MB-MC) 1: ON, 0: OFF
	bit 8 - F	Reserved
002E	Reserved	

6.3 MEMOBUS/Modbus Communications

Register No. (Hex.)	Description	
002F	Frequency reference bias (Up 2/Down 2 function) (Units: 0.1%)	
0030	Reserved	
0031	U1-07 [DC Bus Voltage] (unit: 1 V)	
0032	U1-09 [Torque Reference] (unit: 1%)	
0033	Reserved	
0034	Product code 1 [ASCII], product type (GA700 = 0A)	
0035	Product code 2 [ASCII], specification (GA700 = 70)	
0036 - 0037	Reserved	
0038	PID Feedback: Unsigned, input is equivalent to 100%/maximum output frequency (Units: 0.1%)	
0039	PID Input: Signed, $\pm 100\%$ / \pm maximum output frequency (Units: 0.1%)	
003A	PID Output: Signed, $\pm 100\%$ / \pm maximum output frequency (Units: 0.1%)	
003B - 003C	Reserved	
003D	Communications error description Note: The drive saves the description of the communications error until you reset the fault.	
	bit 0	CRC Error
	bit 1	Data Length Error
	bit 2	Reserved
	bit 3	Parity Error
	bit 4	Overrun Error
	bit 5	Framing Error
	bit 6	Timeout
bit 7 - F	Reserved	
003E	Output frequency Units: min^{-1} or r/min Note: Set E2-04, E4-04, E5-04, E9-08 [Motor Pole Count].	
003F	0.01% units	
0040 - 004A	Used with U1-xx [Operation Status Monitors]. Refer to the U Monitor for parameter details.	
004B	U1-12 [Drive Status]	
	bit 0	1: During Run
	bit 1	1: During zero speed
	bit 2	1: During reverse
	bit 3	1: During reset signal input
	bit 4	1: During speed agreement
	bit 5	1: Drive operation ready
	bit 6	1: Minor Fault
	bit 7	1: Fault
	bit 8	1: oPExx [Operation Error] generation
	bit 9	1: Recovery from momentary power loss, 0: Power recovery
	bit A	1: Motor 2 Selection
	bit B	Reserved
	bit E	ComRef status/ NetRef status
bit F	ComCtrl status/ NetCtrl status	
004C - 007E	Use with U1-xx, U4-xx, U5-xx, U6-xx [Monitors]. Refer to "U2: Fault Trace" and "U3: Fault History" for more information.	
007F	Minor fault code (Refer to "Minor fault description" for more information about the minor fault codes.)	
0080 - 0097	Use with U2-xx, U3-xx [Monitors]. Refer to "U Monitor" for more information, and refer to "Fault Trace/Fault History Descriptions" for more information about register values.	

Register No. (Hex.)	Description	
0098 - 0099	U4-01 [Cumulative Ope Time] Example: When U4-01 [Cumulative Ope Time = 12345], 0098 (Hex.) = 1234 and 0099 (Hex.) = 5.	
009A - 009B	U4-03 [Cooling Fan Ope Time] Example: When U4-03 [Cooling Fan Ope Time = 12345], 009A (Hex.) = 1234 and 009B (Hex.) = 5.	
009C - 00AA	Reserved	
00AB	Drive rated current Note: The unit of display is different for different models. 2004 to 2042, 4002 to 4023: 0.01 A 2056 to 2415, 4031 to 4H12: 0.1 A	
00AC	U1-05 [Motor Speed]	Units: min ⁻¹ or r/min Note: Set E2-04, E4-04, E5-04, E9-08 [Motor Pole Count].
00AD		Units: 0.01%
00AE, 00AF	Reserved	
00B0	Option codes connected to CN5-A	The drive stores option codes in the register. AI-A3 = 0003 (Hex.) AO-A3 = 0004 (Hex.) DI-A3 = 0001 (Hex.) DO-A3 = 0002 (Hex.) PG-B3 = 0011 (Hex.) PG-F3 = 0021 (Hex.) PG-RT3 = 0023 (Hex.) PG-X3 = 0012 (Hex.) SI-C3 = 5343 (Hex.) SI-EM3 = 1005 (Hex.) SI-EN3 = 1006 (Hex.) SI-ET3 = 1004 (Hex.) SI-N3 = 534E (Hex.) SI-P3 = 5350 (Hex.) SI-S3 = 5353 (Hex.) SI-T3 = 5354 (Hex.) SI-W3 = 1003 (Hex.) SI-ES3 = 1001 (Hex.) JOHB-SMP3 (EtherCAT) = 1001 (Hex.) JOHB-SMP3 (Modbus TCP/IP) = 1005 (Hex.) JOHB-SMP3 (EtherNet/IP) = 1006 (Hex.) JOHB-SMP3 (PROFINET) = 1006 (Hex.)
00B1	Reserved	
00B2	Option codes connected to CN5-B	
00B3	Option codes connected to CN5-C	
00B4	Reserved	
00B5	U1-16 [SFS Output Frequency]	Units: min ⁻¹ or r/min Note: Set E2-04, E4-04, E5-04, E9-08 [Motor Pole Count].
00B6		Units: 0.01%
00B7	Frequency reference monitor	Units: min ⁻¹ or r/min Note: Set E2-04, E4-04, E5-04, E9-08 [Motor Pole Count].
00B8		Units: 0.01%
00B9 - 00BE	Reserved	
00BF	Operation error number xx of oPExx is displayed.	

6.3 MEMOBUS/Modbus Communications

Register No. (Hex.)	Description	
00C0	Fault Description 3	
	bit 0	Reserved
	bit 1	Uv1 [DC Bus Undervoltage]
	bit 2	Uv2 [Control Power Undervoltage]
	bit 3	Uv3 [Soft Charge Answerback Fault]
	bit 4	SC [Short Circuit/IGBT Failure]
	bit 5	GF [Ground Fault]
	bit 6	oC [Overcurrent]
	bit 7	ov [Overvoltage]
	bit 8	oH [Heatsink Overheat]
	bit 9	oH1 [Heatsink Overheat]
	bit A	oL1 [Motor Overload]
	bit B	oL2 [Drive Overload]
	bit C	oL3 [Overtorque Detection 1]
	bit D	oL4 [Overtorque Detection 2]
	bit E	rr [Dynamic Braking Transistor Fault]
bit F	rH [Braking Resistor Overheat]	
00C1	Fault Description 4	
	bit 0	EF3 [External Fault (Terminal S3)]
	bit 1	EF4 [External Fault (Terminal S4)]
	bit 2	EF5 [External Fault (Terminal S5)]
	bit 3	EF6 [External Fault (Terminal S6)]
	bit 4	EF7 [External Fault (Terminal S7)]
	bit 5	EF8 [External Fault (Terminal S8)]
	bit 6	FAn [Internal Fan Fault]
	bit 7	oS [Overspeed]
	bit 8	dEv [Speed Deviation]
	bit 9	PGo [Encoder (PG) Feedback Loss]
	bit A	PF [Input Phase Loss]
	bit B	LF [Output Phase Loss]
	bit C	oH3 [Motor Overheat (PTC Input)]
	bit D	oPr [Keypad Connection Fault]
	bit E	Err [EEPROM Write Error]
bit F	oH4 [Motor Overheat Fault (PTC Input)]	

Register No. (Hex.)	Description	
00C2	Fault Description 5	
	bit 0	CE [Modbus Communication Error]
	bit 1	bUS [Option Communication Error]
	bit 2 - 3	Reserved
	bit 4	CF [Control Fault]
	bit 5	SvE [Zero Servo Fault]
	bit 6	EF0 [Option Card External Fault]
	bit 7	FbL [PID Feedback Loss]
	bit 8	UL3 [Undertorque Detection 1]
	bit 9	UL4 [Undertorque Detection 2]
	bit A	oL7 [High Slip Braking Overload]
	bit B - E	Reserved
	bit F	Hardware Fault (includes <i>oFx</i> fault)
00C3	Fault Description 6	
	bit 0	Reserved
	bit 1	dv1 [Z Pulse Fault]
	bit 2	dv2 [Z Pulse Noise Fault Detection]
	bit 3	dv3 [Inversion Detection]
	bit 4	dv4 [Inversion Prevention Detection]
	bit 5	LF2 [Output Current Imbalance]
	bit 6	STPo [Motor Step-Out Detected]
	bit 7	PGoH [Encoder (PG) Hardware Fault]
	bit 8	E5 [MECHATROLINK Watchdog Timer Err]
	bit 9	Reserved
	bit A	SEr [Speed Search Retries Exceeded]
	bit B - F	Reserved
00C4	Fault Description 7	
	bit 0	FbH [Excessive PID Feedback]
	bit 1	EF1 [External Fault (Terminal S1)]
	bit 2	EF2 [External Fault (Terminal S2)]
	bit 3	oL5 [Mechanical Weakening Detection 1]
	bit 4	UL5 [Mechanical Weakening Detection 2]
	bit 5	CoF [Current Offset Fault]
	bit 6 - 7	Reserved
	bit 8	dWFL [DriveWorksEZ Fault]
	bit 9	dWF1 [EEPROM Memory DWEZ Data Error]
	bit A - C	Reserved
	bit D	rF [Braking Resistor Fault]
	bit E	boL [Braking Transistor Overload Fault]
bit F	oH5 [Motor Overheat (NTC Input)]	

6.3 MEMOBUS/Modbus Communications

Register No. (Hex.)	Description	
00C5	Fault Description 8	
	bit 0	LSo [Low Speed Motor Step-Out]
	bit 1	nSE [Node Setup Error]
	bit 2	Tho [Thermistor Disconnect]
	bit 3- 9	Reserved
	bit A	dv7 [Polarity Judge Timeout]
	bit B - F	Reserved
00C6 - 00C7	Reserved	
00C8	Minor Fault Description 2	
	bit 0	Uv [Undervoltage]
	bit 1	ov [Overvoltage]
	bit 2	oH [Heatsink Overheat]
	bit 3	oH2 [Overheat Alarm]
	bit 4	oL3 [Overtorque 1]
	bit 5	oL4 [Overtorque 2]
	bit 6	EF [FWD/REV Run Command Input Error]
	bit 7	bb [Baseblock]
	bit 8	EF3 [External Fault (Terminal S3)]
	bit 9	EF4 [External Fault (Terminal S4)]
	bit A	EF5 [External Fault (Terminal S5)]
	bit B	EF6 [External Fault (Terminal S6)]
	bit C	EF7 [External Fault (Terminal S7)]
	bit D	EF8 [External Fault (Terminal S8)]
	bit E	FAn [Internal Fan Fault]
bit F	oS [Overspeed]	
00C9	Minor Fault Description 3	
	bit 0	dEv [Speed Deviation]
	bit 1	PGo [Encoder (PG) Feedback Loss]
	bit 2	oPr [Keypad Connection Fault]
	bit 3	CE [Modbus Communication Error]
	bit 4	bUS [Option Communication Error]
	bit 5	CALL [Serial Comm Transmission Error]
	bit 6	oL1 [Motor Overload]
	bit 7	oL2 [Drive Overload]
	bit 8	Reserved
	bit 9	EF0 [Option Card External Fault]
	bit A	rUn [Motor Switch during Run]
	bit B	Reserved
	bit C	CALL [Serial Comm Transmission Error]
	bit D	UL3 [Undertorque Detection 1]
	bit E	UL4 [Undertorque Detection 2]
bit F	SE [Modbus Test Mode Error]	

Register No. (Hex.)	Description	
00CA	Minor Fault Description 4	
	bit 0	L24v [Loss of External Power 24 Supply]
	bit 1	oH3 [Motor Overheat (PTC Input)]
	bit 2 - 5	Reserved
	bit 6	FbL [PID Feedback Loss]
	bit 7	FbH [Excessive PID Feedback]
	bit 8	Reserved
	bit 9	dnE [Drive Disabled]
	bit A	PGoH [Encoder (PG) Hardware Fault]
	bit B - F	Reserved
00CB	Minor Fault Description 5	
	bit 0	E5 [MECHATROLINK Watchdog Timer Err]
	bit 1	AEr [Station Address Setting Error]
	bit 2	CyC [MECHATROLINK CommCycleSettingErr]
	bit 3	HCA [High Current Alarm]
	bit 4	LT-1 [Cooling Fan Maintenance Time]
	bit 5	LT-2 [Capacitor Maintenance Time]
	bit 6 - 7	Reserved
	bit 8	EF1 [External Fault (Terminal S1)]
	bit 9	EF2 [External Fault (Terminal S2)]
	bit A	SToF [Safe Torque OFF Hardware]
	bit B	STo [Safe Torque OFF]
	bit C	oL5 [Mechanical Weakening Detection 1]
	bit D	UL5 [Mechanical Weakening Detection 2]
bit E - F	Reserved	
00CC	Minor Fault Description 6	
	bit 0	Reserved
	bit 1	TrPC [IGBT Maintenance Time (90%)]
	bit 2	LT-3 [SoftChargeBypassRelay MainteTime]
	bit 3	LT-4 [IGBT Maintenance Time (50%)]
	bit 4	boL [Braking Transistor Overload]
	bit 5 - 6	Reserved
	bit 7	oH5 [Motor Overheat (NTC Input)]
	bit 8	dWAL [DriveWorksEZ Fault]
	bit 9 - B	Reserved
	bit C	Tho [Thermistor Disconnect]
bit D - F	Reserved	
00CD - 00CF	Reserved	

6.3 MEMOBUS/Modbus Communications

Register No. (Hex.)	Description	
00D0	CPF Contents 1	
	bit 0 - 1	Reserved
	bit 2	CPF02 [Control Circuit Error]
	bit 3	CPF03 [Control Circuit Error]
	bit 4 - 5	Reserved
	bit 6	CPF06 [Control Circuit Error (EEPROM memory Data Error)]
	bit 7	CPF07 [Control Circuit Error]
	bit 8	CPF08 [Control Circuit Error]
	bit 9	Reserved
	bit A	CPF10 [Control Circuit Error]
	bit B	CPF11 [Control Circuit Error]
	bit C	CPF12 [Control Circuit Error]
	bit D	CPF13 [Control Circuit Error]
	bit E	CPF14 [Control Circuit Error]
	bit F	Reserved
00D1	CPF Contents 2	
	bit 0	CPF16 [Control Circuit Error]
	bit 1	CPF17 [Control Circuit Error]
	bit 2	CPF18 [Control Circuit Error]
	bit 3	CPF19 [Control Circuit Error]
	bit 4	CPF20 [Control Circuit Error]
	bit 5	CPF21 [Control Circuit Error]
	bit 6	CPF22 [Control Circuit Error]
	bit 7	CPF23 [Control Circuit Error]
	bit 8	CPF24 [Control Circuit Error (Drive Unit Signal Fault)]
	bit 9	Reserved
	bit A	CPF26 [Control Circuit Error]
	bit B	CPF27 [Control Circuit Error]
	bit C	CPF28 [Control Circuit Error]
	bit D	CPF29 [Control Circuit Error]
bit E	CPF30 [Control Circuit Error]	
bit F	CPF31 [Control Circuit Error]	
00D2	CPF Contents 3	
	bit 0	CPF32 [Control Circuit Error]
	bit 1	CPF33 [Control Circuit Error]
	bit 2	CPF34 [Control Circuit Error]
	bit 3	CPF35 [Control Circuit Error]
	bit 4	CPF36 [Control Circuit Error]
	bit 5	CPF37 [Control Circuit Error]
	bit 6	CPF38 [Control Circuit Error]
	bit 7	CPF39 [Control Circuit Error]
bit 8 - F	Reserved	
00D3 - 00D7	Reserved	

Register No. (Hex.)	Description	
00D8	oFA0x Description (CN5-A)	
	bit 0	oFA00 [Option Not Compatible with Port]
	bit 1	oFA01 [Option Fault/Connection Error]
	bit 2 - 4	Reserved
	bit 5	oFA05 [Option A/D Error]
	bit 6	oFA06 [Option Communication Error]
	bit 7 - F	Reserved
00D9	oFA1x Description (CN5-A)	
	bit 0	oFA10 [Option RAM Error]
	bit 1	oFA11 [Option Ope Mode Error]
	bit 2	oFA12 [Drive Receive CRC Error]
	bit 3	oFA13 [Drive Receive Frame Error]
	bit 4	oFA14 [Drive Receive Abort Error]
	bit 5	oFA15 [Option Receive CRC Error]
	bit 6	oFA16 [Option Receive Frame Error]
	bit 7	oFA17 [Option Receive Abort Error]
bit 8 - F	Reserved	
00DA	Reserved	
00DB	oFA3x Description (CN5-A)	
	bit 0	oFA30 [COM ID Error]
	bit 1	oFA31 [Type Code Error]
	bit 2	oFA32 [SUM Check Error]
	bit 3	oFA33 [Option Receive Time Over]
	bit 4	oFA34 [Memobus Time Over]
	bit 5	oFA35 [Drive Receive Time Over 1]
	bit 6	oFA36 [CI Check Error]
	bit 7	oFA37 [Drive Receive Time Over 2]
	bit 8	oFA38 [Control Reference Error]
	bit 9	oFA39 [Drive Receive Time Over 3]
	bit A	oFA40 [CtrlResSel 1Err]
	bit B	oFA41 [Drive Receive Time Over 4]
	bit C	oFA42 [CtrlResSel 2Err]
	bit D	oFA43 [Drive Receive Time Over 5]
bit E - F	Reserved	
00DC	oFb0x Description (CN5-B)	
	bit 0	oFb00 [Option Not Compatible with Port]
	bit 1	oFb01 [Option Fault/Connection Error]
	bit 2	oFb02 [Duplicate Options]
	bit 3 - 4	Reserved
	bit 5	oFb05 [Option A/D Error]
	bit 6	oFb06 [Option Communication Error]
bit 7 - F	Reserved	

6.3 MEMOBUS/Modbus Communications

Register No. (Hex.)	Description	
00DD	oFb1x Description (CN5-B)	
	bit 0	oFb10 [Option RAM Error]
	bit 1	oFb11 [Option Ope Mode Error]
	bit 2	oFb12 [Drive Receive CRC Error]
	bit 3	oFb13 [Drive Receive Frame Error]
	bit 4	oFb14 [Drive Receive Abort Error]
	bit 5	oFb15 [Option Receive CRC Error]
	bit 6	oFb16 [Option Receive Frame Error]
	bit 7	oFb17 [Option Receive Abort Error]
	bit 8 - F	Reserved
00DE - 00DF	Reserved	
00E0	oFb3x Description (CN5-B)	
	bit 0	oFb30 [COM ID Error]
	bit 1	oFb31 [Type Code Error]
	bit 2	oFb32 [SUM Check Error]
	bit 3	oFb33 [Option Receive Time Over]
	bit 4	oFb34 [Memobus Time Over]
	bit 5	oFb35 [Drive Receive Time Over 1]
	bit 6	oFb36 [CI Check Error]
	bit 7	oFb37 [Drive Receive Time Over 1]
	bit 8	oFb38 [Control Reference Error]
	bit 9	oFb39 [Drive Receive Time Over 1]
	bit A	oFb40 [CtrlResSel 1Err]
	bit B	oFb41 [Drive Receive Time Over 4]
	bit C	oFb42 [CtrlResSel 2Err]
	bit D	oFb43 [Drive Receive Time Over 5]
	bit E - F	Reserved
00E1	oFC0x Description (CN5-C)	
	bit 0	oFC00 [Option Not Compatible with Port]
	bit 1	oFC01 [Option Fault/Connection Error]
	bit 2	oFC02 [Duplicate Options]
	bit 3 - 4	Reserved
	bit 5	oFC05 [Option A/D Error]
	bit 6	oFC06 [Option Communication Error]
	bit 7 - F	Reserved
00E2	oFC1x Description (CN5-C)	
	bit 0	oFC10 [Option RAM Error]
	bit 1	oFC11 [Option Ope Mode Error]
	bit 2	oFC12 [Drive Receive CRC Error]
	bit 3	oFC13 [Drive Receive Frame Error]
	bit 4	oFC14 [Drive Receive Abort Error]
	bit 5	oFC15 [Option Receive CRC Error]
	bit 6	oFC16 [Option Receive Frame Error]
	bit 7	oFC17 [Option Receive Abort Error]
	bit 8 - F	Reserved
00E3	Reserved	

Register No. (Hex.)	Description	
00E4	oFC5x Description (CN5-C)	
	bit 0	oFC50 [Encoder Option A/D Conv Error]
	bit 1	oFC51 [EncOpAnlgCrctErr]
	bit 2	oFC52 [Encoder Option Comm Timeout]
	bit 3	oFC53 [Encoder Option Comm Data Fault]
	bit 4	oFC54 [Encoder Error]
	bit 5	oFC55 [Resolver Error]
bit 6 - F	Reserved	
00E5	Minor Fault Description 9	
	bit 0	EP24v [External Power 24V Supply]
	bit 1 - 3	Reserved
	bit 4	bAT [Keypad Battery Low Voltage]
	bit 5	Reserved
	bit 6	CP1 [Comparator 1 Limit Fault]
	bit 7	CP2 [Comparator 2 Limit Fault]
	bit 8	TiM [Keypad Time Not Set]
	bit 9	bCE [Bluetooth Communication Error]
	bit A - F	Reserved
00E6 - 00E9	Reserved	
00EA	Fault Description 11	
	bit 0	TiM [Keypad Time Not Set]
	bit 1	bAT [Keypad Battery Low Voltage]
	bit 2 - D	Reserved
	bit E	SCF [Safety Circuit Fault]
bit F	Reserved	
00EB - 00ED	Reserved	
00EE	Fault Description 12	
	bit 0 - 2	Reserved
	bit 3	CP1 [Comparator 1 Limit Fault]
	bit 4	CP2 [Comparator 2 Limit Fault]
	bit 5	bCE [Bluetooth Communication Fault]
bit 6 - F	Reserved	
00EF - 00F4	Reserved	
00F5	bit 0 - 5	Reserved
	bit 6	PSE [JOHB-SMP3 Protocol Set Error]
	bit 7 - F	Reserved
00E6 - 00FA	Reserved	
00FB	Output current Note: The unit of display is different for different models. 2004 to 2042, 4002 to 4023: 0.01 A 2056 to 2415, 4031 to 4675: 0.1 A 4810 to 4H12: 1 A	

■ Broadcast Messages

Broadcast messages are available as read-only.

The undefined bit signal in the broadcast operation signal uses the local data signal.

Table 6.17 Broadcast Messages for MEMOBUS/Modbus Communication

Register No. (Hex.)	Description	
0001	Operation signal	
	bit 0	Run command 1: Run, 0: Stop
	bit 1	Reverse run command 1: Reverse, 0: Forward run
	bit 2 - 3	Reserved
	bit 4	External fault 1: EF0 [Option Card External Fault]
	bit 5	Fault Reset 1: Reset command
	bit 6 - B	Reserved
	bit C	MFDI terminal S5 input
	bit D	MFDI terminal S6 input
	bit E	MFDI terminal S7 input
	bit F	MFDI terminal S8 input
0002	Frequency reference	30000/100%

■ Fault Trace/Fault History Contents

Table 6.18 shows the fault codes that the commands from monitors $[U2-xx, U3-xx]$ read.

Table 6.18 Fault Trace/Fault History Contents

Fault Code (Hex.)	Name	Fault Code (Hex.)	Name
0002	Uv1 [DC Bus Undervoltage]	001B	PF [Input Phase Loss]
0003	Uv2 [Control Power Undervoltage]	001C	LF [Output Phase Loss]
0004	Uv3 [Soft Charge Answerback Fault]	001D	oH3 [Motor Overheat (PTC Input)]
0005	SC [Short Circuit/IGBT Failure]	001E	oPr [Keypad Connection Fault]
0006	GF [Ground Fault]	001F	Err [EEPROM Write Error]
0007	oC [Overcurrent]	0020	oH4 [Motor Overheat Fault (PTC Input)]
0008	ov [Overvoltage]	0021	CE [Modbus Communication Error]
0009	oH [Heatsink Overheat]	0022	bUS [Option Communication Error]
000A	oH1 [Heatsink Overheat]	0025	CF [Control Fault]
000B	oL1 [Motor Overload]	0026	SvE [Zero Servo Fault]
000C	oL2 [Drive Overload]	0027	EF0 [Option Card External Fault]
000D	oL3 [Overtorque Detection 1]	0028	FbL [PID Feedback Loss]
000E	oL4 [Overtorque Detection 2]	0029	UL3 [Undertorque Detection 1]
000F	rr [Dynamic Braking Transistor Fault]	002A	UL4 [Undertorque Detection 2]
0010	rH [Braking Resistor Overheat]	002B	oL7 [High Slip Braking Overload]
0011	EF3 [External Fault (Terminal S3)]	0030	Includes oFx Fault [Hardware Fault]
0012	EF4 [External Fault (Terminal S4)]	0032	dv1 [Z Pulse Fault]
0013	EF5 [External Fault (Terminal S5)]	0033	dv2 [Z Pulse Noise Fault Detection]
0014	EF6 [External Fault (Terminal S6)]	0034	dv3 [Inversion Detection]
0015	EF7 [External Fault (Terminal S7)]	0035	dv4 [Inversion Prevention Detection]
0016	EF8 [External Fault (Terminal S8)]	0036	LF2 [Output Current Imbalance]
0017	FAn [Internal Fan Fault]	0037	STPo [Motor Step-Out Detected]
0018	oS [Overspeed]	0038	PGoH [Encoder (PG) Hardware Fault]
0019	dEv [Speed Deviation]	0039	E5 [MECHATROLINK Watchdog Timer Err]
001A	PGo [Encoder (PG) Feedback Loss]	003B	SER [Speed Search Retries Exceeded]

Fault Code (Hex.)	Name
0041	FbH [Excessive PID Feedback]
0042	EF1 [External Fault (Terminal S1)]
0043	EF2 [External Fault (Terminal S2)]
0044	oL5 [Mechanical Weakening Detection 1]
0045	UL5 [Mechanical Weakening Detection 2]
0046	CoF [Current Offset Fault]
0048	oH5 [Motor Overheat (NTC Input)]
0049	dWFL [DriveWorksEZ Fault]
004A	dWF1 [EEPROM Memory DWEZ Data Error]
004B	dWF2 [DriveWorksEZ Fault 2]
004C	dWF3 [DriveWorksEZ Fault 3]
004D	Tho [Thermistor Disconnect]
004E	rF [Braking Resistor Fault]
004F	boL [Braking Transistor Overload Fault]
0051	LSo [Low Speed Motor Step-Out]
0052	nSE [Node Setup Error]
005B	dv7 [Polarity Judge Timeout]
0083	CPF02 [Control Circuit Error]
0084	CPF03 [Control Circuit Error]
0087	CPF06 [Control Circuit Error]
0088	CPF07 [Control Circuit Error]
0089	CPF08 [Control Circuit Error]
008C	CPF11 [Control Circuit Error]
008D	CPF12 [Control Circuit Error]
008E	CPF13 [Control Circuit Error]
008F	CPF14 [Control Circuit Error]
0091	CPF16 [Control Circuit Error]
0092	CPF17 [Control Circuit Error]
0093	CPF18 [Control Circuit Error]
0094	CPF19 [Control Circuit Error]
0095	CPF20 [Control Circuit Error]
0096	CPF21 [Control Circuit Error]
0097	CPF22 [Control Circuit Error]
0098	CPF23 [Control Circuit Error]
0099	CPF24 [Control Circuit Error (Drive Unit Signal Fault)]
009B	CPF26 [Control Circuit Error]
009C	CPF27 [Control Circuit Error]
009D	CPF28 [Control Circuit Error]
009E	CPF29 [Control Circuit Error]
009F	CPF30 [Control Circuit Error]
00A0	CPF31 [Control Circuit Error]
00A1	CPF32 [Control Circuit Error]
00A2	CPF33 [Control Circuit Error]
00A3	CPF34 [Control Circuit Error]
00A4	CPF35 [Control Circuit Error]
00A5	CPF36 [Control Circuit Error]

Fault Code (Hex.)	Name
00A6	CPF37 [Control Circuit Error]
00A7	CPF38 [Control Circuit Error]
00A8	CPF39 [Control Circuit Error]
0101	oFA00 [Option Not Compatible with Port]
0102	oFA01 [Option Fault/Connection Error]
0106	oFA05 [Option A/D Error]
0107	oFA06 [Option Communication Error]
0111	oFA10 [Option RAM Error]
0112	oFA11 [Option Ope Mode Error]
0113	oFA12 [Drive Receive CRC Error]
0114	oFA13 [Drive Receive Frame Error]
0115	oFA14 [Drive Receive Abort Error]
0116	oFA15 [Option Receive CRC Error]
0117	oFA16 [Option Receive Frame Error]
0118	oFA17 [Option Receive Abort Error]
0131	oFA30 [COM ID Error]
0132	oFA31 [Type Code Error]
0133	oFA32 [SUM Check Error]
0134	oFA33 [Option Receive Time Over]
0135	oFA34 [Memobus Time Over]
0136	oFA35 [Drive Receive Time Over 1]
0137	oFA36 [CI Check Error]
0138	oFA37 [Drive Receive Time Over 1]
0139	oFA38 [Control Reference Error]
013A	oFA39 [Drive Receive Time Over 3]
013B	oFA40 [CtrlResSel 1Err]
013C	oFA41 [Drive Receive Time Over 4]
013D	oFA42 [CtrlResSel 2Err]
013E	oFA43 [Drive Receive Time Over 1]
0201	oFb00 [Option Not Compatible with Port]
0202	oFb01 [Option Fault/Connection Error]
0203	oFb02 [Duplicate Options]
0206	oFb05 [Option A/D Error]
0207	oFb06 [Option Communication Error]
0211	oFb10 [Option RAM Error]
0212	oFb11 [Option Ope Mode Error]
0213	oFb12 [Drive Receive CRC Error]
0214	oFb13 [Drive Receive Frame Error]
0215	oFb14 [Drive Receive Abort Error]
0216	oFb15 [Option Receive CRC Error]
0217	oFb16 [Option Receive Frame Error]
0218	oFb17 [Option Receive Abort Error]
0231	oFb30 [COM ID Error]
0232	oFb31 [Type Code Error]
0233	oFb32 [SUM Check Error]
0234	oFb33 [Option Receive Time Over]

6.3 MEMOBUS/Modbus Communications

Fault Code (Hex.)	Name
0235	oFb34 [Memobus Time Over]
0236	oFb35 [Drive Receive Time Over 1]
0237	oFb36 [CI Check Error]
0238	oFb37 [Drive Receive Time Over 1]
0239	oFb38 [Control Reference Error]
023A	oFb39 [Drive Receive Time Over 3]
023B	oFb40 [CtrlResSel 1Err]
023C	oFb41 [Drive Receive Time Over 1]
023D	oFb42 [CtrlResSel 2Err]
023E	oFb43 [Drive Receive Time Over 5]
0301	oFC00 [Option Not Compatible with Port]
0302	oFC01 [Option Fault/Connection Error]
0303	oFC02 [Duplicate Options]
0306	oFC05 [Option A/D Error]
0307	oFC06 [Option Communication Error]
0311	oFC10 [Option RAM Error]
0312	oFC11 [Option Ope Mode Error]
0313	oFC12 [Drive Receive CRC Error]
0314	oFC13 [Drive Receive Frame Error]

Fault Code (Hex.)	Name
0315	oFC14 [Drive Receive Abort Error]
0316	oFC15 [Option Receive CRC Error]
0317	oFC16 [Option Receive Frame Error]
0318	oFC17 [Option Receive Abort Error]
0351	oFC50 [Encoder Option A/D Conv Error]
0352	oFC51 [EncOpAnlgCrctErr]
0353	oFC52 [Encoder Option Comm Timeout]
0354	oFC53 [Encoder Option Comm Data Fault]
0355	oFC54 [Encoder Error]
0356	oFC55 [Resolver Error]
0401	TiM [Keypad Time Not Set]
0402	bAT [Keypad Battery Low Voltage]
040F	SCF [Safety Circuit Fault]
0413	FAn1 [Drive Cooling Fan Failure]
0414	CP1 [Comparator 1 Limit Fault]
0415	CP2 [Comparator 2 Limit Fault]
0416	bCE [Bluetooth Communication Fault]
0437	PSE [JOHB-SMP3 Protocol Set Error]

■ Minor Fault/Alarm Contents

Table 6.19 shows the minor fault/alarm codes that communications register (007F (Hex.)) reads.

Table 6.19 Minor Fault/Alarm Contents (007 (Hex.))

Minor Fault/Alarm Code (Hex.)	Name	Minor Fault/Alarm Code (Hex.)	Name
0001	Uv [Undervoltage]	0017	oL1 [Motor Overload]
0002	ov [Overvoltage]	0018	oL2 [Drive Overload]
0003	oH [Heatsink Overheat]	001A	EF0 [Option Card External Fault]
0004	oH2 [External Overheat (H1-XX=B)]	001B	rUn [Motor Switch during Run]
0005	oL3 [Overtorque 1]	001D	CALL [Serial Comm Transmission Error]
0006	oL4 [Overtorque 2]	001E	UL3 [Undertorque Detection 1]
0007	EF [FWD/REV Run Command Input Error]	001F	UL4 [Undertorque Detection 2]
0008	bb [Baseblock]	0020	SE [Modbus Test Mode Error]
0009	EF3 [External Fault (Terminal S3)]	0021	L24v [Loss of External Power 24 Supply]
000A	EF4 [External Fault (Terminal S4)]	0022	oH3 [Motor Overheat (PTC Input)]
000B	EF5 [External Fault (Terminal S5)]	0027	FbL [PID Feedback Loss]
000C	EF6 [External Fault (Terminal S6)]	0028	FbH [Excessive PID Feedback]
000D	EF7 [External Fault (Terminal S7)]	002A	dnE [Drive Disabled]
000E	EF8 [External Fault (Terminal S8)]	002B	PGoH [Encoder (PG) Hardware Fault]
000F	FAn [Internal Fan Fault]	0031	E5 [MECHATROLINK Watchdog Timer Err]
0010	oS [Overspeed]	0032	AEr [Station Address Setting Error]
0011	dEv [Speed Deviation]	0033	CyC [MECHATROLINK CommCycleSettingErr]
0012	PGo [Encoder (PG) Feedback Loss]	0034	HCA [High Current Alarm]
0014	CE [Modbus Communication Error]	0035	LT-1 [Cooling Fan Maintenance Time]
0015	bUS [Option Communication Error]	0036	LT-2 [Capacitor Maintenance Time]
0016	CALL [Serial Comm Transmission Error]	0039	EF1 [External Fault (Terminal S1)]

Minor Fault/ Alarm Code (Hex.)	Name	Minor Fault/ Alarm Code (Hex.)	Name
003A	EF2 [External Fault (Terminal S2)]	004B	dWA3 [DriveWorksEZ Alarm 3]
003B	SToF [Safe Torque OFF Hardware]	0050	oH5 [Motor Overheat (NTC Input)]
003D	oL5 [Mechanical Weakening Detection 1]	0053	Tho [Thermistor Disconnect]
003E	UL5 [Mechanical Weakening Detection 2]	0081	EP24v [External Power 24V Supply]
0042	TrPC [IGBT Maintenance Time (90%)]	0085	bAT [Keypad Battery Low Voltage]
0043	LT-3 [SoftChargeBypassRelay MainteTime]	0087	CP1 [Comparator 1 Limit Fault]
0044	LT-4 [IGBT Maintenance Time (50%)]	0088	CP2 [Comparator 2 Limit Fault]
0045	boL [Braking Transistor Overload]	0089	TiM [Keypad Time Not Set]
0049	dWAL [DriveWorksEZ Alarm]	008A	bCE [Bluetooth Communication Error]
004A	dWA2 [DriveWorksEZ Alarm 2]		

◆ Error Codes

■ MEMOBUS/Modbus Communications Error Code List

Table 6.20 lists the MEMOBUS/Modbus communications error codes.

When an error occurs, remove the cause of the error and restart communications.

Table 6.20 MEMOBUS/Modbus Communications Error Codes

Error Code (Hex.)	Name	Cause
01	Function Code Error	The PLC set a function code that was not 03, 08, or 10 (Hex.)
02	Register Number Error	<ul style="list-style-type: none"> The register number that is trying to access is not registered. A starting number that was not 0001 or 0002 (Hex.) was set when broadcasting.
03	Bit Count Error	<ul style="list-style-type: none"> Read and write data quantities are more than the 1 to 16 range. (Command message data quantity is disabled.) The data that was read from non-consecutive holding registers contained more than 120 bytes. The data to be written to non-consecutive holding registers contained more than 60 bytes. In the write mode, the number of bytes in the message is not the number of data × 2.
21	Data Setting Error	<ul style="list-style-type: none"> Writing control data or parameters made the settings go out of the permitted setting range. A parameter setting error occurred when writing a parameter.
22	Write Mode Error	<ul style="list-style-type: none"> Tried to write a disabled parameter during run. When there was a CPF06 [Control Circuit Error], the master tried to write a parameter other than one of these: <ul style="list-style-type: none"> A1-00 [Language Selection] A1-01 [Access Level Selection] A1-02 [Control Method Selection] A1-03 [Initialize Parameters] A1-04 [Password] A1-05 [Password Setting] E1-03 [V/f Pattern Selection] o2-04 [Drive Model (KVA) Selection] Writes the read-only data.
23	DC Bus Undervoltage Write Error	During U_v [DC Bus Undervoltage], a U_v write disabled parameter was written.
24	Error Writing Data During Parameter Processing	Tried to write a parameter from the master during parameter processing on the drive side.
25	Writing into EEPROM Disabled	Writing into EEPROM write is disabled, but EEPROM write was executed from MEMOBUS/Modbus communications. When this error occurs, the keypad shows a message and the drive continues operation.

■ No Response from Slave

The slave ignores the command message from the master and will not send a response message in these conditions:

- When a communications error (overrun, framing, parity, CRC-16) is detected in the command message.
- When the slave address in the command message and the slave address for the drive side do not agree (Use H5-01 [Drive Node Address] to set the slave address of the drive)
- When the time interval between the data of which the message is composed is longer than 24 bits

- When the data length for the command message is not accurate

Note:

- If the keypad shows *CALL [Serial Comm Transmission Error]*, refer to “Troubleshooting” to remove the cause of the error, and try to do communications again. If the keypad does not show *CALL*, check *U1-19 [MEMOBUS/Modbus Error Code]* for the error and error type.
- If you execute the write function code when the slave address in the command message is 00 (Hex.), all of the slaves will execute the write command, but they will not send response messages to the master.

Troubleshooting

7.1	Section Safety	334
7.2	Types of Faults, Minor Faults, Alarms, and Errors	336
7.3	List of Fault, Minor Fault, Alarm, and Error Codes	337
7.4	Fault	342
7.5	Minor Faults/Alarms	371
7.6	Parameter Setting Errors.....	382
7.7	Auto-Tuning Errors	387
7.8	Backup Function Operating Mode Display and Errors.....	392
7.9	Diagnosing and Resetting Faults.....	393
7.10	Troubleshooting Without Fault Display.....	394

7.1 Section Safety

DANGER

Electrical Shock Hazard

Do not examine, connect, or disconnect wiring on an energized drive. Before servicing, disconnect all power to the equipment and wait for the time specified on the warning label at a minimum. The internal capacitor stays charged after the drive is de-energized. The charge indicator LED extinguishes when the DC bus voltage decreases below 50 Vdc. When all indicators are OFF, remove the covers before measuring for dangerous voltages to make sure that the drive is safe.

If you do work on the drive when it is energized, it will cause serious injury or death from electrical shock.

WARNING

Electrical Shock Hazard

Do not operate the drive when covers are missing. Replace covers and shields before you operate the drive. Use the drive only as specified by the instructions.

Some figures in this section include drives without covers or safety shields to more clearly show the inside of the drive. If covers or safety shields are missing from the drive, it can cause serious injury or death.

Always ground the motor-side grounding terminal.

If you do not ground the equipment correctly, it can cause serious injury or death if you touch the motor case.

After the drive blows a fuse or trips an RCM/RCD, do not immediately energize the drive or operate peripheral devices. Wait for the time specified on the warning label at a minimum and make sure that all indicators are OFF. Then check the wiring and peripheral device ratings to find the cause of the problem. If you do not know the cause of the problem, contact Yaskawa before you energize the drive or peripheral devices.

If you do not fix the problem before you operate the drive or peripheral devices, it can cause serious injury or death.

Only let approved personnel install, wire, maintain, examine, replace parts, and repair the drive.

If personnel are not approved, it can cause serious injury or death.

Do not wear loose clothing or jewelry when you do work on the drive. Tighten loose clothing and remove all metal objects, for example watches or rings.

Loose clothing can catch on the drive and jewelry can conduct electricity and cause serious injury or death.

Do not remove covers or touch circuit boards while the drive is energized.

If you touch the internal components of an energized drive, it can cause serious injury or death.

Do not modify the drive body or drive circuitry.

Modifications to drive body and circuitry can cause serious injury or death, will cause damage to the drive, and will void the warranty. Yaskawa is not responsible for modifications of the product made by the user.

Fire Hazard

Tighten all terminal screws to the correct tightening torque.

Connections that are too loose or too tight can cause incorrect operation and damage to the drive. Incorrect connections can also cause death or serious injury from fire.

Tighten screws at an angle in the specified range shown in this manual.

If you tighten the screws at an angle not in the specified range, you can have loose connections that can cause damage to the terminal block or start a fire and cause serious injury or death.

Damage to Equipment

Do not apply incorrect voltage to the main circuit of the drive. Operate the drive in the specified range of the input voltage on the drive nameplate.

Voltages that are higher than the permitted nameplate tolerance can cause damage to the drive.

⚠ WARNING**Fire Hazard**

Do not put flammable or combustible materials on top of the drive and do not install the drive near flammable or combustible materials. Attach the drive to metal or other noncombustible material.

Flammable and combustible materials can start a fire and cause serious injury or death.

Crush Hazard

Wear eye protection when you do work on the drive.

If you do not use correct safety equipment, it can cause serious injury or death.

Use a crane or hoist to move large drives when necessary.

If you try to move a large drive without a crane or hoist, it can cause serious injury or death.

NOTICE**Damage to Equipment**

When you touch the drive and circuit boards, make sure that you observe correct electrostatic discharge (ESD) procedures.

If you do not follow procedures, it can cause ESD damage to the drive circuitry.

Do not break the electrical connection between the drive and the motor when the drive is outputting voltage.

Incorrect equipment sequencing can cause damage to the drive.

Make sure that all connections are correct after you install the drive and connect peripheral devices.

Incorrect connections can cause damage to the drive.

Note:

Do not use unshielded wire for control wiring. Use shielded, twisted-pair wires and ground the shield to the ground terminal of the drive. Unshielded wire can cause electrical interference and unsatisfactory system performance.

7.2 Types of Faults, Minor Faults, Alarms, and Errors

If the drive or motor do not operate correctly, check the drive keypad for a code or message.



If problems occur that are not identified in this manual, contact the nearest Yaskawa representative with this information:

- Drive model
- Drive software version
- Date of purchase
- Description of the problem (such as failure conditions)

Table 7.1 contains descriptions of the different types of faults, minor faults, alarms, and errors that can occur during drive operation.

Contact Yaskawa if there is damage to the drive. Contact information is on the back cover of the manual.

Table 7.1 Types of Faults, Minor Faults, Alarms, and Errors

Type	Drive Response
Faults	<p>When the drive detects a fault, it will cause these conditions:</p> <ul style="list-style-type: none"> • The keypad shows the fault code and  and ALM/ERR of the LED Status Ring illuminate continuously. • The drive shuts off output, and the motor coasts to a stop. Some faults let the user select a motor stopping method. • Fault relay output MA-MC will turn ON, and MB-MC will turn OFF. <p>The drive will not operate until you clear the fault with a Fault Reset and the drive goes back to usual status.</p>
Minor Faults/Alarms	<p>When the drive detects a minor fault or an alarm, it will cause these conditions:</p> <ul style="list-style-type: none"> • The keypad shows the alarm code and  and ALM/ERR on the LED Status Ring flash. • The drive will continue to operate the motor. Some alarms let the user select a motor stopping method. • If the drive detects a minor fault, the terminal set to H2-01 to H2-03 = 10 [MFDO Function Select = Alarm] will switch ON. If you do not set parameters H2-01 to H2-03, the drive will not trigger MFDO terminals when it detects a minor fault. • The drive will not output a minor fault signal when it detects an alarm. <p>It is not necessary to do Fault Reset.</p>
Operation Errors	<p>An error occurs when parameter settings do not agree or a parameter combination is incorrect. The drive will not operate until you set the parameters correctly.</p> <p>When the drive detects an operation error, these conditions will result:</p> <ul style="list-style-type: none"> • The keypad shows the error code. • Multi-function outputs do not output an alarm signal. <p>Find the parameters that caused the error and correct the settings.</p>
Auto-Tuning Errors	<p>An error occurs during Auto-Tuning.</p> <p>When the drive detects a tuning error, it will cause these conditions:</p> <ul style="list-style-type: none"> • The keypad shows the error code. • Multi-function outputs do not output an alarm signal. • The motor coasts to stop. <p>Remove the cause of the error and do Auto-Tuning again.</p>
Copy Function Errors	<p>An error occurs when you use the keypad for a backup, restore, or verify operation.</p> <p>When the drive detects a copy function error, it will cause these conditions:</p> <ul style="list-style-type: none"> • The keypad shows the error code. • Multi-function outputs do not output an alarm signal. <p>Push a key on the keypad to clear the error. Remove the cause of the error and try the backup, restore, or verify operation again.</p>

7.3 List of Fault, Minor Fault, Alarm, and Error Codes

Table 7.2 shows the possible fault, minor fault, alarm, and error codes.

The display codes are in alphabetical order. Search the table for the code shown on the keypad, and identify its causes and possible solutions.

Note:

The number in parentheses adjacent to the code in the table identifies the fault code or minor fault code (hex. number) that was read during MEMOBUS/Modbus communications.

Example: AEr (0032)

Table 7.2 List of Fault, Minor Fault, Alarm, and Error Codes

Display (Hex.)	Name	ALM LED	Type	Ref.
AEr (0032)	Station Address Setting Error	Flashing	Alarm	371
bAT (0085)	Keypad Battery Low Voltage	Flashing	Alarm	371
bAT (0402)	Keypad Battery Low Voltage	Illuminated	Fault	342
bb (0008)	Baseblock	Flashing	Alarm	371
bCE (008A)	Bluetooth Communication Error	Flashing	Alarm	371
bCE (0416)	Bluetooth Communication Fault	Illuminated	Fault	342
boL (0045)	Braking Transistor Overload	Flashing	Alarm	371
boL (004F)	Braking Transistor Overload Fault	Illuminated	Fault	342
bUS (0015)	Option Communication Error	Flashing	Alarm	371
bUS (0022)	Option Communication Error	Illuminated	Fault	342
bUSy	Busy	-	Not an alarm.	372
CALL (001D)	Serial Comm Transmission Error	Flashing	Alarm	372
CE (0014)	Modbus Communication Error	Flashing	Alarm	372
CE (0021)	Modbus Communication Error	Illuminated	Fault	342
CF (0025)	Control Fault	Illuminated	Fault	343
CoF (0046)	Current Offset Fault	Illuminated	Fault	343
CP1 (0087)	Comparator 1 Limit Error	Flashing	Alarm	372
CP1 (0414)	Comparator 1 Limit Fault	Illuminated	Fault	343
CP2 (0088)	Comparator 2 Limit Error	Flashing	Alarm	373
CP2 (0415)	Comparator 2 Limit Fault	Illuminated	Fault	343
CPF00	Control Circuit Error	Illuminated	Fault	344
CPF01	Control Circuit Error	Illuminated	Fault	344
CPF02 (0083) CPF03 (0084)	Control Circuit Error	Illuminated	Fault	344, 344
CPF06 (0087)	Control Circuit Error (EEPROM Memory Data Error)	Illuminated	Fault	344
CPF07 (0088) CPF08 (0089)	Control Circuit Error	Illuminated	Fault	344, 344
CPF10 (008B) - CPF14 (008F)	Control Circuit Error	Illuminated	Fault	344 - 345
CPF16 (0091) - CPF23 (0098)	Control Circuit Error	Illuminated	Fault	345, 346
CPF24 (0099)	Control Circuit Error (Drive Unit Signal Fault)	Illuminated	Fault	346
CPF26 (009B) - CPF39 (00A8)	Control Circuit Error	Illuminated	Fault	346, 347
CPyE	Error Writing Data	-	Backup Function Runtime Error	392
CrST	Remove RUN Command to Reset	Flashing	Not an alarm.	373
CSEr	Control Mode Mismatch	-	Backup Function Runtime Error	392
CyC (0033)	MECHATROLINK CommCycleSettingErr	Flashing	Alarm	373
CyPo (0029)	Cycle Power to Accept Changes	Flashing	Alarm	373
dEv (0011)	Speed Deviation	Flashing	Alarm	373
dEv (0019)	Speed Deviation	Illuminated	Fault	348

7.3 List of Fault, Minor Fault, Alarm, and Error Codes

Display (Hex.)	Name	ALM LED	Type	Ref.
dFPS	Drive Model Mismatch	-	Backup Function Runtime Error	392
dnE (002A)	Drive Disabled	Flashing	Alarm	373
dv1 (0032)	Z Pulse Fault	Illuminated	Fault	348
dv2 (0033)	Z Pulse Noise Fault Detection	Illuminated	Fault	348
dv3 (0034)	Inversion Detection	Illuminated	Fault	348
dv4 (0035)	Inversion Prevention Detection	Illuminated	Fault	349
dv7 (005B)	Polarity Judge Timeout	Illuminated	Fault	349
dWA2 (004A)	DriveWorksEZ Alarm 2	Flashing	Alarm	373
dWA3 (004B)	DriveWorksEZ Alarm 3	Flashing	Alarm	373
dWAL (0049)	DriveWorksEZ Alarm	Flashing	Alarm	373
dWF1 (004A)	EEPROM Memory DWEZ Data Error	Illuminated	Fault	349
dWF2 (004B)	DriveWorksEZ Fault 2	Illuminated	Fault	349
dWF3 (004C)	DriveWorksEZ Fault 3	Illuminated	Fault	349
dWFL (0049)	DriveWorksEZ Fault	Illuminated	Fault	349
E5 (0031)	MECHATROLINK Watchdog Timer Err	Flashing	Alarm	373
E5 (0039)	MECHATROLINK Watchdog Timer Err	Illuminated	Fault	350
EF (0007)	FWD/REV Run Command Input Error	Flashing	Alarm	374
EF0 (001A)	Option Card External Fault	Flashing	Alarm	374
EF0 (0027)	Option Card External Fault	Illuminated	Fault	350
EF1 (0042)	External Fault (Terminal S1)	Illuminated	Fault	350
EF1 (0039)	External Fault (Terminal S1)	Flashing	Alarm	374
EF2 (003A)	External Fault (Terminal S2)	Flashing	Alarm	374
EF2 (0043)	External Fault (Terminal S2)	Illuminated	Fault	350
EF3 (0009)	External Fault (Terminal S3)	Flashing	Alarm	374
EF3 (0011)	External Fault (Terminal S3)	Illuminated	Fault	350
EF4 (000A)	External Fault (Terminal S4)	Flashing	Alarm	374
EF4 (0012)	External Fault (Terminal S4)	Illuminated	Fault	350
EF5 (000B)	External Fault (Terminal S5)	Flashing	Alarm	374
EF5 (0013)	External Fault (Terminal S5)	Illuminated	Fault	350
EF6 (000C)	External Fault (Terminal S6)	Flashing	Alarm	375
EF6 (0014)	External Fault (Terminal S6)	Illuminated	Fault	351
EF7 (000D)	External Fault (Terminal S7)	Flashing	Alarm	375
EF7 (0015)	External Fault (Terminal S7)	Illuminated	Fault	351
EF8 (000E)	External Fault (Terminal S8)	Flashing	Alarm	375
EF8 (0016)	External Fault (Terminal S8)	Illuminated	Fault	351
End1	Excessive Rated Voltage Setting	Flashing	Auto-Tuning Error	387
End2	Iron Core Saturation Coefficient	Flashing	Auto-Tuning Error	387
End3	Rated Current Setting Alarm	Flashing	Auto-Tuning Error	387
End4	Adjusted Slip Calculation Error	Flashing	Auto-Tuning Error	387
End5	Resistance Tuning Error	Flashing	Auto-Tuning Error	387
End6	Leakage Inductance Alarm	Flashing	Auto-Tuning Error	387
End7	No-Load Current Alarm	Flashing	Auto-Tuning Error	387
End8	HFI Alarm	Flashing	Auto-Tuning Error	388
End9	Initial Pole Detection Alarm	Flashing	Auto-Tuning Error	388
EP24v (0081)	External Power 24V Supply	Flashing	Alarm	375
Er-01	Motor Data Error	Flashing	Auto-Tuning Error	388

Display (Hex.)	Name	ALM LED	Type	Ref.
Er-02	Drive in an Alarm State	Flashing	Auto-Tuning Error	388
Er-03	STOP Button was Pressed	Flashing	Auto-Tuning Error	388
Er-04	Line-to-Line Resistance Error	Flashing	Auto-Tuning Error	389
Er-05	No-Load Current Error	Flashing	Auto-Tuning Error	389
Er-08	Rated Slip Error	Flashing	Auto-Tuning Error	389
Er-09	Acceleration Error	Flashing	Auto-Tuning Error	389
Er-10	Motor Direction Error	Flashing	Auto-Tuning Error	389
Er-11	Motor Speed Error	Flashing	Auto-Tuning Error	389
Er-12	Current Detection Error	Flashing	Auto-Tuning Error	390
Er-13	Leakage Inductance Error	Flashing	Auto-Tuning Error	390
Er-14	Motor Speed Error 2	Flashing	Auto-Tuning Error	390
Er-15	Torque Saturation Error	Flashing	Auto-Tuning Error	390
Er-16	Inertia ID Error	Flashing	Auto-Tuning Error	390
Er-17	Reverse Prohibited Error	Flashing	Auto-Tuning Error	390
Er-18	Back EMF Error	Flashing	Auto-Tuning Error	390
Er-19	PM Inductance Error	Flashing	Auto-Tuning Error	390
Er-20	Stator Resistance Error	Flashing	Auto-Tuning Error	390
Er-21	Z Pulse Correction Error	Flashing	Auto-Tuning Error	390
Er-25	HighFreq Inject Param Tuning Err	Flashing	Auto-Tuning Error	391
Err (001F)	EEPROM Write Error	Illuminated	Fault	351
FAn (000F)	Internal Fan Fault	Flashing	Alarm	375
FAn (0017)	Internal Fan Fault	Illuminated	Fault	351
FAn1 (0413)	Drive Cooling Fan Fault	Illuminated	Fault	351
FbH (0028)	Excessive PID Feedback	Flashing	Alarm	375
FbH (0041)	Excessive PID Feedback	Illuminated	Fault	352
FbL (0027)	PID Feedback Loss	Flashing	Alarm	375
FbL (0028)	PID Feedback Loss	Illuminated	Fault	352
GF (0006)	Ground Fault	Illuminated	Fault	352
HCA (0034)	High Current Alarm	Flashing	Alarm	376
HLCE (0411)	High Level Communication Errors	Illuminated	Fault	352
iFEr	Communication Err	-	Backup Function Runtime Error	392
L24v (0021)	Loss of External Power 24 Supply	Flashing	Alarm	376
LF (001C)	Output Phase Loss	Illuminated	Fault	352
LF2 (0036)	Output Current Imbalance	Illuminated	Fault	353
LoG	Log Com Error	Flashing	Alarm	376
LSo (0051)	Low Speed Motor Step-Out	Illuminated	Fault	353
LT-1 (0035)	Cooling Fan Maintenance Time	Flashing	Alarm	376
LT-2 (0036)	Capacitor Maintenance Time	Flashing	Alarm	376
LT-3 (0043)	SoftChargeBypassRelay MainteTime	Flashing	Alarm	377
LT-4 (0044)	IGBT Maintenance Time (50%)	Flashing	Alarm	377
ndAT	Model,VolClass,Capacity Mismatch	-	Backup Function Runtime Error	392
nSE (0052)	Node Setup Error	Illuminated	Fault	353
oC (0007)	Overcurrent	Illuminated	Fault	353
oFA00 (0101)	Option Not Compatible with Port	Illuminated	Fault	354
oFA01 (0102)	Option Fault/Connection Error	Illuminated	Fault	355
oFA02 (0103)	Duplicate Options	Illuminated	Fault	355

7.3 List of Fault, Minor Fault, Alarm, and Error Codes

Display (Hex.)	Name	ALM LED	Type	Ref.
oFA03 (0104) - oFA06 (0107)	Option Card Error at Option Port (CN5-A)	Illuminated	Fault	355, 355
oFA10 (0111) oFA11 (0112)	Option Card Error at Option Port (CN5-A)	Illuminated	Fault	355, 355
oFA12 (0113) - oFA17 (0118)	Option Card Connection Error (CN5-A)	Illuminated	Fault	355 - 356
oFA30 (0131) - oFA43 (013E)	Communication Option Card Connection Error (CN5-A)	Illuminated	Fault	356 - 358
oFb00 (0201)	Option Not Compatible with Port	Illuminated	Fault	358
oFb01 (0202)	Option Fault/Connection Error	Illuminated	Fault	358
oFb02 (0203)	Duplicate Options	Illuminated	Fault	358
oFb03 (0204) - oFb11 (0212)	Option Card Error Occurred at Option Port (CN5-B)	Illuminated	Fault	358 - 359
oFb12 (0213) - oFb17 (0218)	Option Card Connection Error (CN5-B)	Illuminated	Fault	359 - 359
oFC00 (0301)	Option Not Compatible with Port	Illuminated	Fault	359
oFC01 (0302)	Option Fault/Connection Error	Illuminated	Fault	359
oFC02 (0303)	Duplicate Options	Illuminated	Fault	360
oFC03 (0304) - oFC11 (0312)	Option Card Error Occurred at Option Port (CN5-C)	Illuminated	Fault	360 - 360
oFC12 (0313) - oFC17 (0318)	Option Card Connection Error (CN5-C)	Illuminated	Fault	360 - 361
oFC50 (0351) - oFC55 (0356)	Option Card Error Occurred at Option Port (CN5-C)	Illuminated	Fault	361 - 361
oH (0003)	Heatsink Overheat	Flashing	Alarm	377
oH (0009)	Heatsink Overheat	Illuminated	Fault	362
oH1 (000A)	Heatsink Overheat	Illuminated	Fault	362
oH2 (0004)	External Overheat (H1-XX=B)	Flashing	Alarm	377
oH3 (001D)	Motor Overheat (PTC Input)	Illuminated	Fault	362
oH3 (0022)	Motor Overheat (PTC Input)	Flashing	Alarm	377
oH4 (0020)	Motor Overheat Fault (PTC Input)	Illuminated	Fault	363
oL1 (000B)	Motor Overload	Illuminated	Fault	363
oL2 (000C)	Drive Overload	Illuminated	Fault	364
oL3 (0005)	Overtorque 1	Flashing	Alarm	378
oL3 (000D)	Overtorque Detection 1	Illuminated	Fault	364
oL4 (0006)	Overtorque 2	Flashing	Alarm	378
oL4 (000E)	Overtorque Detection 2	Illuminated	Fault	364
oL5 (003D)	Mechanical Weakening Detection 1	Flashing	Alarm	378
oL5 (0044)	Mechanical Weakening Detection 1	Illuminated	Fault	364
oL7 (002B)	High Slip Braking Overload	Illuminated	Fault	365
oPE01	Drive Capacity Setting Fault	Flashing	Parameter Setting Error	382
oPE02	Parameter Range Setting Error	Flashing	Parameter Setting Error	382
oPE03	Multi-Function Input Setting Err	Flashing	Parameter Setting Error	382
oPE05	Run Cmd/Freq Ref Source Sel Err	Flashing	Parameter Setting Error	383
oPE06	Control Method Selection Error	Flashing	Parameter Setting Error	384
oPE07	Analog Input Selection Error	Flashing	Parameter Setting Error	384
oPE08	Parameter Selection Error	Flashing	Parameter Setting Error	384
oPE09	PID Control Selection Fault	Flashing	Parameter Setting Error	385
oPE10	V/f Data Setting Error	Flashing	Parameter Setting Error	385
oPE11	Carrier Frequency Setting Error	Flashing	Parameter Setting Error	385
oPE13	Pulse Monitor Selection Error	Flashing	Parameter Setting Error	385
oPE15	Torque Control Setting Error	Flashing	Parameter Setting Error	386
oPE16	Energy Saving Constants Error	Flashing	Parameter Setting Error	386
oPE18	Online Tuning Param Setting Err	Flashing	Parameter Setting Error	386
oPE20	PG-F3 Setting Error	Flashing	Parameter Setting Error	386

Display (Hex.)	Name	ALM LED	Type	Ref.
oPE33	Digital Output Selection Error	Flashing	Parameter Setting Error	386
oPr (001E)	Keypad Connection Fault	Illuminated	Fault	365
oS (0010)	Overspeed	Flashing	Alarm	378
oS (0018)	Overspeed	Illuminated	Fault	365
ov (0002)	DC Bus Overvoltage	Flashing	Alarm	378
ov (0008)	Overvoltage	Illuminated	Fault	365
ovEr	Too Many Parameters Changed	-	Not an alarm.	379
PASS	Modbus Communication Test	Flashing	Not an alarm.	379
PE1 (0047)	PLC Fault 1	Illuminated	Fault	366
PE2 (0048)	PLC Fault 2	Illuminated	Fault	366
PF (0047)	Input Phase Loss	Flashing	Alarm	379
PF (001B)	Input Phase Loss	Illuminated	Fault	367
PGo (0012)	Encoder (PG) Feedback Loss	Flashing	Alarm	379
PGo (001A)	Encoder (PG) Feedback Loss	Illuminated	Fault	367
PGoH (002B)	Encoder (PG) Hardware Fault	Flashing	Alarm	379
PGoH (0038)	Encoder (PG) Hardware Fault	Illuminated	Fault	367
PSE (0437)	JOHB-SMP3 Protocol Set Error	Illuminated	Fault	367
PWEr	DWEZ Password Mismatch	-	Backup Function Runtime Error	392
rdEr	Error Reading Data	-	Backup Function Runtime Error	392
rF (004E)	Braking Resistor Fault	Illuminated	Fault	367
rH (0010)	Braking Resistor Overheat	Illuminated	Fault	367
rr (000F)	Dynamic Braking Transistor Fault	Illuminated	Fault	368
rUn (001B)	Motor Switch during Run	Flashing	Alarm	379
SC (0005)	Short Circuit/IGBT Failure	Illuminated	Fault	368
SCF (040F)	Safety Circuit Fault	Illuminated	Fault	368
SE (0020)	Modbus Test Mode Error	Flashing	Alarm	379
SEr (003B)	Speed Search Retries Exceeded	Illuminated	Fault	368
STo (003C)	Safe Torque OFF	-	Alarm	380
SToF (003B)	Safe Torque OFF	Flashing	Alarm	380
STPo (0037)	Motor Step-Out Detected	Illuminated	Fault	368
SvE (0026)	Zero Servo Fault	Illuminated	Fault	369
TiM (0089)	Keypad Time Not Set	Flashing	Alarm	380
TiM (0401)	Keypad Time Not Set	Illuminated	Fault	369
TrPC (0042)	IGBT Maintenance Time (90%)	Flashing	Alarm	380
UL3 (001E)	Undertorque Detection 1	Flashing	Alarm	380
UL3 (0029)	Undertorque Detection 1	Illuminated	Fault	369
UL4 (001F)	Undertorque Detection 2	Flashing	Alarm	380
UL4 (002A)	Undertorque Detection 2	Illuminated	Fault	369
UL5 (003E)	Mechanical Weakening Detection 2	Flashing	Alarm	380
UL5 (0045)	Mechanical Weakening Detection 2	Illuminated	Fault	369
Uv (0001)	Undervoltage	Flashing	Alarm	380
Uv1 (0002)	DC Bus Undervoltage	Illuminated	Fault	369
Uv2 (0003)	Control Power Undervoltage	Illuminated	Fault	370
Uv3 (0004)	Soft Charge Answerback Fault	Illuminated	Fault	370
vAEr	Voltage Class, Capacity Mismatch	-	Backup Function Runtime Error	392
vFyE	Parameters do not Match	-	Backup Function Runtime Error	392

7.4 Fault

This section gives information about some of the causes and possible solutions of faults. You must use the Fault Reset operation to remove the fault before you can operate the drive. Use the information in this table to remove the cause of the fault.

Code	Name	Causes	Possible Solutions
bAT	Keypad Battery Low Voltage	The keypad battery voltage is low.	Replace the keypad battery.
Note: Use o4-24 [bAT Detection Selection] to enable/disable bAT detection.			
Code	Name	Causes	Possible Solutions
bCE	Bluetooth Communication Fault	The smartphone or tablet with DriveWizard Mobile or DriveWizard installed is too far from the keypad.	Use the smartphone or tablet 10 m (32.8 ft) or nearer to the keypad. Note: bCE can occur when the smartphone or tablet is 10 m (32.8 ft) or nearer to the keypad depending on the specifications of the smartphone or tablet.
		Radio waves from a different device are causing interference with communications between the smartphone or tablet and keypad.	Make sure that no device around the keypad uses the same radio bandwidth (2400 MHz to 2480 MHz), and prevent radio interference.
Note: <ul style="list-style-type: none"> The drive detects this error when you use the Bluetooth LCD keypad to operate the drive from a smartphone or tablet. Do a Fault Reset to clear the fault. Set the stopping method for this fault in o2-27 [bCE Detection Selection]. 			
Code	Name	Causes	Possible Solutions
boL	BrakingTransistor Overload Fault	The duty cycle of the braking transistor is high (the regeneration power or repetition frequency is high).	<ul style="list-style-type: none"> Install a braking unit (CDBR-series). Install a regenerative converter. Increase the deceleration time.
		You enabled the protective function for the braking transistor when you have a regenerative converter.	Set L8-55 = 0 [Internal DB TransistorProtection = Disable].
		The braking transistor in the drive is broken.	Replace the entire drive.
Note: Do a Fault Reset to clear the fault.			
Code	Name	Causes	Possible Solutions
bUS	Option Communication Error	The drive did not receive a signal from the controller.	Correct wiring errors.
		The communications cable wiring is incorrect.	
		There is a short-circuit in the communications cable or the communications cable is not connected.	<ul style="list-style-type: none"> Repair short circuits and connect cables. Replace the defective communications cable.
		Electrical interference caused a communication data error.	<ul style="list-style-type: none"> Examine the control circuit lines, main circuit lines, and ground wiring, and decrease the effects of electrical interference. Make sure that a magnetic contactor is not the source of the electrical interference, then use a Surge Protective Device if necessary. Use only the recommended cables or other shielded line. Ground the shield on the controller side or the drive input power side. Separate the communication wiring from drive power lines, and install a noise filter to the input side of the power supply for communication. Decrease the effects of electrical interference from the controller.
		The option is incorrectly installed to the drive.	Correctly install the option to the drive.
	The option is damaged.	If the fault continues and the wiring is correct, replace the option.	
Note: <ul style="list-style-type: none"> The drive detects this error if the Run command or frequency reference is assigned to the option card. Do a Fault Reset to clear the fault. If the drive detects this error, the drive will operate the motor as specified by the stopping method set in F6-01 [Communication Error Selection]. 			
Code	Name	Causes	Possible Solutions
CE	Modbus Communication Error	The communications cable wiring is incorrect.	Correct wiring errors.
		There is a short circuit in the communications cable or the communications cable is not connected.	<ul style="list-style-type: none"> Repair short circuits and connect cables. Replace the defective communications cable.

Code	Name	Causes	Possible Solutions
		Electrical interference caused a communication data error.	<ul style="list-style-type: none"> Examine the control circuit lines, main circuit lines, and ground wiring, and decrease the effects of electrical interference. Make sure that a magnetic contactor is not the source of the electrical interference, then use a Surge Protective Device if necessary. Use only the recommended cables or other shielded line. Ground the shield on the controller side or the drive input power side. Separate the communication wiring from drive power lines, and install a noise filter to the input side of the power supply for communication. Decrease the effects of electrical interference from the controller.
Note: <ul style="list-style-type: none"> The drive detects this error if it does not correctly receive control data for the CE detection time set to H5-09 [CE Detection Time]. Do a Fault Reset to clear the fault. If the drive detects this error, the drive will operate the motor as specified by the stopping method set in H5-04 [Communication Error Stop Method]. 			
Code	Name	Causes	Possible Solutions
CF	Control Fault	Motor parameters are set incorrectly	Correctly set the motor parameters and do Auto-Tuning again.
		When A1-02 = 4 [Control Method Selection = Advanced Open Loop Vector], the drive takes long to ramp to stop because of these settings: <ul style="list-style-type: none"> The torque limit setting is too low. L3-11 = 1 [Overvoltage Suppression Select = Enabled]. d5-01 = 1 [Torque Control Selection = Torque Control]. 	When Rotational Auto-Tuning changes or the installation environment changes, make sure that you do Line-to-Line Resistance Tuning and set L8-20 = 0 [Control Fault & Step Out Detect = Disabled]. <p>Note: After you set L8-20 = 0, do test runs and examine the drive to make sure that it starts and stops correctly.</p>
		The torque limit setting is too low.	Adjust L7-01 to L7-04 [Torque Limit].
		The load inertia is too large.	<ul style="list-style-type: none"> Adjust C1-02, C1-04, C1-06, and C1-08 [Deceleration Times]. Set the frequency reference to the minimum output frequency, and stop the Run command when the drive stops deceleration.
		The drive is trying to ramp to stop a machine that cannot do ramp to stop or on a machine for which deceleration is not necessary.	Correctly set b1-03 [Stopping Method Selection].
		The motor and drive are connected incorrectly.	Correct wiring errors.
		Line-to-line Resistance Tuning is not done.	Do Stationary Auto-Tuning for Line-to-Line Resistance.
		The drive received a Run command while the motor was coasting.	<ul style="list-style-type: none"> Examine the sequence and input the Run command after the motor fully stops. Set b3-01 = 1 [Speed Search at Start Selection = Enabled].
Note: <ul style="list-style-type: none"> The drive detects this error if the torque reference is more than the torque limit for 3 seconds or longer while the drive ramps to stop. Do a Fault Reset to clear the fault. 			
Code	Name	Causes	Possible Solutions
CoF	Current Offset Fault	The drive starts operation while the induced voltage stays in the motor (during coasting to a stop or after fast deceleration).	<ul style="list-style-type: none"> Make a sequence that does not restart operation when induced voltage stays in the motor. Set b3-01 = 1 [Speed Search at Start Selection = Enabled]. Use Speed Search from Fmax or Fref [H1-xx = 61, 62] to do a speed search through one of the external terminals. <p>Note: When controlling the PM motor, External Speed Search commands 1 and 2 operate the same.</p>
		A drive hardware problem occurred.	<ul style="list-style-type: none"> Do a Fault Reset to clear the fault or de-energize the drive. If the fault stays, replace the drive.
Code	Name	Causes	Possible Solutions
CP1	Comparator 1 Limit Fault	The monitor value set in H2-20 [Comparator 1 Monitor Selection] was in the range of H2-21 [Comparator 1 Lower Limit] and H2-22 [Comparator 1 Upper Limit].	Examine the monitor value and remove the cause of the fault.
Note: <ul style="list-style-type: none"> The drive detects this error when the terminal is set to H2-01 to H2-03 = 66 [MFDO Function Selection = Comparator1]. Do a Fault Reset to clear the fault. Set the stopping method for this fault in H2-33 [Comparator1 Protection Selection]. 			
Code	Name	Causes	Possible Solutions
CP2	Comparator 2 Limit Fault	The monitor value set in H2-26 [Comparator 2 Monitor Selection] was outside the range of H2-27 [Comparator 2 Lower Limit] and H2-28 [Comparator 2 Upper Limit].	Examine the monitor value and remove the cause of the fault.
Note: <ul style="list-style-type: none"> The drive detects this error when the terminal is set to H2-01 to H2-03 = 67 [MFDO Function Selection = Comparator2]. Do a Fault Reset to clear the fault. Set the stopping method for this fault in H2-35 [Comparator2 Protection Selection]. 			

7.4 Fault

Code	Name	Causes	Possible Solutions
CPF00	Control Circuit Error	A drive hardware problem occurred.	<ul style="list-style-type: none"> Re-energize the drive. If the fault stays, replace the control board or the drive. For information about replacing the control board, contact Yaskawa or your nearest sales representative.
Note: <ul style="list-style-type: none"> Do a Fault Reset to clear the fault. Fault trace is not available for these faults. 			
Code	Name	Causes	Possible Solutions
CPF01	Control Circuit Error	A drive hardware problem occurred.	<ul style="list-style-type: none"> Re-energize the drive. If the fault stays, replace the control board or the drive. For information about replacing the control board, contact Yaskawa or your nearest sales representative.
Note: <ul style="list-style-type: none"> Do a Fault Reset to clear the fault. Fault trace is not available for these faults. 			
Code	Name	Causes	Possible Solutions
CPF02	Control Circuit Error	A drive hardware problem occurred.	<ul style="list-style-type: none"> Re-energize the drive. If the fault stays, replace the control board or the drive. For information about replacing the control board, contact Yaskawa or your nearest sales representative.
Note: <ul style="list-style-type: none"> Do a Fault Reset to clear the fault. Fault trace is not available for these faults. 			
Code	Name	Causes	Possible Solutions
CPF03	Control Circuit Error	A drive hardware problem occurred.	<ul style="list-style-type: none"> Re-energize the drive. If the fault stays, replace the control board or the drive. For information about replacing the control board, contact Yaskawa or your nearest sales representative.
Note: <ul style="list-style-type: none"> Do a Fault Reset to clear the fault. Fault trace is not available for these faults. 			
Code	Name	Causes	Possible Solutions
CPF06	Control Circuit Error (EEPROM memory Data Error)	The drive power supply was de-energized while a communication option entered a parameter Write command.	Set A1-03 = 2220, 3330 [Initialize Parameters = 2-Wire Initialization, 3-Wire Initialization] and initialize the drive.
		An EEPROM peripheral circuit error occurred.	<ul style="list-style-type: none"> Re-energize the drive. If the fault stays, replace the control board or the drive. For information about how to replace the control board, contact Yaskawa or your nearest sales representative.
Note: <ul style="list-style-type: none"> The drive detects this error if there is an error in the data written to the drive EEPROM. Do a Fault Reset to clear the fault. Fault trace is not available for these faults. 			
Code	Name	Causes	Possible Solutions
CPF07	Control Circuit Error	A drive hardware problem occurred.	<ul style="list-style-type: none"> Re-energize the drive. If the fault stays, replace the control board or the drive. For information about replacing the control board, contact Yaskawa or your nearest sales representative.
Note: <ul style="list-style-type: none"> Do a Fault Reset to clear the fault. Fault trace is not available for these faults. 			
Code	Name	Causes	Possible Solutions
CPF08	Control Circuit Error	A drive hardware problem occurred.	<ul style="list-style-type: none"> Re-energize the drive. If the fault stays, replace the control board or the drive. For information about replacing the control board, contact Yaskawa or your nearest sales representative.
Note: <ul style="list-style-type: none"> Do a Fault Reset to clear the fault. Fault trace is not available for these faults. 			
Code	Name	Causes	Possible Solutions
CPF10	Control Circuit Error	A drive hardware problem occurred.	<ul style="list-style-type: none"> Re-energize the drive. If the fault stays, replace the control board or the drive. For information about replacing the control board, contact Yaskawa or your nearest sales representative.
Note: <ul style="list-style-type: none"> Do a Fault Reset to clear the fault. Fault trace is not available for these faults. 			

Code	Name	Causes	Possible Solutions
CPF11	Control Circuit Error	A drive hardware problem occurred.	<ul style="list-style-type: none"> Re-energize the drive. If the fault stays, replace the control board or the drive. For information about replacing the control board, contact Yaskawa or your nearest sales representative.
Note: <ul style="list-style-type: none"> Do a Fault Reset to clear the fault. Fault trace is not available for these faults. 			
Code	Name	Causes	Possible Solutions
CPF12	Control Circuit Error	A drive hardware problem occurred.	<ul style="list-style-type: none"> Re-energize the drive. If the fault stays, replace the control board or the drive. For information about replacing the control board, contact Yaskawa or your nearest sales representative.
Note: <ul style="list-style-type: none"> Do a Fault Reset to clear the fault. Fault trace is not available for these faults. 			
Code	Name	Causes	Possible Solutions
CPF13	Control Circuit Error	A drive hardware problem occurred.	<ul style="list-style-type: none"> Re-energize the drive. If the fault stays, replace the control board or the drive. For information about replacing the control board, contact Yaskawa or your nearest sales representative.
Note: <ul style="list-style-type: none"> Do a Fault Reset to clear the fault. Fault trace is not available for these faults. 			
Code	Name	Causes	Possible Solutions
CPF14	Control Circuit Error	A drive hardware problem occurred.	<ul style="list-style-type: none"> Re-energize the drive. If the fault stays, replace the control board or the drive. For information about replacing the control board, contact Yaskawa or your nearest sales representative.
Note: <ul style="list-style-type: none"> Do a Fault Reset to clear the fault. Fault trace is not available for these faults. 			
Code	Name	Causes	Possible Solutions
CPF16	Control Circuit Error	A drive hardware problem occurred.	<ul style="list-style-type: none"> Re-energize the drive. If the fault stays, replace the control board or the drive. For information about replacing the control board, contact Yaskawa or your nearest sales representative.
Note: <ul style="list-style-type: none"> Do a Fault Reset to clear the fault. Fault trace is not available for these faults. 			
Code	Name	Causes	Possible Solutions
CPF17	Control Circuit Error	A drive hardware problem occurred.	<ul style="list-style-type: none"> Re-energize the drive. If the fault stays, replace the control board or the drive. For information about replacing the control board, contact Yaskawa or your nearest sales representative.
Note: <ul style="list-style-type: none"> Do a Fault Reset to clear the fault. Fault trace is not available for these faults. 			
Code	Name	Causes	Possible Solutions
CPF18	Control Circuit Error	A drive hardware problem occurred.	<ul style="list-style-type: none"> Re-energize the drive. If the fault stays, replace the control board or the drive. For information about replacing the control board, contact Yaskawa or your nearest sales representative.
Note: <ul style="list-style-type: none"> Do a Fault Reset to clear the fault. Fault trace is not available for these faults. 			
Code	Name	Causes	Possible Solutions
CPF19	Control Circuit Error	A drive hardware problem occurred.	<ul style="list-style-type: none"> Re-energize the drive. If the fault stays, replace the control board or the drive. For information about replacing the control board, contact Yaskawa or your nearest sales representative.
Note: <ul style="list-style-type: none"> Do a Fault Reset to clear the fault. Fault trace is not available for these faults. 			
Code	Name	Causes	Possible Solutions
CPF20	Control Circuit Error	A drive hardware problem occurred.	<ul style="list-style-type: none"> Re-energize the drive. If the fault stays, replace the control board or the drive. For information about replacing the control board, contact Yaskawa or your nearest sales representative.
Note: <ul style="list-style-type: none"> Do a Fault Reset to clear the fault. Fault trace is not available for these faults. 			

7.4 Fault

Code	Name	Causes	Possible Solutions
CPF21	Control Circuit Error	A drive hardware problem occurred.	<ul style="list-style-type: none"> Re-energize the drive. If the fault stays, replace the control board or the drive. For information about replacing the control board, contact Yaskawa or your nearest sales representative.
Note: <ul style="list-style-type: none"> Do a Fault Reset to clear the fault. Fault trace is not available for these faults. 			
Code	Name	Causes	Possible Solutions
CPF22	Control Circuit Error	A drive hardware problem occurred.	<ul style="list-style-type: none"> Re-energize the drive. If the fault stays, replace the control board or the drive. For information about replacing the control board, contact Yaskawa or your nearest sales representative.
Note: <ul style="list-style-type: none"> Do a Fault Reset to clear the fault. Fault trace is not available for these faults. 			
Code	Name	Causes	Possible Solutions
CPF23	Control Circuit Error	A drive hardware problem occurred.	<ul style="list-style-type: none"> Re-energize the drive. If the fault stays, replace the control board or the drive. For information about replacing the control board, contact Yaskawa or your nearest sales representative.
Note: <ul style="list-style-type: none"> Do a Fault Reset to clear the fault. Fault trace is not available for these faults. 			
Code	Name	Causes	Possible Solutions
CPF24	Control Circuit Error (Drive Unit Signal Fault)	A drive hardware problem occurred.	<ul style="list-style-type: none"> Re-energize the drive. If the fault stays, replace the control board or the drive. For information about replacing the control board, contact Yaskawa or your nearest sales representative.
Note: <ul style="list-style-type: none"> Do a Fault Reset to clear the fault. Fault trace is not available for these faults. 			
Code	Name	Causes	Possible Solutions
CPF26	Control Circuit Error	A drive hardware problem occurred.	<ul style="list-style-type: none"> Re-energize the drive. If the fault stays, replace the control board or the drive. For information about replacing the control board, contact Yaskawa or your nearest sales representative.
Note: <ul style="list-style-type: none"> Do a Fault Reset to clear the fault. Fault trace is not available for these faults. 			
Code	Name	Causes	Possible Solutions
CPF27	Control Circuit Error	A drive hardware problem occurred.	<ul style="list-style-type: none"> Re-energize the drive. If the fault stays, replace the control board or the drive. For information about replacing the control board, contact Yaskawa or your nearest sales representative.
Note: <ul style="list-style-type: none"> Do a Fault Reset to clear the fault. Fault trace is not available for these faults. 			
Code	Name	Causes	Possible Solutions
CPF28	Control Circuit Error	A drive hardware problem occurred.	<ul style="list-style-type: none"> Re-energize the drive. If the fault stays, replace the control board or the drive. For information about replacing the control board, contact Yaskawa or your nearest sales representative.
Note: <ul style="list-style-type: none"> Do a Fault Reset to clear the fault. Fault trace is not available for these faults. 			
Code	Name	Causes	Possible Solutions
CPF29	Control Circuit Error	A drive hardware problem occurred.	<ul style="list-style-type: none"> Re-energize the drive. If the fault stays, replace the control board or the drive. For information about replacing the control board, contact Yaskawa or your nearest sales representative.
Note: <ul style="list-style-type: none"> Do a Fault Reset to clear the fault. Fault trace is not available for these faults. 			
Code	Name	Causes	Possible Solutions
CPF30	Control Circuit Error	A drive hardware problem occurred.	<ul style="list-style-type: none"> Re-energize the drive. If the fault stays, replace the control board or the drive. For information about replacing the control board, contact Yaskawa or your nearest sales representative.
Note: <ul style="list-style-type: none"> Do a Fault Reset to clear the fault. Fault trace is not available for these faults. 			

Code	Name	Causes	Possible Solutions
CPF31	Control Circuit Error	A drive hardware problem occurred.	<ul style="list-style-type: none"> Re-energize the drive. If the fault stays, replace the control board or the drive. For information about replacing the control board, contact Yaskawa or your nearest sales representative.
Note: <ul style="list-style-type: none"> Do a Fault Reset to clear the fault. Fault trace is not available for these faults. 			
Code	Name	Causes	Possible Solutions
CPF32	Control Circuit Error	A drive hardware problem occurred.	<ul style="list-style-type: none"> Re-energize the drive. If the fault stays, replace the control board or the drive. For information about replacing the control board, contact Yaskawa or your nearest sales representative.
Note: <ul style="list-style-type: none"> Do a Fault Reset to clear the fault. Fault trace is not available for these faults. 			
Code	Name	Causes	Possible Solutions
CPF33	Control Circuit Error	A drive hardware problem occurred.	<ul style="list-style-type: none"> Re-energize the drive. If the fault stays, replace the control board or the drive. For information about replacing the control board, contact Yaskawa or your nearest sales representative.
Note: <ul style="list-style-type: none"> Do a Fault Reset to clear the fault. Fault trace is not available for these faults. 			
Code	Name	Causes	Possible Solutions
CPF34	Control Circuit Error	A drive hardware problem occurred.	<ul style="list-style-type: none"> Re-energize the drive. If the fault stays, replace the control board or the drive. For information about replacing the control board, contact Yaskawa or your nearest sales representative.
Note: <ul style="list-style-type: none"> Do a Fault Reset to clear the fault. Fault trace is not available for these faults. 			
Code	Name	Causes	Possible Solutions
CPF35	Control Circuit Error	A drive hardware problem occurred.	<ul style="list-style-type: none"> Re-energize the drive. If the fault stays, replace the control board or the drive. For information about replacing the control board, contact Yaskawa or your nearest sales representative.
Note: <ul style="list-style-type: none"> Do a Fault Reset to clear the fault. Fault trace is not available for these faults. 			
Code	Name	Causes	Possible Solutions
CPF36	Control Circuit Error	A drive hardware problem occurred.	<ul style="list-style-type: none"> Re-energize the drive. If the fault stays, replace the control board or the drive. For information about replacing the control board, contact Yaskawa or your nearest sales representative.
Note: <ul style="list-style-type: none"> Do a Fault Reset to clear the fault. Fault trace is not available for these faults. 			
Code	Name	Causes	Possible Solutions
CPF37	Control Circuit Error	A drive hardware problem occurred.	<ul style="list-style-type: none"> Re-energize the drive. If the fault stays, replace the control board or the drive. For information about replacing the control board, contact Yaskawa or your nearest sales representative.
Note: <ul style="list-style-type: none"> Do a Fault Reset to clear the fault. Fault trace is not available for these faults. 			
Code	Name	Causes	Possible Solutions
CPF38	Control Circuit Error	A drive hardware problem occurred.	<ul style="list-style-type: none"> Re-energize the drive. If the fault stays, replace the control board or the drive. For information about replacing the control board, contact Yaskawa or your nearest sales representative.
Note: <ul style="list-style-type: none"> Do a Fault Reset to clear the fault. Fault trace is not available for these faults. 			
Code	Name	Causes	Possible Solutions
CPF39	Control Circuit Error	A drive hardware problem occurred.	<ul style="list-style-type: none"> Re-energize the drive. If the fault stays, replace the control board or the drive. For information about replacing the control board, contact Yaskawa or your nearest sales representative.
Note: <ul style="list-style-type: none"> Do a Fault Reset to clear the fault. Fault trace is not available for these faults. 			

7.4 Fault

Code	Name	Causes	Possible Solutions
dEv	Speed Deviation	The load is too heavy.	Decrease the load.
		Acceleration and deceleration times are set too short.	Increase the values set in <i>C1-01 to C1-08 [Acceleration/Deceleration Time]</i> .
		The <i>dEv</i> detection level settings are incorrect.	Adjust <i>F1-10 [Speed Deviation Detection Level]</i> and <i>F1-11 [Speed Deviation Detect DelayTime]</i> .
		The load is locked up.	Examine the machine.
		The holding brake is stopping the motor.	Release the holding brake.
Note: <ul style="list-style-type: none"> The drive detects this error if the difference between the detected speed and the speed reference is more than the setting of <i>F1-10</i> for longer than <i>F1-11</i>. Do a Fault Reset to clear the fault. If the drive detects this error, the drive will operate the motor as specified by the stopping method set in <i>F1-04 [Speed Deviation Detection Select]</i>. 			
Code	Name	Causes	Possible Solutions
dv1	Z Pulse Fault	The encoder option card or the encoder on the motor side is damaged.	<ol style="list-style-type: none"> 1. Repair wiring errors and connect disconnected wires. Correctly ground the shielded wire of the encoder cable. 2. Re-energize the drive 3. If the fault stays, replace the control board or the drive. For information about replacing the control board, contact Yaskawa or your nearest sales representative.
		The encoder cable is disconnected or wired incorrectly.	
Note: <ul style="list-style-type: none"> The drive detects this error if it does not detect a Z pulse during one motor rotation. Do a Fault Reset to clear the fault. 			
Code	Name	Causes	Possible Solutions
dv2	Z Pulse Noise Fault Detection	Noise interference along the encoder cable.	Isolate the encoder cable from the drive output line or a different source of electrical interference.
		The encoder cable is disconnected or wired incorrectly.	Examine for wiring errors or disconnected wires in the encoder cable, and repair problems. Correctly ground the shielded wire of the encoder cable.
		The drive is operating a motor with 24 or more poles at zero speed.	<ul style="list-style-type: none"> • Set <i>F1-46 = 1 [dv2 Detection Method Selection = MechanicalAngle Detection Method]</i>. • Increase <i>F1-17 [Deviation 2 Detection Selection]</i>. • Increase <i>F1-47 [Deviation 2 Detection Level]</i>. Note: If you change the setting of <i>F1-47</i> , the sensitivity of detection for <i>dv2</i> can decrease.
		The PG option or the encoder on the motor side is damaged.	Repair the wiring and re-energize the drive, then replace the PG option or the encoder if the problem continues.
Note: <ul style="list-style-type: none"> The drive detects this error if it detects more than one Z pulse per rotation for the number of rotations set in <i>F1-17 [Deviation 2 Detection Selection]</i>. Do a Fault Reset to clear the fault. 			
Code	Name	Causes	Possible Solutions
dv3	Inversion Detection	<i>E5-11 [Encoder Z-Pulse Offset]</i> is set incorrectly.	Correctly set the value for $\Delta\theta$ to <i>E5-11</i> as specified by the values on the motor nameplate.
		There is a new encoder or the motor rotation direction changed.	Do Z Pulse Offset Tuning.
		An external force on the load side rotated the motor.	<ul style="list-style-type: none"> • Make sure that the motor is rotating in the correct direction. • Find and repair problems on the load side that cause the motor to rotate from the load side.
		Noise interference along the encoder cable.	Correctly ground the shielded wire of the encoder cable.
		The encoder cable is disconnected or wired incorrectly.	Examine for wiring errors or disconnected wires in the encoder cable, and repair problems.
		The setting for <i>F1-05 [Encoder 1 Rotation Selection]</i> is the opposite of the direction of motor rotation.	Correctly connect the motor wiring for each phase (U, V, W).
		The drive incorrectly detected the motor magnetic pole position.	When <i>U6-57 [PolePolarityDeterVal] < 819</i> , increase <i>n8-84 [Polarity Detection Current]</i> . Consult the motor manufacturer for information about maximum setting values.
		<i>n8-84 [Polarity Detection Current]</i> is too low.	Increase <i>n8-84</i> from the default. Consult the motor manufacturer for information about maximum setting values.
		Pole Position Detection failed.	If you are using an IPM motor, do High Frequency Injection Auto-Tuning.
The PG option or the encoder on the motor side is damaged.	Repair the wiring and re-energize the drive, then replace the PG option card or the PG if the problem continues.		

Code	Name	Causes	Possible Solutions
		The drive incorrectly detected the motor magnetic pole position.	When <i>U6-57 [PolePolarityDeterVal]</i> < 819, set <i>n8-84 [Polarity Detection Current]</i> > default setting.
Note: <ul style="list-style-type: none"> The drive detects this error if: <ul style="list-style-type: none"> –the torque reference and acceleration are in opposite directions. –the speed reference and actual motor speed are more than 30% different for the number of times set to <i>F1-18 [Deviation 3 Detection Selection]</i>. Do a Fault Reset to clear the fault. 			
Code	Name	Causes	Possible Solutions
dv4	Inversion Prevention Detection	An external force on the load side rotated the motor.	<ul style="list-style-type: none"> Make sure that the motor is rotating in the correct direction. Find and repair problems on the load side that cause the motor to rotate from the load side. Disable detection of this fault for applications that rotate the motor from the load side in the opposite direction of the speed reference. The drive will not detect this fault if <i>F1-19 = 0 [Deviation 4 Detection Selection = Disabled]</i>.
		<i>E5-11 [Encoder Z-Pulse Offset]</i> is set incorrectly.	Correctly set the value for $\Delta\theta$ to <i>E5-11</i> as specified by the values on the motor nameplate.
		There is a new encoder or the motor rotation direction changed.	Do Z Pulse Offset Tuning.
		Noise interference along the encoder cable.	Correctly ground the shielded wire of the encoder cable.
		The encoder cable is disconnected or wired incorrectly.	Examine for wiring errors or disconnected wires in the encoder cable, and repair problems.
		The drive incorrectly detected the motor magnetic pole position.	If the value for <i>U6-57 [PolePolarityDeterVal]</i> is lower than 819, increase the value set in <i>n8-84 [Polarity Detection Current]</i> . Consult the motor manufacturer for information about maximum setting values.
		The setting of <i>n8-84 [Polarity Detection Current]</i> is too low.	Increase the <i>n8-84</i> setting from the default. Consult the motor manufacturer for information about maximum setting values.
		Pole Position Detection failed.	If you are using an IPM motor, do High Frequency Injection Auto-Tuning.
		The PG option card or the encoder on the motor side is damaged.	Repair the wiring and re-energize the drive, then replace the PG option card or the PG if the problem continues.
Note: <ul style="list-style-type: none"> The drive detects this error if the pulses in the opposite direction of the speed reference are more than the value set in <i>F1-19</i>. Do a Fault Reset to clear the fault. 			
Code	Name	Causes	Possible Solutions
dv7	Polarity Judge Timeout	There is a disconnection in the motor coil winding.	Measure the motor line-to-line resistance and replace the motor if a coil is disconnected.
		The screws on the drive output terminals are loose.	Tighten the terminal screws to the correct tightening torque.
Note: <ul style="list-style-type: none"> The drive detects this error if it cannot detect polarity in a pre-set length of time. Do a Fault Reset to clear the fault. 			
Code	Name	Causes	Possible Solutions
dWF1	EEPROM Memory DWEZ Data Error	There is an error in the EEPROM peripheral circuit.	<ul style="list-style-type: none"> Re-energize the drive. If the fault stays, replace the control board or the drive. For information about replacing the control board, contact Yaskawa or your nearest sales representative.
		There is a problem with the EEPROM data.	Set <i>A1-03 = 2220, 3330 [Initialize Parameters = 2-Wire Initialization, 3-Wire Initialization]</i> to initialize the drive, then upload the DriveWorksEZ project to the drive again.
Note: <ul style="list-style-type: none"> The drive detects this error if there is an error in the DriveWorksEZ program that was saved to EEPROM. Do a Fault Reset to clear the fault. 			
Code	Name	Causes	Possible Solutions
dWF2	DriveWorksEZ Fault 2	There was a fault in the DriveWorksEZ program.	Examine the DriveWorksEZ program and remove the cause of the fault. This is not a drive fault.
Note: Do a Fault Reset to clear the fault.			
Code	Name	Causes	Possible Solutions
dWF3	DriveWorksEZ Fault 3	There was a fault in the DriveWorksEZ program.	Examine the DriveWorksEZ program and remove the cause of the fault. This is not a drive fault.
Note: Do a Fault Reset to clear the fault.			
Code	Name	Causes	Possible Solutions
dWFL	DriveWorksEZ Fault	There was a fault in the DriveWorksEZ program.	Examine the DriveWorksEZ program and remove the cause of the fault. This is not a drive fault.
Note: Do a Fault Reset to clear the fault.			

7.4 Fault

Code	Name	Causes	Possible Solutions
E5	MECHATROLINK Watchdog Timer Err	The drive detected a watchdog circuit exception while it received data from the controller.	Examine the MECHATROLINK cable connection. If this error occurs frequently, examine the wiring and decrease the effects of electrical interference as specified by these manuals: <ul style="list-style-type: none"> MECHATROLINK-II Installation Guide (MECHATROLINK Members Association, manual number MMATDEP011) MECHATROLINK-III Installation Manual (MECHATROLINK Members Association, publication number MMATDEP018)
Note: <ul style="list-style-type: none"> Do a Fault Reset to clear the fault. If the drive detects this fault, it will operate the motor as specified by the stop method set in <i>F6-25 [MECHATROLINK Watchdog Error Sel]</i>. 			
Code	Name	Causes	Possible Solutions
EF0	Option Card External Fault	The communication option received an external fault from the controller.	<ol style="list-style-type: none"> Find the device that caused the external fault and remove the cause. Clear the external fault input from the controller.
		A programming error occurred on the controller side.	Examine the operation of the controller program.
Note: <ul style="list-style-type: none"> The drive detects this fault if the alarm function on the external device side is operating. Do a Fault Reset to clear the fault. If the drive detects this fault, it will operate the motor as specified by the stop method set in <i>F6-03 [Comm External Fault (EF0) Select]</i>. 			
Code	Name	Causes	Possible Solutions
EF1	External Fault (Terminal S1)	MFDI terminal S1 caused an external fault through an external device.	<ol style="list-style-type: none"> Find the device that caused the external fault and remove the cause. Clear the external fault input in the MFDI.
		The wiring is incorrect.	Correctly connect the signal line to MFDI terminal S1.
		<i>External Fault [HI-01 = 20 to 2B]</i> is set to MFDI terminal S1, but the terminal is not in use.	Correctly set the MFDI.
Note: <ul style="list-style-type: none"> Do a Fault Reset to clear the fault. 			
Code	Name	Causes	Possible Solutions
EF2	External Fault (Terminal S2)	MFDI terminal S2 caused an external fault through an external device.	<ol style="list-style-type: none"> Find the device that caused the external fault and remove the cause. Clear the external fault input in the MFDI.
		The wiring is incorrect.	Correctly connect the signal line to MFDI terminal S2.
		<i>External Fault [HI-02 = 20 to 2B]</i> is set to MFDI terminal S2, but the terminal is not in use.	Correctly set the MFDI.
Note: <ul style="list-style-type: none"> Do a Fault Reset to clear the fault. 			
Code	Name	Causes	Possible Solutions
EF3	External Fault (Terminal S3)	MFDI terminal S3 caused an external fault through an external device.	<ol style="list-style-type: none"> Find the device that caused the external fault and remove the cause. Clear the external fault input in the MFDI.
		The wiring is incorrect.	Correctly connect the signal line to MFDI terminal S3.
		<i>External Fault [HI-03 = 20 to 2B]</i> is set to MFDI terminal S3, but the terminal is not in use.	Correctly set the MFDI.
Note: <ul style="list-style-type: none"> Do a Fault Reset to clear the fault. 			
Code	Name	Causes	Possible Solutions
EF4	External Fault (Terminal S4)	MFDI terminal S4 caused an external fault through an external device.	<ol style="list-style-type: none"> Find the device that caused the external fault and remove the cause. Clear the external fault input in the MFDI.
		The wiring is incorrect.	Correctly connect the signal line to MFDI terminal S4.
		<i>External Fault [HI-04 = 20 to 2B]</i> is set to MFDI terminal S4, but the terminal is not in use.	Correctly set the MFDI.
Note: <ul style="list-style-type: none"> Do a Fault Reset to clear the fault. 			
Code	Name	Causes	Possible Solutions
EF5	External Fault (Terminal S5)	MFDI terminal S5 caused an external fault through an external device.	<ol style="list-style-type: none"> Find the device that caused the external fault and remove the cause. Clear the external fault input in the MFDI.
		The wiring is incorrect.	Correctly connect the signal line to MFDI terminal S5.

Code	Name	Causes	Possible Solutions
		<i>External Fault [H1-05 = 20 to 2B]</i> is set to MFDI terminal S5, but the terminal is not in use.	Correctly set the MFDI.
Note: Do a Fault Reset to clear the fault.			
Code	Name	Causes	Possible Solutions
EF6	External Fault (Terminal S6)	MFDI terminal S6 caused an external fault through an external device.	1. Find the device that caused the external fault and remove the cause. 2. Clear the external fault input in the MFDI.
		The wiring is incorrect.	Correctly connect the signal line to MFDI terminal S6.
		<i>External Fault [H1-06 = 20 to 2B]</i> is set to MFDI terminal S6, but the terminal is not in use.	Correctly set the MFDI.
Note: Do a Fault Reset to clear the fault.			
Code	Name	Causes	Possible Solutions
EF7	External Fault (Terminal S7)	MFDI terminal S7 caused an external fault through an external device.	1. Find the device that caused the external fault and remove the cause. 2. Clear the external fault input in the MFDI.
		The wiring is incorrect.	Correctly connect the signal line to MFDI terminal S7.
		<i>External Fault [H1-07 = 20 to 2B]</i> is set to MFDI terminal S7, but the terminal is not in use.	Correctly set the MFDI.
Note: Do a Fault Reset to clear the fault.			
Code	Name	Causes	Possible Solutions
EF8	External Fault (Terminal S8)	MFDI terminal S8 caused an external fault through an external device.	1. Find the device that caused the external fault and remove the cause. 2. Clear the external fault input in the MFDI.
		The wiring is incorrect.	Correctly connect the signal line to MFDI terminal S8.
		<i>External Fault [H1-08 = 20 to 2B]</i> is set to MFDI terminal S8, but the terminal is not in use.	Correctly set the MFDI.
Note: Do a Fault Reset to clear the fault.			
Code	Name	Causes	Possible Solutions
Err	EEPROM Write Error	There was a problem with the EEPROM hardware.	<ul style="list-style-type: none"> Re-energize the drive. If the fault stays, replace the control board or the drive. Contact Yaskawa or your nearest sales representative to replace the board.
		Electrical interference corrupted the data while it was writing to the EEPROM of the drive.	<ul style="list-style-type: none"> Push ENTER Key. Set the parameters again.
Note: Do a Fault Reset to clear the fault.			
Code	Name	Causes	Possible Solutions
FAn	Internal Fan Fault	The circulation fan stopped operating correctly.	<ul style="list-style-type: none"> Examine circulation fan operation. Re-energize the drive. Examine U4-03 [Cooling Fan Ope Time] and U4-04 [Cool Fan Maintenance]. If there is damage to the circulation fan or if the performance life of the fan is expired, replace the fan.
Note: Do a Fault Reset to clear the fault.			
Code	Name	Causes	Possible Solutions
FAnI	Drive Cooling Fan Fault	The cooling fan stopped operating correctly.	<ul style="list-style-type: none"> Examine cooling fan operation. Re-energize the drive. Examine U4-03 [Cooling Fan Ope Time] and U4-04 [Cool Fan Maintenance]. If the performance life of the cooling fan is expired or if there is damage to the fan, replace the fan.
		The circulation fan is damaged.	<ul style="list-style-type: none"> Examine circulation fan operation. Re-energize the drive. Examine U4-03 [Cooling Fan Ope Time] and U4-04 [Cool Fan Maintenance]. If there is damage to the circulation fan or if the performance life of the fan is expired, replace the fan.
Note: Do a Fault Reset to clear the fault.			

7.4 Fault

Code	Name	Causes	Possible Solutions
FbH	Excessive PID Feedback	The <i>FbH</i> detection level is set incorrectly.	Adjust <i>b5-36</i> [<i>PID High Feedback Detection Lvl</i>] and <i>b5-37</i> [<i>PID High Feedback Detection Time</i>].
		There is a problem with the PID feedback wiring.	Correct errors with the PID control wiring.
		The feedback sensor is not operating correctly.	Examine the sensors on the control device side.
		A fault occurred in the feedback input circuit of the drive.	Replace the control board or the drive. For information about replacing the control board, contact Yaskawa or your nearest sales representative.
Note: <ul style="list-style-type: none"> The drive detects this fault if the PID feedback input is more than the level set in <i>b5-36</i> for longer than <i>b5-37</i>. Do a Fault Reset to clear the fault. If the drive detects this fault, it will operate the motor as specified by the stop method set in <i>b5-12</i> [<i>Feedback Loss Detection Select</i>]. 			
Code	Name	Causes	Possible Solutions
FbL	PID Feedback Loss	The <i>FbL</i> detection level is set incorrectly.	Adjust <i>b5-13</i> [<i>PID Feedback Loss Detection Lvl</i>] and <i>b5-14</i> [<i>PID Feedback Loss Detection Time</i>].
		There is a problem with the PID feedback wiring.	Correct errors with the PID control wiring.
		The feedback sensor is not operating correctly.	Examine the sensors on the control device side.
		A fault occurred in the feedback input circuit of the drive.	Replace the control board or the drive. For information about replacing the control board, contact Yaskawa or your nearest sales representative.
Note: <ul style="list-style-type: none"> The drive detects this fault if the PID feedback input is more than the level set in <i>b5-13</i> for longer than <i>b5-14</i>. Do a Fault Reset to clear the fault. If the drive detects this fault, it will operate the motor as specified by the stop method set in <i>b5-12</i> [<i>Feedback Loss Detection Select</i>]. 			
Code	Name	Causes	Possible Solutions
GF	Ground Fault	Overheating caused damage to the motor or the motor insulation is not satisfactory.	Measure the motor insulation resistance, and replace the motor if there is electrical conduction or unserviceable insulation.
		The motor main circuit cable is contacting ground to make a short circuit.	<ul style="list-style-type: none"> Examine the motor main circuit cable for damage, and repair short circuits. Measure the resistance between the motor main circuit cable and the ground terminal. If there is electrical conduction, replace the cable.
		An increase in the stray capacitance of the cable and the ground terminal caused an increase in the leakage current.	<ul style="list-style-type: none"> If the wiring length of the cable is more than 100 m, decrease the carrier frequency. Decrease the stray capacitance.
		There was a problem with the drive hardware.	Replace the control board or the drive. For information about replacing the control board, contact Yaskawa or your nearest sales representative.
Note: <ul style="list-style-type: none"> The drive detects this fault if a current short to ground was more than 50% of rated current on the output side of the drive. Do a Fault Reset to clear the fault. <i>L5-08</i> [<i>Fault Reset Enable Select Grp2</i>] disables the Auto Restart function. 			
Code	Name	Causes	Possible Solutions
HLCE	High Level Communication Errors	Communication data error occurred between the option and the master drive when you use Gateway function. The master drive detects <i>oFxxx</i> and the slave drive detects <i>HLCE</i> .	Examine the wiring between the option and the master drive and remove the cause of the fault.
Code	Name	Causes	Possible Solutions
LF	Output Phase Loss	The motor main circuit cable is disconnected.	Connect motor main circuit cable wiring. Correct wiring errors in the main circuit drive input power.
		There is a disconnection in the motor coil winding.	If a coil is disconnected, measure the motor Line-to-Line Resistance and replace the motor.
		The screws on the drive output terminals are loose.	Tighten the terminal screws to the correct tightening torque.
		The rated output current of the motor is less than 5% of the drive rated current.	Examine the drive capacity or the motor output to be applied.
		You are trying to use a single-phase motor.	The drive cannot operate a single-phase motor.
		The output transistor in the drive is damaged.	<ul style="list-style-type: none"> Re-energize the drive. If the fault stays, replace the control board or the drive. For information about replacing the control board, contact Yaskawa or your nearest sales representative.
Note: <ul style="list-style-type: none"> The drive detects this fault if phase loss occurs on the output side of the drive. Do a Fault Reset to clear the fault. Set <i>L8-07</i> [<i>Output Phase Loss Protection Sel</i>] to enable and disable <i>LF</i> detection. 			

Code	Name	Causes	Possible Solutions
LF2	Output Current Imbalance	There is phase loss in the wiring on the output side of the drive.	Examine for wiring errors or disconnected wires on the output side of the drive, and repair problems.
		The screws on the drive output terminals are loose.	Tighten the terminal screws to a correct tightening torque.
		There is not balance between the three phases of the PM motor impedance.	<ul style="list-style-type: none"> Measure the Line-to-Line Resistance for each motor phase and make sure that resistance is equal in the three phases, and that all wires are connected correctly. Replace the motor.
		The drive output circuit is broken.	<ul style="list-style-type: none"> Re-energize the drive. If the fault stays, replace the control board or the drive. For information about replacing the control board, contact Yaskawa or your nearest sales representative.
		The voltage compensation-related parameters are incorrect.	Set $C4-20 = 0$ [Voltage Compensation Adjust 1 = 0 Hz].
Note: <ul style="list-style-type: none"> The drive detects this fault if there is not balance between the three phases of the output current from the PM motor. Do a Fault Reset to clear the fault. 			
Code	Name	Causes	Possible Solutions
LSo	Low Speed Motor Step-Out	The motor code set incorrectly.	<ul style="list-style-type: none"> Set $E5-01$ [PM Motor Code Selection] correctly as specified by the motor. For specialized motors, refer to the motor test report and set $E5-xx$ correctly.
		The load is too large.	<ul style="list-style-type: none"> Decrease the load. Replace the drive and motor with larger capacity models.
		An external force on the load side caused the motor to move at start.	Find and repair problems on the load side that cause the motor to rotate from the load side.
		The drive incorrectly detected the motor magnetic pole position.	<ul style="list-style-type: none"> Set $b3-01 = 1$ [Speed Search at Start Selection = Enabled]. If the value for $U6-57$ [PolePolarityDeterVal] is lower than 819, increase the value set in $n8-84$ [Polarity Detection Current]. Consult the motor manufacturer for information about maximum setting values.
		The setting of $n8-84$ [Polarity Detection Current] is too low.	Increase the $n8-84$ setting from the default. Consult the motor manufacturer for information about maximum setting values.
		Incorrect values set in $L8-93$ [Low Speed Pull-out DetectionTime], $L8-94$ [Low Speed Pull-out Detect Level], and $L8-95$ [Low Speed Pull-out Amount].	Increase the values set in $L8-93$ to $L8-95$.
		The drive incorrectly detected the motor magnetic pole position.	If you are using an IPM motor, do High Frequency Injection Auto-Tuning.
Note: <ul style="list-style-type: none"> The drive detects this fault if it detects step-out while running at low speed. Do a Fault Reset to clear the fault. LSo is a protective function that stops the motor and stops the reverse run if a motor without a motor code incorrectly detects the initial polarity. To quickly detect motor reversal, decrease the values set in $L8-93$ to $L8-95$ to a range in which the drive does not malfunction. 			
Code	Name	Causes	Possible Solutions
nSE	Node Setup Error	The $H1-xx = 47$ [Node Setup (CANopen)] terminal was activated during run.	Stop the drive when the Node Setup function is in use.
		The drive received a Run command while the Node Setup function was active.	
Note: <ul style="list-style-type: none"> Do a Fault Reset to clear the fault. 			
Code	Name	Causes	Possible Solutions
oC	Overcurrent	The load is too heavy.	<ul style="list-style-type: none"> Measure the current flowing into the motor. Replace the drive with a larger capacity model if the current value is more than the drive rated current. Decrease the load or replace with a larger drive to prevent sudden changes in the current level.
		Overheating caused damage to the motor or the motor insulation is not satisfactory.	Measure the motor insulation resistance, and replace the motor if there is electrical conduction or unserviceable insulation.
		The motor main circuit cable is contacting ground to make a short circuit.	<ul style="list-style-type: none"> Examine the motor main circuit cable for damage, and repair short circuits. Measure the resistance between the motor main circuit cable and the ground terminal. If there is electrical conduction, replace the cable.
		A short circuit or ground fault on the drive output side caused damage to the output transistor of the drive.	<ul style="list-style-type: none"> Make sure that there is not a short circuit in terminal B1 and terminals U/T1, V/T2, and W/T3. Make sure that there is not a short circuit in terminals - and terminals U/T1, V/T2, and W/T3. If there is a short circuit, contact Yaskawa or your nearest sales representative.

7.4 Fault

Code	Name	Causes	Possible Solutions
		The acceleration time is too short.	<ul style="list-style-type: none"> Calculate the torque necessary during acceleration related to the load inertia and the specified acceleration time. Increase the values set in <i>C1-01</i>, <i>C1-03</i>, <i>C1-05</i>, or <i>C1-07</i> [<i>Acceleration Times</i>] to get the necessary torque. Increase the values set in <i>C2-01</i> to <i>C2-04</i> [<i>S-Curve Characteristics</i>] to get the necessary torque. Replace the drive with a larger capacity model.
		The drive is trying to operate a specialized motor or a motor that is larger than the maximum applicable motor output of the drive.	<ul style="list-style-type: none"> Examine the motor nameplate, the motor, and the drive to make sure that the drive rated current is larger than the motor rated current. Replace the drive with a larger capacity model.
		A magnetic contactor was switched at the output.	Set the operation sequence to not turn ON or OFF the magnetic contactor while the drive is outputting voltage.
		The V/f pattern settings are incorrect.	<ul style="list-style-type: none"> Examine the ratios between the V/f pattern frequency and voltage. Decrease the voltage if it is too high compared to the frequency. Adjust <i>E1-04</i> to <i>E1-10</i> [<i>V/f Pattern Parameters</i>]. For motor 2, adjust <i>E3-04</i> to <i>E3-10</i>.
		The torque compensation gain is too large.	Decrease the value set in <i>C4-01</i> [<i>Torque Compensation Gain</i>] to make sure that the motor does not stall.
		Electrical interference caused a problem.	Examine the control circuit lines, main circuit lines, and ground wiring, and decrease the effects of electrical interference.
		The gain during overexcitation operation is too large.	<ul style="list-style-type: none"> Find the time when the fault occurs. If the fault occurs at the same time as overexcitation operation, decrease the value set in <i>n3-13</i> [<i>OverexcitationBraking (OEB) Gain</i>] and consider the motor flux saturation.
		The drive received a Run command while the motor was coasting.	<ul style="list-style-type: none"> Examine the sequence and input the Run command after the motor fully stops. Set <i>b3-01</i> = 1 [<i>Speed Search at Start Selection = Enabled</i>] or set <i>H1-xx</i> = 61, 62 [<i>Speed Search from Fmax or Fref</i>] to input speed search commands from the MFDI terminals.
		In PM Control Methods, the setting of the motor code is incorrect.	<ul style="list-style-type: none"> Enter the correct motor code to <i>E5-01</i> [<i>PM Motor Code Selection</i>] as specified by the PM motor. For specialized motors, refer to the motor test report and set <i>E5-xx</i> [<i>PM Motor Settings</i>] correctly.
		If the drive detects the fault at start or in the low speed range (10% or less) and <i>n8-57</i> = 1 [<i>HFI Overlap Selection = Enabled</i>] for PM Control methods, the high frequency injection gain is too high.	<ul style="list-style-type: none"> Set <i>E5-xx</i> [<i>PM Motor Parameters</i>] correctly or do Rotational Auto-Tuning. Decrease the value of <i>n8-41</i> [<i>HFI P Gain</i>] in 0.5-unit increments. <p>Note: Set <i>n8-41</i> > 0.0 for IPM motors.</p>
		The current flowing in the motor is more than the value set in <i>L8-27</i> [<i>Overcurrent Detection Gain</i>] for PM Control Methods.	Correct the value set in <i>L8-27</i> .
		The control method is set incorrectly for the motor.	Set <i>A1-02</i> [<i>Control Method Selection</i>] correctly.
		The motor main circuit cable is too long.	Replace the drive with a larger capacity model.
		Speed search does not complete at start when you set <i>A1-02</i> = 8 [<i>EZ Vector Control</i>] and use an induction motor.	When <i>E9-01</i> = 0 [<i>Motor Type Selection = Induction (IM)</i>], set <i>b3-24</i> = 2 [<i>Speed Search Method Selection = Current Detection Speed Search</i>].
		An overcurrent occurred during overexcitation deceleration.	<ul style="list-style-type: none"> Decrease the value set in <i>n3-13</i> [<i>OverexcitationBraking (OEB) Gain</i>]. Decrease the value set in <i>n3-21</i> [<i>HSB Current Suppression Level</i>].
		When you use an IE3 premium efficiency motor.	<p>Use these values to adjust the parameters.</p> <ul style="list-style-type: none"> <i>b3-03</i> [<i>Speed Search Deceleration Time</i>] = default value × 2 <i>L2-03</i> [<i>Minimum Baseblock Time</i>] = default value × 2 <i>L2-04</i> [<i>Powerloss V/f Recovery Ramp Time</i>] = default value × 2
<p>Note:</p> <ul style="list-style-type: none"> This fault occurs if the drive sensors detect a drive output current more than the specified overcurrent detection level. Do a Fault Reset to clear the fault. 			
Code	Name	Causes	Possible Solutions
oFA00	Option Not Compatible with Port	The option connected to connector CN5-A is not compatible.	<p>Connect the option to the correct connector.</p> <p>Note: Encoder options are not compatible with connector CN5-A.</p>
<p>Note:</p> <ul style="list-style-type: none"> Do a Fault Reset to clear the fault. Fault trace is not available for these faults. 			

Code	Name	Causes	Possible Solutions
oFA01	Option Fault/Connection Error	The option card connected to connector CN5-A is not compatible.	<ol style="list-style-type: none"> 1. De-energize the drive. 2. Refer to the option card manual and correctly connect the option card to the connector on the drive.
Note: Do a Fault Reset to clear the fault.			
Code	Name	Causes	Possible Solutions
oFA02	Duplicate Options	The same option cards or the same type of option cards are connected to connectors CN5-A, B, and C.	Connect the option card to the correct connector. Note: Use connectors CN5-C and CN5-B to connect two encoder option cards.
Note: Do a Fault Reset to clear the fault.			
Code	Name	Causes	Possible Solutions
oFA03	Diagnostic Error	A fault occurred in the option card.	<ol style="list-style-type: none"> 1. De-energize the drive. 2. Make sure that the option card is correctly connected to the connector. 3. If the problem continues, replace the option card.
Note: Do a Fault Reset to clear the fault.			
Code	Name	Causes	Possible Solutions
oFA04	Flash Write Mode	A fault occurred in the option card.	<ol style="list-style-type: none"> 1. De-energize the drive. 2. Make sure that the option card is correctly connected to the connector. 3. If the problem continues, replace the option card.
Note: Do a Fault Reset to clear the fault.			
Code	Name	Causes	Possible Solutions
oFA05	Option A/D Error	A fault occurred in the option card.	<ol style="list-style-type: none"> 1. De-energize the drive. 2. Make sure that the option card is correctly connected to the connector. 3. If the problem continues, replace the option card.
Note: Do a Fault Reset to clear the fault.			
Code	Name	Causes	Possible Solutions
oFA06	Option Communication Error	A fault occurred in the option card.	<ol style="list-style-type: none"> 1. De-energize the drive. 2. Make sure that the option card is correctly connected to the connector. 3. If the problem continues, replace the option card.
Note: Do a Fault Reset to clear the fault.			
Code	Name	Causes	Possible Solutions
oFA10	Option RAM Error	A fault occurred in the option card.	<ol style="list-style-type: none"> 1. De-energize the drive. 2. Make sure that the option card is correctly connected to the connector. 3. If the problem continues, replace the option card.
Note: Do a Fault Reset to clear the fault.			
Code	Name	Causes	Possible Solutions
oFA11	Option Ope Mode Error	A fault occurred in the option card.	<ol style="list-style-type: none"> 1. De-energize the drive. 2. Make sure that the option card is correctly connected to the connector. 3. If the problem continues, replace the option card.
Note: Do a Fault Reset to clear the fault.			
Code	Name	Causes	Possible Solutions
oFA12	Drive Receive CRC Error	A fault occurred in the option card.	<ol style="list-style-type: none"> 1. De-energize the drive. 2. Make sure that the option card is correctly connected to the connector. 3. If the problem continues, replace the option card.
Note: Do a Fault Reset to clear the fault.			

7.4 Fault

Code	Name	Causes	Possible Solutions
oFA13	Drive Receive Frame Error	A fault occurred in the option card.	<ol style="list-style-type: none"> 1. De-energize the drive. 2. Make sure that the option card is correctly connected to the connector. 3. If the problem continues, replace the option card.
Note: Do a Fault Reset to clear the fault.			
Code	Name	Causes	Possible Solutions
oFA14	Drive Receive Abort Error	A fault occurred in the option card.	<ol style="list-style-type: none"> 1. De-energize the drive. 2. Make sure that the option card is correctly connected to the connector. 3. If the problem continues, replace the option card.
Note: Do a Fault Reset to clear the fault.			
Code	Name	Causes	Possible Solutions
oFA15	Option Receive CRC Error	A fault occurred in the option card.	<ol style="list-style-type: none"> 1. De-energize the drive. 2. Make sure that the option card is correctly connected to the connector. 3. If the problem continues, replace the option card.
Note: Do a Fault Reset to clear the fault.			
Code	Name	Causes	Possible Solutions
oFA16	Option Receive Frame Error	A fault occurred in the option card.	<ol style="list-style-type: none"> 1. De-energize the drive. 2. Make sure that the option card is correctly connected to the connector. 3. If the problem continues, replace the option card.
Note: Do a Fault Reset to clear the fault.			
Code	Name	Causes	Possible Solutions
oFA17	Option Receive Abort Error	A fault occurred in the option card.	<ol style="list-style-type: none"> 1. De-energize the drive. 2. Make sure that the option card is correctly connected to the connector. 3. If the problem continues, replace the option card.
Note: Do a Fault Reset to clear the fault.			
Code	Name	Causes	Possible Solutions
oFA30	COM ID Error	A fault occurred in the option card.	<ol style="list-style-type: none"> 1. De-energize the drive. 2. Make sure that the option card is correctly connected to the connector. 3. If the problem continues, replace the option card.
Note: Do a Fault Reset to clear the fault.			
Code	Name	Causes	Possible Solutions
oFA31	Type Code Error	A fault occurred in the option card.	<ol style="list-style-type: none"> 1. De-energize the drive. 2. Make sure that the option card is correctly connected to the connector. 3. If the problem continues, replace the option card.
Note: Do a Fault Reset to clear the fault.			
Code	Name	Causes	Possible Solutions
oFA32	SUM Check Error	A fault occurred in the option card.	<ol style="list-style-type: none"> 1. De-energize the drive. 2. Make sure that the option card is correctly connected to the connector. 3. If the problem continues, replace the option card.
Note: Do a Fault Reset to clear the fault.			
Code	Name	Causes	Possible Solutions
oFA33	Option Receive Time Over	A fault occurred in the option card.	<ol style="list-style-type: none"> 1. De-energize the drive. 2. Make sure that the option card is correctly connected to the connector. 3. If the problem continues, replace the option card.
Note: Do a Fault Reset to clear the fault.			

Code	Name	Causes	Possible Solutions
oFA34	Memobus Time Over	A fault occurred in the option card.	<ol style="list-style-type: none"> 1. De-energize the drive. 2. Make sure that the option card is correctly connected to the connector. 3. If the problem continues, replace the option card.
Note: Do a Fault Reset to clear the fault.			
Code	Name	Causes	Possible Solutions
oFA35	Drive Receive Time Over 1	A fault occurred in the option card.	<ol style="list-style-type: none"> 1. De-energize the drive. 2. Make sure that the option card is correctly connected to the connector. 3. If the problem continues, replace the option card.
Note: Do a Fault Reset to clear the fault.			
Code	Name	Causes	Possible Solutions
oFA36	CI Check Error	A fault occurred in the option card.	<ol style="list-style-type: none"> 1. De-energize the drive. 2. Make sure that the option card is correctly connected to the connector. 3. If the problem continues, replace the option card.
Note: Do a Fault Reset to clear the fault.			
Code	Name	Causes	Possible Solutions
oFA37	Drive Receive Time Over 2	A fault occurred in the option card.	<ol style="list-style-type: none"> 1. De-energize the drive. 2. Make sure that the option card is correctly connected to the connector. 3. If the problem continues, replace the option card.
Note: Do a Fault Reset to clear the fault.			
Code	Name	Causes	Possible Solutions
oFA38	Control Reference Error	A fault occurred in the option card.	<ol style="list-style-type: none"> 1. De-energize the drive. 2. Make sure that the option card is correctly connected to the connector. 3. If the problem continues, replace the option card.
Note: Do a Fault Reset to clear the fault.			
Code	Name	Causes	Possible Solutions
oFA39	Drive Receive Time Over 3	A fault occurred in the option card.	<ol style="list-style-type: none"> 1. De-energize the drive. 2. Make sure that the option card is correctly connected to the connector. 3. If the problem continues, replace the option card.
Note: Do a Fault Reset to clear the fault.			
Code	Name	Causes	Possible Solutions
oFA40	CtrlResSel 1Err	A fault occurred in the option card.	<ol style="list-style-type: none"> 1. De-energize the drive. 2. Make sure that the option card is correctly connected to the connector. 3. If the problem continues, replace the option card.
Note: Do a Fault Reset to clear the fault.			
Code	Name	Causes	Possible Solutions
oFA41	Drive Receive Time Over 4	A fault occurred in the option card.	<ol style="list-style-type: none"> 1. De-energize the drive. 2. Make sure that the option card is correctly connected to the connector. 3. If the problem continues, replace the option card.
Note: Do a Fault Reset to clear the fault.			
Code	Name	Causes	Possible Solutions
oFA42	CtrlResSel 2Err	A fault occurred in the option card.	<ol style="list-style-type: none"> 1. De-energize the drive. 2. Make sure that the option card is correctly connected to the connector. 3. If the problem continues, replace the option card.
Note: Do a Fault Reset to clear the fault.			

7.4 Fault

Code	Name	Causes	Possible Solutions
oFA43	Drive Receive Time Over 5	A fault occurred in the option card.	<ol style="list-style-type: none"> 1. De-energize the drive. 2. Make sure that the option card is correctly connected to the connector. 3. If the problem continues, replace the option card.
Note: Do a Fault Reset to clear the fault.			
Code	Name	Causes	Possible Solutions
oFb00	Option Not Compatible with Port	The option connected to connector CN5-B is not compatible.	Connect the option to the correct connector. Note: DO-A3, AO-A3, PG-B3, and PG-X3 options can connect to connector CN5-B. To connect only one PG option card, use the CN5-C connector.
Note: <ul style="list-style-type: none"> • Do a Fault Reset to clear the fault. • Fault trace is not available for these faults. 			
Code	Name	Causes	Possible Solutions
oFb01	Option Fault/Connection Error	The option card connected to connector CN5-B was changed during operation.	<ol style="list-style-type: none"> 1. De-energize the drive. 2. Refer to the option card manual and correctly connect the option card to the connector on the drive.
Note: Do a Fault Reset to clear the fault.			
Code	Name	Causes	Possible Solutions
oFb02	Duplicate Options	The same option cards or the same type of option cards are connected to connectors CN5-A, B, and C.	Connect the option card to the correct connector.
Note: Do a Fault Reset to clear the fault.			
Code	Name	Causes	Possible Solutions
oFb03	Diagnostic Error	A fault occurred in the option card.	<ol style="list-style-type: none"> 1. De-energize the drive. 2. Make sure that the option card is correctly connected to the connector. 3. If the problem continues, replace the option card.
Note: Do a Fault Reset to clear the fault.			
Code	Name	Causes	Possible Solutions
oFb04	Flash Write Mode	A fault occurred in the option card.	<ol style="list-style-type: none"> 1. De-energize the drive. 2. Make sure that the option card is correctly connected to the connector. 3. If the problem continues, replace the option card.
Note: Do a Fault Reset to clear the fault.			
Code	Name	Causes	Possible Solutions
oFb05	Option A/D Error	A fault occurred in the option card.	<ol style="list-style-type: none"> 1. De-energize the drive. 2. Make sure that the option card is correctly connected to the connector. 3. If the problem continues, replace the option card.
Note: Do a Fault Reset to clear the fault.			
Code	Name	Causes	Possible Solutions
oFb06	Option Communication Error	A fault occurred in the option card.	<ol style="list-style-type: none"> 1. De-energize the drive. 2. Make sure that the option card is correctly connected to the connector. 3. If the problem continues, replace the option card.
Note: Do a Fault Reset to clear the fault.			
Code	Name	Causes	Possible Solutions
oFb10	Option RAM Error	A fault occurred in the option card.	<ol style="list-style-type: none"> 1. De-energize the drive. 2. Make sure that the option card is correctly connected to the connector. 3. If the problem continues, replace the option card.
Note: Do a Fault Reset to clear the fault.			

Code	Name	Causes	Possible Solutions
oFb11	Option Opn Mode Error	A fault occurred in the option card.	<ol style="list-style-type: none"> De-energize the drive. Make sure that the option card is correctly connected to the connector. If the problem continues, replace the option card.
Note: Do a Fault Reset to clear the fault.			
Code	Name	Causes	Possible Solutions
oFb12	Drive Receive CRC Error	A fault occurred in the option card.	<ol style="list-style-type: none"> De-energize the drive. Make sure that the option card is correctly connected to the connector. If the problem continues, replace the option card.
Note: Do a Fault Reset to clear the fault.			
Code	Name	Causes	Possible Solutions
oFb13	Drive Receive Frame Error	A fault occurred in the option card.	<ol style="list-style-type: none"> De-energize the drive. Make sure that the option card is correctly connected to the connector. If the problem continues, replace the option card.
Note: Do a Fault Reset to clear the fault.			
Code	Name	Causes	Possible Solutions
oFb14	Drive Receive Abort Error	A fault occurred in the option card.	<ol style="list-style-type: none"> De-energize the drive. Make sure that the option card is correctly connected to the connector. If the problem continues, replace the option card.
Note: Do a Fault Reset to clear the fault.			
Code	Name	Causes	Possible Solutions
oFb15	Option Receive CRC Error	A fault occurred in the option card.	<ol style="list-style-type: none"> De-energize the drive. Make sure that the option card is correctly connected to the connector. If the problem continues, replace the option card.
Note: Do a Fault Reset to clear the fault.			
Code	Name	Causes	Possible Solutions
oFb16	Option Receive Frame Error	A fault occurred in the option card.	<ol style="list-style-type: none"> De-energize the drive. Make sure that the option card is correctly connected to the connector. If the problem continues, replace the option card.
Note: Do a Fault Reset to clear the fault.			
Code	Name	Causes	Possible Solutions
oFb17	Option Receive Abort Error	A fault occurred in the option card.	<ol style="list-style-type: none"> De-energize the drive. Make sure that the option card is correctly connected to the connector. If the problem continues, replace the option card.
Note: Do a Fault Reset to clear the fault.			
Code	Name	Causes	Possible Solutions
oFC00	Option Not Compatible with Port	The option connected to connector CN5-C is not compatible.	<p>Connect the option to the correct connector.</p> <p>Note: AI-A3, DI-A3, and communication options cannot be connected to the CN5-C connector.</p>
Note: • Do a Fault Reset to clear the fault. • Fault trace is not available for these faults.			
Code	Name	Causes	Possible Solutions
oFC01	Option Fault/Connection Error	The option card connected to connector CN5-C was changed during operation.	<ol style="list-style-type: none"> De-energize the drive. Refer to the option card manual and correctly connect the option card to the connector on the drive.
Note: Do a Fault Reset to clear the fault.			

7.4 Fault

Code	Name	Causes	Possible Solutions
oFC02	Duplicate Options	The same option cards or the same type of option cards are connected to connectors CN5-A, B, and C.	Connect the option card to the correct connector.
Note: Do a Fault Reset to clear the fault.			
Code	Name	Causes	Possible Solutions
oFC03	Diagnostic Error	A fault occurred in the option card.	<ol style="list-style-type: none"> 1. De-energize the drive. 2. Make sure that the option card is correctly connected to the connector. 3. If the problem continues, replace the option card.
Note: Do a Fault Reset to clear the fault.			
Code	Name	Causes	Possible Solutions
oFC04	Flash Write Mode	A fault occurred in the option card.	<ol style="list-style-type: none"> 1. De-energize the drive. 2. Make sure that the option card is correctly connected to the connector. 3. If the problem continues, replace the option card.
Note: Do a Fault Reset to clear the fault.			
Code	Name	Causes	Possible Solutions
oFC05	Option A/D Error	A fault occurred in the option card.	<ol style="list-style-type: none"> 1. De-energize the drive. 2. Make sure that the option card is correctly connected to the connector. 3. If the problem continues, replace the option card.
Note: Do a Fault Reset to clear the fault.			
Code	Name	Causes	Possible Solutions
oFC06	Option Card Error Occurred at Option Port (CN5-C)	A fault occurred in the option.	<ol style="list-style-type: none"> 1. De-energize the drive. 2. Make sure that the option is correctly connected to the connector. 3. Re-energize the drive. If the problem continues, replace the option.
		You re-energized the drive when: <ul style="list-style-type: none"> • There is an encoder option installed the drive • The drive main circuit power supply is energized • There is an external 24 V power supply connected to terminals PS-AC. 	<ol style="list-style-type: none"> 1. De-energize the drive main circuit power supply and the external 24 V power supply to terminals PS-AC. 2. After the keypad display goes out, energize the drive main circuit power supply again. 3. Supply the external 24 V power to terminals PS-AC.
			When you use an encoder, de-energize the drive main circuit power supply.
Note: Do a Fault Reset to clear the fault.			
Code	Name	Causes	Possible Solutions
oFC10	Option RAM Error	A fault occurred in the option card.	<ol style="list-style-type: none"> 1. De-energize the drive. 2. Make sure that the option card is correctly connected to the connector. 3. If the problem continues, replace the option card.
Note: Do a Fault Reset to clear the fault.			
Code	Name	Causes	Possible Solutions
oFC11	Option Ope Mode Error	A fault occurred in the option card.	<ol style="list-style-type: none"> 1. De-energize the drive. 2. Make sure that the option card is correctly connected to the connector. 3. If the problem continues, replace the option card.
Note: Do a Fault Reset to clear the fault.			
Code	Name	Causes	Possible Solutions
oFC12	Drive Receive CRC Error	A fault occurred in the option card.	<ol style="list-style-type: none"> 1. De-energize the drive. 2. Make sure that the option card is correctly connected to the connector. 3. If the problem continues, replace the option card.
Note: Do a Fault Reset to clear the fault.			

Code	Name	Causes	Possible Solutions
oFC13	Drive Receive Frame Error	A fault occurred in the option card.	<ol style="list-style-type: none"> 1. De-energize the drive. 2. Make sure that the option card is correctly connected to the connector. 3. If the problem continues, replace the option card.
Note: Do a Fault Reset to clear the fault.			
Code	Name	Causes	Possible Solutions
oFC14	Drive Receive Abort Error	A fault occurred in the option card.	<ol style="list-style-type: none"> 1. De-energize the drive. 2. Make sure that the option card is correctly connected to the connector. 3. If the problem continues, replace the option card.
Note: Do a Fault Reset to clear the fault.			
Code	Name	Causes	Possible Solutions
oFC15	Option Receive CRC Error	A fault occurred in the option card.	<ol style="list-style-type: none"> 1. De-energize the drive. 2. Make sure that the option card is correctly connected to the connector. 3. If the problem continues, replace the option card.
Note: Do a Fault Reset to clear the fault.			
Code	Name	Causes	Possible Solutions
oFC16	Option Receive Frame Error	A fault occurred in the option card.	<ol style="list-style-type: none"> 1. De-energize the drive. 2. Make sure that the option card is correctly connected to the connector. 3. If the problem continues, replace the option card.
Note: Do a Fault Reset to clear the fault.			
Code	Name	Causes	Possible Solutions
oFC17	Option Receive Abort Error	A fault occurred in the option card.	<ol style="list-style-type: none"> 1. De-energize the drive. 2. Make sure that the option card is correctly connected to the connector. 3. If the problem continues, replace the option card.
Note: Do a Fault Reset to clear the fault.			
Code	Name	Causes	Possible Solutions
oFC50	EncOp A/D CnvErr	A fault occurred in the option card.	Refer to the manual for the PG-RT3 or PG-F3 option card.
Note: Do a Fault Reset to clear the fault.			
Code	Name	Causes	Possible Solutions
oFC51	EncOpAnlgCrcErr	A fault occurred in the option card.	Refer to the manual for the PG-RT3 or PG-F3 option card.
Note: Do a Fault Reset to clear the fault.			
Code	Name	Causes	Possible Solutions
oFC52	Enc Com Timeout	A fault occurred in the option card.	Refer to the manual for the PG-RT3 or PG-F3 option card.
Note: Do a Fault Reset to clear the fault.			
Code	Name	Causes	Possible Solutions
oFC53	Enc Com Data Flt	A fault occurred in the option card.	Refer to the manual for the PG-RT3 or PG-F3 option card.
Note: Do a Fault Reset to clear the fault.			
Code	Name	Causes	Possible Solutions
oFC54	Encoder Error	A fault occurred in the option card.	Refer to the manual for the PG-RT3 or PG-F3 option card.
Note: Do a Fault Reset to clear the fault.			
Code	Name	Causes	Possible Solutions
oFC55	Resolver Error	A fault occurred in the option card.	Refer to the manual for the PG-RT3 or PG-F3 option card.
Note: Do a Fault Reset to clear the fault.			

7.4 Fault

Code	Name	Causes	Possible Solutions
oH	Heatsink Overheat	The ambient temperature is high and the heatsink temperature of the drive is more than the value set in L8-02 [Overheat Alarm Level].	<ul style="list-style-type: none"> Measure the ambient temperature. Increase the airflow in the control panel. Install a cooling device (cooling fan or air conditioner) to lower the ambient temperature. Remove objects near the drive that are producing too much heat.
		The load is too heavy.	<ul style="list-style-type: none"> Measure the output current. Decrease the load. Decrease the value set in C6-02 [Carrier Frequency Selection].
		The internal cooling fan of the drive stopped.	<ol style="list-style-type: none"> Use the procedures in this manual to replace the cooling fan. Set o4-03 = 0 [Fan Operation Time Setting = 0 h].
<p>Note:</p> <ul style="list-style-type: none"> The drive detects this fault if the heatsink temperature of the drive is more than the value set in L8-02. Do a Fault Reset to clear the fault. If the drive detects this fault, it will operate the motor as specified by the Stopping Method set in L8-03 [Overheat Pre-Alarm Selection]. 			
Code	Name	Causes	Possible Solutions
oH1	Heatsink Overheat	The ambient temperature is high and the heatsink temperature of the drive is more than the oH1 detection level.	<ul style="list-style-type: none"> Measure the ambient temperature. Increase the airflow in the control panel. Install a cooling device (cooling fan or air conditioner) to lower the ambient temperature. Remove objects near the drive that are producing too much heat.
		The load is too heavy.	<ul style="list-style-type: none"> Measure the output current. Decrease the load. Decrease the value set in C6-02 [Carrier Frequency Selection].
<p>Note:</p> <ul style="list-style-type: none"> The drive detects this fault if the heatsink temperature of the drive is more than the oH1 detection level. o2-04 [Drive Model (KVA) Selection] determines the oH1 detection level. Do a Fault Reset to clear the fault. L5-08 [Fault Reset Enable Select Grp2] disables the Auto Restart function. 			
Code	Name	Causes	Possible Solutions
oH3	Motor Overheat (PTC Input)	The thermistor wiring that detects motor temperature is defective.	Correct wiring errors.
		A fault occurred on the machine. Example: The machine is locked.	Examine the machine and remove the cause of the fault
		The motor has overheated.	<ul style="list-style-type: none"> Check the load level, acceleration/deceleration time, and motor start/stop frequency (cycle time). Decrease the load. Increase the values set in C1-01 to C1-08 [Acceleration/Deceleration Times]. Set E2-01 [Motor Rated Current (FLA)] correctly to the value specified by the motor nameplate. Make sure that the motor cooling system is operating correctly, and repair or replace it if it is damaged. Adjust E1-04 to E1-10 [V/f Pattern Parameters]. For motor 2, adjust E3-04 to E3-10. Decrease the values set in E1-08 [Mid Point A Voltage] and E1-10 [Minimum Output Voltage]. <p>Note:</p> <p>If the values set in E1-08 and E1-10 are too low, the overload tolerance will decrease at low speeds.</p>
<p>Note:</p> <ul style="list-style-type: none"> When H3-02, H3-10, or H3-06 = E [MFAI Function Selection = Motor Temperature (PTC Input)], the drive detects this fault if the motor overheat signal entered to an analog input terminal A1, A2, or A3 is more than the alarm detection level. Do a Fault Reset to clear the fault. If the drive detects this fault, it will operate the motor as specified by the Stopping Method set in L1-03 [Motor Thermistor oH Alarm Select]. 			

Code	Name	Causes	Possible Solutions
oH4	Motor Overheat Fault (PTC Input)	The motor has overheated.	<ul style="list-style-type: none"> Check the load level, acceleration/deceleration time, and motor start/stop frequency (cycle time). Decrease the load. Increase the values set in C1-01 to C1-08 [Acceleration/Deceleration Times]. Set E2-01 [Motor Rated Current (FLA)] correctly to the value specified by the motor nameplate. Make sure that the motor cooling system is operating correctly, and repair or replace it if it is damaged. Adjust E1-04 to E1-10 [V/f Pattern Parameters]. For motor 2, adjust E3-04 to E3-10. Decrease the values set in E1-08 [Mid Point A Voltage] and E1-10 [Minimum Output Voltage]. <p>Note: If the values set in E1-08 and E1-10 are too low, the overload tolerance will decrease at low speeds.</p>
<p>Note:</p> <ul style="list-style-type: none"> When H3-02, H3-10, or H3-06 = E [MFAI Function Selection = Motor Temperature (PTC Input)], the drive detects this fault if the motor overheat signal entered to an analog input terminal A1, A2, or A3 is more than the alarm detection level. Do a Fault Reset to clear the fault. 			
Code	Name	Causes	Possible Solutions
oL1	Motor Overload	The load is too heavy.	Decrease the load. <p>Note: Reset oL1 when U4-16 [Motor oL1 Level] < 100.</p>
		The acceleration/deceleration times or cycle times are too short.	<ul style="list-style-type: none"> Examine the acceleration/deceleration times and the motor start/stop frequencies (cycle times). Increase the values set in C1-01 to C1-08 [Acceleration/Deceleration Times].
		Overload occurred while running at low speed.	<ul style="list-style-type: none"> Decrease the load when running at low speed. Increase the motor speed. If the motor is run frequently at low speeds, replace the motor with a larger motor or use a drive-dedicated motor. <p>Note: For general-purpose motors, overload can occur while running at low speed when operating at below the rated current.</p>
		L1-01 [Motor Overload (oL1) Protection] is set incorrectly.	Set L1-01 in as specified by the motor qualities for a drive-dedicated motor.
		The V/f pattern does not fit the motor qualities.	<ul style="list-style-type: none"> Examine the ratios between the V/f pattern frequency and voltage. Decrease the voltage if it is too high compared to the frequency. Adjust E1-04 to E1-10 [V/f Pattern Parameters]. For motor 2, adjust E3-04 to E3-10. Decrease the values set in E1-08 [Mid Point A Voltage] and E1-10 [Minimum Output Voltage]. <p>Note: If the values set in E1-08 and E1-10 are too low, the overload tolerance will decrease at low speeds.</p>
		E1-06 [Base Frequency] is set incorrectly.	Set E1-06 to the rated frequency shown on the motor nameplate.
		One drive is operating more than one motor.	Set L1-01 = 0 [Motor Overload (oL1) Protection = Disabled], connect thermal overload relay to each motor to prevent damage to the motor.
		The electronic thermal protector qualities and the motor overload properties do not align.	<ul style="list-style-type: none"> Examine the motor qualities and set L1-01 [Motor Overload (oL1) Protection] correctly. Connect a thermal overload relay to the motor.
		The electronic thermal protector is operating at an incorrect level.	Set E2-01 [Motor Rated Current (FLA)] correctly to the value specified by the motor nameplate.
		There is increased motor loss from overexcitation operation.	<ul style="list-style-type: none"> Lower the value set in n3-13 [OverexcitationBraking (OEB) Gain]. Set L3-04 ≠ 4 [Stall Prevention during Decel ≠ Overexcitation/High Flux]. Set n3-23 = 0 [Overexcitation Braking Operation = Disabled].
		The speed search-related parameters are set incorrectly.	<ul style="list-style-type: none"> Examine the settings for all speed search related parameters. Adjust b3-03 [Speed Search Deceleration Time]. Set b3-24 = 1 [Speed Search Method Selection = Speed Estimation] after Auto-Tuning.
Phase loss in the input power supply is causing the output current to change.	Make sure that there is no phase loss, and repair problems.		
Overload occurred during overexcitation deceleration.	<ul style="list-style-type: none"> Decrease the value set in n3-13 [OverexcitationBraking (OEB) Gain]. Decrease the value set in n3-21 [HSB Current Suppression Level]. 		
<p>Note:</p> <ul style="list-style-type: none"> The drive detects this fault if the electronic thermal protector of the drive started the motor overload protection. Do a Fault Reset to clear the fault. L5-07 [Fault Reset Enable Select Grp1] disables the Auto Restart function. 			

7.4 Fault

Code	Name	Causes	Possible Solutions
oL2	Drive Overload	The load is too large.	Decrease the load.
		The acceleration/deceleration times or cycle times are too short.	<ul style="list-style-type: none"> Examine the acceleration/deceleration times and the motor start/stop frequencies (cycle times). Increase the values set in C1-01 to C1-08 [Acceleration/Deceleration Times].
		The V/f pattern does not fit the motor qualities.	<ul style="list-style-type: none"> Examine the ratios between the V/f pattern frequency and voltage. Decrease the voltage if it is too high compared to the frequency. Adjust E1-04 to E1-10 [V/f Pattern Parameters]. Decrease the values set in E1-08 [Mid Point A Voltage] and E1-10 [Minimum Output Voltage]. For motor 2, adjust E3-04 to E3-10. <p>Note: If the values set in E1-08 and E1-10 are too low, the overload tolerance will decrease at low speeds.</p>
		The drive capacity is too small.	Replace the drive with a larger capacity model.
		Overload occurred while running at low speed.	<ul style="list-style-type: none"> Decrease the load when running at low speed. Replace the drive with a larger capacity model. Decrease the value set in C6-02 [Carrier Frequency Selection].
		The torque compensation gain is too large.	Decrease the value set in C4-01 [Torque Compensation Gain] to make sure that the motor does not stall.
		The speed search-related parameters are set incorrectly.	<ul style="list-style-type: none"> Examine the settings for all speed search-related parameters. Adjust b3-03 [Speed Search Deceleration Time]. Set b3-24 = 1 [Speed Search Method Selection = Speed Estimation] after Auto-Tuning.
		Phase loss in the input power supply is causing the output current to change.	<ul style="list-style-type: none"> Correct errors with the wiring for main circuit drive input power. Make sure that there is no phase loss, and repair problems.
	Overload occurred during overexcitation deceleration.	<ul style="list-style-type: none"> Decrease the value set in n3-13 [OverexcitationBraking (OEB) Gain]. Decrease the value set in n3-21 [HSB Current Suppression Level]. 	
<p>Note:</p> <ul style="list-style-type: none"> The drive detects this fault if the electronic thermal protector of the drive started the drive overload protection. Do a Fault Reset to clear the fault. L5-07 [Fault Reset Enable Select Grp1] disables the Auto Restart function. 			
Code	Name	Causes	Possible Solutions
oL3	Overtorque Detection 1	A fault occurred on the machine. Example: The machine is locked.	Examine the machine and remove the cause of the fault.
		The parameters are incorrect for the load.	Adjust L6-02 [Torque Detection Level 1] and L6-03 [Torque Detection Time 1] settings.
<p>Note:</p> <ul style="list-style-type: none"> The drive detects this fault if the drive output current is more than the level set in L6-02 for longer than L6-03. Do a Fault Reset to clear the fault. If the drive detects this fault, it will operate the motor as specified by the Stopping Method set in L6-01 [Torque Detection Selection 1]. L5-07 [Fault Reset Enable Select Grp1] disables the Auto Restart function. 			
Code	Name	Causes	Possible Solutions
oL4	Overtorque Detection 2	A fault occurred on the machine. Example: The machine is locked.	Examine the machine and remove the cause of the fault.
		The parameters are incorrect for the load.	Adjust L6-05 [Torque Detection Level 2] and L6-06 [Torque Detection Time 2] settings.
<p>Note:</p> <ul style="list-style-type: none"> The drive detects this fault if the drive output current is more than the level set in L6-05 for longer than L6-06. Do a Fault Reset to clear the fault. If the drive detects this fault, it will operate the motor as specified by the Stopping Method set in L6-04 [Torque Detection Selection 2]. L5-07 [Fault Reset Enable Select Grp1] disables the Auto Restart function. 			
Code	Name	Causes	Possible Solutions
oL5	Mechanical Weakening Detection 1	The drive detected overtorque as specified by the conditions for mechanical weakening detection set in L6-08 [Mechanical Fatigue Detect Select].	Do a deterioration diagnostic test on the machine side.
<p>Note:</p> <ul style="list-style-type: none"> Do a Fault Reset to clear the fault. If the drive detects this fault, it will operate the motor as specified by the Stopping Method set in L6-08. 			

Code	Name	Causes	Possible Solutions
oL7	High Slip Braking Overload	The load inertia is too large.	<ul style="list-style-type: none"> Decrease deceleration times in <i>C1-02</i>, <i>C1-04</i>, <i>C1-06</i>, and <i>C1-08</i> [<i>Deceleration Times</i>] for applications that do not use High Slip Braking. Use a braking resistor to decrease the deceleration time.
		An external force on the load side rotated the motor.	
		Something is preventing deceleration on the load side.	<ul style="list-style-type: none"> Increase the value set in <i>n3-04</i>. Connect a thermal overload relay to the motor, and set <i>n3-04</i> = 1200 s (maximum value).
		The value set in <i>n3-04</i> [<i>HSB Overload Time</i>] is too small.	
Note: <ul style="list-style-type: none"> The drive detects this fault if the output frequency is constant for longer than <i>n3-04</i>. Do a Fault Reset to clear the fault. 			
Code	Name	Causes	Possible Solutions
oPr	Keypad Connection Fault	The keypad is not securely connected to the connector on the drive.	Examine the connection between the keypad and the drive.
		The connection cable between the drive and the keypad is disconnected.	<ul style="list-style-type: none"> Remove the keypad and then reconnect it. Replace the cable if damaged.
Note: <ul style="list-style-type: none"> The drive detects this fault if these conditions are correct: <ul style="list-style-type: none"> <i>-o2-06</i> = 1 [<i>Keypad Disconnect Detection = Enabled</i>]. <i>-b1-02</i> = 0 [<i>Run Command Selection 1 = Keypad</i>], or the drive is operating in LOCAL Mode with the keypad. Do a Fault Reset to clear the fault. 			
Code	Name	Causes	Possible Solutions
oS	Overspeed	There is overshoot.	<ul style="list-style-type: none"> Decrease <i>C5-01</i> [<i>ASR Proportional Gain 1</i>] and increase <i>C5-02</i> [<i>ASR Integral Time 1</i>]. Adjust the pulse train gain with <i>H6-02</i> to <i>H6-05</i> [<i>Pulse Train Input Setting Parameters</i>].
		There is an incorrect number of PG pulses set in the drive.	Set <i>H6-02</i> [<i>Terminal RP Frequency Scaling</i>] to the pulse train frequency during 100% reference (maximum motor rotation speed).
		The oS detection level is set incorrectly.	Adjust <i>F1-08</i> [<i>Overspeed Detection Level</i>] and <i>F1-09</i> [<i>Overspeed Detection Delay Time</i>].
		If the drive detects the fault at start or in the low speed range (10% or less) and <i>n8-57</i> = 1 [<i>HFI Overlap Selection = Enabled</i>] for PM Control methods, the high frequency injection gain is too high.	<ul style="list-style-type: none"> Set <i>E5-xx</i> [<i>PM Motor Parameters</i>] correctly or do Rotational Auto-Tuning. Decrease the value of <i>n8-41</i> [<i>HFI P Gain</i>] in 0.5 unit increments. Note: Set <i>n8-41</i> > 0.0 for IPM motors.
Note: <ul style="list-style-type: none"> The drive detects this fault if the motor speed is more than the value set in <i>F1-08</i> for longer than <i>F1-09</i>. Do a Fault Reset to clear the fault. If the drive detects this fault, it will operate the motor as specified by the Stopping Method set in <i>F1-03</i> [<i>Overspeed Detection Selection</i>]. 			
Code	Name	Causes	Possible Solutions
ov	Overvoltage	The deceleration time is too short and too much regenerative energy is flowing back into the drive.	<ul style="list-style-type: none"> Set <i>L3-04</i> = 1 [<i>Stall Prevention during Decel = General Purpose</i>]. Increase the values set in <i>C1-02</i>, <i>C1-04</i>, <i>C1-06</i>, or <i>C1-08</i> [<i>Deceleration Times</i>]. Connect a dynamic braking option to the drive. Perform Deceleration Rate Tuning.
		The acceleration time is too short.	<ul style="list-style-type: none"> Make sure that sudden drive acceleration does not cause the fault. Increase the values set in <i>C1-01</i>, <i>C1-03</i>, <i>C1-05</i>, or <i>C1-07</i> [<i>Acceleration Times</i>]. Increase the value set in <i>C2-02</i> [<i>S-Curve Time @ End of Accel</i>]. Set <i>L3-11</i> = 1 [<i>Overvoltage Suppression Select = Enabled</i>].
		The braking load is too large.	Connect a dynamic braking option to the drive.
		There are surge voltages in the input power supply.	Connect a DC reactor to the drive. Note: If you turn the phase advancing capacitors ON and OFF and use thyristor converters in the same power supply system, there can be surge voltages that irregularly increase the input voltage.
		The drive output cable or motor is shorted to ground (the current short to ground is charging the main circuit capacitor of the drive through the power supply).	<ol style="list-style-type: none"> Examine the motor main circuit cable, terminals, and motor terminal box, and then remove ground faults. Re-energize the drive.

7.4 Fault

Code	Name	Causes	Possible Solutions
		<p>If the drive detects <i>ov</i> in these conditions, the speed search-related parameters are incorrect:</p> <ul style="list-style-type: none"> • During speed search • During momentary power loss recovery • When the drive starts again automatically • When you use an IE3 premium efficiency motor 	<ul style="list-style-type: none"> • Examine the settings for all speed search related parameters. • Set $b3-19 \neq 0$ [<i>Speed Search Restart Attempts $\neq 0$ times</i>]. • Adjust $b3-03$ [<i>Speed Search Deceleration Time</i>]. • Do Stationary Auto-Tuning for Line-to-Line Resistance and then set $b3-24 = 1$ [<i>Speed Search Method Selection = Speed Estimation</i>]. • Use these values to adjust the parameters. <ul style="list-style-type: none"> • $b3-03$ [<i>Speed Search Deceleration Time</i>] = default value $\times 2$ • $L2-03$ [<i>Minimum Baseblock Time</i>] = default value $\times 2$ • $L2-04$ [<i>Powerloss V/f Recovery Ramp Time</i>] = default value $\times 2$
		The power supply voltage is too high.	Decrease the power supply voltage to match the drive rated voltage.
		The braking resistor or braking resistor unit wiring is incorrect.	Correct wiring errors in the connection to the braking resistor or braking resistor unit.
		The encoder cable is disconnected or wired incorrectly.	Examine for wiring errors or disconnected wires in the encoder cable, and repair problems.
		Noise interference along the encoder cable.	Isolate the encoder cable from the drive output line or a different source of electrical interference.
		Electrical interference caused a drive malfunction.	<ul style="list-style-type: none"> • Examine the control circuit lines, main circuit lines, and ground wiring, and decrease the effects of electrical interference. • Make sure that a magnetic contactor is not the source of the electrical interference, then use a Surge Protective Device if necessary.
		The load inertia is set incorrectly.	<ul style="list-style-type: none"> • Examine the load inertia settings with KEB, overvoltage suppression, or stall prevention during deceleration. • Adjust $L3-25$ [<i>Load Inertia Ratio</i>] to match the qualities of the machine.
		You used the Short Circuit Braking function when $A1-02 = 5$ [<i>Control Method Selection = OLV/PMJ</i>].	Connect a braking resistor to the drive.
		There is motor hunting.	<ul style="list-style-type: none"> • Adjust $n1-02$ [<i>Hunting Prevention Gain Setting</i>]. • Adjust $n2-02$ [<i>Automatic Freq Regulator Time 1</i>] and $n2-03$ [<i>Automatic Freq Regulator Time 2</i>]. • Adjust $n8-45$ [<i>Speed Feedback Detection Gain</i>] and $n8-47$ [<i>Pull-in Current Comp Filter Time</i>].
		<p>Speed Search at Start does not complete correctly when:</p> <ul style="list-style-type: none"> • $A1-02 = 8$ [<i>Control Method Selection = EZOLV</i>] • $E9-01 = 0$ [<i>Motor Type Selection = Induction (IM)</i>] 	Set $b3-24 = 2$ [<i>Speed Search Method Selection = Current Detection 2</i>].
		<p>The drive detects <i>ov</i> [<i>Overvoltage</i>] when $A1-02 = 2$ [<i>OLV</i>] and when:</p> <ul style="list-style-type: none"> • The acceleration completes • The deceleration starts • The load changes suddenly 	<ul style="list-style-type: none"> • Increase the value set in $n2-03$ [<i>Automatic Freq Regulator Time 2</i>] in 50 ms increments. <p>Note:</p> <p>Make sure that this parameter setting is: $n2-02$ [<i>Automatic Freq Regulator Time 1</i>] $\leq n2-03$. When you adjust $n2-03$, you must also increase the $C4-06$ [<i>Motor 2 Torque Comp Delay Time</i>] value by the same ratio.</p> <ul style="list-style-type: none"> • Increase $C4-06$ in 10 ms increments. <p>Note:</p> <p>Make sure that this parameter setting is: $C4-02$ [<i>Torque Compensation Delay Time</i>] $\leq C4-06$. When you adjust $C4-06$, you must also increase the $n2-03$ [<i>Automatic Freq Regulator Time 2</i>] value by the same ratio.</p>
<p>Note:</p> <ul style="list-style-type: none"> • The drive detects this error if the DC bus voltage is more than the <i>ov</i> detection level while the drive is running. • Do a Fault Reset to clear the fault. • For 200 V class drives, the detection level of <i>ov</i> is approximately 410 V. For 400 V class drives, the detection level is approximately 820 V. • $L5-08$ [<i>Fault Reset Enable Select Grp2</i>] disables the Auto Restart function. 			
Code	Name	Causes	Possible Solutions
PE1	PLC Fault 1	The communication option detected a fault.	Refer to the manual for the communication option card.
<p>Note:</p> <p>Do a Fault Reset to clear the fault.</p>			
Code	Name	Causes	Possible Solutions
PE2	PLC Fault 2	The communication option detected a fault.	Refer to the manual for the communication option card.
<p>Note:</p> <p>Do a Fault Reset to clear the fault.</p>			

Code	Name	Causes	Possible Solutions
PF	Input Phase Loss	There is a phase loss in the drive input power.	Correct errors with the wiring for main circuit drive input power.
		There is loose wiring in the drive input power terminals.	Tighten the terminal screws to the correct tightening torque.
		The drive input power voltage is changing too much.	<ul style="list-style-type: none"> Examine the input power for problems. Make the drive input power stable. If the input power supply is good, examine the magnetic contactor on the main circuit side for problems.
		There is unsatisfactory balance between voltage phases.	<ul style="list-style-type: none"> Examine the input power for problems. Make the drive input power stable. Set $L8-05 = 0$ [<i>Input Phase Loss Protection Sel = Disabled</i>].
		The main circuit capacitors have become unserviceable.	<ul style="list-style-type: none"> Examine the capacitor maintenance time in monitor $U4-05$ [<i>Capacitor Maintenance</i>]. If $U4-05$ is more than 90%, replace the control board or the drive. For information about replacing the control board, contact Yaskawa or your nearest sales representative. If drive input power is correct and the fault stays, replace the control board or the drive. For information about replacing the control board, contact Yaskawa or your nearest sales representative.
Note: <ul style="list-style-type: none"> The drive detects this error if the DC bus voltage changes irregularly without regeneration. Do a Fault Reset to clear the fault. Use $L8-05$ to enable and disable PF detection. 			
Code	Name	Causes	Possible Solutions
PGo	Encoder (PG) Feedback Loss	The encoder cable is disconnected or wired incorrectly.	Examine for wiring errors or disconnected wires in the encoder cable, and repair problems.
		The encoder is not receiving power.	Examine the encoder power supply.
		The holding brake is stopping the motor.	Release the holding brake.
Note: <ul style="list-style-type: none"> The drive detects this error if it does not receive the speed detection pulse signal from the encoder in the detection time set in $F1-14$ [<i>Encoder Open-Circuit Detect Time</i>]. Do a Fault Reset to clear the fault. If the drive detects this error, it will operate the motor as specified by the Stopping Method set in $F1-02$ [<i>PG Open Circuit Detection Select</i>]. 			
Code	Name	Causes	Possible Solutions
PGoH	Encoder (PG) Hardware Fault	The encoder cable is disconnected.	Connect any disconnected wires in the encoder cable.
Note: <ul style="list-style-type: none"> Do a Fault Reset to clear the fault. Parameter $F1-20$ [<i>Encoder 1 PCB Disconnect Detect</i>] or $F1-36$ [<i>Encoder 2 PCB Disconnect Detect</i>] enables and disables $PGoH$ detection. If the drive detects this error, it will operate the motor as specified by the Stopping Method set in $F1-02$ [<i>PG Open Circuit Detection Select</i>]. 			
Code	Name	Causes	Possible Solutions
PSE	JOHB-SMP3 Protocol Set Error	<ul style="list-style-type: none"> The DIP switches on the JOHB-SMP3 are at their default setting. There is no protocol assigned to the JOHB-SMP3. 	Make sure that the power to the drive is OFF and the CHARGE LED light is OFF before you use the DIP switches on the JOHB-SMP3 to set the protocol. Refer to the JOHB-SMP3 manual for more information.
Code	Name	Causes	Possible Solutions
rF	Braking Resistor Fault	The resistance of the dynamic braking option that is connected to the drive is too low.	Use a dynamic braking option that fits the model and duty rating of the drive.
		A regenerative converter, regenerative unit, or braking unit is connected to the drive.	Set $L8-55 = 0$ [<i>Internal DB Transistor Protection = Disable</i>].
Note: Do a Fault Reset to clear the fault.			
Code	Name	Causes	Possible Solutions
rH	Braking Resistor Overheat	The deceleration time is too short and excessive regenerative energy is flowing back into the drive.	<ul style="list-style-type: none"> Check the load level, deceleration time, and speed. Decrease the load. Increase the values set in $C1-02$, $C1-04$, $C1-06$, or $C1-08$ [<i>Deceleration Times</i>]. Use a dynamic braking option that lets you use more power.
		The duty cycle is too high.	Examine the duty cycle. Note: When $L8-01 = 1$ [<i>3% ERF DB Resistor Protection = Enabled</i>], the maximum braking duty cycle is 3%.
		The braking load is too heavy.	<ul style="list-style-type: none"> Calculate the braking load and braking power again, and decrease the braking load. Use a braking resistor that improves braking power.

7.4 Fault

Code	Name	Causes	Possible Solutions
		The braking resistor is not sufficient.	Use the braking resistor specifications to select a sufficient braking resistor.
Note: <ul style="list-style-type: none"> The drive detects this error if the braking resistor overheat protective function is active. The magnitude of the braking load causes the braking resistor overheat alarm, NOT the surface temperature. If the duty cycle is higher than the braking resistor rating, the drive will show the alarm. Do a Fault Reset to clear the fault. Parameter <i>L8-01</i> enables and disables <i>rH</i> detection. 			
Code	Name	Causes	Possible Solutions
rr	Dynamic Braking Transistor Fault	The drive control circuit is damaged. There is a malfunction in the internal braking transistor of the drive.	<ul style="list-style-type: none"> Re-energize the drive. If the fault stays, replace the control board or the drive. For information about replacing the control board, contact Yaskawa or your nearest sales representative.
Note: Do a Fault Reset to clear the fault.			
Code	Name	Causes	Possible Solutions
SC	Short Circuit/IGBT Failure	Overheating caused damage to the motor or the motor insulation is not satisfactory.	Measure the motor insulation resistance, and replace the motor if there is electrical conduction or unserviceable insulation.
		The motor main circuit cable is contacting ground to make a short circuit.	<ul style="list-style-type: none"> Examine the motor main circuit cable for damage, and repair short circuits. Measure the resistance between the motor main circuit cable and the ground terminal. If there is electrical conduction, replace the cable.
		A short circuit or ground fault on the drive output side caused damage to the output transistor of the drive.	<ul style="list-style-type: none"> Make sure that there is not a short circuit in terminal B1 and terminals U/T1, V/T2, and W/T3. Make sure that there is not a short circuit in terminals - and terminals U/T1, V/T2, and W/T3. If there is a short circuit, contact Yaskawa or your nearest sales representative.
		When <i>A1-02</i> = 5, 6, 7 [<i>Control Method Selection</i> = <i>OLV/PM</i> , <i>AOLV/PM</i> , or <i>CLV/PM</i>], the output current is more than the value set in <i>L8-27</i> [<i>Overcurrent Detection Gain</i>].	Set <i>L8-27</i> correctly.
Note: <ul style="list-style-type: none"> The drive detects this error if there is a short circuit or ground fault on the drive output side, or an IGBT failure. Do a Fault Reset to clear the fault. 			
Code	Name	Causes	Possible Solutions
SCF	Safety Circuit Fault	The safety circuit is broken.	Replace the control board or the drive. For information about replacing the control board, contact Yaskawa or your nearest sales representative.
Note: Do a Fault Reset to clear the fault.			
Code	Name	Causes	Possible Solutions
SEr	Speed Search Retries Exceeded	The speed search-related parameters are set incorrectly.	<ul style="list-style-type: none"> Decrease <i>b3-10</i> [<i>Speed Estimation Detection Gain</i>]. Increase <i>b3-17</i> [<i>Speed Est Retry Current Level</i>]. Increase <i>b3-18</i> [<i>Speed Est Retry Detection Time</i>]. Do Auto-Tuning again.
		The motor is coasting in the opposite direction of the Run command.	Set <i>b3-14</i> = 1 [<i>Bi-directional Speed Search</i> = <i>Enabled</i>].
Note: <ul style="list-style-type: none"> The drive detects this error if the number of speed search restarts is more than <i>b3-19</i> [<i>Speed Search Restart Attempts</i>]. Do a Fault Reset to clear the fault. 			
Code	Name	Causes	Possible Solutions
STPo	Motor Step-Out Detected	The motor code is set incorrectly for PM Control Methods.	<ul style="list-style-type: none"> Set <i>E5-01</i> [<i>PM Motor Code Selection</i>] correctly as specified by the motor. For specialized motors, refer to the motor test report and set <i>E5-xx</i> correctly.
		The load is too large.	<ul style="list-style-type: none"> Increase the value set in <i>n8-55</i> [<i>Motor to Load Inertia Ratio</i>]. Increase the value set in <i>n8-51</i> [<i>Pull-in Current @ Acceleration</i>]. If the drive detects <i>STPo</i> during deceleration when increasing the value set in <i>n8-51</i>, set the value of <i>n8-79</i> [<i>Pull-in Current @ Deceleration</i>] lower than <i>n8-51</i>. Decrease the load. Replace the drive and motor with larger capacity models.
		The load inertia is too large.	Increase the value set in <i>n8-55</i> .
		The acceleration/deceleration times are too short.	<ul style="list-style-type: none"> Increase the values set in <i>C1-01</i> to <i>C1-08</i> [<i>Acceleration/Deceleration Times</i>]. Increase the value set in <i>C2-01</i> [<i>S-Curve Time @ Start of Accel</i>].

Code	Name	Causes	Possible Solutions
		Speed response is too slow.	Increase the value set in <i>n8-55</i> .
Note: Do a Fault Reset to clear the fault.			
Code	Name	Causes	Possible Solutions
SvE	Zero Servo Fault	The value set in the torque limit is too small.	Adjust torque limit-related parameters <i>L7-01</i> to <i>L7-04</i> .
		The load torque is too large.	Decrease the load torque.
		Noise interference along the encoder cable	Isolate the encoder cable from the drive output line or a different source of electrical interference.
Note: • The drive detects this error if motor rotation position moves during Zero Servo. • Do a Fault Reset to clear the fault.			
Code	Name	Causes	Possible Solutions
TiM	Keypad Time Not Set	There is a battery in the keypad, but the date and time are not set.	Use the keypad to set the date and time.
Note: • Do a Fault Reset to clear the fault. • Parameter <i>o4-24</i> [<i>bAT Detection Selection</i>] enables and disables <i>TiM</i> detection.			
Code	Name	Causes	Possible Solutions
UL3	Undertorque Detection 1	A fault occurred on the machine. Example: There is a broken pulley belt.	Examine the machine and remove the cause of the fault.
		The parameters are incorrect for the load.	Adjust <i>L6-02</i> [<i>Torque Detection Level 1</i>] and <i>L6-03</i> [<i>Torque Detection Time 1</i>] settings.
Note: • The drive detects this error if the drive output current is less than the level set in <i>L6-02</i> for longer than <i>L6-03</i> . • Do a Fault Reset to clear the fault. • If the drive detects this error, it will operate the motor as specified by the Stopping Method set in <i>L6-01</i> [<i>Torque Detection Selection 1</i>].			
Code	Name	Causes	Possible Solutions
UL4	Undertorque Detection 2	A fault occurred on the machine. Example: There is a broken pulley belt.	Examine the machine and remove the cause of the fault.
		The parameters are incorrect for the load.	Adjust <i>L6-05</i> [<i>Torque Detection Level 2</i>] and <i>L6-06</i> [<i>Torque Detection Time 2</i>] settings.
Note: • The drive detects this error if the drive output current is less than the level set in <i>L6-05</i> for longer than <i>L6-06</i> . • Do a Fault Reset to clear the fault. • If the drive detects this error, it will operate the motor as specified by the Stopping Method set in <i>L6-04</i> [<i>Torque Detection Selection 2</i>].			
Code	Name	Causes	Possible Solutions
UL5	Mechanical Weakening Detection 2	The drive detected undertorque as specified by the conditions for mechanical weakening detection set in <i>L6-08</i> [<i>Mechanical Fatigue Detect Select</i>].	Examine the machine for deterioration.
Note: • Do a Fault Reset to clear the fault. • If the drive detects this error, it will operate the motor as specified by the Stopping Method set in <i>L6-08</i> .			
Code	Name	Causes	Possible Solutions
Uv1	DC Bus Undervoltage	There is a phase loss in the drive input power.	Correct errors with the wiring for main circuit drive input power.
		There is loose wiring in the drive input power terminals.	Tighten the terminal screws to the correct tightening torque.
		The drive input power voltage is changing too much.	<ul style="list-style-type: none"> Examine the input power for problems. Make the drive input power stable. If the input power supply is good, examine the magnetic contactor on the main circuit side for problems.
		There was a loss of power.	Use a better power supply.
		The main circuit capacitors have become unserviceable.	Examine the capacitor maintenance time in monitor <i>U4-05</i> [<i>Capacitor Maintenance</i>]. If <i>U4-05</i> is more than 90%, replace the control board or the drive. For information about replacing the control board, contact Yaskawa or your nearest sales representative.
		The relay or contactor on the soft-charge bypass relay is damaged.	<i>U4-06</i> [<i>PreCharge Relay Mainte</i>] shows the performance life of the soft-charge bypass relay. If <i>U4-06</i> is more than 90%, replace the board or the drive. For information about replacing the board, contact Yaskawa or your nearest sales representative.
Note: • The drive detects this error if the DC bus voltage decreases below the level set in <i>L2-05</i> [<i>Undervoltage Detection Lvl (Uv1)</i>] while the drive is running. • The <i>Uv1</i> detection level is approximately 190 V for a 200 V class drives. The detection level is approximately 380 V for 400 V class drives. The detection level is approximately 350 V when <i>E1-01</i> [<i>Input AC Supply Voltage</i>] < 400. • Do a Fault Reset to clear the fault. • Fault trace is not available for this fault. • <i>L5-08</i> [<i>Fault Reset Enable Select Grp2</i>] disables the Auto Restart function.			

7.4 Fault

Code	Name	Causes	Possible Solutions
Uv2	Control Power Undervoltage	The value set in <i>L2-02 [Power Loss Ride Through Time]</i> increased and the momentary power loss recovery unit is not connected to the drive.	Connect the momentary power loss recovery unit to the drive.
		There was a problem with the drive hardware.	<ul style="list-style-type: none"> Re-energize the drive. If the fault stays, replace the control board or the drive. For information about replacing the control board, contact Yaskawa or your nearest sales representative.
Note: <ul style="list-style-type: none"> The drive detects this error if the control power supply voltage decreases. Do a Fault Reset to clear the fault. Fault trace is not available for this fault. 			
Code	Name	Causes	Possible Solutions
Uv3	Soft Charge Answerback Fault	There is damage to the relay or contactor on the soft-charge bypass relay.	<ul style="list-style-type: none"> Re-energize the drive. If the fault stays, replace the control board or the drive. Monitor <i>U4-06 [PreChargeRelayMainte]</i> shows the performance life of the soft-charge bypass relay. If <i>U4-06</i> is more than 90%, replace the board or the drive. For information about replacing the control board, contact Yaskawa or your nearest sales representative.
		Air inside the drive is too hot.	Decrease the ambient temperature of the drive.
Note: <ul style="list-style-type: none"> Do a Fault Reset to clear the fault. Fault trace is not available for these faults. 			

7.5 Minor Faults/Alarms

This section gives information about the causes and possible solutions when a minor fault or alarm occurs. Use the information in this table to remove the cause of the minor fault or alarm.

Code	Name	Causes	Possible Solutions
AEr	Station Address Setting Error	The node address for the communication option is not in the permitted setting range.	<ul style="list-style-type: none"> For CC-Link communication, set F6-10 [CC-Link Node Address] correctly. For MECHATROLINK communication, set F6-20 [MECHATROLINK Station Address] correctly. For CANopen communication, set F6-35 [CANopen Node ID Selection] correctly.
Note: If the drive detects this error, the terminal set to H2-01 to H2-03 = 10 [MFDO Function Select = Alarm] will activate.			
Code	Name	Causes	Possible Solutions
bAT	Keypad Battery Low Voltage	The keypad battery voltage is low.	Replace the keypad battery.
Note: • If detected, the terminal assigned to H2-01 to H2-03 = 10 [MFDO Function Select = Alarm] will switch ON. • Set o4-24 [bAT Detection Selection] to enable/disable bAT detection.			
Code	Name	Causes	Possible Solutions
bb	Baseblock	An external baseblock command was entered through one of the MFDI terminals Sx, and the drive output stopped as shown by an external baseblock command.	Examine the external sequence and timing of the baseblock command input.
Note: The drive will not output a minor fault signal for this alarm.			
Code	Name	Causes	Possible Solutions
bCE	Bluetooth Communication Error	The smartphone or tablet with DriveWizard Mobile installed is too far from the keypad.	Use the smartphone or tablet 10 m (32.8 ft.) or nearer to the keypad. Note: bCE can occur when the smartphone or tablet is 10 m (32.8 ft) or nearer to the keypad depending on the specifications of the smartphone or tablet.
		Radio waves from a different device are causing interference with communications between the smartphone or tablet and keypad.	Make sure that no device around the keypad uses the same radio bandwidth (2400 MHz to 2480 MHz), and prevent radio interference.
Note: • The drive detects this error when you use the Bluetooth LCD keypad to operate the drive from a smartphone or tablet. • If the drive detects this error, the terminal set to H2-01 to H2-03 = 10 [MFDO Function Selection = Alarm] will activate. • Parameter o2-27 [bCE Detection Selection] enables and disables bCE detection.			
Code	Name	Causes	Possible Solutions
boL	Braking Transistor Overload	The duty cycle of the braking transistor is high (the regeneration power or repetition frequency is high).	<ul style="list-style-type: none"> Install a braking unit (CDBR series). Install a regenerative converter. Increase the deceleration time.
		You enabled the protective function for the braking transistor when you have a regenerative converter.	Set L8-55 = 0 [Internal DB TransistorProtection = Disable].
		The braking transistor in the drive is broken.	Replace the drive.
Note: If the drive detects this error, the terminal assigned to H2-01 to H2-03 = 10 [MFDO Function Select = Alarm] will be ON.			
Code	Name	Causes	Possible Solutions
bUS	Option Communication Error	The communications cable wiring is incorrect.	Correct wiring errors.
		There is a short-circuit in the communications cable or the communications cable is not connected.	<ul style="list-style-type: none"> Repair short circuits and connect cables. Replace the defective communications cable.
		Electrical interference caused a communication data error.	<ul style="list-style-type: none"> Examine the control circuit lines, main circuit lines, and ground wiring, and decrease the effects of electrical interference. Make sure that a magnetic contactor is not the source of the electrical interference, then use a Surge Protective Device if necessary. Use only the recommended cables or other shielded line. Ground the shield on the controller side or the drive input power side. Separate the communication wiring from drive power lines, and install a noise filter to the input side of the power supply for communication. Decrease the effects of electrical interference from the controller.
		The option card is incorrectly installed to the drive.	Correctly install the option card to the drive.

7.5 Minor Faults/Alarms

Code	Name	Causes	Possible Solutions
		The option card is damaged.	If the alarm continues and the wiring is correct, replace the option card.
Note: <ul style="list-style-type: none"> The drive detects this error if the Run command or frequency reference is assigned to the option card. If the drive detects this error, the terminal set to H2-01 to H2-03 = 10 [MFDO Function Select = Alarm] will activate. If the drive detects this error, it will operate the motor as specified by the stopping method set in F6-01 [Communication Error Selection]. 			
Code	Name	Causes	Possible Solutions
bUSy	Busy	You set the drive to use MEMOBUS/Modbus communications to change parameters, but you used the keypad to change parameters.	Use MEMOBUS/Modbus communications to enter the enter command, then use the keypad to change the parameter.
		You tried to change a parameter while the drive was changing setting.	Wait until the process is complete.
Code	Name	Causes	Possible Solutions
CALL	Serial Comm Transmission Error	The communications cable wiring is incorrect.	Correct wiring errors.
		There is a short circuit in the communications cable or the communications cable is not connected.	<ul style="list-style-type: none"> Repair the short-circuited or disconnected portion of the cable. Replace the defective communications cable.
		A programming error occurred on the controller side.	Examine communications at start-up and correct programming errors.
		There is damage to the communications circuitry.	<ul style="list-style-type: none"> Do a self-diagnostics check. If the problem continues, replace the control board or the drive. Contact Yaskawa or your nearest sales representative to replace the control board.
		The termination resistor setting for MEMOBUS/Modbus communications is incorrect.	On the last drive in a MEMOBUS/Modbus network, set DIP switch S2 to the ON position to enable the termination resistor.
Note: <ul style="list-style-type: none"> The drive detects this error if it does not correctly receive control data from the controller when energizing the drive. If the drive detects this error, the terminal assigned to H2-01 to H2-03 = 10 [MFDO Function Select = Alarm] will activate. 			
Code	Name	Causes	Possible Solutions
CE	Modbus Communication Error	The communications cable wiring is incorrect.	Correct wiring errors.
		There is a short circuit in the communications cable or the communications cable is not connected.	<ul style="list-style-type: none"> Repair short circuits and connect cables. Replace the defective communications cable.
		Electrical interference caused a communication data error.	<ul style="list-style-type: none"> Examine the control circuit lines, main circuit lines, and ground wiring, and decrease the effects of electrical interference. Make sure that a magnetic contactor is not the source of the electrical interference, then use a Surge Protective Device if necessary. Use only the recommended cables or other shielded line. Ground the shield on the controller side or the drive input power side. Separate the communication wiring from drive power lines, and install a noise filter to the input side of the power supply for communication. Decrease the effects of electrical interference from the controller.
		The communication protocol is not compatible.	<ul style="list-style-type: none"> Examine the values set in H5-xx. Examine the settings on the controller side and correct the difference in communication conditions.
		The value set in H5-09 [CE Detection Time] is too small for the communications cycle.	<ul style="list-style-type: none"> Change the controller software settings. Increase the value set in H5-09.
		The controller software or hardware is causing a communication problem.	Examine the controller and remove the cause of the problem.
Note: <ul style="list-style-type: none"> The drive detects this error if it does not correctly receive control data for the CE detection time set to H5-09. If the drive detects this error, the terminal assigned to H2-01 to H2-03 = 10 [MFDO Function Select = Alarm] will be ON. If the drive detects this error, it will operate the motor as specified by the stopping method set in H5-04 [Communication Error Stop Method]. 			
Code	Name	Causes	Possible Solutions
CP1	Comparator 1 Limit Error	The monitor value set in H2-20 [Comparator 1 Monitor Selection] was in the range of H2-21 [Comparator 1 Lower Limit] and H2-22 [Comparator 1 Upper Limit].	Examine the monitor value and remove the cause of the error.
Note: <ul style="list-style-type: none"> The drive detects this error when the terminal is assigned to H2-01 to H2-03 = 66 [MFDO Function Select = Comparator1]. If the drive detects this error, the terminal assigned to H2-01 to H2-03 = 10 [MFDO Function Select = Alarm] will be ON. H2-33 [Comparator1 Protection Selection] enables and disables CP1 detection. 			

Code	Name	Causes	Possible Solutions
CP2	Comparator 2 Limit Error	The monitor value set in H2-26 [Comparator 2 Monitor Selection] was outside the range of H2-27 [Comparator 2 Lower Limit] and H2-28 [Comparator 2 Upper Limit].	Examine the monitor value and remove the cause of the error.
Note: <ul style="list-style-type: none"> The drive detects this error when the terminal is assigned to H2-01 to H2-03 = 67 [MFDO Function Select = Comparator2]. If the drive detects this error, the terminal assigned to H2-01 to H2-03 = 10 [MFDO Function Select = Alarm] will be ON. H2-35 [Comparator2 Protection Selection] enables and disables CP2 detection. 			
Code	Name	Causes	Possible Solutions
CrST	Cannot Reset	The drive received a fault reset command when a Run command was active.	Turn off the Run command then de-energize and re-energize the drive.
Code	Name	Causes	Possible Solutions
CyC	MECHATROLINK CommCycleSettingErr	The communications cycle setting of the controller is not in the permitted range of the MECHATROLINK interface option.	Set the communications cycle of the controller in the permitted range of the MECHATROLINK interface option.
Note: If the drive detects this error, the terminal set to H2-01 to H2-03 = 10 [MFDO Function Select = Alarm] will activate.			
Code	Name	Causes	Possible Solutions
CyPo	Cycle Power to Accept Changes	Although F6-15 = 1 [Comm. Option Parameters Reload = Reload Now], the drive does not update the communication option parameters.	Re-energize the drive to update the communication option parameters.
Code	Name	Causes	Possible Solutions
dEv	Speed Deviation	The load is too heavy	Decrease the load.
		Acceleration and deceleration times are set too short.	Increase the values set in C1-01 to C1-08 [Acceleration/Deceleration Time].
		The dEv detection level settings are incorrect.	Adjust F1-10 [Speed Deviation Detection Level] and F1-11 [Speed Deviation Detect DelayTime].
		The load is locked up.	Examine the machine.
		The holding brake is stopping the motor.	Release the holding brake.
Note: <ul style="list-style-type: none"> The drive detects this error if the difference between the detected speed and the speed reference is more than the setting of F1-10 for longer than F1-11. If the drive detects this error, the terminal assigned to H2-01 to H2-03 = 10 [MFDO Function Select = Alarm] will be ON. If the drive detects this error, the drive will operate the motor as specified by the stopping method set in F1-04 [Speed Deviation Detection Select]. 			
Code	Name	Causes	Possible Solutions
dnE	Drive Disabled	A terminal set for H1-xx = 6A [Drive Enable] turned OFF.	Examine the operation sequence.
Note: If the drive detects this error, the terminal assigned to H2-01 to H2-03 = 10 [MFDO Function Select = Alarm] will be ON.			
Code	Name	Causes	Possible Solutions
dWA2	DriveWorksEZ Alarm 2	There was an error in the DriveWorksEZ program.	Examine the DriveWorksEZ program and remove the cause of the error. This is not a drive fault.
Note: If the drive detects this error, the terminal assigned to H2-01 to H2-03 = 10 [MFDO Function Select = Alarm] will be ON.			
Code	Name	Causes	Possible Solutions
dWA3	DriveWorksEZ Alarm 3	There was an error in the DriveWorksEZ program.	Examine the DriveWorksEZ program and remove the cause of the error. This is not a drive fault.
Note: If the drive detects this error, the terminal assigned to H2-01 to H2-03 = 10 [MFDO Function Select = Alarm] will be ON.			
Code	Name	Causes	Possible Solutions
dWAL	DriveWorksEZ Alarm	There was an error in the DriveWorksEZ program.	Examine the DriveWorksEZ program and remove the cause of the error. This is not a drive fault.
Note: If the drive detects this error, the terminal assigned to H2-01 to H2-03 = 10 [MFDO Function Select = Alarm] will be ON.			
Code	Name	Causes	Possible Solutions
E5	MECHATROLINK Watchdog Timer Err	The drive detected a watchdog circuit exception while it received data from the controller.	Examine the MECHATROLINK cable connection. If this error occurs frequently, examine the wiring and decrease the effects of electrical interference as specified by these manuals: <ul style="list-style-type: none"> MECHATROLINK-II Installation Guide (MECHATROLINK Members Association, manual number MMATDEP011) MECHATROLINK-III Installation Manual (MECHATROLINK Members Association, publication number MMATDEP018)
Note: <ul style="list-style-type: none"> If the drive detects this error, the terminal assigned to H2-01 to H2-03 = 10 [MFDO Function Select = Alarm] will be ON. If the drive detects this error, it will operate the motor as specified by the stop method set in F6-25 [MECHATROLINK Watchdog Error Sel]. 			

7.5 Minor Faults/Alarms

Code	Name	Causes	Possible Solutions
EF	FWD/REV Run Command Input Error	A forward command and a reverse command were input at the same time for longer than 0.5 s.	Examine the forward and reverse command sequence and correct the problem.
Note: <ul style="list-style-type: none"> If the drive detects <i>EF</i>, the motor will ramp to stop. If the drive detects this error, the terminal assigned to <i>H2-01 to H2-03 = 10 [MFDO Function Select = Alarm]</i> will be ON. 			
Code	Name	Causes	Possible Solutions
EF0	Option Card External Fault	The communication option card received an external fault from the controller.	<ol style="list-style-type: none"> Find the device that caused the external fault and remove the cause. Clear the external fault input from the controller.
		Programming error occurred on the controller side.	Examine the operation of the controller program.
Note: <ul style="list-style-type: none"> The drive detects this error if the alarm function on the external device side is operating. If the drive detects this error, the terminal assigned to <i>H2-01 to H2-03 = 10 [MFDO Function Select = Alarm]</i> will be ON. Set the stopping method for this fault in <i>F6-03 [Comm External Fault (EF0) Select]</i>. 			
Code	Name	Causes	Possible Solutions
EF1	External Fault (Terminal S1)	MFDI terminal S1 caused an external fault through an external device.	<ol style="list-style-type: none"> Find the device that caused the external fault and remove the cause. Clear the external fault input in the MFDI.
		The wiring is incorrect.	Correctly connect the signal line to MFDI terminal S1.
		<i>External Fault [H1-01 = 2C to 2F]</i> is set to MFDI terminal S1, but the terminal is not in use.	Correctly set the MFDI.
Note: <p>If the drive detects this error, the terminal assigned to <i>H2-01 to H2-03 = 10 [MFDO Function Select = Alarm]</i> will be ON.</p>			
Code	Name	Causes	Possible Solutions
EF2	External Fault (Terminal S2)	MFDI terminal S2 caused an external fault through an external device.	<ol style="list-style-type: none"> Find the device that caused the external fault and remove the cause. Clear the external fault input in the MFDI.
		The wiring is incorrect.	Correctly connect the signal line to MFDI terminal S2.
		<i>External Fault [H1-02 = 2C to 2F]</i> is set to MFDI terminal S2, but the terminal is not in use.	Correctly set the MFDI.
Note: <p>If the drive detects this error, the terminal assigned to <i>H2-01 to H2-03 = 10 [MFDO Function Select = Alarm]</i> will be ON.</p>			
Code	Name	Causes	Possible Solutions
EF3	External Fault (Terminal S3)	MFDI terminal S3 caused an external fault through an external device.	<ol style="list-style-type: none"> Find the device that caused the external fault and remove the cause. Clear the external fault input in the MFDI.
		The wiring is incorrect.	Correctly connect the signal line to MFDI terminal S3.
		<i>External Fault [H1-03 = 2C to 2F]</i> is set to MFDI terminal S3, but the terminal is not in use.	Correctly set the MFDI.
Note: <p>If the drive detects this error, the terminal assigned to <i>H2-01 to H2-03 = 10 [MFDO Function Select = Alarm]</i> will be ON.</p>			
Code	Name	Causes	Possible Solutions
EF4	External Fault (Terminal S4)	MFDI terminal S4 caused an external fault through an external device.	<ol style="list-style-type: none"> Find the device that caused the external fault and remove the cause. Clear the external fault input in the MFDI.
		The wiring is incorrect.	Correctly connect the signal line to MFDI terminal S4.
		<i>External Fault [H1-04 = 2C to 2F]</i> is set to MFDI terminal S4, but the terminal is not in use.	Correctly set the MFDI.
Note: <p>If the drive detects this error, the terminal assigned to <i>H2-01 to H2-03 = 10 [MFDO Function Select = Alarm]</i> will be ON.</p>			
Code	Name	Causes	Possible Solutions
EF5	External Fault (Terminal S5)	MFDI terminal S5 caused an external fault through an external device.	<ol style="list-style-type: none"> Find the device that caused the external fault and remove the cause. Clear the external fault input in the MFDI.
		The wiring is incorrect.	Correctly connect the signal line to MFDI terminal S5.
		<i>External Fault [H1-05 = 2C to 2F]</i> is set to MFDI terminal S5, but the terminal is not in use.	Correctly set the MFDI.
Note: <p>If the drive detects this error, the terminal assigned to <i>H2-01 to H2-03 = 10 [MFDO Function Select = Alarm]</i> will be ON.</p>			

Code	Name	Causes	Possible Solutions
EF6	External Fault (Terminal S6)	MFDI terminal S6 caused an external fault through an external device.	1. Find the device that caused the external fault and remove the cause. 2. Clear the external fault input in the MFDI.
		The wiring is incorrect.	Correctly connect the signal line to MFDI terminal S6.
		<i>External Fault [H1-06 = 2C to 2F]</i> is set to MFDI terminal S6, but the terminal is not in use.	Correctly set the MFDI.
Note: If the drive detects this error, the terminal assigned to <i>H2-01 to H2-03 = 10 [MFDO Function Select = Alarm]</i> will be ON.			
Code	Name	Causes	Possible Solutions
EF7	External Fault (Terminal S7)	MFDI terminal S7 caused an external fault through an external device.	1. Find the device that caused the external fault and remove the cause. 2. Clear the external fault input in the MFDI.
		The wiring is incorrect.	Correctly connect the signal line to MFDI terminal S7.
		<i>External Fault [H1-07 = 2C to 2F]</i> is set to MFDI terminal S7, but the terminal is not in use.	Correctly set the MFDI.
Note: If the drive detects this error, the terminal assigned to <i>H2-01 to H2-03 = 10 [MFDO Function Select = Alarm]</i> will be ON.			
Code	Name	Causes	Possible Solutions
EF8	External Fault (Terminal S8)	MFDI terminal S8 caused an external fault through an external device.	1. Find the device that caused the external fault and remove the cause. 2. Clear the external fault input in the MFDI.
		The wiring is incorrect.	Correctly connect the signal line to MFDI terminal S8.
		<i>External Fault [H1-08 = 2C to 2F]</i> is set to MFDI terminal S8, but the terminal is not in use.	Correctly set the MFDI.
Note: If the drive detects this error, the terminal assigned to <i>H2-01 to H2-03 = 10 [MFDO Function Select = Alarm]</i> will be ON.			
Code	Name	Causes	Possible Solutions
EP24v	External Power 24V Supply	The voltage of the main circuit power supply decreased, and the 24 V power supply is supplying power to the drive.	<ul style="list-style-type: none"> Examine the main circuit power supply. Turn ON the main circuit power supply to run the drive.
Note: <ul style="list-style-type: none"> Set <i>a2-26 [Ext. Power 24V Supply Display]</i> to enable or disable <i>EP24v</i> detection. The drive will not output an alarm signal for this alarm. 			
Code	Name	Causes	Possible Solutions
FAn	Internal Fan Fault	The circulation fan stopped operating correctly.	<ul style="list-style-type: none"> Examine circulation fan operation. Re-energize the drive. Examine <i>U4-03 [Cooling Fan Ope Time]</i> and <i>U4-04 [Cool Fan Maintenance]</i>. If there is damage to the circulation fan or if the performance life of the fan is expired, replace the fan.
Note: If the drive detects this error, the terminal set to <i>H2-01 to H2-03 = 10 [MFDO Function Selection = Alarm]</i> will activate.			
Code	Name	Causes	Possible Solutions
FbH	Excessive PID Feedback	The <i>FbH</i> detection level is set incorrectly.	Adjust <i>b5-36 [PID High Feedback Detection Lvl]</i> and <i>b5-37 [PID High Feedback Detection Time]</i> .
		There is a problem with the PID feedback wiring.	Correct errors with the PID control wiring.
		The feedback sensor is not operating correctly.	Examine the sensors on the control device side.
		A fault occurred in the feedback input circuit of the drive.	Replace the control board or the drive. For information about replacing the control board, contact Yaskawa or your nearest sales representative.
Note: <ul style="list-style-type: none"> The drive detects this fault if the PID feedback input is more than the level set in <i>b5-36</i> for longer than <i>b5-37</i>. If detected, the terminal assigned to <i>H2-01 to H2-03 = 10 [MFDO Function Select = Alarm]</i> will be ON. If the drive detects this fault, it will operate the motor as specified by the stop method set in <i>b5-12 [Feedback Loss Detection Select]</i>. 			
Code	Name	Causes	Possible Solutions
FbL	PID Feedback Loss	The <i>FbL</i> detection level is set incorrectly.	Adjust <i>b5-13 [PID Feedback Loss Detection Lvl]</i> and <i>b5-14 [PID Feedback Loss Detection Time]</i> .
		There is a problem with the PID feedback wiring.	Correct errors with the PID control wiring.
		The feedback sensor is not operating correctly.	Examine the sensors on the control device side.

7.5 Minor Faults/Alarms

Code	Name	Causes	Possible Solutions
		A fault occurred in the feedback input circuit of the drive.	Replace the control board or the drive. For information about replacing the control board, contact Yaskawa or your nearest sales representative.
Note: <ul style="list-style-type: none"> The drive detects this error if the PID feedback input is lower than the level set in <i>b5-13</i> for longer than <i>b5-14</i>. If the drive detects this error, the terminal assigned to <i>H2-01</i> to <i>H2-03</i> = <i>10</i> [<i>MFDO Function Select = Alarm</i>] will be ON. If the drive detects this error, it will operate the motor as specified by the stop method set in <i>b5-12</i> [<i>Feedback Loss Detection Select</i>]. 			
Code	Name	Causes	Possible Solutions
HCA	High Current Alarm	The load is too heavy.	<ul style="list-style-type: none"> Decrease the load for applications with repetitive starts and stops. Replace the drive with a larger capacity model.
		The acceleration time is too short.	<ul style="list-style-type: none"> Calculate the torque necessary during acceleration related to the load inertia and the specified acceleration time. Increase the values set in <i>C1-01</i>, <i>C1-03</i>, <i>C1-05</i>, or <i>C1-07</i> [<i>Acceleration Times</i>] until you get the necessary torque. Increase the values set in <i>C2-01</i> to <i>C2-04</i> [<i>S-Curve Characteristics</i>] until you get the necessary torque. Replace the drive with a larger capacity model.
		The drive is trying to operate a specialized motor or a motor that is larger than the maximum applicable motor output of the drive.	<ul style="list-style-type: none"> Examine the motor nameplate, the motor, and the drive to make sure that the drive rated current is larger than the motor rated current. Replace the drive with a larger capacity model.
		The current level temporarily increased because of speed search after a momentary power loss or while trying to Auto Restart.	If speed search or Auto Restart cause an increase in current, the drive can temporarily show this alarm. The time that the drive shows the alarm is short. No more steps are necessary to clear the alarm.
Note: <ul style="list-style-type: none"> The drive detects this error if the drive output current is more than the overcurrent alarm level (150% of the rated current). If the drive detects this error, the terminal assigned to <i>H2-01</i> to <i>H2-03</i> = <i>10</i> [<i>MFDO Function Select = Alarm</i>] will be ON. 			
Code	Name	Causes	Possible Solutions
L24v	Loss of External Power 24 Supply	The voltage of the backup 24 V power supply has decreased. The main circuit power supply is operating correctly.	<ul style="list-style-type: none"> Examine the external 24 V power supply for disconnected wires and wiring errors and repair the problems. Examine the external 24 V power supply for problems.
Note: <ul style="list-style-type: none"> Set <i>o2-23</i> [<i>External 24V Powerloss Detection</i>] to enable or disable <i>L24v</i> detection. The drive will not output an alarm signal for this alarm. 			
Code	Name	Causes	Possible Solutions
LoG	Log Com Error	There is not a micro SD card in the keypad.	Put a micro SD card in the keypad.
		<ul style="list-style-type: none"> The drive is connected to USB. The number of log communication files is more than 1000. The micro SD card does not have available memory space. The line number data in a log communication file was changed. There was a communication error between the keypad and drive during a log communication. 	Set <i>o5-01</i> = <i>0</i> [<i>Log Start/Stop Selection = OFF</i>].
		You used a keypad that does not support short-term data logging and started short-term data logging.	<ul style="list-style-type: none"> Use a keypad that supports short-term data logging. Set <i>o5-00</i> = <i>0</i> [<i>Log Type = Long Term Log</i>]. Set <i>o5-01</i> = <i>0</i> [<i>Log Start/Stop Selection = OFF</i>].
Note: <ul style="list-style-type: none"> If the drive detects this error, the terminal assigned to <i>H2-01</i> to <i>H2-03</i> = <i>6A</i> [<i>MFDO Function Select = Data Logger Error</i>] will be ON. You can use short-term data logging with an LCD keypad or a Bluetooth LCD Keypad version REV:H or later. Refer to "REV" on the keypad nameplate for the keypad version. 			
Code	Name	Causes	Possible Solutions
LT-1	Cooling Fan Maintenance Time	The cooling fan is at 90% of its expected performance life.	<ol style="list-style-type: none"> Replace the cooling fan. Set <i>o4-03</i> = <i>0</i> [<i>Fan Operation Time Setting = 0 h</i>] to reset the cooling fan operation time.
Note: <p>When the estimated performance life is expired, the terminal set to <i>H2-01</i> to <i>H2-03</i> = <i>2F</i> [<i>MFDO Function Selection = Maintenance Notification</i>] will activate.</p>			
Code	Name	Causes	Possible Solutions
LT-2	Capacitor Maintenance Time	The capacitors for the main circuit and control circuit are at 90% of expected performance life.	Replace the control board or the drive. For information about replacing the control board, contact Yaskawa or your nearest sales representative.
Note: <p>When the estimated performance life is expired, the terminal assigned to <i>H2-01</i> to <i>H2-03</i> = <i>2F</i> [<i>MFDO Function Select = Maintenance Notification</i>] will be ON.</p>			

Code	Name	Causes	Possible Solutions
LT-3	SoftChargeBypassRelay MainteTime	The soft charge bypass relay is at 90% of its expected performance life.	Replace the control board or the drive. For information about replacing the control board, contact Yaskawa or your nearest sales representative.
Note: When the estimated performance life is expired, the terminal assigned to H2-01 to H2-03 = 2F [MFDO Function Select = Maintenance Notification] will be ON.			
Code	Name	Causes	Possible Solutions
LT-4	IGBT Maintenance Time (50%)	The IGBT is at 50% of its expected performance life.	Check the load, carrier frequency, and output frequency.
Note: When the estimated performance life is expired, the terminal assigned to H2-01 to H2-03 = 2F [MFDO Function Select = Maintenance Notification] will be ON.			
Code	Name	Causes	Possible Solutions
oH	Heatsink Overheat	The ambient temperature is high and the heatsink temperature is more than the L8-02 [Overheat Alarm Level].	<ul style="list-style-type: none"> Measure the ambient temperature. Increase the airflow around the drive. Install a cooling device (cooling fan or air conditioner) to lower the ambient temperature. Remove objects near the drive that are producing too much heat.
		There is not sufficient airflow around the drive.	<ul style="list-style-type: none"> Give the drive the correct installation space as shown in the manual. Make sure that there is sufficient circulation around the control panel. Examine the drive for dust or other unwanted materials that could clog the cooling fan. Remove unwanted materials that prevent air circulation.
		The internal cooling fan or fans have stopped.	<ol style="list-style-type: none"> Use the procedures in this manual to replace the cooling fan. Set o4-03 = 0 [Fan Operation Time Setting = 0 h] to reset the cooling fan operation time.
Note: <ul style="list-style-type: none"> The drive detects this error if the heatsink temperature of the drive is more than L8-02. If the drive detects this error, the terminal assigned to H2-01 to H2-03 = 10 [MFDO Function Select = Alarm] will be ON. Set the stopping method for this fault in L8-03 [Overheat Pre-Alarm Selection]. 			
Code	Name	Causes	Possible Solutions
oH2	External Overheat (H1-XX=B)	An external device sent an oH2.	<ol style="list-style-type: none"> Find the external device that output the overheat alarm. Remove the cause of the problem. Clear the Overheat Alarm (oH2) [H1-xx = B] that was set to MFDI terminals S1 to S6.
Note: If the drive detects this error, the terminal set to H2-01 to H2-02 = 10 [MFDO Function Selection = Alarm] will activate.			
Code	Name	Causes	Possible Solutions
oH3	Motor Overheat (PTC Input)	The thermistor wiring that detects motor temperature is defective.	Correct wiring errors.
		A fault occurred on the machine. Example: The machine is locked.	Examine the machine and remove the cause of the fault
		The motor has overheated.	<ul style="list-style-type: none"> Check the load level, acceleration/deceleration time, and motor start/stop frequency (cycle time). Decrease the load. Increase the values set in C1-01 to C1-08 [Acceleration/Deceleration Times]. Set E2-01 [Motor Rated Current (FLA)] correctly to the value specified by the motor nameplate. Make sure that the motor cooling system is operating correctly, and repair or replace it if it is damaged. Adjust E1-04 to E1-10 [V/f Pattern Parameters]. For motor 2, adjust E3-04 to E3-10. Decrease the values set in E1-08 [Mid Point A Voltage] and E1-10 [Minimum Output Voltage]. <p>Note: If the values set in E1-08 and E1-10 are too low, the overload tolerance will decrease at low speeds.</p>
Note: <ul style="list-style-type: none"> When H3-02, H3-10, or H3-06 = E [MFAI Function Selection = Motor Temperature (PTC Input)], the drive detects this fault if the motor overheat signal entered to an analog input terminal A1, A2, or A3 is more than the alarm detection level. If the drive detects this error, the terminal set to H2-01 to H2-03 = 10 [MFDO Function Select = Alarm] will activate. If the drive detects this error, it will operate the motor as specified by the stopping method set in L1-03 [Motor Thermistor oH Alarm Select]. 			

7.5 Minor Faults/Alarms

Code	Name	Causes	Possible Solutions
oL3	Overtorque 1	A fault occurred on the machine. Example: The machine is locked.	Examine the machine and remove the cause of the fault.
		The parameters are incorrect for the load.	Adjust L6-02 [Torque Detection Level 1] and L6-03 [Torque Detection Time 1] settings.
Note: <ul style="list-style-type: none"> The drive detects this fault if the drive output current is more than the level set in L6-02 for longer than L6-03. If the drive detects this error, the terminal assigned to H2-01 to H2-03 = 10 [MFDO Function Select = Alarm] will be ON. Set the conditions that trigger the minor fault using L6-01 [Torque Detection Selection 1]. 			
Code	Name	Causes	Possible Solutions
oL4	Overtorque 2	A fault occurred on the machine. Example: The machine is locked.	Examine the machine and remove the cause of the fault.
		The parameters are incorrect for the load.	Adjust L6-05 [Torque Detection Level 2] and L6-06 [Torque Detection Time 2] settings.
Note: <ul style="list-style-type: none"> The drive detects this error if the drive output current is more than the level set in L6-05 for longer than L6-06. If the drive detects this error, the terminal assigned to H2-01 to H2-03 = 10 [MFDO Function Select = Alarm] will be ON. Set the conditions that trigger the minor fault using L6-04 [Torque Detection Selection 2]. 			
Code	Name	Causes	Possible Solutions
oL5	Mechanical Weakening Detection 1	The drive detected overtorque as specified by the conditions for mechanical weakening detection set in L6-08 [Mechanical Fatigue Detect Select].	Do a deterioration diagnostic test on the machine side.
Note: <ul style="list-style-type: none"> If the drive detects this error, the terminal assigned to H2-01 to H2-03 = 10 [MFDO Function Select = Alarm] will be ON. If the drive detects this minor fault, it will operate the motor as specified by the Stopping Method set in L6-08. 			
Code	Name	Causes	Possible Solutions
oS	Overspeed	There is overshoot.	<ul style="list-style-type: none"> Decrease C5-01 [ASR Proportional Gain 1] and increase C5-02 [ASR Integral Time 1]. Use H6-02 to H6-05 [Pulse Train Input Setting Parameters] to adjust the pulse train gain.
		There is an incorrect number of PG pulses set in the drive.	Set H6-02 [Terminal RP Frequency Scaling] to the pulse train frequency during 100% reference (maximum motor rotation speed).
		The oS detection level is set incorrectly.	Adjust F1-08 [Overspeed Detection Level] and F1-09 [Overspeed Detection Delay Time].
Note: <ul style="list-style-type: none"> The drive detects this error if the motor speed is more than the value set in F1-08 for longer than F1-09. If the drive detects this error, the terminal set to H2-01 to H2-03 = 10 [MFDO Function Select = Alarm] will activate. If the drive detects this error, it will operate the motor as specified by the stopping method set in F1-03 [Overspeed Detection Selection]. 			
Code	Name	Causes	Possible Solutions
ov	Overvoltage	There are surge voltages in the input power supply.	Connect a DC reactor to the drive. Note: If you turn the phase advancing capacitors ON and OFF and use thyristor converters in the same power supply system, there can be surge voltages that irregularly increase the input voltage.
		The drive output cable or motor is shorted to ground (the current short to ground is charging the main circuit capacitor of the drive through the power supply).	<ol style="list-style-type: none"> Examine the motor main circuit cable, terminals, and motor terminal box, and then remove ground faults. Re-energize the drive.
		The power supply voltage is too high.	Decrease the power supply voltage to match the drive rated voltage.
		Electrical interference caused a drive malfunction.	<ul style="list-style-type: none"> Examine the control circuit lines, main circuit lines, and ground wiring, and decrease the effects of electrical interference. Make sure that a magnetic contactor is not the source of the electrical interference, then use a Surge Protective Device if necessary. Set L5-01 $\neq 0$ [Number of Auto-Restart Attempts $\neq 0$ times].
		The drive detects ov [Overvoltage] when: <ul style="list-style-type: none"> The acceleration completes The deceleration starts The load changes suddenly 	<ul style="list-style-type: none"> Increase the value set in n2-03 [Automatic Freq Regulator Time 2] in 50 ms increments. Note: Make sure that you set $n2-02 \leq n2-03$. When you adjust n2-03, you must also increase the C4-06 [Motor 2 Torque Comp Delay Time] value by same ratio. Increase C4-06 in 10 ms increments. Note: Make sure that you set $C4-02 \leq C4-06$. When you adjust C4-06, you must also increase the n2-03 value by same ratio.
Note: <ul style="list-style-type: none"> The drive detects this error if the DC bus voltage is more than the ov detection level when there is no Run command (while the drive is stopped). The ov detection level is approximately 410 V with 200 V class drives. The detection level is approximately 820 V for 400 V class drives. If the drive detects this error, the terminal set to H2-01 to H2-03 = 10 [MFDO Function Select = Alarm] will activate. 			

Code	Name	Causes	Possible Solutions
ovEr	Too Many Parameters Changed	You tried to change more than 150 parameters.	Make sure that parameters that do not have an effect on drive operation are at their default settings. Note: • You can change 150 parameters maximum. • If you change parameters that have dependencies, the drive can detect <i>ovEr</i> when the number of changed parameters is fewer than 150.
Code	Name	Causes	Possible Solutions
PASS	Modbus Communication Test	The MEMOBUS/Modbus communications test is complete.	The <i>PASS</i> display will turn off after communications test mode is cleared.
Code	Name	Causes	Possible Solutions
PF	Input Phase Loss	There is a phase loss in the drive input power.	Correct all wiring errors with the main circuit power supply.
		Loose wiring in the input power terminals.	Tighten the screws to the correct tightening torque.
		The drive input power voltage is changing too much.	<ul style="list-style-type: none"> Examine the supply voltage for problems. Make the drive input power stable.
		Unsatisfactory balance between voltage phases.	<ul style="list-style-type: none"> Examine the supply voltage for problems. Make the drive input power stable. If the supply voltage is good, examine the magnetic contactor on the main circuit side for problems.
		The main circuit capacitors have become unserviceable.	<ul style="list-style-type: none"> Examine the capacitor maintenance time in monitor <i>U4-05 [Capacitor Maintenance]</i>. If <i>U4-05</i> is more than 90%, replace the capacitor. Contact Yaskawa or your nearest sales representative for more information.
Note: <ul style="list-style-type: none"> The drive detects this error if the DC bus voltage changes irregularly without regeneration. If the drive detects this error, the terminal assigned to <i>H2-01 to H2-03 = 10 [MFDO Function Select = Alarm]</i> will be ON. Use <i>L8-05 [Input Phase Loss Protection Sel]</i> to enable and disable <i>PF</i> detection. 			
Code	Name	Causes	Possible Solutions
PGo	Encoder (PG) Feedback Loss	The encoder cable is disconnected or wired incorrectly.	Examine for wiring errors or disconnected wires in the encoder cable, and repair problems.
		The encoder is not receiving power.	Examine the encoder power supply.
		The holding brake is stopping the motor.	Release the holding brake.
Note: <ul style="list-style-type: none"> The drive detects this error if it does not receive the speed detection pulse signal from the encoder in the detection time set in <i>F1-14 [Encoder Open-Circuit Detect Time]</i>. If the drive detects this error, the terminal assigned to <i>H2-01 to H2-03 = 10 [MFDO Function Select = Alarm]</i> will be ON. If the drive detects this error, it will operate the motor as specified by the Stopping Method set in <i>F1-02 [PG Open Circuit Detection Select]</i>. 			
Code	Name	Causes	Possible Solutions
PGoH	Encoder (PG) Hardware Fault	The encoder cable is disconnected.	Correct any disconnected wires in the encoder cable.
Note: <ul style="list-style-type: none"> If the drive detects this error, the terminal set to <i>H2-01 to H2-03 = 10 [MFDO Function Select = Alarm]</i> will activate. Parameters <i>F1-20 [Encoder 1 PCB Disconnect Detect]</i> or <i>F1-36 [Encoder 2 PCB Disconnect Detect]</i> enable and disable <i>PGoH</i> detection. If the drive detects this error, it will operate the motor as specified by the stopping method set in <i>F1-02 [PG Open Circuit Detection Select]</i>. 			
Code	Name	Causes	Possible Solutions
rUn	Motor Switch during Run	The drive received a <i>Motor 2 Selection [H1-xx = 16]</i> during run.	Make sure that the drive receives the Motor 2 Selection while the drive is stopped.
Note: If the drive detects this error, the terminal assigned to <i>H2-01 to H2-03 = 10 [MFDO Function Select = Alarm]</i> will be ON.			
Code	Name	Causes	Possible Solutions
SE	Modbus Test Mode Error	MEMOBUS/Modbus communications self-diagnostics [<i>H1-xx = 67</i>] was done while the drive was running.	Stop the drive and do MEMOBUS/Modbus communications self-diagnostics.
Note: If detected, the terminal assigned to <i>H2-01 to H2-03 = 10 [MFDO Function Select = Alarm]</i> will be ON.			

7.5 Minor Faults/Alarms

Code	Name	Causes	Possible Solutions
STo	Safe Torque OFF	Safe Disable inputs H1-HC and H2-HC are open.	<ul style="list-style-type: none"> Make sure that the Safe Disable signal is input from an external source to terminal H1-HC and H2-HC. When the Safe Disable function is not in use, connect terminals H1-HC and H2-HC.
		There is internal damage to the two Safe Disable channels.	Replace the board or the drive. For information about replacing the control board, contact Yaskawa or your nearest sales representative.
Note: <ul style="list-style-type: none"> The drive will not output an alarm signal for this condition. If the drive detects this condition, the terminal set to <i>H2-01 to H2-03 = 21 [MFDO Function Select = Safe Torque OFF]</i> will be ON. 			
Code	Name	Causes	Possible Solutions
SToF	Safe Torque OFF	One of the two terminals H1-HC or H2-HC received the Safe Disable input signal.	<ul style="list-style-type: none"> Make sure that the Safe Disable signal is input from an external source to terminals H1-HC or H2-HC. When the Safe Disable function is not in use, connect terminals H1-HC and H2-HC.
		The Safe Disable input signal is wired incorrectly.	
		There is internal damage to one Safe Disable channel.	Replace the board or the drive. For information about replacing the control board, contact Yaskawa or your nearest sales representative.
Note: <ul style="list-style-type: none"> If the drive detects this error, the terminal assigned to <i>H2-01 to H2-03 = 10 [MFDO Function Select = Alarm]</i> will be ON. 			
Code	Name	Causes	Possible Solutions
TiM	Keypad Time Not Set	You put a battery in the keypad, but you have not set the date and time.	Set the date and time with the keypad.
Note: <ul style="list-style-type: none"> Parameter <i>o4-24 [bAT Detection Selection]</i> enables and disables <i>TiM</i> detection. If the drive detects this error, the terminal set to <i>H2-01 to H2-03 = 10 [MFDO Function Selection = Alarm]</i> will activate. 			
Code	Name	Causes	Possible Solutions
TrPC	IGBT Maintenance Time (90%)	The IGBT is at 90% of its expected performance life.	Replace the IGBT or the drive. Contact Yaskawa or your nearest sales representative for more information.
Note: <ul style="list-style-type: none"> If the drive detects this error, the terminal set to <i>H2-01 to H2-03 = 10 [MFDO Function Selection = Alarm]</i> will activate. 			
Code	Name	Causes	Possible Solutions
UL3	Undertorque Detection 1	A fault occurred on the machine. Example: There is a broken pulley belt.	Examine the machine and remove the cause of the fault.
		The parameters are incorrect for the load.	Adjust <i>L6-02 [Torque Detection Level 1]</i> and <i>L6-03 [Torque Detection Time 1]</i> settings.
Note: <ul style="list-style-type: none"> The drive detects this error if the drive output current is less than the level set in <i>L6-02</i> for longer than <i>L6-03</i>. If the drive detects this error, the terminal assigned to <i>H2-01 to H2-03 = 10 [MFDO Function Select = Alarm]</i> will be ON. If the drive detects this error, it will operate the motor as specified by the Stopping Method set in <i>L6-01 [Torque Detection Selection 1]</i>. 			
Code	Name	Causes	Possible Solutions
UL4	Undertorque Detection 2	A fault occurred on the machine. Example: There is a broken pulley belt.	Examine the machine and remove the cause of the fault.
		The parameters are incorrect for the load.	Adjust <i>L6-05 [Torque Detection Level 2]</i> and <i>L6-06 [Torque Detection Time 2]</i> settings.
Note: <ul style="list-style-type: none"> The drive detects this error if the drive output current is less than the level set in <i>L6-05</i> for longer than <i>L6-06</i>. If detected, the terminal assigned to <i>H2-01 to H2-03 = 10 [MFDO Function Select = Alarm]</i> will be ON. If the drive detects this error, it will operate the motor as specified by the Stopping Method set in <i>L6-04 [Torque Detection Selection 2]</i>. 			
Code	Name	Causes	Possible Solutions
UL5	Mechanical Weakening Detection 2	The drive detected undertorque as specified by the conditions for mechanical weakening detection set in <i>L6-08 [Mechanical Fatigue Detect Select]</i> .	Examine the machine for deterioration.
Note: <ul style="list-style-type: none"> If the drive detects this error, the terminal assigned to <i>H2-01 to H2-03 = 10 [MFDO Function Select = Alarm]</i> will be ON. If the drive detects this error, it will operate the motor as specified by the Stopping Method set in <i>L6-08</i>. 			
Code	Name	Causes	Possible Solutions
Uv	Undervoltage	The drive input power voltage is changing too much.	<ul style="list-style-type: none"> Examine the input power for problems. Make the drive input power stable.
		There is a phase loss in the drive input power.	Correct errors with the wiring for main circuit drive input power.
		There is loose wiring in the drive input power terminals.	Tighten the terminal screws to the correct tightening torque.
		There was a loss of power.	Use a better power supply.

Code	Name	Causes	Possible Solutions
		The main circuit capacitors have become unserviceable.	Examine the capacitor maintenance time in monitor <i>U4-05 [CapacitorMaintenance]</i> . If <i>U4-05</i> is more than 90%, replace the control board or the drive. For information about replacing the control board, contact Yaskawa or your nearest sales representative.
		The drive input power transformer is too small and voltage drops when the power is switched on.	<ul style="list-style-type: none"> • Check for an alarm when a molded-case circuit breaker, Leakage Breaker (ELCB, GFCI, or RCM/RCD) (with overcurrent protective function), or magnetic contactor is ON. • Check the capacity of the drive power supply transformer.
		Air inside the drive is too hot.	Check the ambient temperature of the drive.
		The Charge LED is broken.	Replace the control board or the entire drive. For information about replacing the control board, contact Yaskawa or your nearest sales representative.
<p>Note:</p> <ul style="list-style-type: none"> • The drive detects this error if one of these conditions is correct when the Run command has not been input (while the drive is stopped). <ul style="list-style-type: none"> –The DC bus voltage $< L2-05$ [<i>Undervoltage Detection Lvl (Uv1)</i>]. –The Contactor that prevents inrush current in the drive was opened. –There is low voltage in the control drive input power. • If the drive detects this error, the terminal assigned to <i>H2-01 to H2-03 = 10</i> [<i>MFDO Function Select = Alarm</i>] will be ON. 			

7.6 Parameter Setting Errors

Parameter setting errors occur when multiple parameter settings do not agree, or when parameter setting values are not correct. Refer to the table in this section, examine the parameter setting that caused the error, and remove the cause of the error. You must first correct the parameter setting errors before you can operate the drive. The drive will not send notification signals for the faults and alarms when these parameter setting errors occur.

Code	Name	Causes	Possible Solutions
oPE01	Drive Capacity Setting Error	The value set in <i>o2-04 [Drive Model (KVA Selection)]</i> does not agree with the drive model.	Set <i>o2-04</i> to the correct value.
Code	Name	Causes	Possible Solutions
oPE02	Parameter Range Setting Error	Parameter settings are not in the applicable setting range.	<ol style="list-style-type: none"> Push  to show <i>U1-18 [oPE Fault Parameter]</i>, and find parameters that are not in the applicable setting range. Correct the parameter settings. <p>Note:</p> <ul style="list-style-type: none"> If more than one error occurs at the same time, other <i>oPExx</i> errors have priority over <i>oPE02</i>. If you copy the parameter settings from a drive with software versions PRG: 01021 or earlier, and restore the parameter settings to a drive with PRG: 01022 or later, the drive can detect <i>oPE02</i>. If <i>U1-18 [oPE Fault Parameter]</i> shows <i>n8-36 [HFI Frequency Level for L Tuning]</i>, set <i>n8-36</i> to the default setting and do High Frequency Injection Tuning. The "PRG" column on the nameplate on the right side of the drive identifies the software version. You can also use <i>U1-25 [Software Number FLASH]</i> to identify the software version.
		Set <i>E2-01 ≤ E2-03 [Motor Rated Current (FLA) ≤ Motor No-Load Current]</i> .	<p>Make sure that <i>E2-01 > E2-03</i>.</p> <p>Note:</p> <p>If it is necessary to set <i>E2-01 < E2-03</i>, first lower the value set in <i>E2-03</i>, and then set <i>E2-01</i>.</p>
Code	Name	Causes	Possible Solutions
oPE03	Multi-Function Input Setting Err	The settings for these parameters do not agree: <ul style="list-style-type: none"> <i>F3-10 to F3-25 [Terminal D1 to DF Function Selection]</i> <i>H1-01 to H1-08 [Terminals S1 to S8 Function Selection]</i> <i>H7-01 to H7-04 [Virtual Multi-Function Inputs 1 to 4]</i> 	Correct the parameter settings.
		The settings for the standby mode function do not agree: <ul style="list-style-type: none"> <i>b8-50 = 0 [Standby Mode Selection = Disabled]</i> and <i>H2-xx = 65 [MFDO Function Select = Standby Output]</i> <i>b8-50 = 1 [Enabled]</i> and <i>H2-xx ≠ 65</i> 	Correct the parameter settings.
		The settings for MFDI overlap. <p>Note:</p> <p>This does not include <i>H1-xx = 20 to 2F [MFDI Function Select = External Fault]</i> and <i>[Reserved]</i>.</p>	Set the parameters correctly to prevent MFDI function overlap.
		These pairs of MFDI functions are not set to Digital Inputs (<i>H1-xx, F3-10 to F3-25</i> , and <i>H7-01 to H7-04</i>) at the same time: <ul style="list-style-type: none"> Setting values <i>10 [Up Command]</i> and <i>11 [Down Command]</i> Setting values <i>75 [Up 2 Command]</i> and <i>76 [Down 2 Command]</i> Setting values <i>42 [Run Command (2-Wire Sequence 2)]</i> and <i>43 [FWD/REV (2-Wire Sequence 2)]</i> 	Set the MFDI pairs.
		A minimum of two of these MFDI combinations are set to Digital Inputs (<i>H1-xx, F3-10 to F3-25</i> , and <i>H7-01 to H7-04</i>) at the same time: <ul style="list-style-type: none"> Setting values <i>10 [Up Command]</i> and <i>11 [Down Command]</i> Setting values <i>75 [Up 2 Command]</i> and <i>76 [Down 2 Command]</i> Setting value <i>A [Accel/Decel Ramp Hold]</i> Setting value <i>1E [Reference Sample Hold]</i> Setting values <i>44 to 46 [Add Offset Frequency 1 to 3 (d7-01 to d7-03)]</i> 	Remove the function settings that are not in use.
		The parameter settings are enabled at the same time. <ul style="list-style-type: none"> <i>b5-01 [PID Mode Setting]</i> <i>H1-xx = 10 [Up Command]</i> <i>H1-xx = 11 [Down Command]</i> 	<ul style="list-style-type: none"> Set <i>b5-01 = 0 [Disabled]</i>. Remove the function Up/Down command settings.

Code	Name	Causes	Possible Solutions
		<p>These commands are set in Digital Inputs (H1-xx, F3-10 to F3-25, and H7-01 to H7-04) at the same time:</p> <ul style="list-style-type: none"> Setting values 61 [Speed Search from Fmax] and 62 [Speed Search from Fref] Setting values 65, 66, 7A, 7B [KEB Ride-Thru 1 or 2 Activate] and 68 [High Slip Braking (HSB) Activate] Setting values 16 [Motor 2 Selection] and 1A [Accel/Decel Time Selection 2] Setting values 65, 66 [KEB Ride-Thru 1 Activate] and 7A, 7B [KEB Ride-Thru 2 Activate] Setting values 40, 41 [Forward RUN (2-Wire), Reverse RUN (2-Wire)] and 42, 43 [Run Command (2-Wire Sequence 2), FWD/REV (2-Wire Sequence 2)] Setting values 60 [DC Injection Braking Command] and 6A [Drive Enable] Setting values 16 [Motor 2 Selection] and 75, 76 [Up 2 Command, Down 2 Command] 	Remove the function settings that are not in use.
		<p>Settings for N.C. and N.O. input [H1-xx] for these functions were selected at the same time:</p> <ul style="list-style-type: none"> Setting value 15 [Fast Stop (N.O.)] Setting value 17 [Fast Stop (N.C.)] 	Remove one of the function settings.
		<p>These settings were entered while H1-xx = 2 [External Reference 1/2 Selection]:</p> <ul style="list-style-type: none"> b1-15 = 4 [Frequency Reference Selection 2 = Pulse Train Input] H6-01 ≠ 0 [Terminal RP Pulse Train Function ≠ Frequency Reference] 	Set H6-01 = 0.
		<p>These settings were entered while H1-xx = 2 [External Reference 1/2 Selection]:</p> <ul style="list-style-type: none"> b1-15 = 3 [Option PCB] or b1-16 = 3 [Run Command Selection 2 = Option PCB] No option card is connected to the drive. 	Connect an input option card to the drive.
		<p>These settings were entered while H1-xx = 2 [External Reference 1/2 Selection]:</p> <ul style="list-style-type: none"> b1-15 = 1 [Analog Input] H3-02 ≠ 0 [Terminal A1 Function Selection ≠ Frequency Reference] or H3-10 ≠ 0 [Terminal A2 Function Selection ≠ Frequency Reference] 	Set H3-02 = 0 or H3-10 = 0.
		<p>These parameters are set at the same time:</p> <ul style="list-style-type: none"> H1-xx ≠ 6A [Drive Enable] H2-xx = 38 [Drive Enabled] 	Correct the parameter settings.
		<p>These parameters are set at the same time:</p> <ul style="list-style-type: none"> H6-01 ≠ 3 [PG Speed Feedback (V/F Control)] H1-xx = 7E [Reverse Rotation Identifier] 	Correct the parameter settings.
		<p>These parameters are set at the same time:</p> <ul style="list-style-type: none"> H1-xx = 75/76 [Up 2 /Down 2 Command] H3-01, H3-05, H3-09 = 1 [Terminal A1, A2, A3 Signal Level Select = -10 to +10V (Bipolar Reference)] 	Remove one of the function settings.
		<p>These parameters are set at the same time:</p> <ul style="list-style-type: none"> H1-xx = 62 [Speed Search from Fref] H5-22 = 1 [Speed Search from MODBUS = Enabled] 	Remove one of the function settings.
		<p>These settings do not agree:</p> <ul style="list-style-type: none"> A PG-RT3 option is connected to the drive. H1-xx = 16 [Motor 2 Selection] is set. 	<p>Correct the parameter settings.</p> <p>Note: The Motor Switch function is not available with the PG-RT3 option.</p>
Code	Name	Causes	Possible Solutions
oPE05	Run Cmd/Freq Ref Source Sel Err	The setting to assign the Run command or frequency reference to an option card or the pulse train input is incorrect.	Correct the parameter settings.
		b1-01 = 3 [Frequency Reference Selection 1 = Option PCB] is set, but there is no option card connected to the drive.	Connect an option card to the drive.
		b1-02 = 3 [Run Command Selection 1 = Option PCB] is set, but there is no option card connected to the drive.	Connect an option card to the drive.
		<p>The following parameters are set at the same time:</p> <ul style="list-style-type: none"> b1-01 = 4 [Pulse Train Input] H6-01 ≠ 0 [Terminal RP Pulse Train Function ≠ Frequency Reference] 	Set H6-01 = 0.

7.6 Parameter Setting Errors

Code	Name	Causes	Possible Solutions
		<p>The following parameters are set at the same time:</p> <ul style="list-style-type: none"> $F3-01 = 6$ [Digital Input Function Selection = BCD (5-digit), 0.01 Hz] $F3-03 = 0, 1$ [Digital Input Data Length Select = 8-bit, 12-bit] 	Set $F3-03 = 2$ [16-bit].
		<p>These parameters are set and there is an AI-A3 option card connected to the drive:</p> <ul style="list-style-type: none"> $H1-xx = 2$ [External Reference 1/2 Selection] $b1-15 = 3$ [Frequency Reference Selection 2 = Option PCB] $F2-01 = 0$ [Analog Input Function Selection = 3 Independent Channels] 	Correct the parameter settings.
Code	Name	Causes	Possible Solutions
oPE06	Control Method Selection Error	$A1-02 = 1, 3, \text{ or } 7$ [Control Method Selection = CL-V/f, CLV, CLV/PM], but there is no encoder option connected to the drive.	<ul style="list-style-type: none"> Connect an encoder option to the drive. Set $A1-02$ correctly.
		<p>You supplied external 24 V power to terminals PS-AC when:</p> <ul style="list-style-type: none"> There is an encoder option installed to the drive The drive main circuit power supply is de-energized 	<ol style="list-style-type: none"> De-energize the drive main circuit power supply and the external 24 V power supply to terminals PS-AC. After the keypad display goes out, energize the drive main circuit power supply again. Supply the external 24 V power to terminals PS-AC.
			When you use an encoder option, energize the drive main circuit power supply.
Code	Name	Causes	Possible Solutions
oPE07	Analog Input Selection Error	The settings for $H3-02, H3-06, \text{ and } H3-10$ [MFAI Function Select] and $H7-30$ [Virtual Analog Input Selection] overlap.	<p>Set $H3-02, H3-06, H3-10, \text{ and } H7-30$ correctly to prevent overlap.</p> <p>Note: It is possible to set these functions to multiple analog input terminals at the same time:</p> <ul style="list-style-type: none"> Setting value 0 [Frequency Reference] Setting values F and 1F [Not Used]
		<p>The following parameters are set at the same time:</p> <ul style="list-style-type: none"> $H3-02, H3-06, H3-10, H7-30 = B$ [PID Feedback] $H6-01 = 1$ [Terminal RP Pulse Train Function = PID Feedback Value] 	Remove the function settings that are not in use.
		<p>The following parameters are set at the same time:</p> <ul style="list-style-type: none"> $H3-02, H3-06, H3-10, H7-30 = C$ [PID Setpoint] $H6-01 = 2$ [PID Setpoint Value] 	
		<p>The following parameters are set at the same time:</p> <ul style="list-style-type: none"> $H3-02, H3-06, H3-10, H7-30 = C$ $b5-18 = 1$ [b5-19 PID Setpoint Selection = Enabled] 	
		<p>The following parameters are set at the same time:</p> <ul style="list-style-type: none"> $H6-01 = 2$ $b5-18 = 1$ 	
Code	Name	Causes	Possible Solutions
oPE08	Parameter Selection Error	You set a function that is not compatible with the control method set in $A1-02$ [Control Method Selection].	<ol style="list-style-type: none"> Push  to show $U1-18$ [oPE Fault Parameter], and find parameters that are not in the applicable setting range. Correct the parameter settings. <p>Note: If more than one error occurs at the same time, other oPExx errors have priority over oPE02.</p>
		<p>When $A1-02 = 2$ [Control Method Selection = OLV], you used these parameter settings:</p> <ul style="list-style-type: none"> $n2-02 > n2-03$ [Automatic Freq Regulator Time 1 > Automatic Freq Regulator Time 2] $C4-02 > C4-06$ [Torque Compensation Delay Time > Motor 2 Torque Comp Delay Time] 	<ul style="list-style-type: none"> Set $n2-02 < n2-03$. Set $C4-02 < C4-06$.
		<p>When $A1-02 = 0$ [Control Method Selection = V/f], you used these parameter settings:</p> <ul style="list-style-type: none"> $H6-01 = 3$ [Terminal RP Pulse Train Function = Speed Feedback (V/F Control)] $H1-xx = 16$ [MFDI Function Select = Motor 2 Selection] 	<p>Correct the parameter settings.</p> <p>Note: You cannot use Speed Feedback (V/F Control) with the Motor Switch function.</p>
		<p>When $A1-02 = 5$ [PM Open Loop Vector], you set $E5-02$ to $E5-07$ [PM Motor Parameters] = 0.</p>	<ul style="list-style-type: none"> Set $E5-01$ [PM Motor Code Selection] correctly as specified by the motor. For specialized motors, refer to the motor test report and set $E5-xx$ correctly.

Code	Name	Causes	Possible Solutions
		When $A1-02 = 5$ to 7 [Control Methods for PM Motors], you used these parameter settings: <ul style="list-style-type: none"> $E5-09 = 0.0$ [PM Back-EMF V_{peak} (mV/(rad/s)) = 0.0 mV/(rad/s)] $E5-24 = 0.0$ [PM Back-EMF L-L V_{rms} (mV/rpm) = 0.0 mV/min⁻¹] 	Set $E5-09$ or $E5-24$ to the correct value.
		When $A1-02 = 5$ to 7 , you set $E5-09 \neq 0$ and $E5-24 \neq 0$.	Set $E5-09 = 0$ or $E5-24 = 0$.
		When $A1-02 = 6$ [PM Advanced Open Loop Vector], you used these parameter settings: <ul style="list-style-type: none"> $n8-57 = 0$ [HFI Overlap Selection = Disabled] You set $E1-09$ [Minimum Output Frequency] < the 5% value of $E1-06$. 	Correct the parameter settings.
		When $A1-02 = 6$, you set these parameters: <ul style="list-style-type: none"> $n8-35 = 0$ [Initial Pole Detection Method = Pull-in] $n8-57 = 1$ [Enabled] 	Correct the parameter settings.
		When $A1-02 = 8$ [EZOLV], you used these parameter settings: <ul style="list-style-type: none"> $E9-01 = 1, 2$ [Motor Type Selection = Permanent Magnet (PM), Synchronous Reluctance (SynRM)] $b3-24 = 2$ [Speed Search Method Selection = Current Detection 2] 	When $E9-01 = 1$ or 2 , set $b3-24 = 1$ [Speed Estimation].
Code	Name	Causes	Possible Solutions
oPE09	PID Control Selection Fault	These parameters are set at the same time: <ul style="list-style-type: none"> $b5-15 \neq 0.0$ [PID Sleep Function Start Level $\neq 0.0$ Hz] $b1-03 = 2, 3$ [Stopping Method Selection = DC Injection Braking to Stop, Coast to Stop with Timer] 	<ul style="list-style-type: none"> Set $b5-15 \neq 0.0$. Set $b1-03 = 0, 1$ [Ramp to Stop, Coast to Stop].
		These parameters are set at the same time: <ul style="list-style-type: none"> $b5-01 = 1, 2$ [Enabled (Standard), Enabled (D = Feedforward)] $d2-02 \neq 0.0$ [Frequency Reference Lower Limit $\neq 0.0\%$] $b5-11 = 1$ [PID Output Reverse Selection = Negative Output Accepted] 	Correct the parameter settings.
		These parameters are set at the same time: <ul style="list-style-type: none"> $b5-01 = 3, 4$ [Trim (Fref+PID Out, D = Fdbk), Trim (Fref+PID Out, D = FeedFwd)] $d2-02 \neq 0.0$ has been set. 	Correct the parameter settings.
Note: The drive detects this error if the PID control function selection is incorrect. (When $b5-01 = 1$ to 4 [PID Mode Setting = PID Control Enabled])			
Code	Name	Causes	Possible Solutions
oPE10	V/f Data Setting Error	The parameters that set the V/f pattern do not satisfy these conditions: <ul style="list-style-type: none"> For motor 1: $E1-09 \leq E1-07 < E1-06 \leq E1-11 \leq E1-04$ [Minimum Output Frequency \leq Mid Point A Frequency < Base Frequency \leq Mid Point B Frequency \leq Maximum Output Frequency] For motor 2: $E3-09 \leq E3-07 < E3-06 \leq E3-11 \leq E3-04$ [Minimum Output Frequency \leq Mid Point A Frequency < Base Frequency \leq Mid Point B Frequency \leq Maximum Output Frequency] 	Set the parameters correctly to satisfy the conditions.
Code	Name	Causes	Possible Solutions
oPE11	Carrier Frequency Setting Error	These parameters are set at the same time: <ul style="list-style-type: none"> $C6-05 > 6$ [Carrier Freq Proportional Gain > 6] $C6-04 > C6-03$ [Carrier Frequency Lower Limit > Carrier Frequency Upper Limit] <p>Note: When $C6-05 < 7$, $C6-04$ becomes disabled. The drive sets the carrier frequency to the value set to $C6-03$.</p>	Set $C6-02$ to $C6-05$ correctly.
		$C6-02$ to $C6-05$ settings are not in the applicable setting range.	
Code	Name	Causes	Possible Solutions
oPE13	Pulse Monitor Selection Error	$H6-06 = 101, 102, 105, \text{ or } 116$ [Terminal MP Monitor Selection = Frequency Reference, Output Frequency, Motor Speed, Output Frequency after Soft Starter] has not been set when $H6-07 = 0$ [Terminal MP Frequency Scaling = 0 Hz].	Set $H6-06$ correctly.

7.6 Parameter Setting Errors

Code	Name	Causes	Possible Solutions
oPE15	Torque Control Setting Error	More than one parameter is selecting torque control at the same time. <ul style="list-style-type: none"> $d5-01 = 1$ [Torque Control Selection = Torque Control] $H1-xx = 71$ [MFDI Function Select = Torque Control] 	Correct the parameter settings.
		Droop control and Feed Forward control are enabled at the same time that torque control is selected. <ul style="list-style-type: none"> $d5-01 = 1$ or $H1-xx = 71$ $b7-01 \neq 0.0$ [Droop Control Gain $\neq 0.0\%$] or $n5-01 = 1$ [Feed Forward Control Selection = Enabled] 	Correct the parameter settings.
		KEB Ride-Thru 2 (N.O., N.C.) is enabled at the same time that torque control is selected. <ul style="list-style-type: none"> $d5-01 = 1$ or $H1-xx = 71$ $H1-xx = 7A$ [KEB Ride-Thru 2 Activate (N.C.)] or $H1-xx = 7b$ [KEB Ride-Thru 2 Activate (N.O.)] 	Correct the parameter settings.
		After a momentary power loss, drive operation will enable KEB when torque control is selected. <ul style="list-style-type: none"> $d5-01 = 1$ or $H1-xx = 71$ $L2-01 = 3, 4, 5$ [Power Loss Ride Through Select = Kinetic Energy Backup: L2-02, Kinetic Energy Backup: CPU Power, or Kinetic Energy Backup: DecelStop] 	Correct the parameter settings.
		Optimal deceleration or overexcitation deceleration 2 is enabled at the same time that torque control is selected. <ul style="list-style-type: none"> $d5-01 = 1$ or $H1-xx = 71$ $L3-04 = 2, 5$ [Stall Prevention during Decel = Intelligent (Ignore Decel Ramp), Overexcitation/High Flux 2] 	Correct the parameter settings.
Code	Name	Causes	Possible Solutions
oPE16	Energy Saving Constants Error	The Energy Saving parameters are not set in the applicable setting range.	Make sure that $E5-xx$ is set correctly as specified by the motor nameplate data.
Code	Name	Causes	Possible Solutions
oPE18	Online Tuning Param Setting Err	The parameters that control online tuning are set incorrectly. In OLV control, one of these parameters was set when $n6-01 = 2$ [Online Tuning Selection = Voltage Correction Tuning]: <ul style="list-style-type: none"> $E2-02$ [Motor Rated Slip] is set to 30% of the default setting or lower. $E2-06$ [Motor Leakage Inductance] is set to 50% of the default setting or lower. $E2-03 = 0$ [Motor No-Load Current = 0 A] has been set. 	Set $E2-02$, $E2-03$, and $E2-06$ correctly.
Code	Name	Causes	Possible Solutions
oPE20	PG-F3 Setting Error	The value set in $F1-01$ [Encoder 1 Pulse Count (PPR)] does not agree with the number of encoder pulses.	<ul style="list-style-type: none"> Examine the $F1-01$ value and the number of encoder pulses. Set $F1-01$ correctly.
		The calculation encoder signal frequency at maximum speed is more than 20 kHz.	Decrease the value set for $E1-04$ [Maximum Output Frequency] and make sure that the output frequency of the encoder is not more than 20 kHz.
Code	Name	Causes	Possible Solutions
oPE33	Digital Output Selection Error	These two parameters are set at the same time: <ul style="list-style-type: none"> $H2-60 \neq F$ [Term M1-M2 Secondary Function \neq Not Used] $H2-01 = 1xx$ [Term M1-M2 Function Selection = Inverse output of xx] 	Clear the $H2-01$ to $H2-03 = 1xx$ [Inverse output of xx] settings. Note: It is not possible to set $H2-01$ to $H2-03 = 1xx$ [Inverse output of xx] when using output functions for logic operations ($H2-60$, $H2-63$, $H2-66 \neq F$).
		These two parameters are set at the same time: <ul style="list-style-type: none"> $H2-63 \neq F$ [Term M3-M4 Secondary Function \neq Not Used] $H2-02 = 1xx$ [Term M3-M4 Function Selection = Inverse output of xx] 	
		These two parameters are set at the same time: <ul style="list-style-type: none"> $H2-66 \neq F$ [Term M5-M6 Secondary Function \neq Not Used] $H2-03 = 1xx$ [Term M5-M6 Function Selection = Inverse output of xx] 	
		These parameter pairs are set incorrectly: <ul style="list-style-type: none"> $H2-21$ [Comparator 1 Lower Limit] $>$ $H2-22$ [Comparator 1 Upper Limit] $H2-27$ [Comparator 2 Lower Limit] $>$ $H2-28$ [Comparator 2 Upper Limit] 	

7.7 Auto-Tuning Errors

This table gives information about errors detected during Auto-Tuning. If the drive detects an Auto-Tuning error, the keypad will show the error and the motor will coast to stop. The drive will not send notification signals for faults and alarms when Auto-Tuning errors occur.

Two types of Auto-Tuning errors are: *Endx* and *Erx*. *Endx* identifies that Auto-Tuning has successfully completed with calculation errors. Find and repair the cause of the error and do Auto-Tuning again, or set the motor parameters manually. You can use the drive in the application if you cannot find the cause of the *Endx* error.

Erx identifies that Auto-Tuning was not successful. Find and repair the cause of the error and do Auto-Tuning again.

Code	Name	Causes	Possible Solutions
End1	Excessive Rated Voltage Setting	The torque reference was more than 20% during Auto-Tuning or the no-load current that was measured after Auto-Tuning is more than 80%.	<ul style="list-style-type: none"> Make sure that the input motor nameplate data is correct. Do Auto-Tuning again and correctly set the motor nameplate data. If you can uncouple the motor and load, remove the motor from the machine and do Rotational Auto-Tuning again. If you cannot uncouple the motor and load, use the results from Auto-Tuning.
Code	Name	Causes	Possible Solutions
End2	Iron Core Saturation Coefficient	The motor nameplate data entered during Auto-Tuning is incorrect.	<ul style="list-style-type: none"> Make sure that the input motor nameplate data is correct. Do Auto-Tuning again and correctly set the motor nameplate data.
		Auto-Tuning results were not in the applicable parameter setting range, and <i>E2-07</i> or <i>E2-08</i> [<i>Motor Saturation Coefficient 2</i>] have temporary values.	<ul style="list-style-type: none"> Examine and repair damaged motor wiring. If you can uncouple the motor and load, remove the motor from the machine and do Rotational Auto-Tuning again.
Code	Name	Causes	Possible Solutions
End3	Rated Current Setting Alarm	The rated current value is incorrect.	Do Auto-Tuning again and set the correct rated current shown on the motor nameplate.
Code	Name	Causes	Possible Solutions
End4	Adjusted Slip Calculation Error	The Auto-Tuning results were not in the applicable parameter setting range.	<ul style="list-style-type: none"> Make sure the input motor nameplate data is correct. Do Rotational Auto-Tuning again and correctly set the motor nameplate data. If you cannot uncouple the motor and load, do Stationary Auto-Tuning 2.
		The motor rated slip that was measured after Stationary Auto-Tuning was 0.2 Hz or lower.	
		The motor rated slip that was measured after compensation with <i>E2-08</i> [<i>Motor Saturation Coefficient 2</i>] is not in the applicable range.	
		The secondary resistor measurement results were not in the applicable range.	
Code	Name	Causes	Possible Solutions
End5	Resistance Tuning Error	The Auto-Tuning results of the Line-to-Line Resistance were not in the applicable range.	<ul style="list-style-type: none"> Make sure that the input motor nameplate data is correct. Examine and repair damaged motor wiring.
Code	Name	Causes	Possible Solutions
End6	Leakage Inductance Alarm	The Auto-Tuning results were not in the applicable parameter setting range.	Make sure that the input motor nameplate data is correct, and do Auto-Tuning again.
		<i>A1-02</i> [<i>Control Method Selection</i>] setting is not applicable.	<ul style="list-style-type: none"> Examine the value set in <i>A1-02</i>. Make sure that the input motor nameplate data is correct, and do Auto-Tuning again.
Code	Name	Causes	Possible Solutions
End7	No-Load Current Alarm	The Auto-Tuning results of the motor no-load current value were not in the applicable range.	Examine and repair damaged motor wiring.
		Auto-Tuning results were less than 5% of the motor rated current.	Make sure that the input motor nameplate data is correct, and do Auto-Tuning again.

7.7 Auto-Tuning Errors

Code	Name	Causes	Possible Solutions
End8	HFI Alarm	<ul style="list-style-type: none"> Inductance saliency ratio (<i>E5-07/E5-06</i>) is too small. The drive cannot find the <i>n8-36</i> [<i>HFI Frequency Level for L Tuning</i>] value. 	<ul style="list-style-type: none"> Set the correct value on the motor nameplate <i>E5-xx</i> [<i>PM motor parameters</i>] or do Stationary/Rotational Auto-Tuning, and then do High Frequency Injection Tuning again. When it is necessary to set <i>n8-35 = 1</i> [<i>Initial Pole Detection Method = High Frequency Injection</i>] or <i>n8-57 = 1</i> [<i>HFI Overlap Selection = Enabled</i>], make sure that there is no unusual noise in the low speed range (10% or less) and that the motor does not rotate in reverse at start. <p>If there is unusual noise in the low speed range (10% or less), increase <i>n8-41</i> in increments of 0.5. Set <i>n8-41 > 0.0</i> for IPM motors.</p> <p>Note: If the drive detects <i>End8</i>, it will automatically set <i>n8-35 = 0</i> [<i>Pull-in</i>] and <i>n8-57 = 0</i> [<i>Disabled</i>]. Do not change the settings unless necessary.</p>
End9	Initial Pole Detection Alarm	The drive cannot calculate the correct value for <i>n8-84</i> [<i>Polarity Detection Current</i>] during High Frequency Injection Tuning.	<ul style="list-style-type: none"> Set the correct value on the motor nameplate <i>E5-xx</i> [<i>PM motor parameters</i>] or do Stationary/Rotational Auto-Tuning, and then do High Frequency Injection Tuning again. When <i>n8-35 = 1</i> [<i>Initial Pole Detection Method = High Frequency Injection</i>] or <i>n8-57 = 1</i> [<i>HFI Overlap Selection = Enabled</i>], make sure that the motor does not rotate in reverse at start. <p>If there is unusual noise in the low speed range (10% or less), increase <i>n8-41</i> in increments of 0.5. Set <i>n8-41 > 0.0</i> for IPM motors.</p> <p>Note: If the drive detects <i>End9</i>, it will automatically set <i>n8-35 = 0</i> [<i>Pull-in</i>] and <i>n8-57 = 0</i> [<i>Disabled</i>]. Do not change the settings unless necessary.</p>
Er-01	Motor Data Error	<p>The motor nameplate data entered during Auto-Tuning is incorrect.</p> <p>The combination of the motor rated power and motor rated current do not match.</p> <p>The combination of the motor rated current that was entered during Auto-Tuning and <i>E2-03</i> [<i>Motor No-Load Current</i>] do not match.</p> <p>The combination of the setting values of Motor Base Frequency and Motor Base Speed do not match.</p>	<ul style="list-style-type: none"> Make sure that the motor nameplate data is correct. Do Auto-Tuning again and correctly set the motor nameplate data. Examine the combination of drive capacity and motor output. Do Auto-Tuning again, and correctly set the motor rated power and motor rated current. Examine the motor rated current and the no-load current. Set <i>E2-03</i> correctly. Do Auto-Tuning again, and correctly set the motor rated current. <p>Do Auto-Tuning again, and correctly set the Motor Base Frequency and Motor Base Speed.</p>
Er-02	Drive in an Alarm State	<p>The motor nameplate data entered during Auto-Tuning is incorrect.</p> <p>You did Auto-Tuning while the drive had a minor fault or alarm.</p> <p>There is a defective motor cable or cable connection.</p> <p>The load is too large.</p> <p>The drive detected a minor fault during Auto-Tuning.</p>	<ul style="list-style-type: none"> Make sure that the motor nameplate data entered in Auto-Tuning is correct. Do Auto-Tuning again and correctly set the motor nameplate data. <p>Clear the minor fault or alarm and do Auto-Tuning again.</p> <p>Examine and repair motor wiring.</p> <ul style="list-style-type: none"> Decrease the load. Examine the machine area to see if, for example, the motor shaft is locked. <ol style="list-style-type: none"> Stop Auto-Tuning. Examine the minor fault code and remove the cause of the problem. Do Auto-Tuning again.
Er-03	STOP Button was Pressed	During Auto-Tuning,  was pushed.	Auto-Tuning did not complete correctly. Do Auto-Tuning again.

Code	Name	Causes	Possible Solutions
Er-04	Line-to-Line Resistance Error	The Auto-Tuning results were not in the applicable parameter setting range.	<ul style="list-style-type: none"> Examine and repair motor wiring. Disconnect the machine from the motor and do Rotational Auto-Tuning again.
		Auto-Tuning did not complete in a pre-set length of time.	
		There is a defective motor cable or cable connection.	<ul style="list-style-type: none"> Make sure that the input motor nameplate data is correct. Do Auto-Tuning again and correctly set the motor nameplate data.
		The motor nameplate data entered during Auto-Tuning is incorrect.	
Code	Name	Causes	Possible Solutions
Er-05	No-Load Current Error	The Auto-Tuning results were not in the applicable parameter setting range.	<ul style="list-style-type: none"> Examine and repair motor wiring. Disconnect the machine from the motor and do Rotational Auto-Tuning again.
		Auto-Tuning did not complete in a pre-set length of time.	
		The motor nameplate data entered during Auto-Tuning is incorrect.	<ul style="list-style-type: none"> Make sure that the input motor nameplate data is correct. Do Auto-Tuning again and correctly set the motor nameplate data.
		Rotational Auto-Tuning was done with a load that was more than 30% of the rating connected to the motor.	<ul style="list-style-type: none"> Disconnect the machine from the motor and do Rotational Auto-Tuning again. If you cannot uncouple the motor and load, make sure that the load is less than 30% of the motor rating. If a mechanical brake is installed in the motor, release the brake during Rotational Auto-Tuning.
Code	Name	Causes	Possible Solutions
Er-08	Rated Slip Error	The motor nameplate data entered during Auto-Tuning is incorrect.	<ul style="list-style-type: none"> Make sure that the input motor nameplate data is correct. Do Auto-Tuning again and correctly set the motor nameplate data.
		Auto-Tuning did not complete in a pre-set length of time.	<ul style="list-style-type: none"> Examine and repair the motor wiring. If the motor and machine are connected during Rotational Auto-Tuning, decouple the motor from the machinery.
		The Auto-Tuning results were not in the applicable parameter setting range.	
		Rotational Auto-Tuning was done with a load that was more than 30% of the rating connected to the motor.	<ul style="list-style-type: none"> Disconnect the machine from the motor and do Rotational Auto-Tuning again. If you cannot uncouple the motor and load, make sure that the load is less than 30% of the motor rating. If a mechanical brake is installed in the motor, release the brake during Rotational Auto-Tuning.
Code	Name	Causes	Possible Solutions
Er-09	Acceleration Error	The motor did not accelerate for the specified acceleration time.	<ol style="list-style-type: none"> Increase the value set in <i>C1-01 [Acceleration Time 1]</i>. Disconnect the machine from the motor and do Rotational Auto-Tuning again.
		The value of <i>L7-01</i> or <i>L7-02 [Forward/Reverse Torque Limit]</i> is small.	Increase the value set in <i>L7-01</i> or <i>L7-02</i> .
		Rotational Auto-Tuning was done with a load that was more than 30% of the rating connected to the motor.	<ul style="list-style-type: none"> Disconnect the machine from the motor and do Rotational Auto-Tuning again. If you cannot uncouple the motor and load, make sure that the load is less than 30% of the motor rating. If a mechanical brake is installed in the motor, release the brake during Rotational Auto-Tuning.
Code	Name	Causes	Possible Solutions
Er-10	Motor Direction Error	There is defective drive and motor wiring.	Examine and repair motor wiring.
		There is defective drive and encoder wiring.	Examine and repair the wiring to the encoder.
		The direction of the motor and the setting of <i>F1-05 [PG 1 Rotation Selection]</i> are opposite.	Set <i>F1-05</i> correctly.
		The machine pulled the motor to rotate in the opposite direction.	Disconnect the machine from the motor and do Rotational Auto-Tuning again.
		When the torque reference is 100% or higher, the sign of the speed reference was opposite of the detected speed.	
Code	Name	Causes	Possible Solutions
Er-11	Motor Speed Error	The torque reference during acceleration is too high (100%).	<ul style="list-style-type: none"> Increase the value set in <i>C1-01 [Acceleration Time 1]</i>. Disconnect the machine from the motor and do Rotational Auto-Tuning again.

7.7 Auto-Tuning Errors

Code	Name	Causes	Possible Solutions
Er-12	Current Detection Error	There is a phase loss in the drive input power. (U/T1, V/T2, W/T3)	Examine and repair motor wiring.
		The current exceeded the current rating of the drive.	<ul style="list-style-type: none"> Check the motor wiring for any short circuits between the wires. Check and turn ON any magnetic contactors used between motors. Replace the control board or the drive. For information about replacing the control board, contact Yaskawa or your nearest sales representative.
		The output current is too low.	
		You tried Auto-Tuning without a motor connected to the drive.	Connect the motor and do Auto-Tuning.
		There was a current detection signal error.	Replace the control board or the drive. For information about replacing the control board, contact Yaskawa or your nearest sales representative.
Code	Name	Causes	Possible Solutions
Er-13	Leakage Inductance Alarm	The motor rated current value is incorrect.	Correctly set the rated current indicated on the motor nameplate and perform Auto-Tuning again.
		The drive could not complete tuning for leakage inductance in fewer than 300 seconds.	Examine and repair motor wiring.
Code	Name	Causes	Possible Solutions
Er-14	Motor Speed Error 2	The motor speed was more than two times the amplitude of speed reference during Inertia Tuning.	Decrease the value set in <i>C5-01 [ASR Proportional Gain 1]</i> .
Code	Name	Causes	Possible Solutions
Er-15	Torque Saturation Error	During Inertia Tuning, the output torque was more than the value set in <i>L7-01 to L7-04 [Torque Limit]</i> .	<ul style="list-style-type: none"> Increase the value set in <i>L7-01 to L7-04 [Torque Limit]</i> as much as possible. Decrease the values set for the frequency and amplitude of the test signals used when doing inertia tuning. First, decrease the test signal amplitude, and then do Inertia Tuning. If the error continues, decrease the test signal frequency and do Inertia Tuning again.
Code	Name	Causes	Possible Solutions
Er-16	Inertia ID Error	The inertia found by the drive was too small or too large during Inertia Tuning (10% or less, or 50000% or more).	<ul style="list-style-type: none"> Decrease the values set for the frequency and amplitude of the test signals used when doing inertia tuning. First, decrease the test signal amplitude, and then do Inertia Tuning. If the error continues, decrease the test signal frequency and do Inertia Tuning again. Correctly set the motor inertia as specified by the motor, and do Inertia Tuning again.
Code	Name	Causes	Possible Solutions
Er-17	Reverse Prohibited Error	<i>b1-04 = 1 [Reverse Operation Selection = Reverse Disabled]</i> Note: You cannot do Inertia Tuning if the drive cannot rotate the motor in reverse.	<ol style="list-style-type: none"> Enable reverse in the target machine. Set <i>b1-04 = 0 [Reverse Enabled]</i>. Do Inertia Tuning again.
Code	Name	Causes	Possible Solutions
Er-18	Back EMF Error	The result of the induced voltage tuning was not in the applicable range.	<ol style="list-style-type: none"> Make sure that the input motor nameplate data is correct. Do Auto-Tuning again and correctly set the motor nameplate data.
Code	Name	Causes	Possible Solutions
Er-19	PM Inductance Error	The Auto-Tuning results of the PM motor inductance were not in the applicable range.	<ol style="list-style-type: none"> Make sure that the input motor nameplate data is correct. Do Auto-Tuning again and correctly set the motor nameplate data.
Code	Name	Causes	Possible Solutions
Er-20	Stator Resistance Error	The Auto-Tuning results of the PM Motor Stator Resistance were not in the applicable range.	<ol style="list-style-type: none"> Make sure that the input motor nameplate data is correct. Do Auto-Tuning again and correctly set the motor nameplate data.
Code	Name	Causes	Possible Solutions
Er-21	Z Pulse Correction Error	The motor is wired incorrectly.	<ol style="list-style-type: none"> Repair motor and encoder wiring errors. Do Z Pulse Offset Tuning again.
		The encoder is wired incorrectly.	
		You did Auto-Tuning on a coasting motor.	<ol style="list-style-type: none"> Wait for the motor to fully stop. Do Z Pulse Offset Tuning again.
		The setting for the direction of the encoder motor rotation is incorrect.	<ol style="list-style-type: none"> Set the direction of motor rotation of the encoder in <i>F1-05 [Encoder 1 Rotation Selection]</i> correctly. Do Z Pulse Offset Tuning again.
		The number of encoder pulses is incorrect.	<ol style="list-style-type: none"> Set the number of encoder pulses in <i>F1-01 [Encoder 1 Pulse Count (PPR)]</i> correctly. Do Z Pulse Offset Tuning again.

Code	Name	Causes	Possible Solutions
		The motor Inertia is too large.	Increase the value set in <i>n8-02 [Pole Alignment Current Level]</i> .
		Parameter <i>b1-04 = 1 [Reverse Operation Selection = Reverse Disabled]</i> and you did Z Pulse Offset Tuning.	<ul style="list-style-type: none"> If the machine prevents reverse rotation, disconnect the motor from the machinery, set <i>b1-04 = 0 [Reverse Enabled]</i>, then do Z Pulse Offset Tuning. When tuning is complete, set <i>b1-04 = 1 [Reverse Disabled]</i>. If the machine does not prevent reverse rotation, set <i>b1-04 = 0</i> and do Z Pulse Offset Tuning.
		The motor vibrates during tuning.	<ul style="list-style-type: none"> Increase the values set in <i>n8-03 [Pole Position Detection Time]</i> and <i>n8-04 [Pole Alignment Time]</i>. Decrease the value set in <i>n8-02 [Pole Alignment Current Level]</i>.
		The encoder is damaged.	<ul style="list-style-type: none"> Examine the signal output from the encoder. Replace the encoder.
Code	Name	Causes	Possible Solutions
Er-25	HighFreq Inject Param Tuning Err	The motor data is incorrect.	<p>Do Stationary Auto-Tuning again.</p> <p>Note: If the drive detects <i>Er-25</i> after doing Stationary Auto-Tuning, the motor may not be able to use high frequency injection control. Contact Yaskawa or your nearest sales representative for more information.</p>

7.8 Backup Function Operating Mode Display and Errors

◆ Operating Mode Display

When you use the backup function from the LCD keypad, the keypad shows messages according to the current operation. These indicators do not show that an error has occurred.

Keypad Display	Name	Display	Status
Drive and Keypad mismatch. Should the parameters be restored?	Detection of inconsistency between the drive and keypad	Normally displayed	The drive detected the connection of a keypad from a different drive. Select [Yes] to copy parameters backed up in the keypad to the connected drive.
Restore Restore from keypad	Restoring parameters	Flashing	The parameters stored in the keypad have been restored to the drive.
End	Backup/restore/verify operation ended normally	Normally displayed	The parameter backup, restore, or verify operation ended normally.
Backup Backup from Drive	Backing up parameters	Flashing	The parameters stored in the drive are being backed up to the keypad.
Verify Keypad & Drive	Verifying parameters	Flashing	The parameter settings stored in the keypad and the parameter settings in the drive match or are being compared.

◆ Backup Function Runtime Errors

When an error occurs, the keypad shows a code to identify the error.

The table in this section show the error codes. Refer to these tables to remove the cause of the errors.

Note:

Push any key on the keypad to clear an error.

Code	Name	Causes	Possible Solutions
CPyE	Error Writing Data	Parameter restore did not end correctly.	Restore the parameters.
Code	Name	Causes	Possible Solutions
CSEr	Control Mode Mismatch	The keypad is broken.	Replace the keypad.
Code	Name	Causes	Possible Solutions
dFPS	Drive Model Mismatch	You tried to restore parameters to a different drive model than the one that you backed up.	<ol style="list-style-type: none"> Examine the drive model that you used to back up the parameters. Restore the parameters.
Code	Name	Causes	Possible Solutions
iFEr	Keypad Communication Error	There was a communications error between the keypad and the drive.	Examine the connector or cable connection.
Code	Name	Causes	Possible Solutions
ndAT	Error Received Data	The parameter settings for model and specifications (power supply voltage and capacity) are different between the keypad and the drive.	<ol style="list-style-type: none"> Make sure that drive model and the value set in <i>o2-04 [Drive Model (KVA) Selection]</i> agree. Restore the parameters.
		The parameters are not stored in the keypad.	<ol style="list-style-type: none"> Connect a keypad that has the correct parameters. Restore the parameters.
Code	Name	Causes	Possible Solutions
PWEr	DWEZ Password Mismatch	The password set in the backup operation with <i>qx-xx [DriveWorksEZ Parameters]</i> and <i>rx-xx [DriveWorksEZ Connections]</i> is incorrect.	Set the DWEZ PC software password supplied by Yaskawa for the DWEZ program user ID downloaded to the drive.
Note: <i>U8-11 and U8-12 [DWEZ Versions 1 and 2] show the user ID of the DWEZ program.</i>			
Code	Name	Causes	Possible Solutions
rdEr	Error Reading Data	You tried to back up the data when <i>o3-02 = 0 [Copy Allowed Selection = Disabled]</i> .	Set <i>o3-02 = 1 [Enabled]</i> and back up again.
Code	Name	Causes	Possible Solutions
vAEr	Voltage Class, Capacity Mismatch	The power supply specifications or drive capacity parameter settings are different between the keypad and the drive.	<ol style="list-style-type: none"> Make sure that drive model and the value set in <i>o2-04 [Drive Model (KVA) Selection]</i> agree. Restore the parameters.
Code	Name	Causes	Possible Solutions
vFyE	Parameters do not Match	The parameters that are backed up in the keypad and the parameters in the drive are not the same.	<ol style="list-style-type: none"> Restore or backup the parameter again. Verify the parameters.

7.9 Diagnosing and Resetting Faults

When a fault occurs and the drive stops, do the procedures in this section to remove the cause of the fault, then re-energize the drive.

◆ Fault and Power Loss Occur at the Same Time

WARNING! Crush Hazard. Wear eye protection when you do work on the drive. If you do not use correct safety equipment, it can cause serious injury or death.

WARNING! Electrical Shock Hazard. After the drive blows a fuse or trips an RCM/RCD, do not immediately energize the drive or operate peripheral devices. Wait for the time specified on the warning label at a minimum and make sure that all indicators are OFF. Then check the wiring and peripheral device ratings to find the cause of the problem. If you do not know the cause of the problem, contact Yaskawa before you energize the drive or peripheral devices. If you do not fix the problem before you operate the drive or peripheral devices, it can cause serious injury or death.

1. Supply power to the control circuit from the external 24 V input.
2. Use monitor parameters *U2-xx [Fault Trace]* to show the fault code and data about the operating status of the drive immediately before the fault occurred.
3. Use the information in the Troubleshooting tables to remove the fault.

Note:

1. To find the faults that were triggered, check the fault history in *U2-02 [Previous Fault]*. To find information about drive status (such as frequency, current, and voltage) when the faults were triggered, check *U2-03 to U2-20*.
2. If the fault display stays after you re-energize the drive, remove the cause of the fault and reset.

◆ Fault Occurs Without Power Loss

1. Examine the fault code shown on the keypad.
2. Use the information in the Troubleshooting tables to remove the fault.
3. Do a fault reset.

◆ Fault Reset

If a fault occurs, you must remove the cause of the fault and re-energize the drive. [Table 7.3](#) lists the different methods to reset the drive after a fault.

Table 7.3 Fault Reset Methods

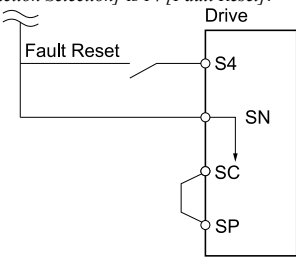
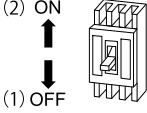
Methods	Description
Method 1	While the keypad is showing the fault or alarm code, push F1 (Reset) or  on the keypad.
Method 2	<p>Switch ON the MFDI terminal set to <i>H1-xx = 14 [MFDI Function Select = Fault Reset]</i>.</p> <p>Note: The default setting for <i>H1-04 [Terminal S4 Function Selection]</i> is <i>14 [Fault Reset]</i>.</p> 
Method 3	<ol style="list-style-type: none"> 1. De-energize the drive main circuit power supply. 2. Energize the drive again after the keypad display goes out. 

Note:

If the drive receives a Run command from a communication option or control circuit terminal, the drive will not reset the fault. Remove the Run command then try to clear the fault. If you do a fault reset when the drive has a Run command, the keypad will show minor fault *CrST [Remove RUN Command to Reset]*.

7.10 Troubleshooting Without Fault Display

If the drive or motor operate incorrectly, but the keypad does not show a fault or error code, refer to the items this section.

- Motor hunting and oscillation
- Unsatisfactory motor torque
- Unsatisfactory speed precision
- Unsatisfactory motor torque and speed response
- Motor noise

◆ Typical Problems







Symptom	Ref.
The Parameter Settings Will Not Change	394
The Motor Does Not Rotate after You Enter a Run Command	395
The Motor Rotates in the Opposite Direction from the Run Command	396
The Motor Rotates in Only One Direction	396
The Motor Is Too Hot	396
The Correct Auto-Tuning Mode Is Not Available	397
The Motor Stalls during Acceleration or Accel/Decel Time Is Too Long	397
The Drive Frequency Reference Is Different than the Controller Frequency Reference Command	398
The Motor Is Not Stable When Using a PM Motor	398
There Is Too Much Motor Oscillation and the Rotation Is Irregular	398
Deceleration Takes Longer than Expected when You Enable Dynamic Braking	398
The Load Falls When a Brake Is Applied	399
There Is Audible Noise from the Drive or Motor Cables when You Energize the Drive	399
The Ground Fault Circuit Interrupter (RCM/ RCD) Trips During Run	399
Motor Rotation Causes Unexpected Audible Noise from Connected Machinery	399
Motor Rotation Causes Oscillation or Hunting	400
PID Output Fault	400
The Starting Torque Is Not Sufficient	400
The Motor Rotates after You Shut Off Drive Output	400
The Output Frequency Is Lower Than the Frequency Reference	400
The Motor Is Making an Audible Noise	401
The Motor Will Not Restart after Power Loss	401

◆ The Parameter Settings Will Not Change

Causes	Possible Solutions
The drive is operating the motor (the drive is in Drive Mode).	Stop the drive and change to Programming Mode.
Parameter $A1-01 = 0$ [Access Level Selection = Operation Only].	Set $A1-01 = 2$ [Access Level Selection = Advanced Level] or $A1-01 = 3$ [Expert Level].
Parameter $H1-xx = 1B$ [MFDI Function Select = Programming Lockout].	Activate the terminals to which $H1-xx = 1B$ is set, and then change the parameters.

Causes	Possible Solutions
You entered an incorrect password in <i>A1-04 [Password]</i> .	<ul style="list-style-type: none"> Enter the correct password to <i>A1-04</i> again. If you forgot the password, set the password again with <i>A1-04</i> and <i>A1-05 [Password Setting]</i>. <p>Note: If you set the password, you cannot change these parameters until the password aligns:</p> <ul style="list-style-type: none"> <i>A1-01 [Access Level Selection]</i> <i>A1-02 [Control Method Selection]</i> <i>A1-03 [Initialize Parameters]</i> <i>A1-06 [Application Preset]</i> <i>A1-07 [DriveWorksEZ Function Selection]</i> <i>A2-01 to A2-32 [User Parameter 1 to User Parameter 32]</i>
The drive detected <i>Uv [Undervoltage]</i> .	<ul style="list-style-type: none"> View <i>U1-07 [DC Bus Voltage]</i> to see the power supply voltage. Examine the main circuit wiring.

◆ The Motor Does Not Rotate After Entering Run Command

Causes	Possible Solutions
The drive is not in Drive Mode.	<ol style="list-style-type: none"> Make sure that the keypad shows [Rdy]. If the keypad does not show [Rdy], go back to the Home screen.
The drive stopped,  was pushed, and changed the Run command source to the keypad.	<p>Do one of these two:</p> <ul style="list-style-type: none"> Push . Re-energize the drive. <p>Note: Set <i>o2-01 = 0 [LO/RE Key Function Selection = Disabled]</i> to prevent changing the Run command source with .</p>
Auto-Tuning completed.	<p>Go back to the Home screen on the keypad.</p> <p>Note: When Auto-Tuning completes, the drive changes to Programming Mode. The drive will not accept a Run command unless the drive is in Drive Mode.</p>
The drive received a fast stop command.	Turn off the fast stop input signal.
The settings for the source that supplies the Run command are incorrect.	Set <i>b1-02 [Run Command Selection 1]</i> correctly.
The frequency reference source is set incorrectly.	Set <i>b1-01 [Frequency Reference Selection 1]</i> correctly.
There is defective wiring in the control circuit terminals.	<ul style="list-style-type: none"> Correctly wire the drive control circuit terminals. View <i>U1-10 [Input Terminal Status]</i> for input terminal status.
The settings for voltage input and current input of the master frequency reference are incorrect.	<p>Examine these analog input terminal signal level settings:</p> <ul style="list-style-type: none"> Terminal A1: DIP switch S1-1 and <i>H3-01 [Terminal A1 Signal Level Select]</i> Terminal A2: DIP switch S1-2 and <i>H3-09 [Terminal A2 Signal Level Select]</i> Terminal A3: DIP switch S4, S1-3 and <i>H3-05 [Terminal A3 Signal Level Select]</i>
The selection for the sinking/sourcing mode and the internal/external power supply is incorrect.	<ul style="list-style-type: none"> For sinking mode, close the circuit between terminals SC-SP with a wire jumper. For sourcing mode, close the circuit between terminals SC-SN with a wire jumper. For external power supply, remove the wire jumper.
The frequency reference is too low.	<ul style="list-style-type: none"> View <i>U1-01 [Freq Reference]</i>. Increase the frequency reference to a value higher than <i>E1-09 [Minimum Output Frequency]</i>.
The MFAI setting is incorrect.	<ul style="list-style-type: none"> Make sure that the functions set to the MFAI are correct. The frequency reference is 0 when <i>H3-02, H3-10, H3-06 = 1 [MFAI Function Select = Frequency Gain]</i> and voltage (current) is not input. View <i>U1-13 to U1-15 [Terminal A1, A2, A3 Input Voltage]</i> to see if the analog input values set to terminals A1, A2, and A3 are applicable.
 was pushed.	<p>Turn the Run command OFF then ON from an external input.</p> <p>Note: When you push  during operation, the drive will ramp to stop. Set <i>o2-02 = 0 [STOP Key Function Selection = Disabled]</i> to disable the  function.</p>
The 2-wire sequence and 3-wire sequence are set incorrectly.	<ul style="list-style-type: none"> Set one of the parameters <i>H1-03 to H1-08 [Terminals S3 to S8 Function Select]</i> to 0 [<i>3-Wire Sequence</i>] to enable the 3-wire sequence. If a 2-wire sequence is necessary, make sure that <i>H1-03 to H1-08 ≠ 0</i>.

◆ The Motor Rotates in the Opposite Direction from the Run Command

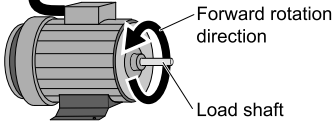
Causes	Possible Solutions
The phase wiring between the drive and motor is incorrect.	<ul style="list-style-type: none"> Examine the wiring between the drive and motor. Connect drive output terminals U/T1, V/T2, and W/T3 in the correct sequence to agree with motor terminals U, V, and W. Switch two motor cables U, V, and W to reverse motor direction.
The forward direction for the motor is set incorrectly.	<ul style="list-style-type: none"> Connect drive output terminals U/T1, V/T2, and W/T3 in the correct sequence to agree with motor terminals U, V, and W. Switch two motor cables U, V, and W to reverse motor direction. <div style="text-align: center;">  <p>Figure 7.1 Forward Rotating Motor</p> <p>Note:</p> <ul style="list-style-type: none"> For Yaskawa motors, the forward direction is counterclockwise when looking from the motor shaft side. Refer to the motor specifications, and make sure that the forward rotation direction is correct for the application. The forward rotation direction of motors can be different for different motor manufacturers and types. </div>
The signal connections for forward run and reverse run on the drive control circuit terminals and control panel side are incorrect.	Correctly wire the control circuit.
The motor is running at almost 0 Hz and the Speed Search estimated the speed to be in the opposite direction.	Set $b3-14 = 0$ [<i>Bi-directional Speed Search = Disabled</i>], then the drive will only do speed search in the specified direction.

◆ The Motor Rotates in Only One Direction

Causes	Possible Solutions
The drive will not let the motor rotate in reverse.	Set $b1-04 = 0$ [<i>Reverse Operation Selection = Reverse Enabled</i>].
The drive did not receive a Reverse run signal and 3-Wire sequence is selected.	Activate the terminals to which $H1-xx = 0$ [<i>3-Wire Sequence</i>] is set, and then enable reverse operation.

◆ The Motor Is Too Hot

Causes	Possible Solutions
The load is too heavy.	<ul style="list-style-type: none"> Decrease the load. Increase the acceleration and deceleration times. Examine the values set in $L1-01$ [<i>Motor Overload (oL1) Protection</i>], $L1-02$ [<i>Motor Overload Protection Time</i>], and $E2-01$ [<i>Motor Rated Current (FLA)</i>]. Use a larger motor. <p>Note: The motor also has a short-term overload rating. Examine this rating carefully before setting drive parameters.</p>
The motor is running continuously at a very low speed.	<ul style="list-style-type: none"> Change the run speed. Use a drive-dedicated motor.
The drive is operating in a vector control mode, but Auto-Tuning has not been done.	<ul style="list-style-type: none"> Do Auto-Tuning. Calculate motor parameter and set motor parameters. Set $A1-02 = 0$ [<i>Control Method Selection = V/f Control</i>].
The voltage insulation between motor phases is not sufficient.	<ul style="list-style-type: none"> Use a motor with a voltage tolerance that is higher than the maximum voltage surge. Use a drive-dedicated motor that is rated for use with AC drives for applications that use a motor on drives rated higher than 400 V class. Install an AC reactor on the output side of the drive and set $C6-02 = 1$ [<i>Carrier Frequency Selection = 2.0 kHz</i>]. <p>Note: When the motor is connected to the drive output terminals U/T1, V/T2, and W/T3, surges occur between the drive switching and the motor coils. These surges can be three times the drive input power supply voltage (600 V for a 200 V class drive, 1200 V for a 400 V class drive).</p>
The air around the motor is too hot.	<ul style="list-style-type: none"> Measure the ambient temperature. Decrease the temperature in the area until it is in the specified temperature range.
The motor fan stopped or is clogged.	<ul style="list-style-type: none"> Clean the motor fan. Make the drive environment better.

◆ The Correct Auto-Tuning Mode Is Not Available

Causes	Possible Solutions
The desired Auto-Tuning mode is not available for the selected control mode.	Change the motor control method with parameter <i>A1-02</i> [Control Method Selection].

◆ The Motor Stalls during Acceleration or Accel/Decel Time Is Too Long

Causes	Possible Solutions
The drive and motor system reached the torque limit or current suppression will not let the drive accelerate.	<ul style="list-style-type: none"> Decrease the load. Use a larger motor. <p>Note: Although the drive has a Stall Prevention function and a Torque Compensation Limit function, accelerating too fast or trying to drive a load that is too large can exceed the limits of the motor.</p>
Torque limit is set incorrectly.	Set the torque limit correctly.
The acceleration time setting is too short.	Check the values set in <i>C1-01</i> , <i>C1-03</i> , <i>C1-05</i> , or <i>C1-07</i> [Acceleration Time] and set them to applicable values.
The load is too heavy.	<ul style="list-style-type: none"> Increase the acceleration time. Examine the mechanical brake and make sure that it is fully releasing. Decrease the load to make sure that the output current stays less than the motor rated current. Use a larger motor. <p>Note: • In extruder and mixer applications, the load can increase as the temperature decreases. • Although the drive has a Stall Prevention function and a Torque Compensation Limit function, accelerating too fast or trying to drive a load that is too large can exceed the limits of the motor.</p>
The frequency reference is low.	<ul style="list-style-type: none"> Examine <i>E1-04</i> [Maximum Output Frequency] and increase the setting if it is set too low. Examine <i>U1-01</i> [Frequency Reference] for the correct frequency reference. Examine the multi-function input terminals to see if a frequency reference signal switch has been set. Examine the low gain level set in <i>H3-03</i>, <i>H3-11</i>, <i>H3-07</i> [Terminal A1, A2, A3 Gain Setting] if you use MFAL.
The frequency reference is set incorrectly.	<p>When <i>H3-02</i>, <i>H3-10</i>, <i>H3-06</i> = 1 [MFAI Function Select = Frequency Gain] are set, see if voltage (current) has been set.</p> <ul style="list-style-type: none"> Check the values set in <i>H3-02</i>, <i>H3-10</i>, and <i>H3-06</i>. Use <i>U1-13</i> to <i>U1-15</i> [Terminal A1, A2, A3 Input Voltage] to make sure that the analog input values set to terminals A1, A2, and A3 are applicable.
The motor characteristics and drive parameter settings are not compatible.	<ul style="list-style-type: none"> Set the correct V/f pattern to agree with the characteristics of the motor. Examine the V/f pattern set in <i>E1-03</i> [V/f Pattern Selection]. Perform Rotational Auto-Tuning.
The drive is operating in vector control mode, but Auto-Tuning is not completed.	<ul style="list-style-type: none"> Do Auto-Tuning. Calculate motor data and reset motor parameters. Set <i>A1-02</i> = 0 [Control Method Selection = V/f Control].
Parameter <i>A1-02</i> = 4 [Control Method Selection = Advanced Open Loop Vector] and the speed estimation response is too slow.	Increase the value set in <i>n4-65</i> [Flux Estimate Response@High Freq] in 0.1-unit increments.
The Stall Prevention level during acceleration setting is too low.	<p>Increase the value set in <i>L3-02</i> [Stall Prevent Level during Accel].</p> <p>Note: If the <i>L3-02</i> value is too low, the acceleration time can be unsatisfactorily long.</p>
The Stall Prevention level during run setting is too low.	<p>Increase the value set in <i>L3-06</i> [Stall Prevent Level during Run].</p> <p>Note: If the <i>L3-06</i> value is too low, speed will decrease while the drive outputs torque.</p>
Drive reached the limitations of the V/f motor control method.	<ul style="list-style-type: none"> When the motor cable is longer than 50 m (164 ft.), do Auto-Tuning for line-to-line resistance. Set the V/f pattern to "High Starting Torque". Use a Vector Control method. <p>Note: V/f control method does not provide high torque at low speeds.</p>

◆ The Drive Frequency Reference Is Different than the Controller Frequency Reference Command

Causes	Possible Solutions
The analog input gain and bias for the frequency reference input are set incorrectly.	Examine the gain and bias settings for the analog inputs that set the frequency reference. <ul style="list-style-type: none"> Terminal A1: H3-03 [Terminal A1 Gain Setting], H3-04 [Terminal A1 Bias Setting] Terminal A2: H3-11 [Terminal A2 Gain Setting], H3-12 [Terminal A2 Bias Setting] Terminal A3: H3-07 [Terminal A3 Gain Setting], H3-08 [Terminal A3 Bias Setting]
The drive is receiving frequency bias signals from analog input terminals A1 to A3 and the sum of all signals makes the frequency reference.	<ul style="list-style-type: none"> Examine parameters H3-02, H3-10, H3-06 [MFAI Function Select]. If two or more of these parameters are set to 0, change the settings. Use U1-13 to U1-15 [Terminal A1, A2, A3 Input Voltage] to make sure that the analog input values set to terminals A1, A2, and A3 are applicable.
The motor rotates faster than the frequency reference at low speed.	<ul style="list-style-type: none"> Decrease the value set in n4-70 [Speed Command Comp @ Low Freq] in increments of 0.1 Hz. <p>Note: If you set the value too low, the motor can rotate in reverse.</p> Set E1-09 > 0 [Minimum Output Frequency]. <p>Note: • The recommended setting for E1-09 is 0.5 Hz. • When frequency reference < E1-09, the drive output will turn OFF.</p>
PID control is enabled.	<p>If PID control is not necessary, set b5-01 = 0 [PID Mode Setting = Disabled].</p> <p>Note: When PID control is enabled, the drive adjusts the output frequency as specified by the target value. The drive will only accelerate to the maximum output frequency set in E1-04 [Maximum Output Frequency] while PID control is active.</p>

◆ The Motor Speed Is Not Stable When Using a PM Motor

Causes	Possible Solutions
E5-01 [PM Motor Code Selection] is set incorrectly.	Refer to "Motor Performance Fine-Tuning" in the technical manual.
The drive is operating the motor at more than the specified speed control range.	Examine the speed control range and adjust the speed.
The motor is hunting.	Adjust these parameters to have the largest effect: <ul style="list-style-type: none"> n8-55 [Motor to Load Inertia Ratio] n8-45 [Speed Feedback Detection Gain] C4-02 [Torque Compensation Delay Time]
Hunting occurs at start.	Increase the value set in C2-01 [S-Curve Time @ Start of Accel].
Too much current is flowing through the drive.	Set E5-01 [PM Motor Code Selection] correctly as specified by the motor. For special-purpose motors, enter the correct value to E5-xx as specified by the motor test report.
Operation is not stable when n8-57 = 1 [HF1 Overlap Selection = Enabled].	<ul style="list-style-type: none"> Do High Frequency Injection Auto-Tuning. Decrease the value set in n8-41 [HF1 P Gain] in increments of 0.5. <p>Note: Set n8-41 > 0.0 for IPM motors.</p>

◆ There Is Too Much Motor Oscillation and the Rotation Is Irregular

Causes	Possible Solutions
Unsatisfactory balance of motor phases.	<ul style="list-style-type: none"> Make sure that the drive input power voltage supplies stable power. Set L8-05 = 0 [Input Phase Loss Protect Select = Disabled].
The motor is hunting.	<ul style="list-style-type: none"> Set n1-01 = 1 [Hunting Prevention Selection = Enabled]. Increase the value of n2-01 [SpdFeedbackDetectCtr (AFR) Gain] or n2-02 [SpdFeedbackDetCtr(AFR)TimeConst1].

◆ Deceleration Takes Longer Than Expected When Dynamic Braking Is Enabled

Causes	Possible Solutions
The stall prevention during deceleration setting is incorrect.	<ul style="list-style-type: none"> Examine the setting for L3-04 [Decel Stall Prevention Selection]. When the drive has a dynamic braking option installed, set L3-04 = 0 [Disabled]. If the drive detects ov [Overvoltage], set L3-04 = 3 [General Purpose w/ DB resistor].
The deceleration time setting is too long.	Set C1-02, C1-04, C1-06, or C1-08 [Deceleration Times] to applicable values.

Causes	Possible Solutions
The motor torque is not sufficient.	Use a larger motor. Note: If these items are correct, the demand on the motor is more than the motor capacity: • Parameter settings are correct. • The drive does not detect <i>ov</i> [<i>Overvoltage</i>].
The drive and motor system reached the torque limit.	<ul style="list-style-type: none"> Examine the values set in L7-01 to L7-04 [<i>Torque Limit</i>] and increase them if necessary. Note: If the torque limit is enabled, deceleration time can increase because the drive cannot output more torque than the limit. <ul style="list-style-type: none"> If H3-02, H3-10, H3-06 = 10, 11, 12, 15 [<i>MFAI Function Select = Torque Limit</i>] has been set, examine the settings for the MFALs. <ul style="list-style-type: none"> Examine the values set in H3-02, H3-10, and H3-06. Use U1-13 to U1-15 [<i>Terminal A1, A2, A3 Input Voltage</i>] to make sure that the analog input values set to terminals A1, A2, and A3 are applicable.
The load is more than the internal torque limit as specified by the drive rated current.	Replace the drive with a larger capacity model.

◆ The Load Falls When a Brake Is Applied

Causes	Possible Solutions
The open/close timing of the brake is incorrect.	Refer to "Notes on Controlling the Brake when Using the Hoist Application Preset" in the technical manual and take appropriate measures.
The DC injection braking is not sufficient.	Increase the value set in b2-02 [<i>DC Injection Braking Current</i>].

◆ There Is Audible Noise from the Drive or Motor Cables when You Energize the Drive

Causes	Possible Solutions
The relay switching in the drive is making too much noise.	<ul style="list-style-type: none"> Use C6-02 [<i>Carrier Frequency Selection</i>] to decrease the carrier frequency. Connect a noise filter to the input side of the drive power supply. Connect a noise filter to the output side of the drive. Isolate the control circuit wiring from the main circuit wiring. Use a metal cable gland to wire the drive. Shield the periphery of the drive with metal. Make sure that the drive and motor are grounded correctly. Make sure that ground faults have not occurred in the wiring or motor.

◆ Residual Current Monitoring/Detection (RCM/RCD) Trips During Run

Causes	Possible Solutions
There is too much leakage current from the drive.	<ul style="list-style-type: none"> Increase the RCM/RCD sensitivity or use RCM/RCD with a higher threshold. Use C6-02 [<i>Carrier Frequency Selection</i>] to decrease the carrier frequency. Decrease the length of the cable used between the drive and the motor. Install a noise filter or AC reactor on the output side of the drive. Set C6-02 = 1 [<i>2.0 kHz</i>] when connecting an AC reactor. Disable the internal EMC filter.

◆ Motor Rotation Causes Unexpected Audible Noise from Connected Machinery

Causes	Possible Solutions
The carrier frequency and the resonant frequency of the connected machinery are the same.	<ul style="list-style-type: none"> Adjust C6-02 to C6-05 [<i>Carrier Frequency</i>]. Set C6-02 = 1 to 6 [<i>Carrier Frequency Selection = Frequency other than Swing PWM</i>]. Note: If C6-02 = 7 to A [<i>Carrier Frequency Selection = Swing PWM</i>], the drive will not know if the noise comes from the drive or the machine.
The drive output frequency and the resonant frequency of the connected machinery are the same.	<ul style="list-style-type: none"> Adjust d3-01 to d3-04 [<i>Jump Frequency</i>]. Put the motor on a rubber pad to decrease vibration.

◆ Motor Rotation Causes Oscillation or Hunting

Causes	Possible Solutions
The frequency reference is assigned to an external source, and there is electrical interference in the signal.	Make sure that electrical interference does not have an effect on the signal lines. <ul style="list-style-type: none"> • Isolate control circuit wiring from main circuit wiring. • Use twisted-pair cables or shielded wiring for the control circuit. • Increase the value of H3-13 [Analog Input Filter Time Constant].
The cable between the drive and motor is too long.	<ul style="list-style-type: none"> • Do Auto-Tuning. • Make the wiring as short as possible.
The PID parameters are not sufficiently adjusted.	Adjust b5-xx [PID control].

◆ PID Output Fault

Causes	Possible Solutions
There is no PID feedback input.	<ul style="list-style-type: none"> • Examine the MFAI terminal settings. • See if H3-02, H3-10, H3-06 = B [MFAI Function Select = PID Feedback] is set. • Make sure that the MFAI terminal settings agree with the signal inputs. • Examine the connection of the feedback signal. • Make sure that b5-xx [PID Control] is set correctly. <p>Note: If there is no PID feedback input to the terminal, the detected value is 0, which causes a PID fault and also causes the drive to operate at maximum frequency.</p>
The detection level and the target value do not agree.	Use H3-03, H3-11, H3-07 [Terminal A1, A2, A3 Gain Setting] to adjust PID target and feedback signal scaling. <p>Note: PID control keeps the difference between the target value and detection value at 0. Set the input level for the values relative to each other.</p>
Reverse drive output frequency and speed detection. When output frequency increases, the sensor detects a speed decrease.	Set b5-09 = 1 [PID Output Level Selection = Reverse output (reverse acting)].

◆ The Starting Torque Is Not Sufficient

Causes	Possible Solutions
Auto-Tuning has not been done in vector control method.	Do Auto-Tuning.
The control method was changed after doing Auto-Tuning.	Do Auto-Tuning again.
Stationary Auto-Tuning for Line-to-Line Resistance was done.	Do Rotational Auto-Tuning.

◆ The Motor Rotates after the Drive Output Is Shut Off

Causes	Possible Solutions
DC Injection Braking is too low and the drive cannot decelerate correctly.	<ul style="list-style-type: none"> • Increase the value set in b2-02 [DC Injection Braking Current]. • Increase the value set in b2-04 [DC Inject Braking Time at Stop].
The stopping method makes the drive coast to stop.	Set b1-03 = 0 or 2 [Stopping Method Selection = Ramp to Stop, DC Injection Braking to Stop].

◆ The Output Frequency Is Lower Than the Frequency Reference

Causes	Possible Solutions
The frequency reference is in the Jump frequency range.	Adjust d3-01 to d3-03 [Jump Frequency 1 to 3] and d3-04 [Jump Frequency Width]. <p>Note: Enabling the Jump frequency prevents the drive from outputting the frequencies specified in the Jump range.</p>
The upper limit for the frequency reference has been exceeded.	Set E1-04 [Maximum Output Frequency] and d2-01 [Frequency Reference Upper Limit] to the best values for the application. <p>Note: This calculation supplies the upper value for the output frequency: $E1-04 \times d2-01 / 100$</p>
A large load triggered Stall Prevention function during acceleration.	<ul style="list-style-type: none"> • Decrease the load. • Adjust L3-02 [Stall Prevent Level during Accel].

Causes	Possible Solutions
$L3-01 = 3$ [Stall Prevent Select during Accel = ILim Mode] has been set.	<ol style="list-style-type: none"> 1. Check whether the V/f pattern and motor parameter settings are appropriate, and set them correctly. 2. If this does not solve the problem, and it is not necessary to limit the current level of stall during acceleration, adjust $L3-02$. 3. If this does not solve the problem, set $L3-01 = 1$ [Enabled].
The motor is rotating at this speed: $b2-01$ [DC Injection/Zero SpeedThreshold] \leq Motor Speed $< E1-09$ [Minimum Output Frequency]	<ul style="list-style-type: none"> • Set $b1-21 = 1$ [CLV Start Selection = Accept Run command at any speed]. • Set $E1-09 < b2-01$.

◆ The Motor Is Making an Audible Noise

Causes	Possible Solutions
100% of the rated output current of the drive was exceeded while operating at low speeds.	<ul style="list-style-type: none"> • If the sound is coming from the motor, set $L8-38 = 0$ [Carrier Frequency Reduction = Disabled]. • If $\alpha L2$ [Drive Overloaded] occurs frequently after setting $L8-38 = 0$, replace the drive with a high-capacity drive.

◆ The Motor Will Not Restart after a Loss of Power

Causes	Possible Solutions
The drive did not receive a Run command after applying power.	<ul style="list-style-type: none"> • Examine the sequence and wiring that enters the Run command. • Set up a relay to make sure that the Run command stays enabled during a loss of power.
For applications that use 3-wire sequence, the momentary power loss continued for a long time, and the relay that keeps the Run command has been switched off.	Examine the wiring and circuitry for the relay that keeps the Run command enabled during the momentary power loss ride-thru time.

Periodic Inspection and Maintenance

This chapter gives information about how to examine and maintain drives in use, how to replace cooling fans and other parts, and how to store drives.

8.1	Section Safety	404
8.2	Inspection.....	406
8.3	Maintenance	408
8.4	Replace Cooling Fans and Circulation Fans.....	410
8.5	Replace the Drive	442
8.6	Replace the Keypad Battery	447
8.7	Storage Guidelines	449

8.1 Section Safety

DANGER

Electrical Shock Hazard

Do not examine, connect, or disconnect wiring on an energized drive. Before servicing, disconnect all power to the equipment and wait for the time specified on the warning label at a minimum. The internal capacitor stays charged after the drive is de-energized. The charge indicator LED extinguishes when the DC bus voltage decreases below 50 Vdc. When all indicators are OFF, remove the covers before measuring for dangerous voltages to make sure that the drive is safe.

If you do work on the drive when it is energized, it will cause serious injury or death from electrical shock.

Disconnect all power to the drive and wait for the time specified on the warning label before you remove covers. Check the drive for dangerous voltages before servicing or repair work.

If you do work on the drive when it is energized and there is no cover over the electronic circuits, it will cause serious injury or death from electrical shock. The drive has internal capacitors that stay charged after you de-energize the drive.

WARNING

Electrical Shock Hazard

The motor will run after you de-energize the drive. PM motors can generate induced voltage to the terminal of the motor after you de-energize the drive.

If you touch a motor that is moving or energized, it can cause serious injury or death.

Do not operate the drive when covers are missing. Replace covers and shields before you operate the drive. Use the drive only as specified by the instructions.

Some figures in this section include drives without covers or safety shields to more clearly show the inside of the drive. If covers or safety shields are missing from the drive, it can cause serious injury or death.

Always ground the motor-side grounding terminal.

If you do not ground the equipment correctly, it can cause serious injury or death if you touch the motor case.

Only let approved personnel install, wire, maintain, examine, replace parts, and repair the drive.

If personnel are not approved, it can cause serious injury or death.

Do not wear loose clothing or jewelry when you do work on the drive. Tighten loose clothing and remove all metal objects, for example watches or rings.

Loose clothing can catch on the drive and jewelry can conduct electricity and cause serious injury or death.

Fire Hazard

Tighten all terminal screws to the correct tightening torque.

Connections that are too loose or too tight can cause incorrect operation and damage to the drive. Incorrect connections can also cause death or serious injury from fire.

Damage to Equipment

Do not apply incorrect voltage to the main circuit of the drive. Operate the drive in the specified range of the input voltage on the drive nameplate.

Voltages that are higher than the permitted nameplate tolerance can cause damage to the drive.

Fire Hazard

Do not put flammable or combustible materials on top of the drive and do not install the drive near flammable or combustible materials. Attach the drive to metal or other noncombustible material.

Flammable and combustible materials can start a fire and cause serious injury or death.

⚠ WARNING**Electrical Shock Hazard**

Do not modify the drive body or drive circuitry.

Modifications to drive body and circuitry can cause serious injury or death, will cause damage to the drive, and will void the warranty. Yaskawa is not responsible for modifications of the product made by the user.

Sudden Movement Hazard

Make sure that you align the phase order for the drive and motor when you connect the motor to drive output terminals U/T1, V/T2, and W/T3.

If the phase order is incorrect, it can cause the motor to run in reverse. If the motor accidentally runs in reverse, it can cause serious injury or death.

⚠ CAUTION**Burn Hazard**

Do not touch a hot drive heatsink. De-energize the drive, wait for a minimum of 15 minutes, then make sure that the heatsink is cool before you replace the cooling fans.

If you touch a hot drive heatsink, it can burn you.

NOTICE**Damage to Equipment**

When you touch the drive and circuit boards, make sure that you observe correct electrostatic discharge (ESD) procedures.

If you do not follow procedures, it can cause ESD damage to the drive circuitry.

Use the instructions in this manual to replace the cooling fans. When you do maintenance on the fans, replace all the fans to increase product life.

If you install the fans incorrectly, it can cause damage to the drive.

Make sure that all connections are correct after you install the drive and connect peripheral devices.

Incorrect connections can cause damage to the drive.

Do not energize and de-energize the drive more frequently than one time each 30 minutes.

If you frequently energize and de-energize the drive, it can cause drive failure.

Do not operate a drive or connected equipment that has damaged or missing parts.

You can cause damage to the drive and connected equipment.

Note:

Do not use unshielded cable for control wiring. Use shielded, twisted-pair wires and ground the shield to the ground terminal of the drive. Incorrect wiring can cause electrical interference and unsatisfactory system performance.

8.2 Inspection

Power electronics have limited life and can show changes in performance and deterioration of performance after years of use in usual conditions. To help prevent these problems, it is important to do preventive maintenance and regular inspection, and replace parts on the drive.

Drives contain different types of power electronics, for example power transistors, semiconductors, capacitors, resistors, fans, and relays. The electronics in the drive are necessary for correct motor control.

Follow the inspection lists in this chapter as a part of a regular maintenance program.

Note:

Examine the drive one time each year at a minimum.

The operating conditions, environmental conditions, and use conditions will have an effect on the examination frequency for connected equipment.

Examine the drive more frequently if you use the drive in bad conditions or in these conditions:

- High ambient temperatures
- Frequent starting and stopping
- Changes in the AC power supply or load
- Too much vibration or shock loading
- Dust, metal dust, salt, sulfuric acid, or chlorine atmospheres
- Unsatisfactory storage conditions.

◆ Recommended Daily Inspection

Table 8.1 gives information about the recommended daily inspection for Yaskawa drives. Examine the items in Table 8.1 each day to make sure that the components do not become unserviceable or fail. Make a copy of this checklist and put a check mark in the “Checked” column after each inspection.

Table 8.1 Daily Inspection Checklist

Inspection Area	Inspection Points	Corrective Action	Checked
Motor	Examine for unusual oscillation or noise coming from the motor.	<ul style="list-style-type: none"> • Check the load coupling. • Measure motor vibration. • Tighten all loose components. 	
Cooling System	Examine for unusual heat from the drive or motor and visible discoloration.	<ul style="list-style-type: none"> • Check for a load that is too heavy. • Tighten loose screws. • Check for a dirty heatsink or motor. • Measure the ambient temperature. 	
	Examine the cooling fans, circulation fans, and circuit board cooling fans.	<ul style="list-style-type: none"> • Check for a clogged or dirty fan. • Use the performance life monitor to check for correct fan operation. 	
Surrounding Environment	Make sure that the installation environment is applicable.	Remove the source of contamination or correct unsatisfactory environment.	
Load	Make sure that the drive output current is not more than the motor or drive rating for an extended period of time.	<ul style="list-style-type: none"> • Check for a load that is too heavy. • Check the correct motor parameter settings. 	
Power Supply Voltage	Examine main power supply and control voltages.	<ul style="list-style-type: none"> • Correct the voltage or power supply to agree with nameplate specifications. • Verify all main circuit phases. 	

◆ Recommended Periodic Inspection

Table 8.2 to Table 8.6 give information about the recommended periodic inspections for Yaskawa drives. Examine the drive one time each year at a minimum. The operating conditions, environmental conditions, and use conditions will have an effect on the examination frequency for connected equipment. You must use your experience with the application to select the correct inspection frequency for each drive installation. Periodic inspections will help to prevent performance deterioration and product failure. Make a copy of this checklist and put a check mark in the “Checked” column after each inspection.

DANGER! Electrical Shock Hazard. Do not examine, connect, or disconnect wiring on an energized drive. Before servicing, disconnect all power to the equipment and wait for the time specified on the warning label at a minimum. The internal capacitor stays charged after the drive is de-energized. The charge indicator LED extinguishes when the DC bus voltage decreases below 50 Vdc. When all indicators are OFF, remove the covers before measuring for dangerous voltages to make sure that the drive is safe. If you do work on the drive when it is energized, it will cause serious injury or death from electrical shock.

Table 8.2 Main Circuit Periodic Inspection Checklist

Inspection Area	Inspection Points	Corrective Action	Checked
General	<ul style="list-style-type: none"> Examine equipment for discoloration from too much heat or deterioration. Examine for damaged parts. 	<ul style="list-style-type: none"> Replace damaged components as necessary. The drive does not have many serviceable parts and it could be necessary to replace the drive. 	
	Examine for dirt, unwanted particles, or dust on components.	<ul style="list-style-type: none"> Examine enclosure door seal. Use a vacuum cleaner to remove unwanted particles and dust without touching the components. If you cannot remove unwanted particles and dust with a vacuum cleaner, replace the components. 	
Conductors and Wiring	<ul style="list-style-type: none"> Examine wiring and connections for discoloration or damage. Examine wiring and connections for discoloration from too much heat. Examine wire insulation and shielding for discoloration and wear. 	Repair or replace damaged wiring.	
Terminal Block	Examine terminals for stripped, damaged, or loose connections.	<ul style="list-style-type: none"> Tighten loose screws. Replace damaged screws or terminals. <p>Note: On drive models, 2056, 2070, 4031, and 4038, you cannot replace the hex screws.</p>	
Electromagnetic Contactors and Relays	<ul style="list-style-type: none"> Examine contactors and relays for too much noise during operation. Examine coils for signs of too much heat, such as melted or broken insulation. 	<ul style="list-style-type: none"> Check coil voltage for overvoltage or undervoltage conditions. Replace broken relays, contactors, or circuit boards that you can remove. 	
Dynamic Braking Option	Examine the insulation for discoloration from too much heat.	If there is discoloration in the option, check to make sure that the wiring is not damaged. A small quantity of discoloration is not a problem.	
Electrolytic Capacitor	<ul style="list-style-type: none"> Examine for leaks, discoloration, or cracks. Examine if the cap has come off, if there is swelling, or if there are leaks from broken sides. 	The drive does not have many serviceable parts and it could be necessary to replace the drive.	
Diodes, IGBT (Power Transistor)	Examine for dust or other unwanted material collected on the surface.	Use a vacuum cleaner to remove unwanted particles and dust without touching the components.	

Table 8.3 Motor Periodic Inspection Checklist

Inspection Area	Inspection Points	Corrective Action	Checked
Operation Check	Check for increased vibration or unusual noise.	Stop the motor and contact approved maintenance personnel as necessary.	

Table 8.4 Control Circuit Periodic Inspection Checklist

Inspection Area	Inspection Points	Corrective Action	Checked
General	<ul style="list-style-type: none"> Examine terminals for stripped, damaged, or loose connections. Make sure that all terminals have been correctly tightened. 	<ul style="list-style-type: none"> Tighten loose screws. Replace damaged screws or terminals. If terminals are integral to a circuit board, it could be necessary to replace the control board or the drive. 	
Circuit Boards	<ul style="list-style-type: none"> Check for odor, discoloration, or rust. Make sure that all connections are correctly fastened. Make sure that the surface of the circuit board does not have dust or oil mist. 	<ul style="list-style-type: none"> Tighten loose connections. Use a vacuum cleaner to remove unwanted particles and dust without touching the components. If you cannot remove unwanted particles and dust with a vacuum cleaner, replace the components. Do not use solvents to clean the board. The drive does not have many serviceable parts and it could be necessary to replace the drive. 	

Table 8.5 Cooling System Periodic Inspection Checklist

Inspection Area	Inspection Points	Corrective Action	Checked
Cooling fan	<ul style="list-style-type: none"> Check for unusual oscillation or unusual noise. Check for damaged or missing fan blades. 	Clean or replace the fans as necessary.	
Heatsink	<ul style="list-style-type: none"> Examine for dust or other unwanted material collected on the surface. Examine for dirt. 	Use a vacuum cleaner to remove unwanted particles and dust without touching the components.	
Air Duct	Examine air intake, exhaust openings and make sure that there are no unwanted materials on the surface.	Clear blockages and clean air duct as necessary.	

Table 8.6 Keypad Periodic Inspection Checklist

Inspection Area	Inspection Points	Corrective Action	Checked
General	<ul style="list-style-type: none"> Make sure that the keypad shows the data correctly. Examine for dust or other unwanted material that collected on components in the area. 	<ul style="list-style-type: none"> If you have problems with the display or the keys, contact Yaskawa or your nearest sales representative. Clean the keypad. 	

8.3 Maintenance

The drive Maintenance Monitors keep track of component wear and tell the user when the end of the estimated performance life is approaching. The Maintenance Monitors prevent the need to shut down the full system for unexpected problems. Users can set alarm notifications for the maintenance periods for these drive components:

- Cooling fan
- Electrolytic Capacitor
- Soft charge bypass relay
- IGBT

Contact Yaskawa or your nearest sales representative for more information about part replacement.

◆ Replaceable Parts

DANGER! Electrical Shock Hazard. Do not examine, connect, or disconnect wiring on an energized drive. Before servicing, disconnect all power to the equipment and wait for the time specified on the warning label at a minimum. The internal capacitor stays charged after the drive is de-energized. The charge indicator LED extinguishes when the DC bus voltage decreases below 50 Vdc. When all indicators are OFF, remove the covers before measuring for dangerous voltages to make sure that the drive is safe. If you do work on the drive when it is energized, it will cause serious injury or death from electrical shock.

You can replace these parts of the drive:

- Control circuit terminal board
- Cooling fan, circulation fan
- Keypad

If there is a failure in the main circuit, replace the drive.

If the drive is in the warranty period, contact Yaskawa or your nearest sales representative before you replace parts. Yaskawa reserves the right to replace or repair the drive as specified by the Yaskawa warranty policy.

◆ Part Replacement Guidelines

Table 8.7 shows the standard replacement period for replacement parts. When you replace these parts, make sure that you use Yaskawa replacement parts for the applicable model and design revision number of your drive.

Table 8.7 Standard Replacement Period

Parts	Standard Replacement Period
Cooling Fan	10 years
Electrolytic Capacitor ^{*1}	10 years

*1 If there is damage to parts that you cannot repair or replace, replace the drive.

Note:

These conditions are provided for the purpose of replacing parts to maintain performance. Unsatisfactory conditions or heavy use will make it necessary for you to replace some parts more frequently than other parts. Performance life estimate is based on the yearly average of these use conditions.

- Ambient air temperature
 - IP00/UL Open Type: 40 °C (104 °F)
 - IP20/UL Open Type: 40 °C (104 °F)
 - IP20/UL Type 1: 30 °C (86 °F)
 - IP55/UL Type 12 Heatsink External Mounting; front side: 40 °C (104 °F)
 - IP55/UL Type 12 Heatsink External Mounting; back side: 30 °C (86 °F)
- Load factor
 - 80%
- Operating rate
 - 24 hours a day

◆ Monitors that Display the Lifespan of Drive Components

The drive keypad shows percentage values for the replacement parts to help you know when you must replace those components. Use the monitors in Table 8.8 to check replacement periods. When the monitor value is 100%, the component is at the end of its useful life and there is an increased risk of drive malfunction. Yaskawa recommends that you check the maintenance period regularly to make sure that you get the maximum performance life of the drive.

Table 8.8 Performance Life Monitors

Monitor No.	Parts	Description
U4-03	Cooling fan	Shows the total operation time of fans as 0 to 99999 hours. After this value is 99999, the drive automatically resets it to 0.
U4-04		Shows the total fan operation time as a percentage of the specified maintenance period.
U4-05	Electrolytic Capacitor	Shows the total capacitor usage time as a percentage of the specified maintenance period.
U4-06	Soft charge bypass relay	Shows the number of times the drive is energized as a percentage of the performance life of the inrush circuit.
U4-07	IGBT	Shows the percentage of the maintenance period for the IGBTs.

◆ Alarm Outputs for Maintenance Monitors

You can use $H2-xx$ [MFDO Function Selection] to send a message that tells you when a specified component is near the end of its performance life estimate. Set the applicable value to $H2-xx$ as shown in Table 8.9 for your component.

When the specified component is near the end of its performance life estimate, the MFDO terminals set for $H2-xx = 2F$ [Maintenance Notification] will activate, and the keypad will show an alarm that identifies the component to replace.

Table 8.9 Maintenance Period Alarms

Display	Alarm Name	Cause	Possible Solutions	MFDO (Setting Value in H2-xx)
LT-1	Cooling Fan Maintenance Time	The cooling fan is at 90% of its expected performance life.	Replace the cooling fan, then set $o4-03 = 0$ [Fan Operation Time Setting = 0 h] to reset the cooling fan operation time.	2F
LT-2	Capacitor Maintenance Time	The capacitors for the main circuit and control circuit are at 90% of expected performance life.	Replace the board or the drive. Contact Yaskawa or your nearest sales representative to replace the board.	
LT-3	SoftChargeBypassRelay Maintenance Time	The soft charge bypass relay is at 90% of its performance life estimate.	Replace the board or the drive. Contact Yaskawa or your nearest sales representative to replace the board.	
LT-4	IGBT Maintenance Time (50%)	The IGBT is at 50% of its expected performance life.	Check the load, carrier frequency, and output frequency.	
TrPC	IGBT Maintenance Time (90%)	The IGBT is at 90% of its expected performance life.	Replace the IGBT or the drive.	10

◆ Related Parameters

Replace the component, then set $o4-03$, $o4-05$, $o4-07$, and $o4-09$ [Maintenance Setting] = 0 to reset the Maintenance Monitor. If these parameters are not reset after the corresponding parts have been replaced, the Maintenance Monitor function will continue to count down the performance life from the value that was reached with the old part. If the Maintenance Monitor is not reset, the drive will not have the correct value of the performance life for the new component.

Note:

The maintenance period changes for different operating environments.

Table 8.10 Maintenance Setting Parameters

No.	Name	Function
o4-03	Fan Operation Time Setting	Sets the value from which to start the cumulative drive cooling fan operation time in 10-hour units. Note: When $o4-03 = 30$, the drive will count the operation time for the cooling fan from 300 hours and $U4-03$ [Cooling Fan Op Time] will show 300 h.
o4-05	Capacitor Maintenance Setting	Sets the value from which to start the count for the main circuit capacitor maintenance period as a percentage.
o4-07	Softcharge Relay Maintenance Set	Sets as a percentage the value from which to start the count for the soft charge bypass relay maintenance time.
o4-09	IGBT Maintenance Setting	Sets the value from which to start the count for the IGBT maintenance period as a percentage.

8.4 Replace Cooling Fans and Circulation Fans

CAUTION! *Injury to Personnel. Some fan units are not easily accessible from a standing position. Make sure that you can safely and comfortably remove and replace the fan. If you try to remove a fan that you cannot easily access, the fan unit can fall and cause minor to moderate injury.*

NOTICE: *Use the instructions in this manual to replace the cooling fans. When you do maintenance on the fans, replace all the fans to increase product life. If you install the fans incorrectly, it can cause damage to the drive.*

◆ Cooling Fans and Circulation Fans by Drive Model

Table 8.11 Cooling Fans and Circulation Fans (Three-Phase 200 V Class)

Model	Cooling Fan	Circulation Fan	Procedure	Ref.
2004 - 2012	-	-	-	-
2018, 2021	1	-	Procedure A	410
2030, 2042	2	-	Procedure B	412
2056 - 2082	2	-	Procedure C	415
2110 - 2211	2	-	Procedure D	417
2257 - 2313	2	-	Procedure E	419
2360, 2415	3	1	Procedure F	421

Table 8.12 Cooling Fans and Circulation Fans (Three-Phase 400 V Class)

Model	Cooling Fan	Circulation Fan	Circuit Board Cooling Fan	Procedure	Ref.
4002 - 4005	-	-	-	-	-
4007 - 4012	1	-	-	Procedure A	410
4018, 4023	2	-	-	Procedure B	412
4031 - 4060	2	-	-	Procedure C	415
4075 - 4168	2	-	-	Procedure D	417
4208 - 4296	2	-	-	Procedure E	419
4371	2	1	-	Procedure F	421
4389	3	1	-	Procedure F	421
4453 - 4675	2	1	2	Procedure G	426
4810 - 4H12	4	2	4	Procedure H	434

◆ Fan Replacement (Procedure A)

DANGER! *Electrical Shock Hazard. Do not examine, connect, or disconnect wiring on an energized drive. Before servicing, disconnect all power to the equipment and wait for the time specified on the warning label at a minimum. The internal capacitor stays charged after the drive is de-energized. The charge indicator LED extinguishes when the DC bus voltage decreases below 50 Vdc. When all indicators are OFF, remove the covers before measuring for dangerous voltages to make sure that the drive is safe. If you do work on the drive when it is energized, it will cause serious injury or death from electrical shock.*

CAUTION! *Burn Hazard. Do not touch a hot drive heatsink. De-energize the drive, wait for a minimum of 15 minutes, then make sure that the heatsink is cool before you replace the cooling fans. If you touch a hot drive heatsink, it can burn you.*

NOTICE: *Use the instructions in this manual to replace the cooling fans. When you do maintenance on the fans, replace all the fans to increase product life. If you install the fans incorrectly, it can cause damage to the drive.*

■ Fan Removal

1. To remove the fan finger guard from the drive, push the hooks on the left and right sides of it and pull up.

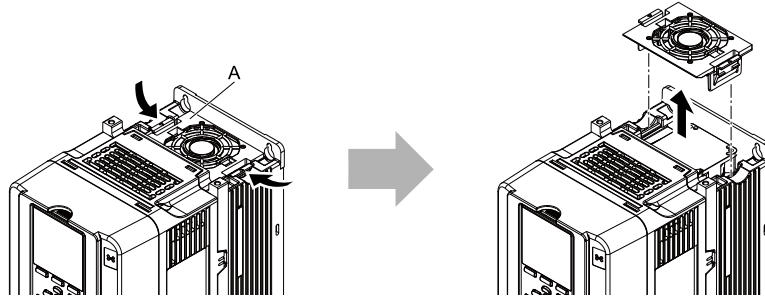

A - Fan finger guard

Figure 8.1 Remove the Fan Finger Guard

2. Pull the cooling fan straight up from the drive. Disconnect the relay connector and remove the fan from the drive.

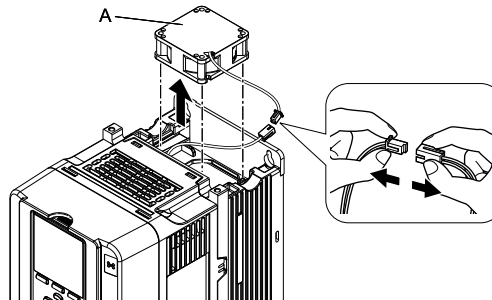

A - Cooling fan

Figure 8.2 Remove the Cooling Fan

■ Fan Installation

Reverse the removal procedure for fan installation.

1. Connect the relay connector between the drive and cooling fan.

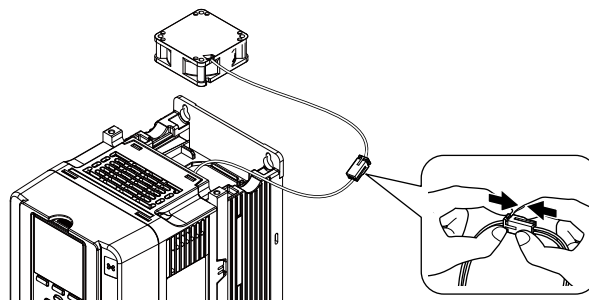
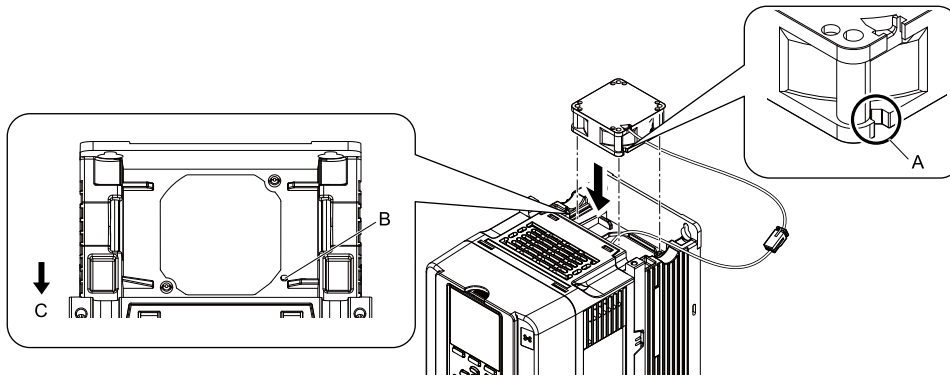

Figure 8.3 Connect the Relay Connector

- Align the notch on the fan with the pin on the drive and install the cooling fan in the drive.



A - Notch on fan
B - Alignment pin on drive

C - Front of drive

Figure 8.4 Install the Cooling Fan

- Put the cable and connector in the recess of the drive.

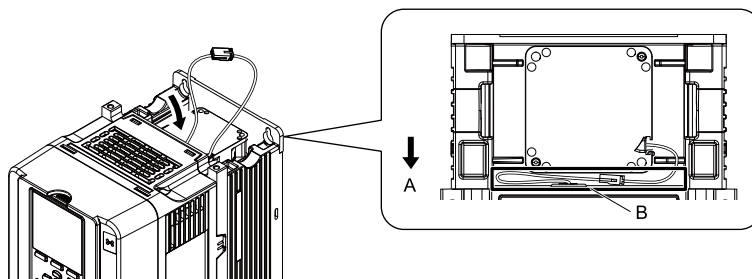

A - Front of drive

B - Space for cable **1*

Figure 8.5 Put the Cable and Connector in the Drive Recess

**1* Make sure that the cable and connector are in the correct space.

- Insert the fan finger guard straight until the hooks click into place.

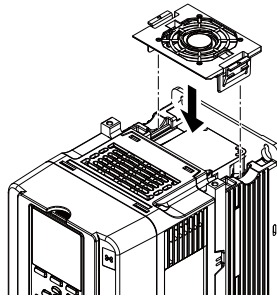

Figure 8.6 Reattach the Fan Finger Guard

- Energize the drive and set o4-03 = 0 [Fan Operation Time Setting = 0 h] to reset the fan operation time.

◆ Fan Replacement (Procedure B)

DANGER! *Electrical Shock Hazard. Do not examine, connect, or disconnect wiring on an energized drive. Before servicing, disconnect all power to the equipment and wait for the time specified on the warning label at a minimum. The internal capacitor stays charged after the drive is de-energized. The charge indicator LED extinguishes when the DC bus voltage decreases below 50 Vdc. When all indicators are OFF, remove the covers before measuring for dangerous voltages to make sure that the drive is safe. If you do work on the drive when it is energized, it will cause serious injury or death from electrical shock.*

CAUTION! *Burn Hazard. Do not touch a hot drive heatsink. De-energize the drive, wait for a minimum of 15 minutes, then make sure that the heatsink is cool before you replace the cooling fans. If you touch a hot drive heatsink, it can burn you.*

NOTICE: *Use the instructions in this manual to replace the cooling fans. When you do maintenance on the fans, replace all the fans to increase product life. If you install the fans incorrectly, it can cause damage to the drive.*

■ Fan Removal

1. To remove the fan finger guard from the drive, push the hook on the back side of the fan finger guard and pull up.

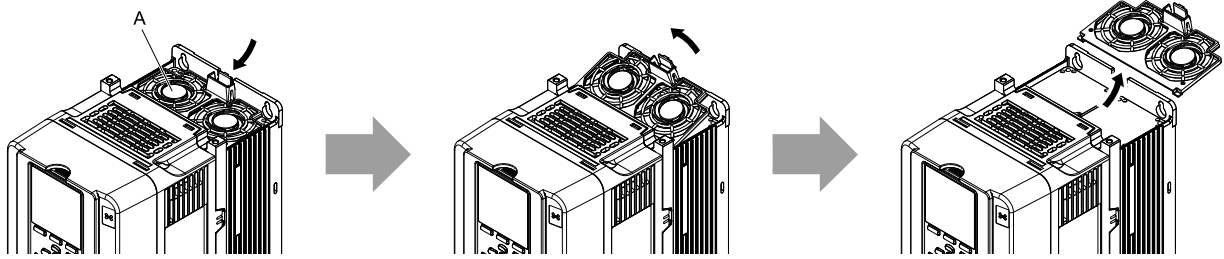

A - Fan finger guard

Figure 8.7 Remove the Fan Finger Guard

2. Pull the cooling fans straight up from the drive. Disconnect the relay connectors and remove the fans from the drive.

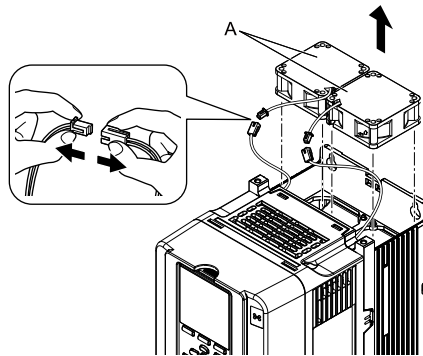

A - Cooling fans

Figure 8.8 Remove the Cooling Fans

■ Fan Installation

Reverse the removal procedure for fan installation.

1. Connect the relay connectors between the drive and cooling fans.

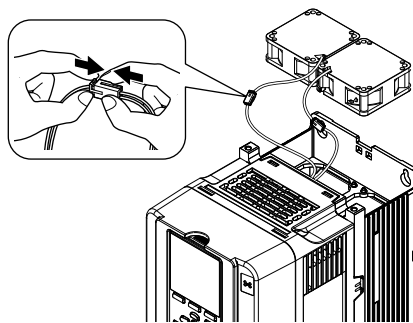
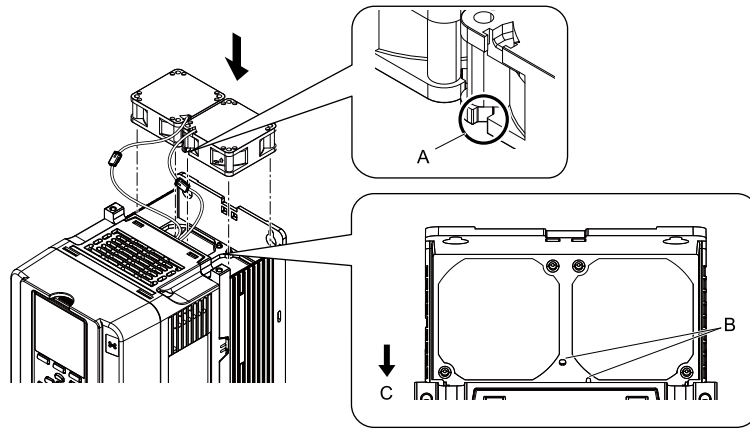

Figure 8.9 Connect the Relay Connectors

- Align the notches on the fans with the pins on the drive and install the cooling fans in the drive.



A - Notch on fan
B - Alignment pins on drive

C - Front of drive

Figure 8.10 Install the Cooling Fans

- Put the cables in the recess of the drive.

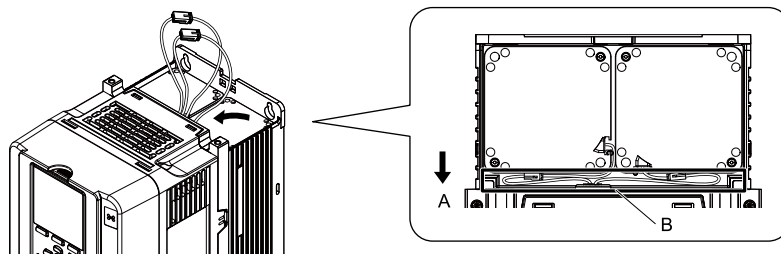

A - Front of drive

B - Space for cables *1

Figure 8.11 Put the Cables and Connectors in the Drive Recess

*1 Make sure that the cables and connectors are in the correct space.

- Hold the fan finger guard at an angle and put the connector tabs on the fan finger guard into the holes on the drive.

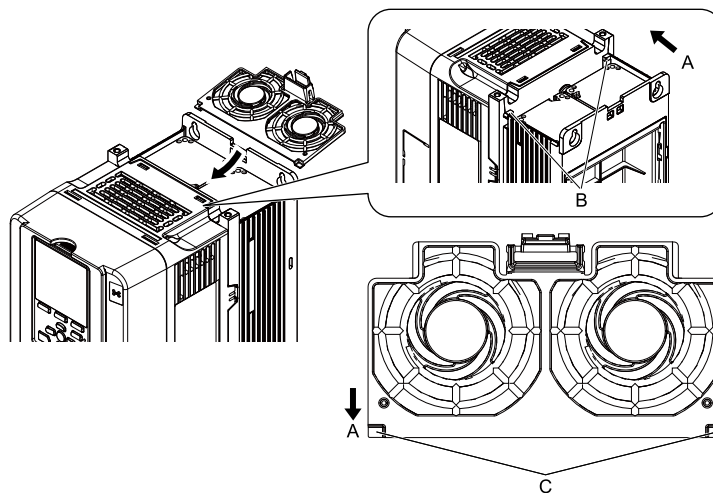

A - Front of drive
B - Drive holes

C - Connector tabs

Figure 8.12 Reattach the Fan Finger Guard

5. Push the hook on the back side of the fan finger guard and click it into place on the drive.

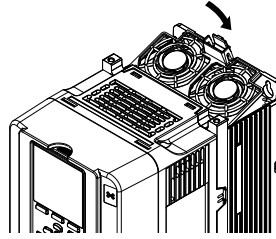

Figure 8.13 Reattach the Fan Finger Guard

6. Energize the drive and set $\alpha 4-03 = 0$ [Fan Operation Time Setting = 0 h] to reset the fan operation time.

◆ Fan Replacement (Procedure C)

DANGER! *Electrical Shock Hazard. Do not examine, connect, or disconnect wiring on an energized drive. Before servicing, disconnect all power to the equipment and wait for the time specified on the warning label at a minimum. The internal capacitor stays charged after the drive is de-energized. The charge indicator LED extinguishes when the DC bus voltage decreases below 50 Vdc. When all indicators are OFF, remove the covers before measuring for dangerous voltages to make sure that the drive is safe. If you do work on the drive when it is energized, it will cause serious injury or death from electrical shock.*

CAUTION! *Burn Hazard. Do not touch a hot drive heatsink. De-energize the drive, wait for a minimum of 15 minutes, then make sure that the heatsink is cool before you replace the cooling fans. If you touch a hot drive heatsink, it can burn you.*

NOTICE: *Use the instructions in this manual to replace the cooling fans. When you do maintenance on the fans, replace all the fans to increase product life. If you install the fans incorrectly, it can cause damage to the drive.*

■ Fan Removal

1. To remove the fan finger guard from the drive, push the hooks on the left and right sides of it and pull up.

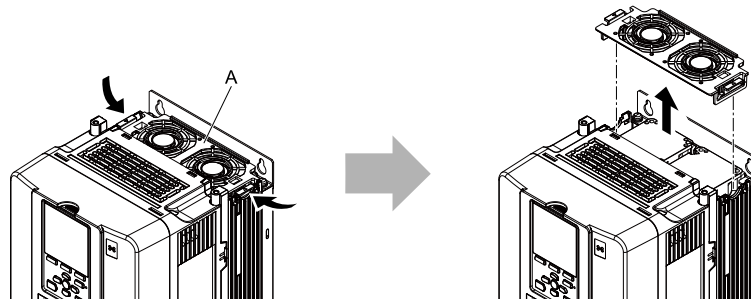

A - Fan finger guard

Figure 8.14 Remove the Fan Finger Guard

2. Pull the cooling fans straight up from the drive. Disconnect the relay connectors and remove the fans from the drive.

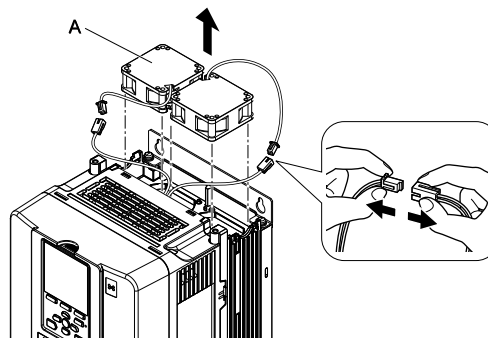

A - Cooling fans

Figure 8.15 Remove the Cooling Fans

■ Fan Installation

Reverse the removal procedure for fan installation.

8.4 Replace Cooling Fans and Circulation Fans

1. Connect the relay connectors between the drive and cooling fans.

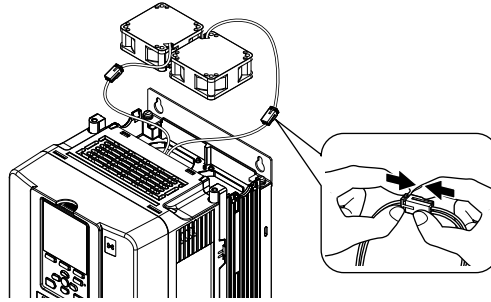
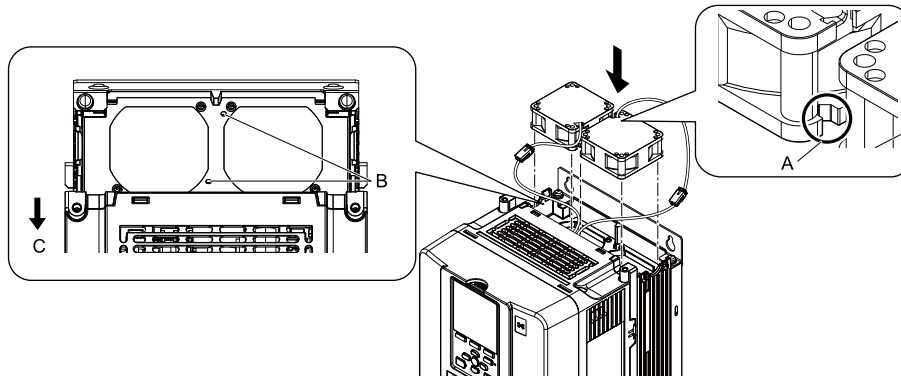

Figure 8.16 Connect the Relay Connectors

2. Align the notches on the fans with the pins on the drive and install the cooling fans in the drive.



A - Notch on fan

B - Alignment pins on drive

C - Front of drive

Figure 8.17 Install the Cooling Fans

3. Put the cables and connectors in the recess of the drive.

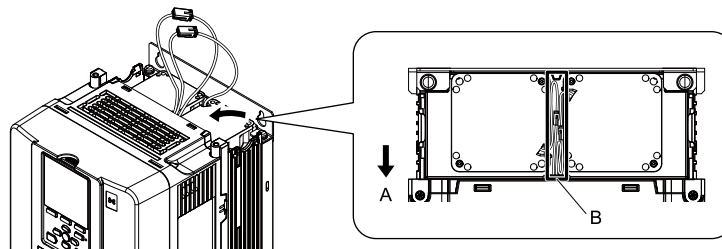

A - Front of drive

B - Space for cables ^{*1}

Figure 8.18 Put the Cables and Connectors in the Drive Recess

*1 Make sure that the cables and connectors are in the correct space.

4. Insert the fan finger guard straight until the hooks click into place.

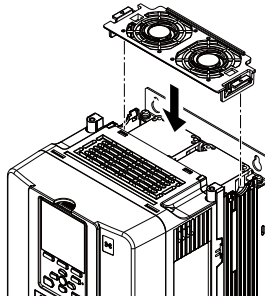

Figure 8.19 Reattach the Fan Finger Guard

5. Energize the drive and set o4-03 = 0 [Fan Operation Time Setting = 0 h] to reset the fan operation time.

◆ Fan Replacement (Procedure D)

DANGER! Electrical Shock Hazard. Do not examine, connect, or disconnect wiring on an energized drive. Before servicing, disconnect all power to the equipment and wait for the time specified on the warning label at a minimum. The internal capacitor stays charged after the drive is de-energized. The charge indicator LED extinguishes when the DC bus voltage decreases below 50 Vdc. When all indicators are OFF, remove the covers before measuring for dangerous voltages to make sure that the drive is safe. If you do work on the drive when it is energized, it will cause serious injury or death from electrical shock.

CAUTION! Burn Hazard. Do not touch a hot drive heatsink. De-energize the drive, wait for a minimum of 15 minutes, then make sure that the heatsink is cool before you replace the cooling fans. If you touch a hot drive heatsink, it can burn you.

NOTICE: Use the instructions in this manual to replace the cooling fans. When you do maintenance on the fans, replace all the fans to increase product life. If you install the fans incorrectly, it can cause damage to the drive.

■ Fan Removal

1. To remove the fan finger guard from the drive, push the hooks on the left and right sides of it and pull up.

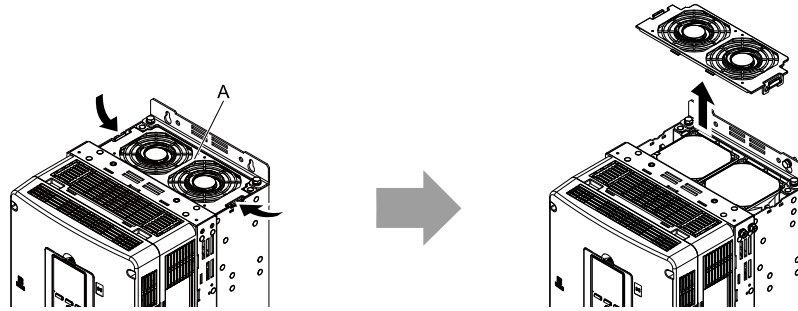

A - Fan finger guard

Figure 8.20 Remove the Fan Finger Guard

2. Pull the cooling fans straight up from the drive. Disconnect the relay connectors and remove the fans from the drive.

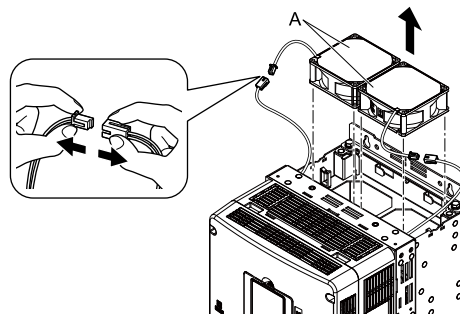

A - Cooling fans

Figure 8.21 Remove the Cooling Fans

■ Fan Installation

Reverse the removal procedure for fan installation.

1. Connect the relay connectors between the drive and cooling fans.

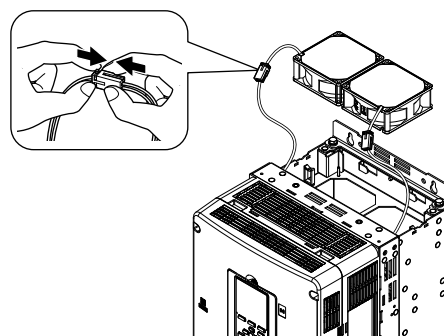
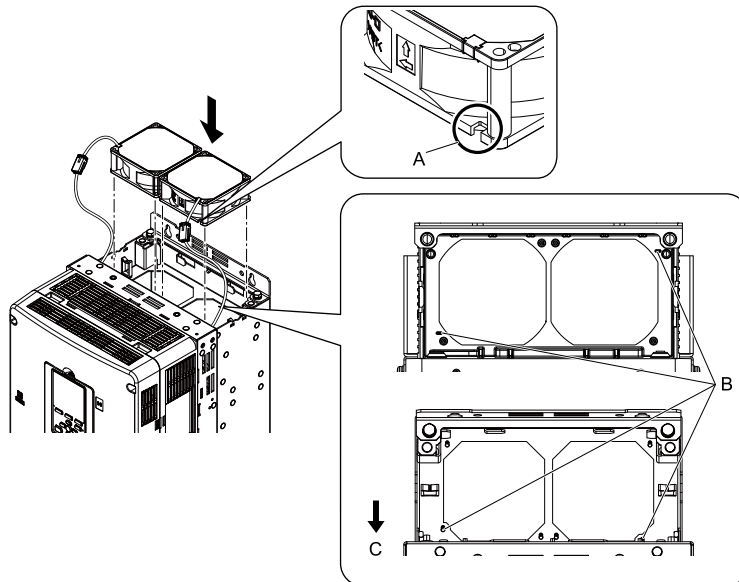

Figure 8.22 Connect the Relay Connectors

- Align the notches on the fans with the pins on the drive and install the cooling fans in the drive.



A - Notch on fan

B - Alignment pins on drive

C - Front of drive

Figure 8.23 Install the Cooling Fans

- Put the cables and connectors in the recess of the drive.

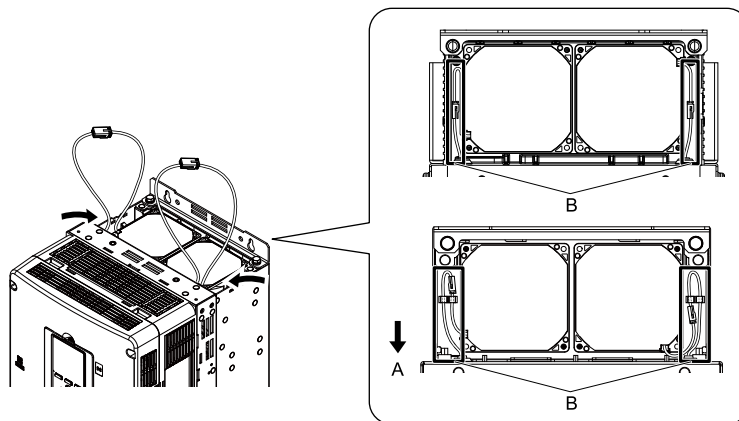

A - Front of drive

B - Space for cables ^{*1}

Figure 8.24 Put the Cables and Connectors in the Drive Recess

*1 Make sure that the cables and connectors are in the correct space.

- Push the hooks on the left and right sides of the fan finger guard and click it into place on the drive.

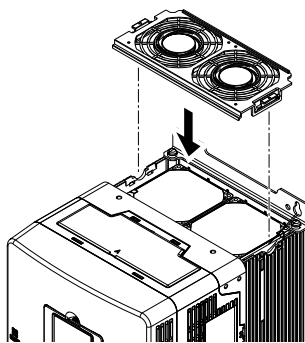

Figure 8.25 Reattach the Fan Finger Guard

- Energize the drive and set $o4-03 = 0$ [Fan Operation Time Setting = 0 h] to reset the fan operation time.

◆ Fan Replacement (Procedure E)

DANGER! Electrical Shock Hazard. Do not examine, connect, or disconnect wiring on an energized drive. Before servicing, disconnect all power to the equipment and wait for the time specified on the warning label at a minimum. The internal capacitor stays charged after the drive is de-energized. The charge indicator LED extinguishes when the DC bus voltage decreases below 50 Vdc. When all indicators are OFF, remove the covers before measuring for dangerous voltages to make sure that the drive is safe. If you do work on the drive when it is energized, it will cause serious injury or death from electrical shock.

CAUTION! Burn Hazard. Do not touch a hot drive heatsink. De-energize the drive, wait for a minimum of 15 minutes, then make sure that the heatsink is cool before you replace the cooling fans. If you touch a hot drive heatsink, it can burn you.

NOTICE: Use the instructions in this manual to replace the cooling fans. When you do maintenance on the fans, replace all the fans to increase product life. If you install the fans incorrectly, it can cause damage to the drive.

■ Fan Removal

1. To remove the fan finger guard from the drive, push the tabs on the left and right sides of it and pull up the back side of the guard.

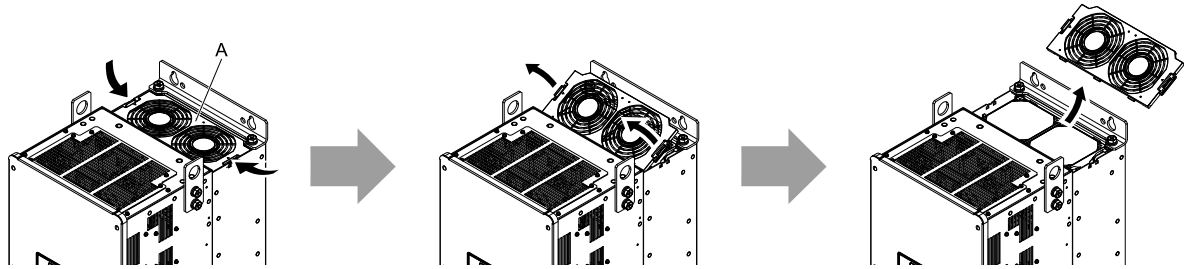

A - Fan finger guard

Figure 8.26 Remove the Fan Finger Guard

2. Pull the cooling fans straight up from the drive. Disconnect the relay connectors and remove the fans from the drive.

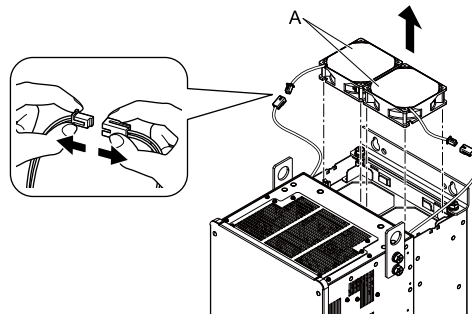

A - Cooling fans

Figure 8.27 Remove the Cooling Fans

■ Fan Installation

Reverse the removal procedure for fan installation.

1. Connect the relay connectors between the drive and cooling fans.

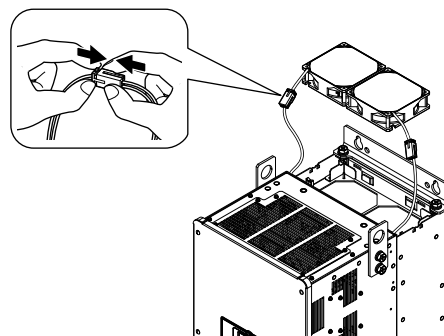
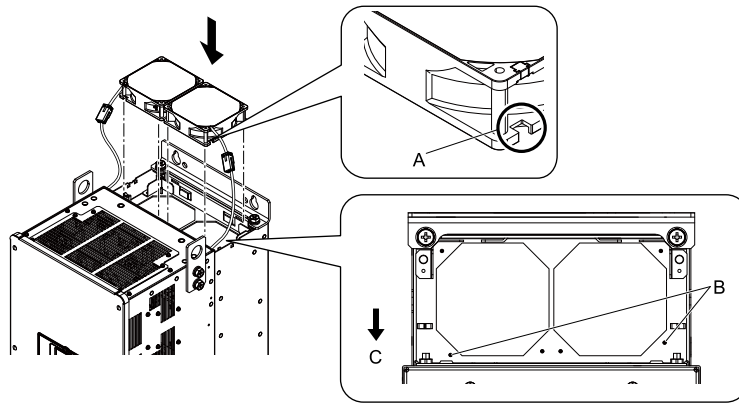

Figure 8.28 Connect the Relay Connectors

- Align the notches on the fans with the pins on the drive and install the cooling fans in the drive.



A - Notch on fan
B - Alignment pins on drive

C - Front of drive

Figure 8.29 Install the Cooling Fans

- Put the cables and connectors in the recess of the drive.

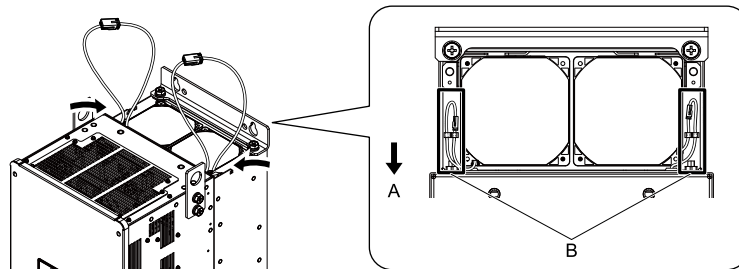

A - Front of drive

B - Space for cables *1

Figure 8.30 Put the Cables and Connectors in the Drive Recess

*1 Make sure that the cables and connectors are in the correct space.

- Hold the fan finger guard at an angle and put the connector tabs on the fan finger guard into the holes on the drive.

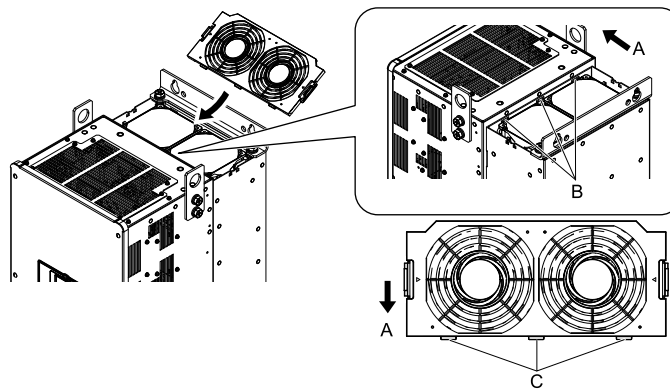

A - Front of drive
B - Drive holes

C - Connector tabs

Figure 8.31 Reattach the Fan Finger Guard

5. Push the hooks on the left and right sides of the fan finger guard and click it into place on the drive.

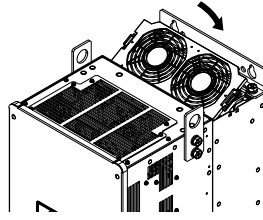

Figure 8.32 Reattach the Fan Finger Guard

6. Energize the drive and set o4-03 = 0 [Fan Operation Time Setting = 0 h] to reset the fan operation time.

◆ Fan Replacement (Procedure F)

DANGER! Electrical Shock Hazard. Do not examine, connect, or disconnect wiring on an energized drive. Before servicing, disconnect all power to the equipment and wait for the time specified on the warning label at a minimum. The internal capacitor stays charged after the drive is de-energized. The charge indicator LED extinguishes when the DC bus voltage decreases below 50 Vdc. When all indicators are OFF, remove the covers before measuring for dangerous voltages to make sure that the drive is safe. If you do work on the drive when it is energized, it will cause serious injury or death from electrical shock.

CAUTION! Burn Hazard. Do not touch a hot drive heatsink. De-energize the drive, wait for a minimum of 15 minutes, then make sure that the heatsink is cool before you replace the cooling fans. If you touch a hot drive heatsink, it can burn you.

NOTICE: Use the instructions in this manual to replace the cooling fans. When you do maintenance on the fans, replace all the fans to increase product life. If you install the fans incorrectly, it can cause damage to the drive.

■ Fan Removal

1. To remove the fan finger guards from the drive, push the hook on the back side of each guard and pull up.

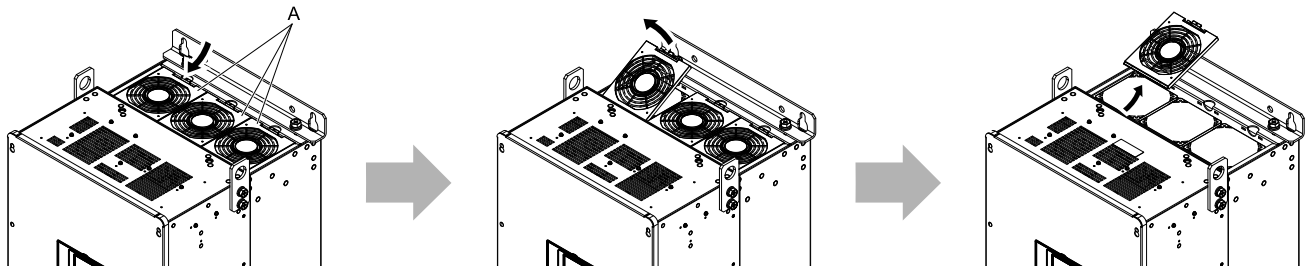

A - Fan finger guards

Figure 8.33 Remove the Fan Finger Guards

2. Pull the cooling fans straight up from the drive. Disconnect the relay connectors and remove the fans from the drive.

Note:

The number of fans is different for different drive models.

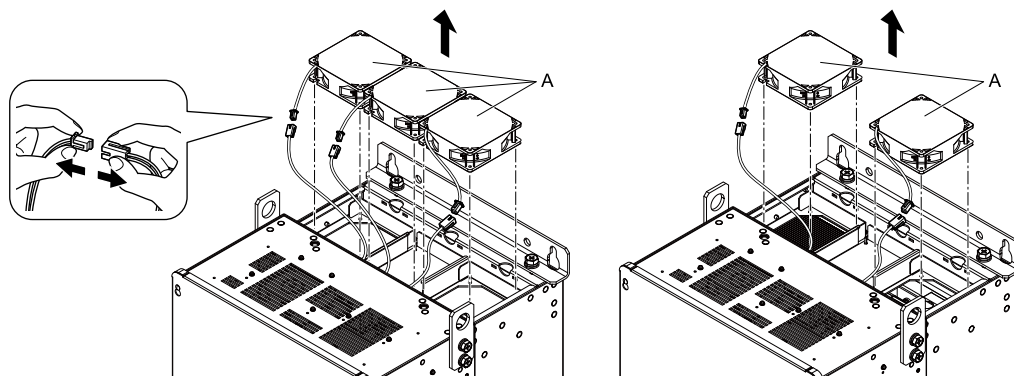

A - Cooling fans

Figure 8.34 Remove the Cooling Fans

■ Fan Installation

Reverse the removal procedure for fan installation.

1. Connect the relay connectors between the drive and cooling fans.

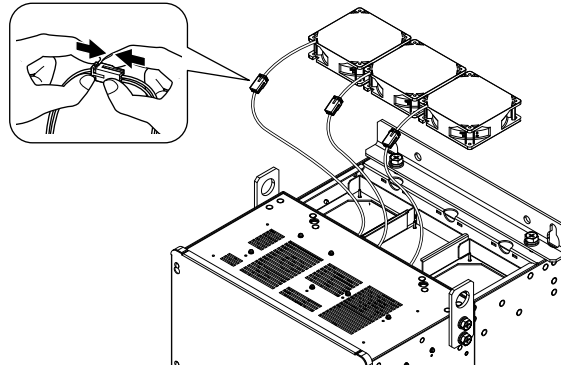
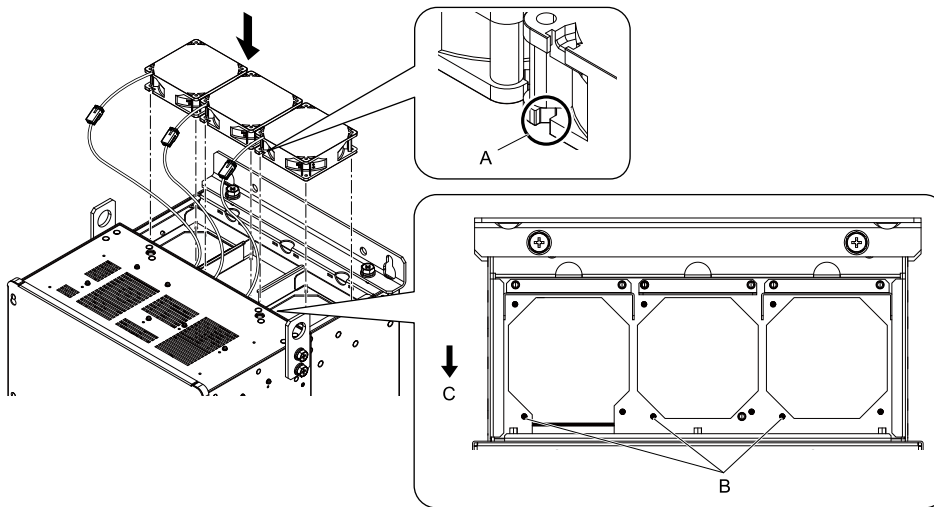

Figure 8.35 Connect the Relay Connectors

2. Align the notches on the fans with the pins on the drive and install the cooling fans in the drive.



A - Notch on fan

B - Alignment pins on drive

C - Front of drive

Figure 8.36 Install the Cooling Fans

3. Put the cables and connectors in the recess of the drive.

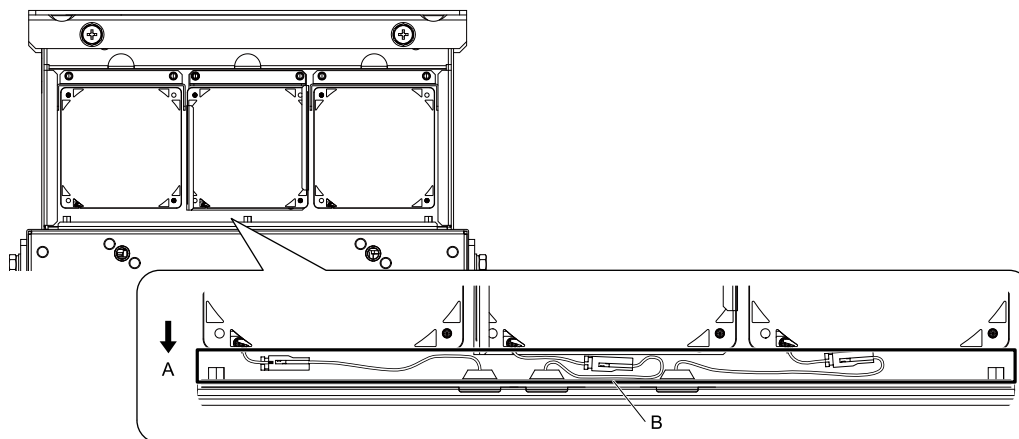

A - Front of drive

B - Space for cables ^{*1}

Figure 8.37 Put the Cables and Connectors in the Drive Recess

^{*1} Make sure that the cables and connectors are in the correct space.

4. Hold the fan finger guards at an angle and put the connector tabs on the fan finger guards into the holes on the drive.

Note:

When you install the cooling fans, make sure that you do not pinch cables between the fan finger guards and the drive.

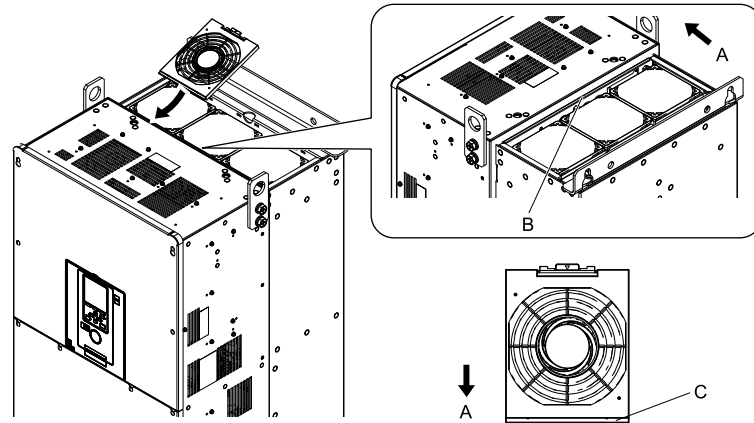

A - Front of drive
B - Insertion area

C - Connector tab

Figure 8.38 Reattach the Fan Finger Guards

5. Push the hooks on the back side of the fan finger guards and click them into place on the drive.

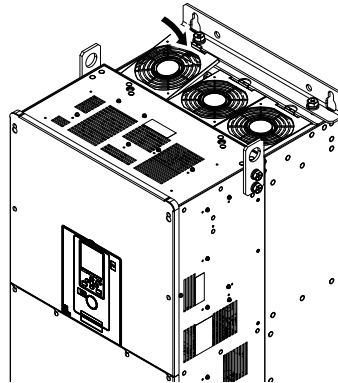

Figure 8.39 Reattach the Fan Finger Guards

6. Energize the drive and set $o4-03 = 0$ [Fan Operation Time Setting = 0 h] to reset the fan operation time.

■ Circulation Fan Removal

Remove the drive cover before you start this procedure.

CAUTION! *Crush Hazard. Loosen the cover screws. Do not fully remove them. If you fully remove the cover screws, the terminal cover can fall and cause moderate injury.*

8.4 Replace Cooling Fans and Circulation Fans

1. Remove the cable from the clamps.

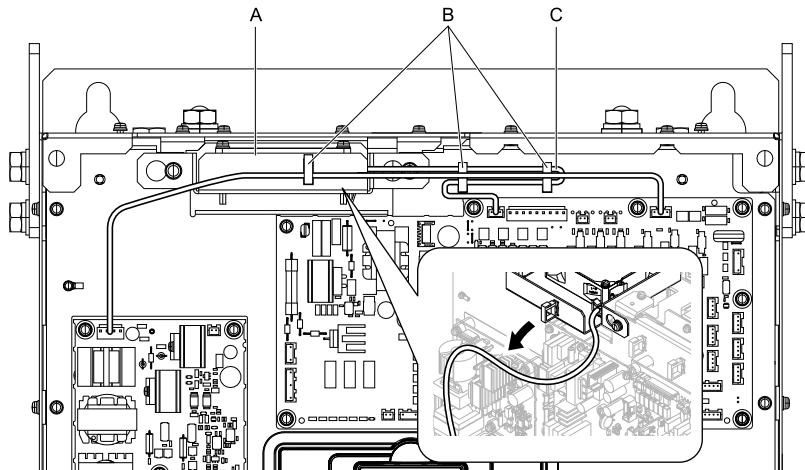

A - Fan unit
B - Clamps

C - Fan cable

Figure 8.40 Remove the Fan Cable

2. Loosen the screws that safety the fan unit and slide the fan unit to the right.

Note:

To remove the fan unit, it is only necessary to loosen the screws.

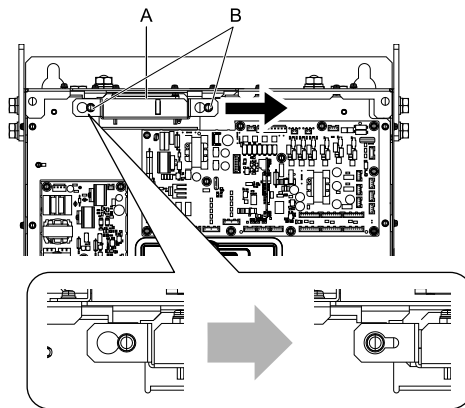

A - Fan unit

B - Screws

Figure 8.41 Slide the Fan Unit

3. Disconnect the relay connector and remove the fan unit.

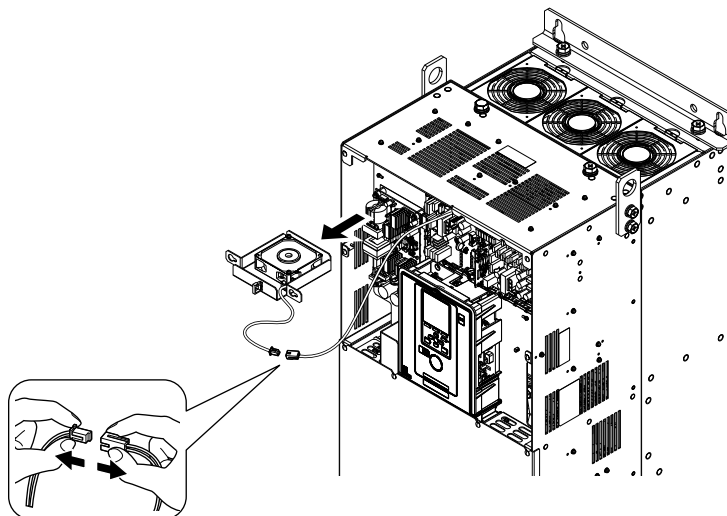
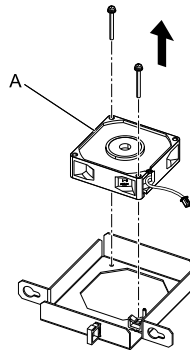

Figure 8.42 Remove the Fan Unit

- Remove the screws that safety the circulation fan and remove the fan.



A - Circulation fan

Figure 8.43 Remove the Circulation Fan

■ Circulation Fan Installation

Reverse the removal procedure for fan installation.

- Connect the relay connector between the drive and circulation fan.

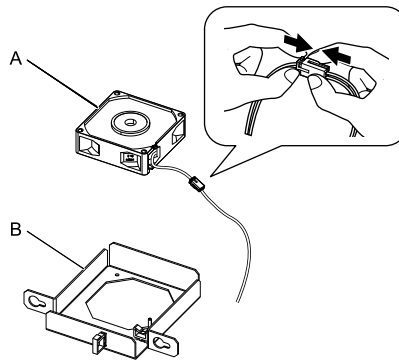

A - Circulation fan

B - Fan unit base

Figure 8.44 Connect the Relay Connector

- Align the pin on the fan unit base with the notch on the fan and put the fan in the fan unit base, then use the screws to safety it.

Tighten the screws to a correct tightening torque:

- 0.98 N·m to 1.33 N·m (8.67 lbf·in to 11.77 lbf·in)

A - Circulation fan
B - Fan unit baseC - Alignment pin on fan unit base
D - Circulation fan connector

Figure 8.45 Install the Circulation Fan

3. Safety the fan cable through the clamp.

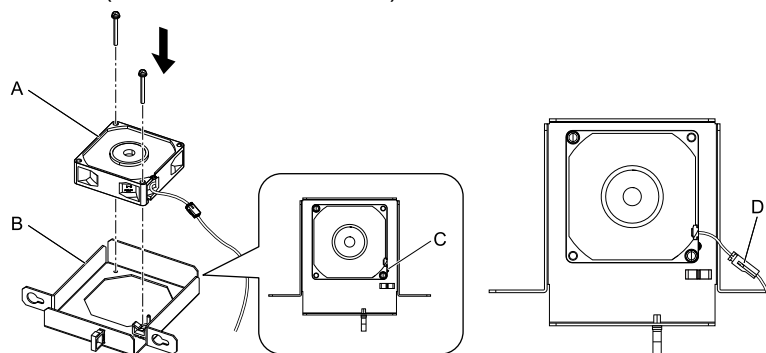
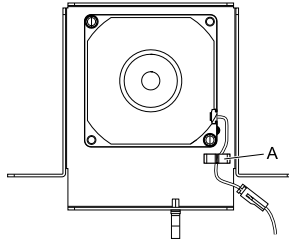

A - Clamp

Figure 8.46 Safety the Fan Cable

4. Put the fan unit into the specified location and slide it to the left, then use screws to safety it to the drive.
Tighten the screws to a correct tightening torque:
 - 0.98 N·m to 1.33 N·m (8.67 lbf·in to 11.77 lbf·in)

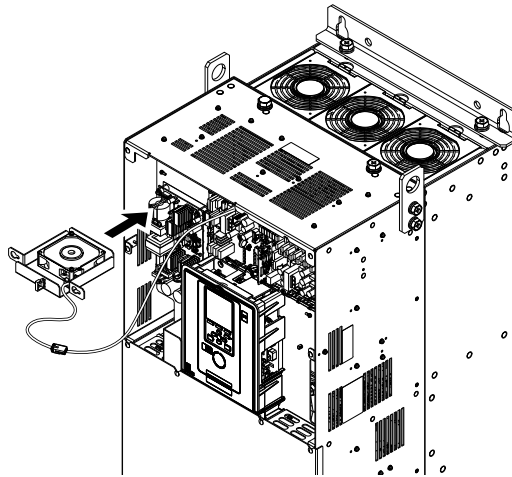
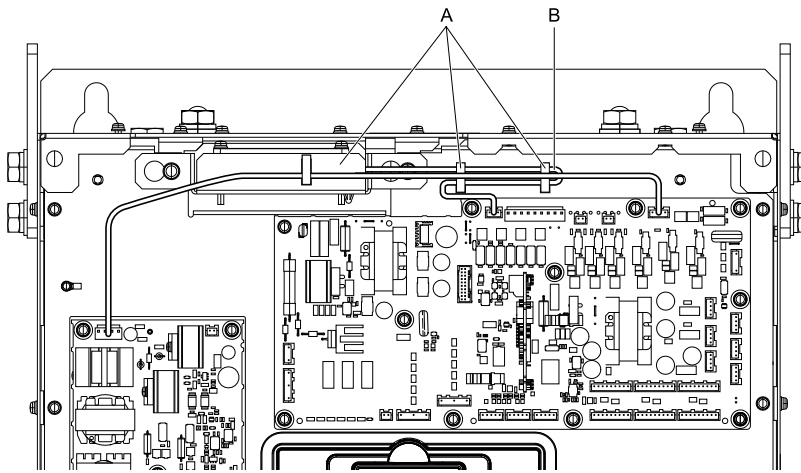

Figure 8.47 Install the Fan Unit

5. Safety the cable through the clamps.



A - Clamps

B - Fan cable

Figure 8.48 Safety the Fan Cable through the Clamps

6. Install the drive cover.
7. Energize the drive and set $o4-03 = 0$ [Fan Operation Time Setting = 0 h] to reset the fan operation time.

◆ Fan Replacement (Procedure G)

DANGER! Electrical Shock Hazard. Do not examine, connect, or disconnect wiring on an energized drive. Before servicing, disconnect all power to the equipment and wait for the time specified on the warning label at a minimum. The internal capacitor stays charged after the drive is de-energized. The charge indicator LED extinguishes when the DC bus voltage decreases below 50 Vdc. When all indicators are OFF, remove the covers before measuring for dangerous voltages to make sure that the drive is safe. If you do work on the drive when it is energized, it will cause serious injury or death from electrical shock.

CAUTION! Burn Hazard. Do not touch a hot drive heatsink. De-energize the drive, wait for a minimum of 15 minutes, then make sure that the heatsink is cool before you replace the cooling fans. If you touch a hot drive heatsink, it can burn you.

NOTICE: Use the instructions in this manual to replace the cooling fans. When you do maintenance on the fans, replace all the fans to increase product life. If you install the fans incorrectly, it can cause damage to the drive.

■ Fan Removal

1. Remove the drive cover.

CAUTION! Crush Hazard. Loosen the cover screws. Do not fully remove them. If you fully remove the cover screws, the terminal cover can fall and cause moderate injury.

2. Unplug the fan cable from the fan connectors.

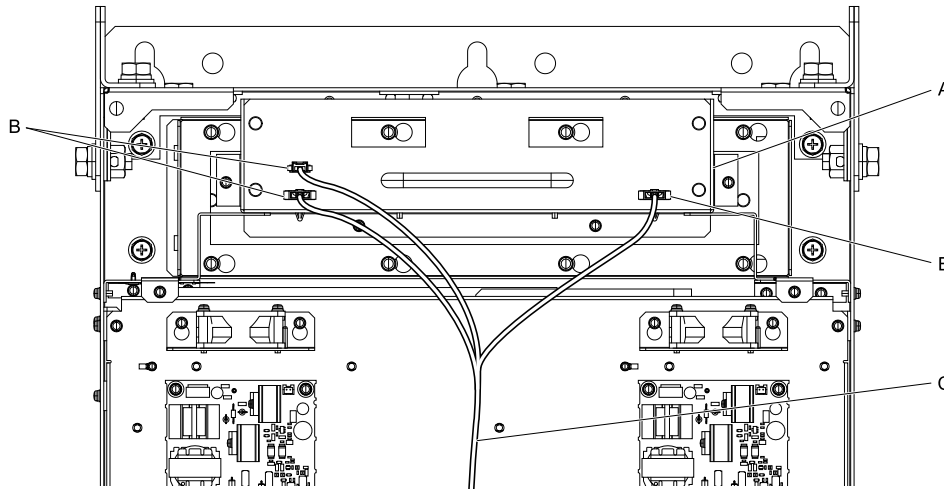

A - Fan unit
B - Fan connectors

C - Fan cable

Figure 8.49 Remove the Fan Cable

3. Loosen the screws that safety the fan unit and slide the slide panel to the left.

Note:

To remove the fan unit, it is only necessary to loosen the screws in position B.

Remove the screws in position A.

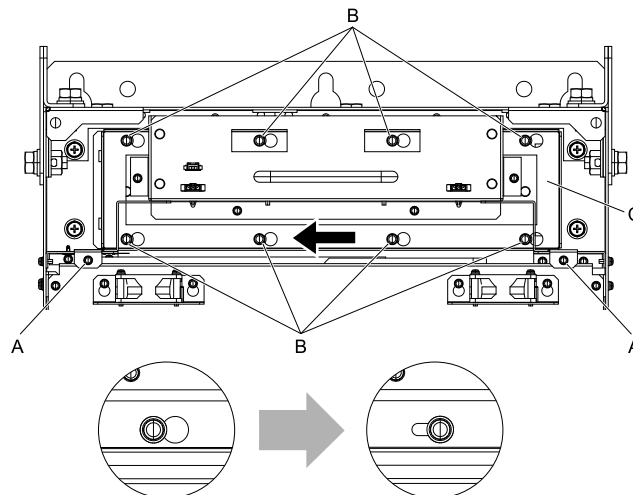

A - Screw position A
B - Screw position B

C - Slide panel

Figure 8.50 Slide the Slide Panel

4. Remove the fan unit and the slide panel at the same time.

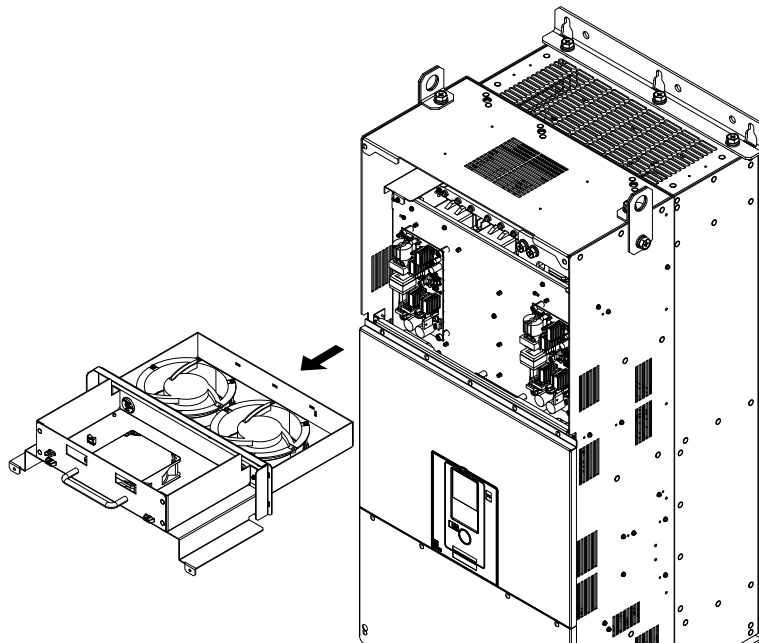
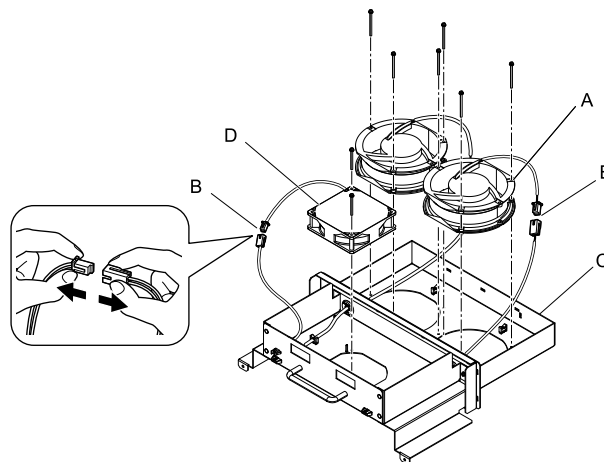

Figure 8.51 Remove the Fan Unit

5. Unplug the relay connectors, remove the screws that safety the cooling fans and circulation fan, and then remove the fans.



A - Cooling fans

B - Relay connectors

C - Fan unit base

D - Circulation fan

Figure 8.52 Remove the Cooling Fans and Circulation Fan

■ Fan Installation

Reverse the removal procedure for fan installation.

1. Connect the relay connectors on the fan unit base to the cooling fans and the circulation fan.

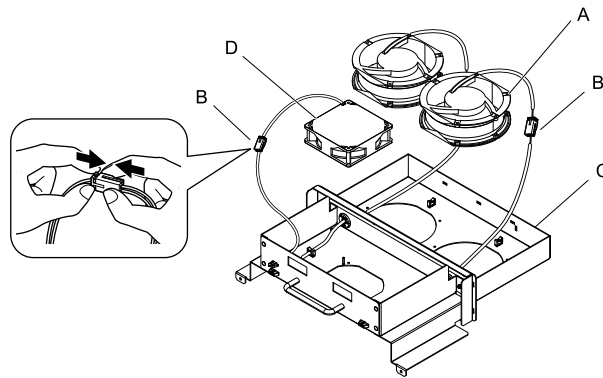

A - Cooling fans
B - Relay connectors

C - Fan unit base
D - Circulation fan

Figure 8.53 Connect the Relay Connectors

2. Align the pins on the fan unit base with the notches on the fans and put the fans in the fan unit base, then use the screws to safety them.

Tighten the screws to a correct tightening torque:

- 0.98 N·m to 1.33 N·m (8.67 lbf·in to 11.77 lbf·in)

Note:

Make sure that you do not pinch cables between the fans and the fan unit base.

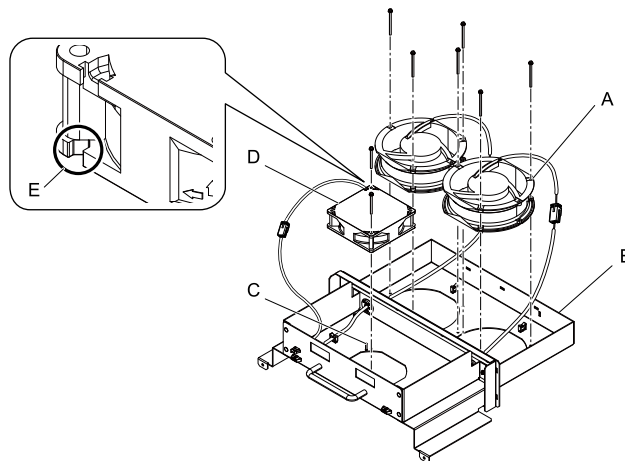

A - Cooling fans
B - Fan unit base
C - Alignment pin on fan unit base

D - Circulation fan
E - Notch on fan

Figure 8.54 Install the Cooling Fans and Circulation Fan

3. Put the cables and connectors in the recess of the drive.

Note:

Safety the relay cables to the hooks.

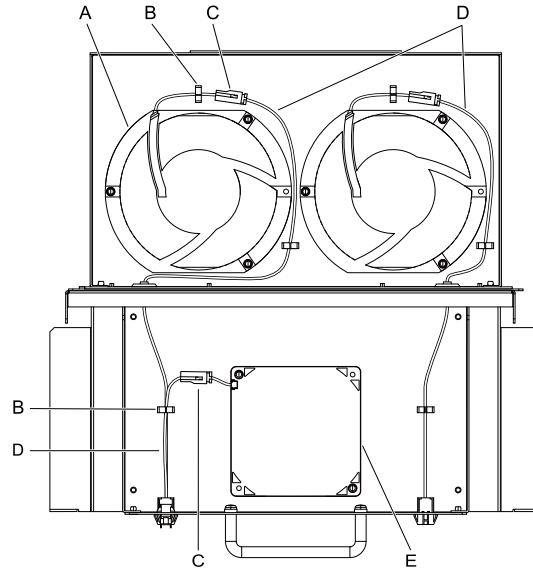

A - Cooling fans
B - Cable hooks
C - Relay connectors

D - Relay cables
E - Circulation fan

Figure 8.55 Put the Cables and Connectors in the Drive Recess

- Put the fan unit into the specified location.

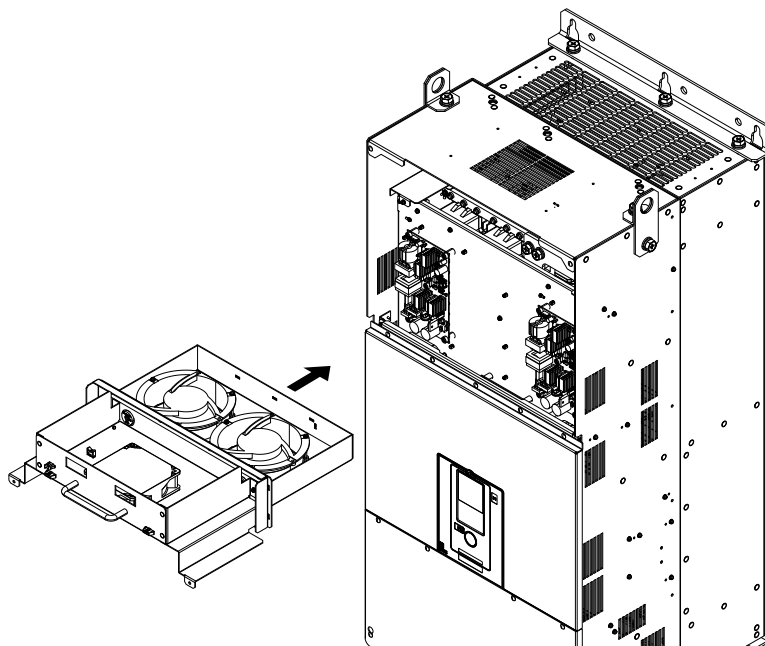
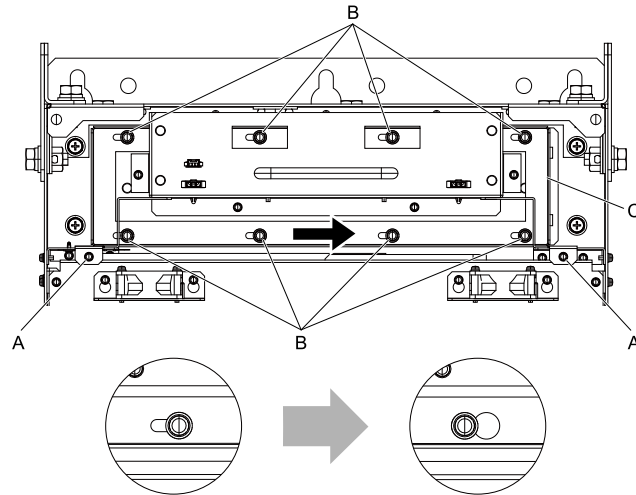

Figure 8.56 Install the Fan Unit

- Slide the fan unit to the right and use the screws to safety it to the drive.
Tighten the screws to a correct tightening torque:
 - Screws in Position A: 0.98 N·m to 1.33 N·m (8.67 lbf·in to 11.77 lbf·in)
 - Screws in Position B: 1.96 N·m to 2.53 N·m (17.35 lbf·in to 22.39 lbf·in)



A - Screw position A
B - Screw position B

C - Fan unit

Figure 8.57 Slide the Fan Unit

6. Connect the fan cable to the fan connectors.

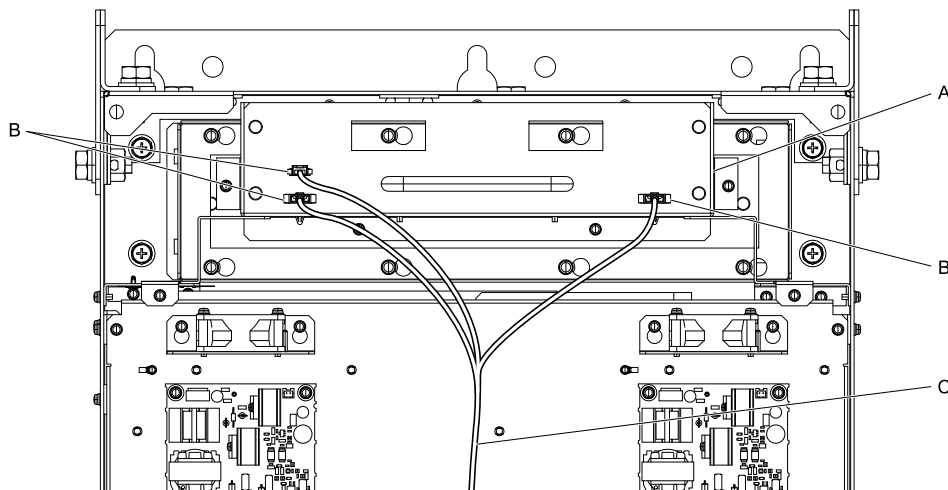

A - Fan unit
B - Fan connectors

C - Fan cable

Figure 8.58 Connect Cooling Fan Connectors

7. Install the drive cover.
8. Energize the drive and set $o4-03 = 0$ [Fan Operation Time Setting = 0 h] to reset the fan operation time.

■ Circuit Board Cooling Fan Removal

Remove the drive cover before you start this procedure.

CAUTION! *Crush Hazard. Loosen the cover screws. Do not fully remove them. If you fully remove the cover screws, the terminal cover can fall and cause moderate injury.*

8.4 Replace Cooling Fans and Circulation Fans

1. Unplug the fan cables from the fan connectors.

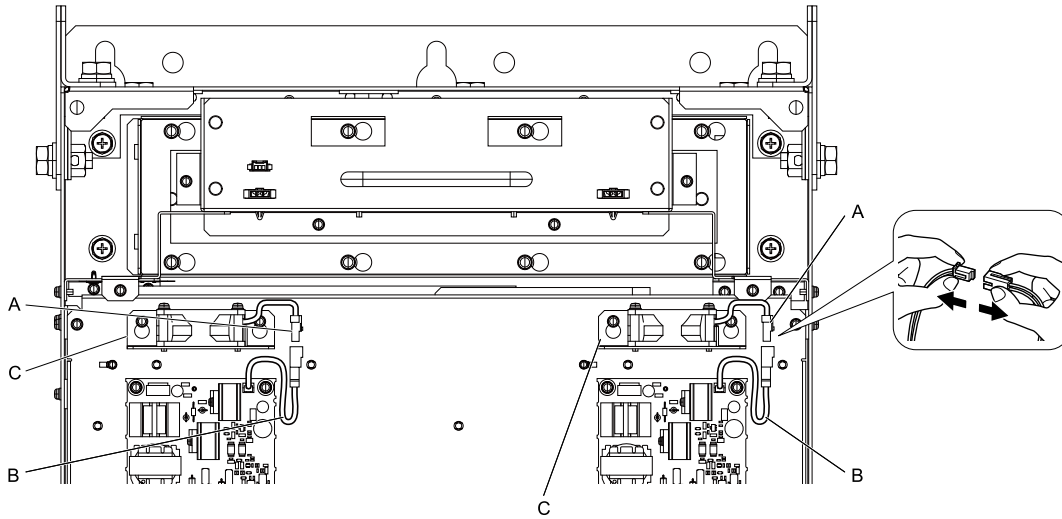

A - Fan connectors
B - Fan cables

C - Circuit board cooling fan units

Figure 8.59 Unplug the Fan Cables

2. Loosen the screws that safety the circuit board cooling fan unit and slide the circuit board cooling fan unit up.

Note:

To remove the fan unit, it is only necessary to loosen the screws.

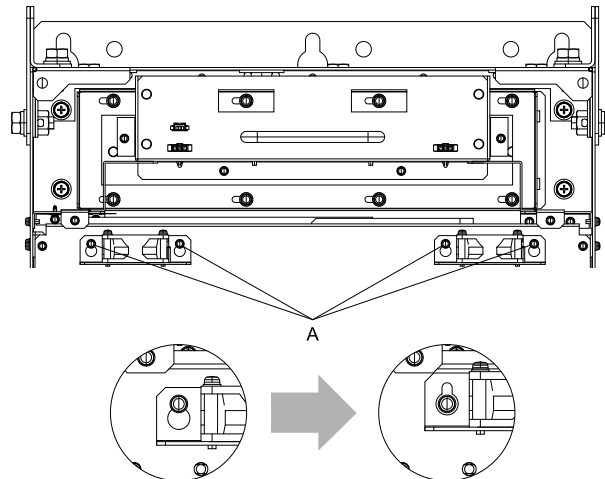

A - Screws

Figure 8.60 Slide the Circuit Board Cooling Fan Units

3. Remove the circuit board cooling fan units.

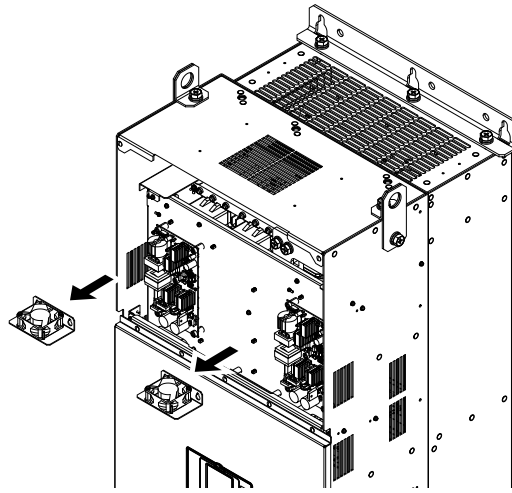
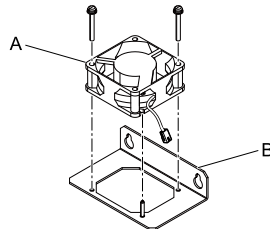

Figure 8.61 Remove the Circuit Board Cooling Fan Units

4. Remove the screws that safety the circuit board cooling fans and remove the fans.



A - Circuit board cooling fan

B - Fan unit base

Figure 8.62 Remove the Circuit Board Cooling Fans

■ Circuit Board Cooling Fan Installation

Reverse the removal procedure for fan installation.

1. Align the pin on the fan unit base with the notch on the fan and put the circuit board cooling fan in the fan unit, then use the screws to safety the circuit board cooling fan to the fan unit base.
Tighten the screws to a correct tightening torque:
 - 0.98 N·m to 1.33 N·m (8.67 lbf·in to 11.77 lbf·in)

Note:

Make sure that you do not pinch cables between the circuit board cooling fan and the fan unit base.

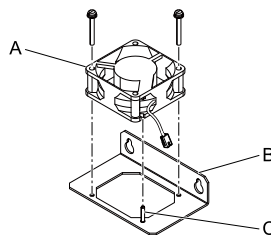

A - Circuit board cooling fan

B - Fan unit base

C - Alignment pin on fan unit base

Figure 8.63 Install the Circuit Board Cooling Fan

2. Put the circuit board cooling fan unit into the specified location and slide it down, then use the screws to safety it to the drive.
Tighten the screws to a correct tightening torque:
 - 0.98 N·m to 1.33 N·m (8.67 lbf·in to 11.77 lbf·in)

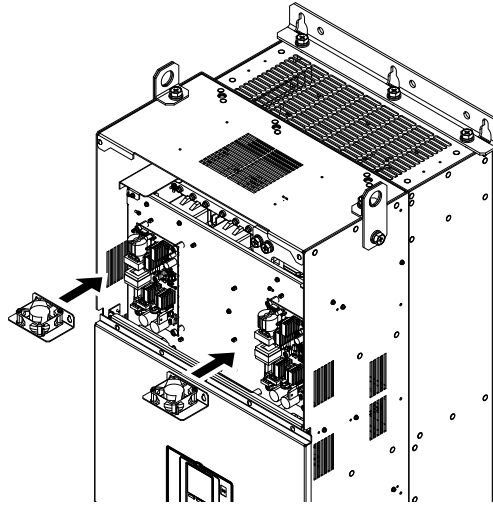
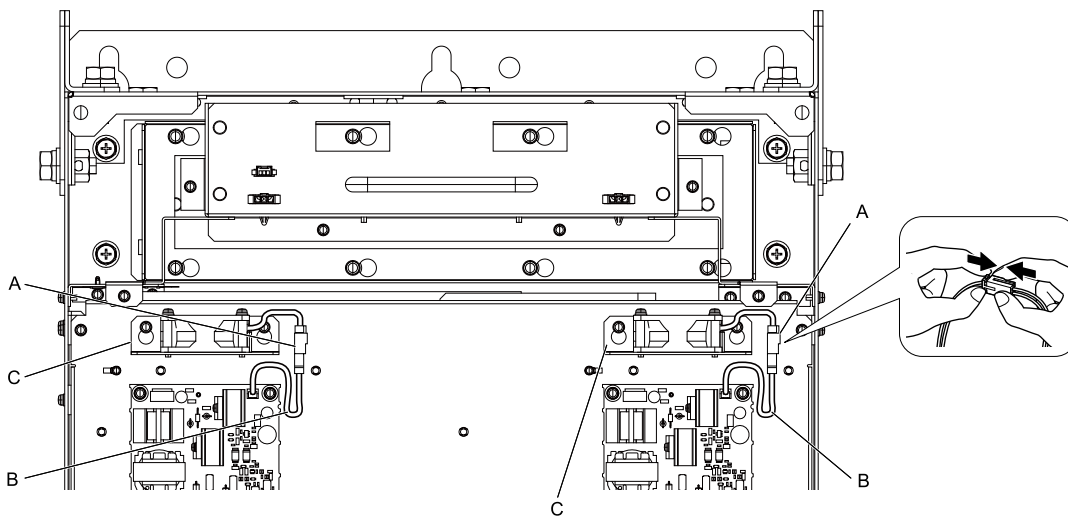

Figure 8.64 Install the Circuit Board Cooling Fan Unit

3. Connect the fan cable to the fan connectors.



A - Fan connectors
B - Fan cable

C - Circuit board cooling fan units

Figure 8.65 Fan Connect Cooling Fan Connectors

4. Install the drive cover.
5. Energize the drive and set $\alpha 4-03 = 0$ [Fan Operation Time Setting = 0 h] to reset the fan operation time.

◆ Fan Replacement (Procedure H)

DANGER! Electrical Shock Hazard. Do not examine, connect, or disconnect wiring on an energized drive. Before servicing, disconnect all power to the equipment and wait for the time specified on the warning label at a minimum. The internal capacitor stays charged after the drive is de-energized. The charge indicator LED extinguishes when the DC bus voltage decreases below 50 Vdc. When all indicators are OFF, remove the covers before measuring for dangerous voltages to make sure that the drive is safe. If you do work on the drive when it is energized, it will cause serious injury or death from electrical shock.

CAUTION! Burn Hazard. Do not touch a hot drive heatsink. De-energize the drive, wait for a minimum of 15 minutes, then make sure that the heatsink is cool before you replace the cooling fans. If you touch a hot drive heatsink, it can burn you.

NOTICE: Use the instructions in this manual to replace the cooling fans. When you do maintenance on the fans, replace all the fans to increase product life. If you install the fans incorrectly, it can cause damage to the drive.

■ Fan Removal

1. Remove the drive cover.

CAUTION! Crush Hazard. Loosen the cover screws. Do not fully remove them. If you fully remove the cover screws, the terminal cover can fall and cause moderate injury.

2. Unplug the fan cables from the fan connectors.

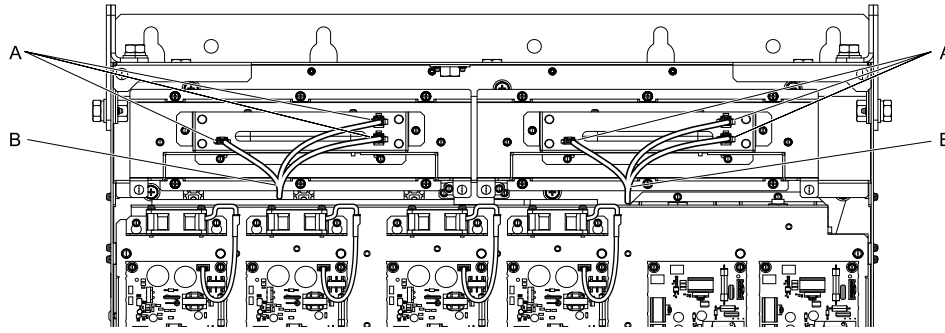

A - Fan connectors

B - Fan cables

Figure 8.66 Components

3. Loosen the screws that safety the fan unit.

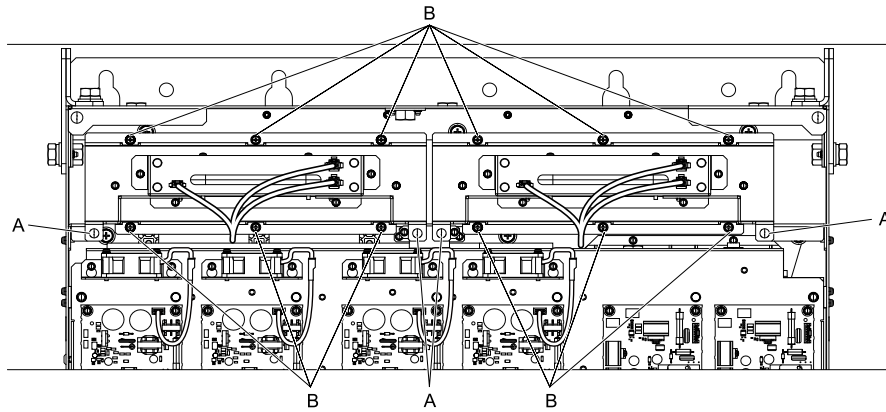

A - Screw position A

B - Screw position B

Figure 8.67 Loosen the Screws

4. Remove the fan unit.

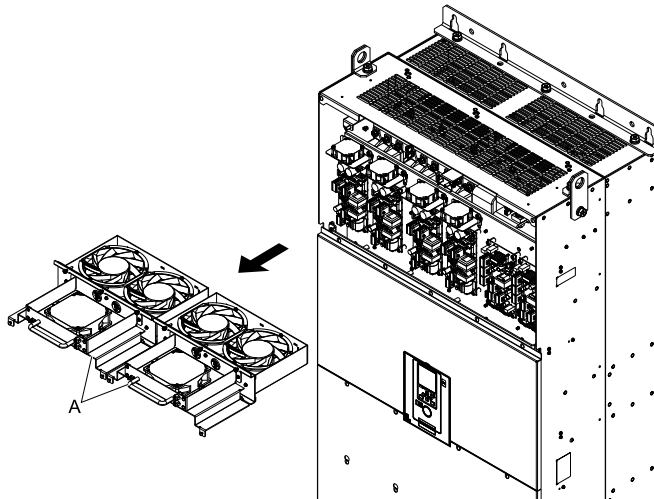
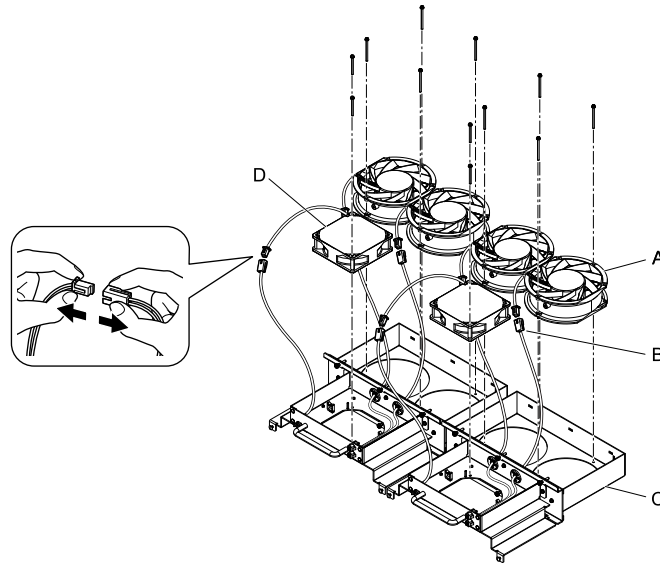

Figure 8.68 Remove the Fan Unit

5. Unplug the relay connector, remove the screws that safety the cooling fans and circulation fan, and then remove the fans.



A - Cooling fan
B - Relay connectors

C - Fan unit base
D - Circulation fan

Figure 8.69 Remove the Cooling Fans and Circulation Fan

■ Fan Installation

Reverse the removal procedure for fan installation.

1. Connect the relay connectors on the fan unit base to the cooling fans and the circulation fan.

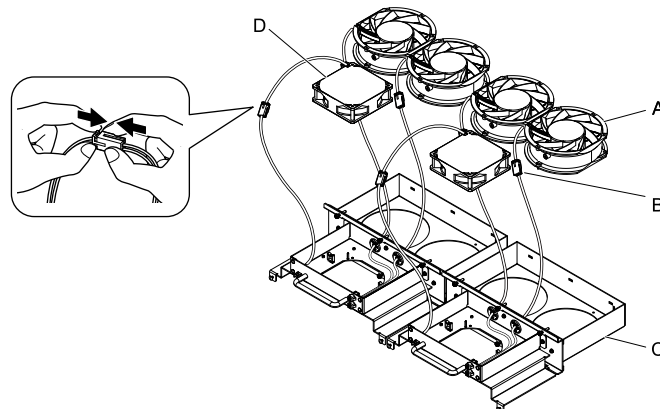

A - Cooling fan
B - Relay connectors

C - Fan unit base
D - Circulation fan

Figure 8.70 Connect the Relay Connector

2. Align the pin on the fan unit base with the notch on the fan and put the fan in the fan unit base, then use the screws to safety it.
Tighten the screws to a correct tightening torque:
 - 0.98 N·m to 1.33 N·m (8.67 lbf·in to 11.77 lbf·in)

Note:

Make sure that you do not pinch cables between the fans and the fan unit base.

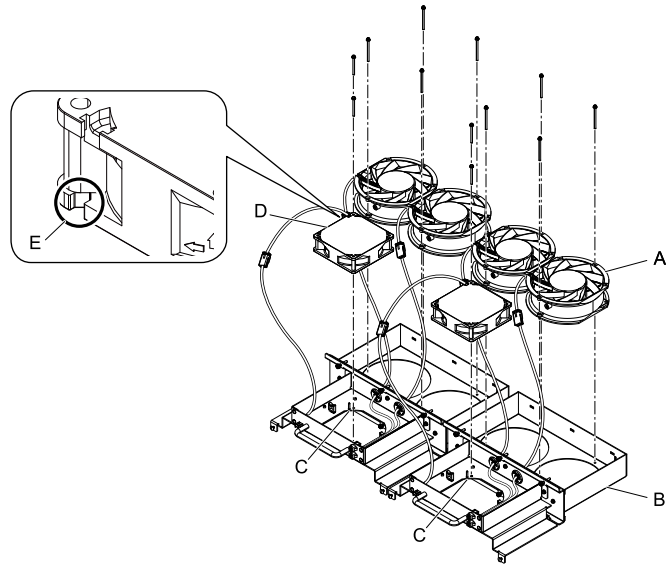

A - Cooling fan
B - Fan unit base

C - Alignment pin on fan unit base

D - Circulation fan
E - Notch on fan

Figure 8.71 Install the Cooling Fans and Circulation Fan

- Put the cables and connectors in the recess of the drive.

Note:

Safety the relay cables to the hooks.

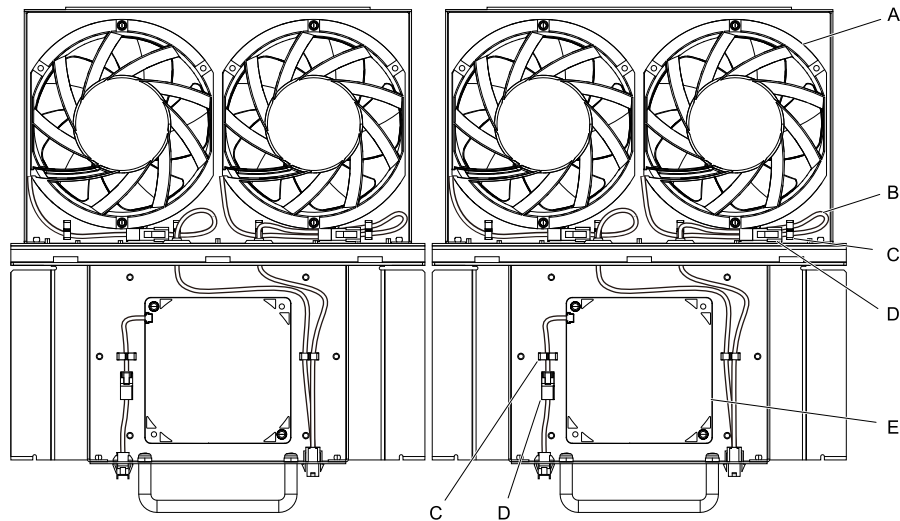

A - Cooling fan
B - Relay cables
C - Cable hooks

D - Relay connectors
E - Circulation fan

Figure 8.72 Put the Cables and Connectors in the Drive Recess

- Put the fan unit into the specified location and use screws to safety it to the drive. Tighten the screws to a correct tightening torque:

- Screws in Position A: 0.98 N·m to 1.33 N·m (8.67 lbf·in to 11.77 lbf·in)
- Screws in Position B: 1.96 N·m to 2.53 N·m (17.35 lbf·in to 22.39 lbf·in)

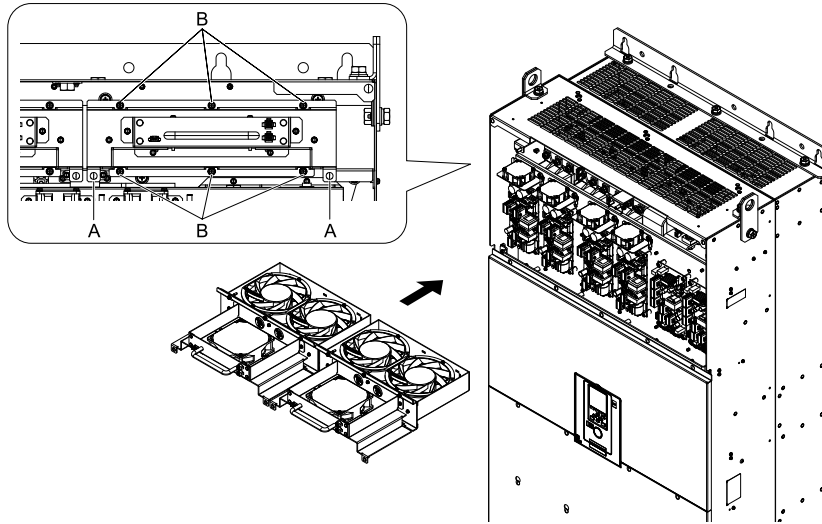

A - Screw position A

B - Screw position B

Figure 8.73 Install the Fan Unit

5. Connect the fan cable to the fan connectors.

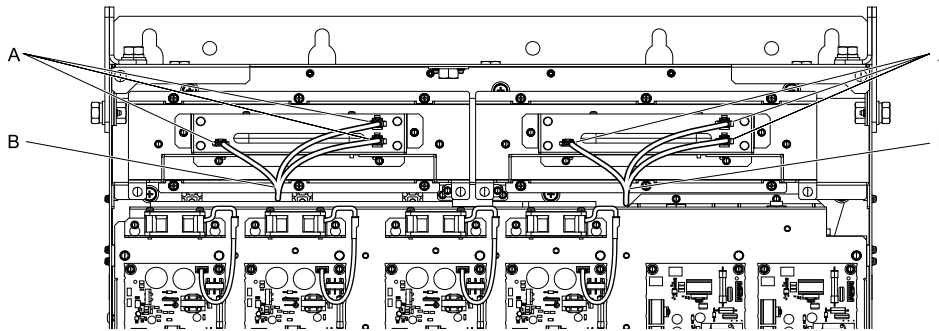

A - Fan connectors

B - Fan cables

Figure 8.74 Connect Cooling Fan Connectors

6. Install the drive cover.
7. Energize the drive and set $o4-03 = 0$ [*Fan Operation Time Setting = 0 h*] to reset the fan operation time.

■ Circuit Board Cooling Fan Removal

Remove the drive cover before you start this procedure.

CAUTION! *Crush Hazard. Loosen the cover screws. Do not fully remove them. If you fully remove the cover screws, the terminal cover can fall and cause moderate injury.*

1. Unplug the fan cables from the fan connectors.

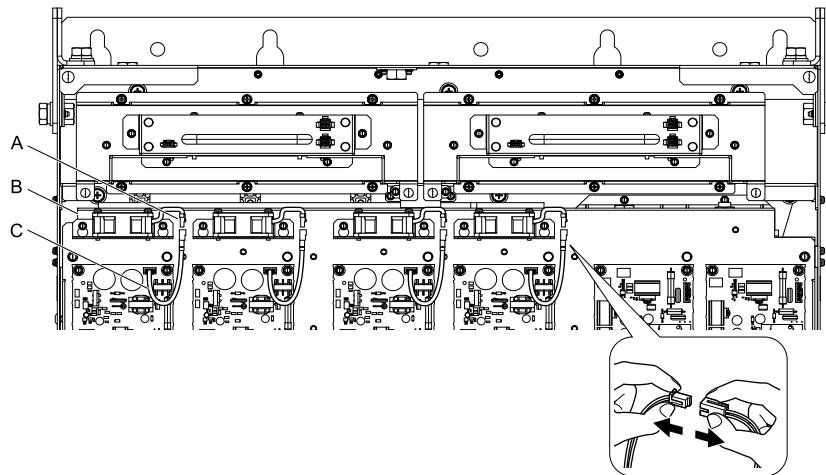

A - Fan connectors
B - Fan cables

C - Circuit board cooling fan units

Figure 8.75 Unplug the Fan Cables

2. Loosen the screws that safety the circuit board cooling fan unit and slide the circuit board cooling fan unit up.

Note:

To remove the fan unit, it is only necessary to loosen the screws.

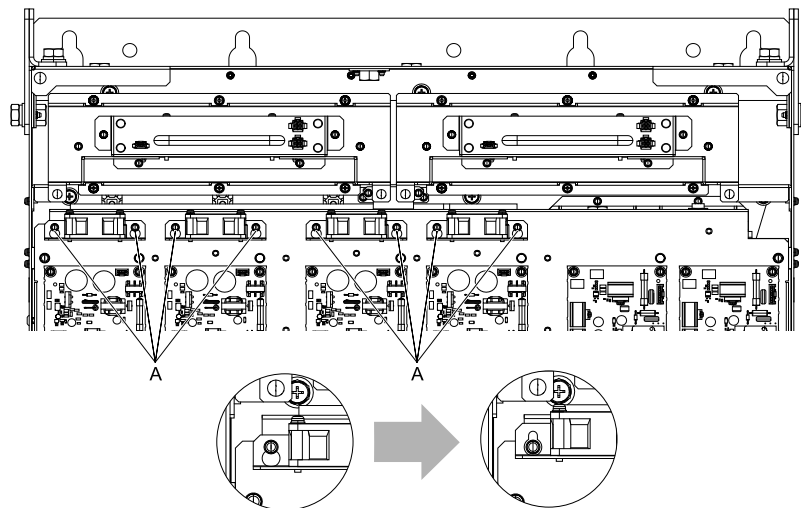

A - Screws

Figure 8.76 Slide the Circuit Board Cooling Fan Units

3. Remove the circuit board cooling fan units.

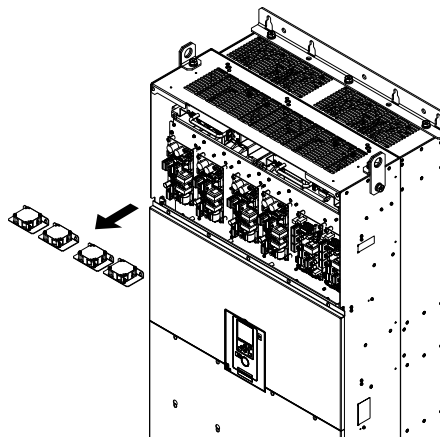
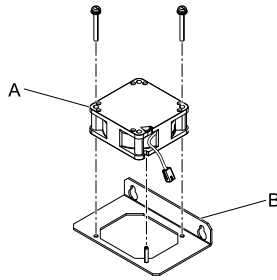

Figure 8.77 Remove the Circuit Board Cooling Fan Units

4. Remove the screws that safety the circuit board cooling fans and remove the fans.



A - Circuit board cooling fan

B - Fan unit base

Figure 8.78 Remove the Circuit Board Cooling Fans

■ Circuit Board Cooling Fan Installation

Reverse the removal procedure to install a cooling fan.

1. Align the pin on the fan unit base with the notch on the fan and put the circuit board cooling fan in the fan unit, then use the screws to safety the circuit board cooling fan to the fan unit base.

Tighten the screws to a correct tightening torque:

- 0.98 N·m to 1.33 N·m (8.67 lbf·in to 11.77 lbf·in)

Note:

Make sure that you do not pinch cables between the circuit board cooling fan and the fan unit base.

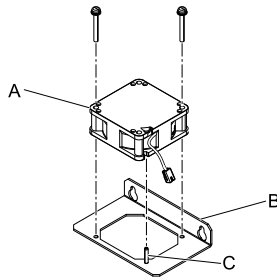

A - Circuit board cooling fan

B - Fan unit base

C - Alignment pin on fan unit base

Figure 8.79 Install the Circuit Board Cooling Fan

2. Put the circuit board cooling fan unit into the specified location and use screws to safety it to the drive.

Tighten the screws to a correct tightening torque:

- 0.98 N·m to 1.33 N·m (8.67 lbf·in to 11.77 lbf·in)

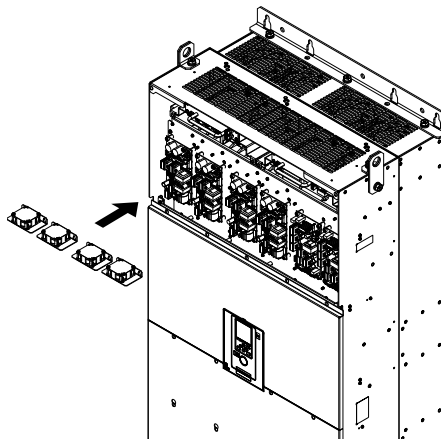
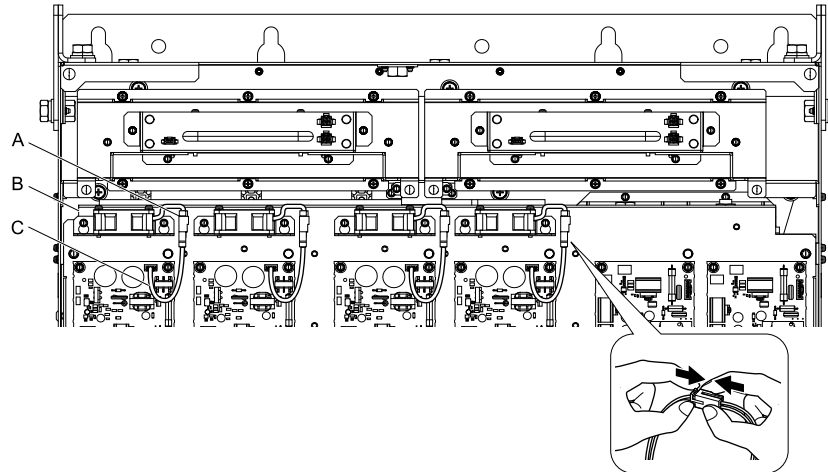

Figure 8.80 Install the Circuit Board Cooling Fan Unit

3. Connect the fan cables to the fan connectors.



A - Fan connectors

B - Circuit board cooling fan units

C - Fan cables

Figure 8.81 Connect the Fan Cables

4. Install the drive cover.
5. Energize the drive and set $o4-03 = 0$ [*Fan Operation Time Setting = 0 h*] to reset the fan operation time.

8.5 Replace the Drive

◆ About the Control Circuit Terminal Block

You can remove the control circuit terminal block of the drive and install a new terminal block. If there is a failure in the drive, you can use this feature to easily replace the control circuit terminal block.

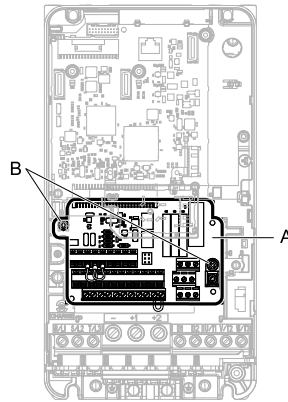

A - Control circuit terminal block

B - Control circuit terminal block fastening screw

Figure 8.82 Control Circuit Terminal Block

◆ Replace the Drive

DANGER! *Electrical Shock Hazard. Disconnect all power to the drive and wait for the time specified on the warning label before you remove covers. Check the drive for dangerous voltages before servicing or repair work. If you do work on the drive when it is energized and there is no cover over the electronic circuits, it will cause serious injury or death from electrical shock. The drive has internal capacitors that stay charged after you de-energize the drive.*

WARNING! *Electrical Shock Hazard. Only let approved personnel install, wire, maintain, examine, replace parts, and repair the drive. If personnel are not approved, it can cause serious injury or death.*

DANGER! *Electrical Shock Hazard. Do not examine, connect, or disconnect wiring on an energized drive. Before servicing, disconnect all power to the equipment and wait for the time specified on the warning label at a minimum. The internal capacitor stays charged after the drive is de-energized. The charge indicator LED extinguishes when the DC bus voltage decreases below 50 Vdc. When all indicators are OFF, remove the covers before measuring for dangerous voltages to make sure that the drive is safe. If you do work on the drive when it is energized, it will cause serious injury or death from electrical shock.*

NOTICE: *Damage to Equipment. When you touch the drive and circuit boards, make sure that you observe correct electrostatic discharge (ESD) procedures. If you do not follow procedures, it can cause ESD damage to the drive circuitry.*

■ Notes on Wiring the Main Circuit Terminal Block

Read these notes before you wire the main circuit terminal block.

- Use UL-Listed, vinyl-coated insulated copper wires for operation with a continuous maximum permitted temperature of 75 °C at 600 V.
- Remove all unwanted objects that are near the terminal block connections.
- Remove the insulation from the connection wires to the wire stripping lengths shown in the manual.
- Do not use bent or crushed wires. Remove the damaged end of the wire before you use it. Incorrect connections can cause death or serious injury from fire.
- Do not solder stranded wire. Soldered wire connections can become loose over time and cause unsatisfactory drive performance.
- If you use stranded wire, make sure that all of the wire strands are in the connection. Also, do not twist the stranded wire too much. Incorrect connections can cause death or serious injury from fire.
- Put the wire all the way into the terminal block. Remove the insulation from the wire to the recommended wire stripping length to fit the wire with insulation in the plastic housing.
- Use a torque driver, torque ratchet, or torque wrench for the screws. A slotted driver or a hex tool will be necessary to wire the screw clamp terminal. Use applicable tools as specified by the recommended conditions in the product manual.
- If you use power tools to tighten the terminal screws, use a low speed setting (300 to 400 r/min). Failure to obey can cause damage to the terminal screws.
- Wire gauges on existing drive models to be replaced may not match wire gauge ranges on new drives. Refer to the drive manuals for correct wire sizes.

- Do not tighten the terminal screws at an angle of 5 degrees or more. Failure to obey can cause damage to the terminal screws.
- If you damage a terminal screw, contact Yaskawa or your nearest sales representative.

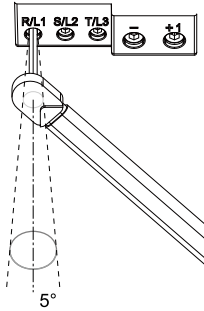

Figure 8.83 Permitted Angle

- Put the bit all the way into the hex socket to tighten the hex socket cap screw.
- When you tighten slotted screws, hold the straight-edge screwdriver perpendicularly to the screw. Make sure that you align the end of the straight-edge screwdriver with the screw groove.

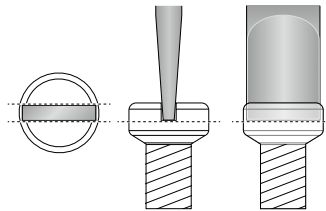
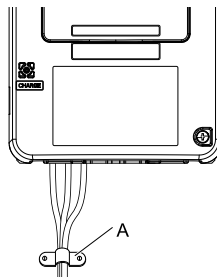

Figure 8.84 Tightening Slotted Screws

- After you connect the wires to the terminal block, lightly pull on the wires to make sure that they do not come out of the terminals.
- Remove the correct section of the wiring cover to make wiring easier.
- Do not let strain on the wiring cause damage. Use a strain relief near the wiring to release the tension. Refer to [Figure 8.85](#) for an example.







A - Cable clamp

Figure 8.85 Strain Relief Example

Table 8.13 Recommended Wiring Tools

Screw Size	Screw Shape	Adapter	Bit		Torque Driver Model (Tightening Torque)	Torque Wrench
			Model	Manufacturer		
M4	⊖	Bit	SF-BIT-SL 1,0X4,0-70	PHOENIX CONTACT	TSD-M 3NM (1.2 - 3 N·m (10.6 - 26.6 lbf·in))	N/A
M5 ^{*1}	⊖	Bit	SF-BIT-SL 1,2X6,5-70	PHOENIX CONTACT	Wire Gauge ≤ 25 mm ² (AWG 10); TSD-M 3NM (1.2 - 3 N·m (10.6 - 26.6 lbf·in))	Wire Gauge ≤ 25 mm ² (AWG 10); N/A
					Wire Gauge ≥ 30 mm ² (AWG 8): N/A	Wire Gauge ≥ 30 mm ² (AWG 8): 4.1 - 4.5 N·m (36.3 - 39.8 lbf·in) ^{*2} ^{*3}

8.5 Replace the Drive

Screw Size	Screw Shape	Adapter	Bit		Torque Driver Model (Tightening Torque)	Torque Wrench
			Model	Manufacturer		
M6		Bit	SF-BIT-HEX 5-50	PHOENIX CONTACT	N/A	5 - 9 N·m (44.3 - 79.9 lbf·in) *2 *3
		Bit	SF-BIT-SL 1,2X6,5-70	PHOENIX CONTACT	N/A	3 - 3.5 N·m (26.6 - 31.0 lbf·in) *2 *3
M8		Bit	SF-BIT-HEX 6-50	PHOENIX CONTACT	N/A	8 - 12 N·m (70.8 - 106.2 lbf·in) *2 *3
M10		Bit	SF-BIT-HEX 8-50	PHOENIX CONTACT	N/A	12 - 14 N·m (106.2 - 123.9 lbf·in) *2 *3

*1 When wiring drive models 2056, 4089, and smaller, select the correct tools for the wire gauge.

*2 Use 6.35 mm (0.25 in) bit socket holder.

*3 Use a torque wrench that can apply this torque measurement range.

■ Remove the Control Circuit Terminal Block

Remove the keypad and the drive front cover before doing these steps.

1. Loosen the screws on the control circuit terminal block.

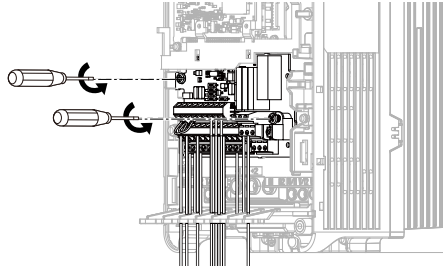

Figure 8.86 Loosen the Screws

2. Slide the wired control circuit terminal block down and remove it.

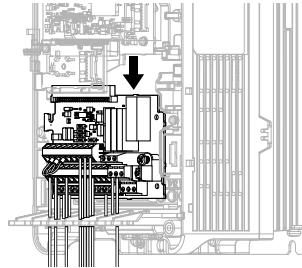
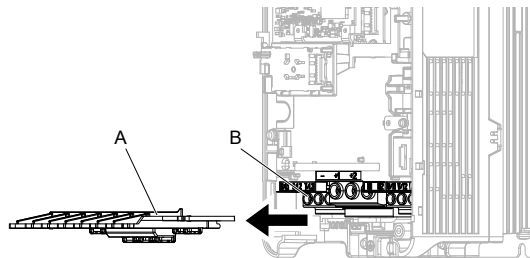

Figure 8.87 Remove the Control Circuit Terminal Block

■ Wire a New Drive

Remove the keypad, front cover, and control circuit terminal block of the new drive. Wire the drive to the main circuit terminal block before you install a wired control circuit terminal block.

1. Pull the wiring cover away from the drive to remove it.



A - Wiring cover

B - Main circuit terminal block

Figure 8.88 Remove the Wiring Cover

- Loosen the main circuit terminal block screws to fully open the terminal block opening.

Note:

The terminal block openings ship from the factory as fully open.

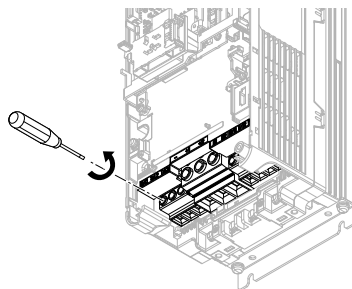

Figure 8.89 Loosen Terminal Block Screws

- Put wires with prepared ends into the main circuit terminal block.

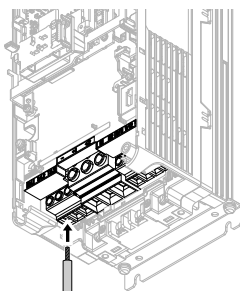

Figure 8.90 Install the Electrical Wire

Note:

If there is a jumper between terminals +1 and +2, loosen the terminal block screws to remove the jumper before you wire to terminals +1 and +2.

- Tighten the screws to the specified torque.

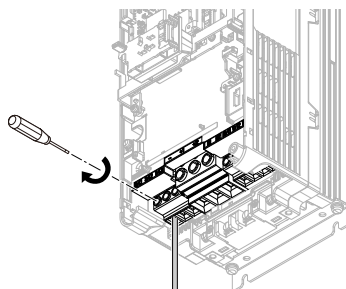
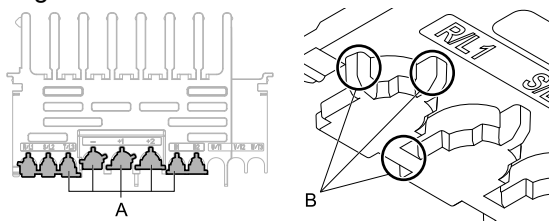

Figure 8.91 Tighten Terminal Block Screws

- Check the terminal sign that you wired and use a nipper as shown in [Figure 8.92](#) to clip the specified cutaway section of the wiring cover.



A - Cutaway sections

B - Clip here with nippers

Figure 8.92 Clip the Cutaway Section of the Wiring Cover

Note:

- Different drive models have different wiring cover shapes.
- Only clip the section of the wiring cover that applies to the wired terminal. If you clip areas that do not apply to wired terminals, the protective enclosure will not keep its IP20 protective level.
- Be careful when clipping the cutaway section of the wiring cover, as the section may fly out in unpredictable directions.
- Make sure that the clipped section does not cause damage to the wires.
- If you use wires that are not specified by Yaskawa, the protective enclosure could lose its IP20 protective level, although the wiring cover is correct. Contact Yaskawa or your nearest sales representative for more information.

- Put the wiring cover in its initial position. Put the cables through the holes that you cut out of the wiring cover.

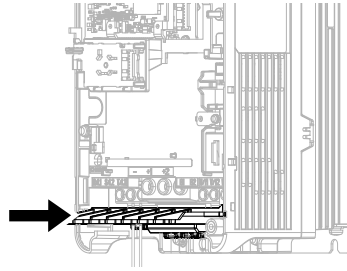
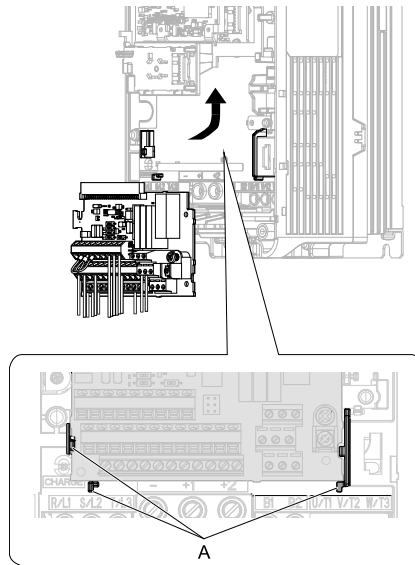

Figure 8.93 Reattach the Wiring Cover

■ Connect the Control Circuit Terminal Block

- To put a wired control circuit terminal block in the drive, align it with the guides and move it straight up.



A - Guides

Figure 8.94 Put the Terminal Block into the Connector

- Use M3 screws to safety the terminal block.
Tighten the screws to a correct tightening torque:
 - M3 screws: 0.5 N·m to 0.6 N·m (4.4 lbf·in to 5.3 lbf·in)

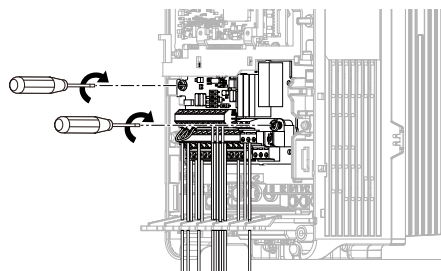

Figure 8.95 Safety the Terminal Block

- Install the front cover and the keypad to their initial positions.
- Check *o2-04 [Drive Model (KVA) Selection]*.

Note:

- When you save parameter information in a keypad that you installed before you replaced the terminal block, make sure that you use that keypad to restore the parameter data.
- To reset the performance life monitors for the components, set *o4-01 to o4-13 [Maintenance Period]*.

8.6 Replace the Keypad Battery

When the keypad battery is expired, the date and time go back to the default settings. Use this procedure to replace the battery.

WARNING! Fire Hazard. Handle keypad batteries properly. Do not charge the battery or disassemble the keypad. If the battery explodes, it can cause a fire.

To replace the battery, use a Hitachi Maxell “CR2016 Lithium Manganese Dioxide Lithium Battery” or an equivalent battery with these properties:

- Nominal voltage: 3 V
- Operating temperature range: -20°C to +85°C (-4°F to +185°F)

WARNING! Fire Hazard. Do not disassemble batteries. Do not expose batteries to heat or fire. If the battery explodes, it can cause a fire.

NOTICE: Damage to Equipment. The keypad battery stays in use after you de-energize the drive. When you will keep the drive de-energized for long periods of time, remove the battery from the keypad. When the expected life of the battery is complete, replace the battery immediately. A dead battery in the keypad can leak and cause damage to the keypad and drive.

The performance life estimate of a new battery is different for different keypad versions.

Refer to “REV” on the keypad nameplate for the keypad version.

- Keypad with REV: H and earlier or REV: J and later
 - 5 years (20 °C (68 °F))
 - 3.5 years (-10 °C to +50 °C (14 °F to 122 °F))
 - Keypad with REV: I
 - 2.5 years (20 °C (68 °F))
 - 1.8 years (-10 °C to +50 °C (14 °F to 122 °F))
1. De-energize the drive and remove the keypad.
 2. Use a slotted screwdriver to turn the battery cover counterclockwise and remove the cover.

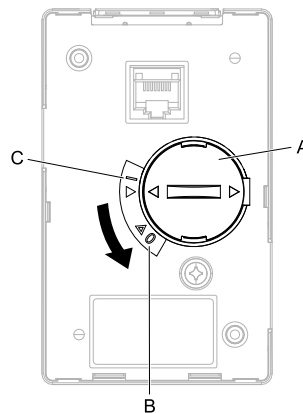

A - Battery cover

B - Opened

C - Closed

Figure 8.96 Remove the Battery Cover

3. Remove the used battery from the keypad.
4. Insert the new battery.

Note:

- The battery cover side is the positive pole. Make sure that the polarity is correct when you put the battery in the keypad.
- Discard the used battery as specified by local regulations.

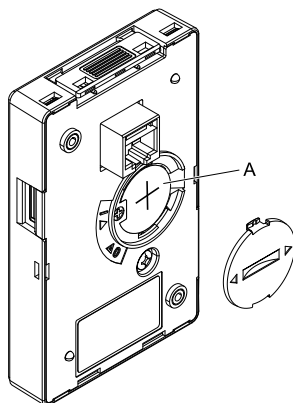

A - Battery

Figure 8.97 Insert the New Battery

5. Put the battery cover on the keypad and use a slotted screwdriver to turn the battery cover clockwise to close it.
6. Install the keypad on the drive.

8.7 Storage Guidelines

The chemicals in the electrolytic capacitors and other electronic parts of the drive change over time. When you store the drive for long periods of time, use the information in this section to help keep the performance life estimates.

◆ Storage Location

- Temperature and Humidity

When you store the drive for approximately one month, for example during shipping, you can put the drive in a location where the temperature is $-20\text{ }^{\circ}\text{C}$ to $+70\text{ }^{\circ}\text{C}$ ($-4\text{ }^{\circ}\text{F}$ to $+158\text{ }^{\circ}\text{F}$). Correctly package and store the drive during shipping to prevent vibration and impact damage.

Do not put the drive in direct sunlight or where there will be condensation or ice. Put the drive in a location where the relative humidity is 95% or less.

- Dust and Oil Mist

Do not keep the drive locations with dust or oil mist. For example, cement factories and cotton mills.

- Corrosive Gas

Do not keep the drive in locations with corrosive gas. For example, chemical plants, refineries, and sewage plants.

- Salt Damage

Do not keep the drive in salty locations. For example, locations near the ocean, and salt damage-designated locations.

Do not keep the drive in unsatisfactory locations. Keep all drives in storage rooms that are safe from unsatisfactory elements.

◆ Regular Application of Power

To prevent deterioration of the capacitors, Yaskawa recommends that you apply power to the drive a minimum of one time each year for a minimum of 30 minutes.

If you store the drive for longer than two years and do not apply power, Yaskawa recommends that you use a variable power source and gradually increase the power from 0 V to the rated drive voltage over a period of 2 to 3 minutes. Apply power for a minimum of 1 hour with no load to reform the main circuit electrolytic capacitor. When you operate the drive after you apply power, wire the drive correctly and check for drive faults, overcurrents, motor vibration, motor speed differences, and other defects during operation.

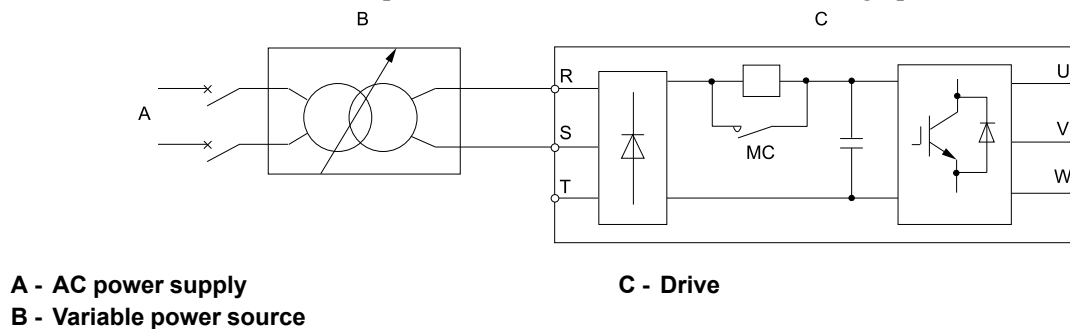

Figure 8.98 Power Distribution Method

Disposal

9.1	Section Safety	452
9.2	Disposal Instructions	453

9.1 Section Safety

WARNING

Electrical Shock Hazard

De-energize the drive and wait 5 minutes minimum until the Charge LED turns off. Remove the front cover and terminal cover to do work on wiring, circuit boards, and other parts. Use terminals for their correct function only.

Incorrect wiring, incorrect ground connections, and incorrect repair of protective covers can cause death or serious injury.

Only let approved personnel install, wire, maintain, examine, replace parts, and repair the drive.

If personnel are not approved, it can cause serious injury or death.

Do not wear loose clothing or jewelry when you do work on the drive. Tighten loose clothing and remove all metal objects, for example watches or rings.

Loose clothing can catch on the drive and jewelry can conduct electricity and cause serious injury or death.

Fire Hazard

Handle keypad batteries properly. Do not charge the battery or disassemble the keypad.

If the battery explodes, it can cause a fire.

Do not disassemble batteries. Do not expose batteries to heat or fire.

If the battery explodes, it can cause a fire.

Crush Hazard

Wear eye protection when you do work on the drive.

If you do not use correct safety equipment, it can cause serious injury or death.

Only approved personnel can operate a crane or hoist to move the drive.

If unapproved personnel operate a crane or hoist, it can cause serious injury or death from falling equipment.

Use a crane or hoist to move large drives when necessary.

If you try to move a large drive without a crane or hoist, it can cause serious injury or death.

CAUTION

Crush Hazard

Tighten terminal cover screws and hold the case safely when you move the drive.

If the drive or covers fall, it can cause moderate injury.

NOTICE

Damage to Equipment

The keypad battery stays in use after you de-energize the drive. When you will keep the drive de-energized for long periods of time, remove the battery from the keypad. When the expected life of the battery is complete, replace the battery immediately.

A dead battery in the keypad can leak and cause damage to the keypad and drive.

9.2 Disposal Instructions

Correctly discard the drive, packing material, battery, and microSD card as specified by regional, local, and municipal laws and regulations for this product.

Note:

- Remove the battery and microSD card from the keypad before you discard the drive.
- You cannot recycle the battery. Discard used batteries as specified by the battery manufacturer.
- Customers are responsible for microSD card data protection.
PC functions that format and delete the data may not be sufficient to fully erase the microSD card data. Yaskawa recommends that customers physically destroy the microSD card in a shredder or use data wipe software to fully erase the card.

◆ WEEE Directive

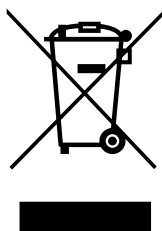

The wheelie bin symbol on this product, its manual, or its packaging identifies that you must recycle it at the end of its product life.

You must discard the product at an applicable collection point for electrical and electronic equipment (EEE). Do not discard the product with usual waste.

Specifications

10.1	Section Safety	456
10.2	Drive Duty Modes	457
10.3	Model-Specific Specifications (200 V Class).....	458
10.4	Model-Specific Specifications (400 V Class).....	461
10.5	Drive Specifications.....	467
10.6	Drive Derating	470
10.7	Drive Exterior and Mounting Dimensions.....	476
10.8	Knock-Out Hole Dimensions (IP20/UL Type 1).....	496
10.9	Peripheral Devices and Options.....	501

10.1 Section Safety

 **DANGER**

Do not ignore the safety messages in this manual.

If you ignore the safety messages in this manual, it will cause serious injury or death. The manufacturer is not responsible for injuries or damage to equipment.

10.2 Drive Duty Modes

The drive has two duty modes from which to select for the application: Heavy Duty (HD) and Normal Duty (ND).

Note:

The drive has two duty modes from which to select for the application: Heavy Duty (HD1/2) and Normal Duty (ND1/2). When *E1-01 [Input AC Supply Voltage]* ≥ 460 V, the duty rating switches to HD2 or ND2. The specifications listed here are different between HD1 and HD2 and ND1 and ND2.

- The input power kVA
- The maximum applicable motor output
- The rated input current
- The rated output capacity
- The rated output current

The rated output current of HD/ND is the reference to set the parameter as a percentage of the drive rated output current. Refer to [Table 10.1](#) for information about the differences between HD and ND ratings.

Table 10.1 Drive Duty Modes

Duty Rating	E1-01 Setting Input Voltage	C6-01 Setting	Application	Default Carrier Frequency	Overload Tolerance (oL2 [Drive Overload])
Heavy Duty Rating 1 (HD1)	<ul style="list-style-type: none"> • ≥ 200 V and < 240 V • ≥ 380 V and < 460 V 	0	<ul style="list-style-type: none"> • Extruder • Conveyor • Constant torque or high overload capacity 	2 kHz	150% of the rated output current for 60 seconds The permitted frequency of overload is one time each 10 minutes.
Heavy Duty Rating 2 (HD2)	≥ 460 V and < 480 V				
Normal Duty Rating 1 (ND1)	<ul style="list-style-type: none"> • ≥ 200 V and < 240 V • ≥ 380 V and < 460 V 	1	<ul style="list-style-type: none"> • Fan • Pump • Blower • Variable speed control 	<ul style="list-style-type: none"> • Models 2004 to 2415, 4002 to 4720: 2 kHz Swing-PWM • Models 4810 to 4H12: 2 kHz 	110% of the rated output current for 60 seconds The permitted frequency of overload is one time each 10 minutes.
Normal Duty Rating 2 (ND2)	≥ 460 V and < 480 V				

10.3 Model-Specific Specifications (200 V Class)

Table 10.2 Rating (200 V Class)

Model		2004	2006	2010	2012	2018	2021	2030	2042	
Maximum Applicable Motor Output (kW)	HD1 *1	0.55	0.75	1.5	2.2	3	3.7	5.5	7.5	
	ND1 *2	0.75	1.1	2.2	3	3.7	5.5	7.5	11	
Maximum Applicable Motor Output (HP)	HD1 *1	1/2	1	2	3	4	5	7 1/2	10	
	ND1 *2	3/4	1 1/2	3	4	5	7 1/2	10	15	
Input	Rated Input Current (A)	HD1 (AC)	3.6	4.8	8.9	12.7	17	20.7	30	40.3
		HD1 (DC)	4.5	5.9	10.9	15.6	20.8	25.3	36.8	49.4
		ND1 (AC)	4.8	6.7	12.7	17	20.7	30	40.3	52
		ND1 (DC)	5.9	8.2	15.6	20.8	25.3	36.8	49.4	71.3
Output	Rated Output Capacity (kVA)	HD1 *3	1.2	1.9	3.0	4.2	5.3	6.7	9.5	12.6
		ND1 *4	1.3	2.3	3.7	4.6	6.7	8.0	11.4	16.0
	Rated Output Current (A)	HD1	3.2	5	8	11	14	17.5	25	33
		ND1	3.5	6	9.6	12.2	17.5	21	30	42
	Overload Tolerance		<ul style="list-style-type: none"> HD: 150% of the rated output current for 60 seconds. The permitted frequency of overload is one time each 10 minutes. ND: 110% of the rated output current for 60 seconds. The permitted frequency of overload is one time each 10 minutes. Note: Derating can be necessary for applications that start and stop frequently.							
	Carrier Frequency		HD: 8 kHz without derating the drive capacity. ND: 2 kHz without derating the drive capacity. Derate the drive capacity to use values to 15 kHz maximum.							
	Maximum Output Voltage		Three-phase 200 V to 240 V Note: The maximum output voltage is proportional to the input voltage.							
	Maximum Output Frequency		<ul style="list-style-type: none"> AOLV and EZOLV: 120 Hz CL-V/f, CLV, AOLV/PM, and CLV/PM: 400 Hz V/f, OLV, OLV/PM: 590 Hz 							
Measures for Harmonics	DC reactor	External options								
Braking Device	Braking Transistor	Standard internal characteristics								
EMC Filter	EMC Filter IEC 61800-3, C3	Factory option <ul style="list-style-type: none"> Models 2xxxB: There is a category C3 EMC filter in the drive. 								
Power Supply	Rated Voltage, Rated Frequency		<ul style="list-style-type: none"> Three-phase AC power supply 200 V to 240 V at 50/60 Hz DC power supply 270 V to 340 V 							
	Permitted Voltage Fluctuation		-15% to +10%							
	Permitted Frequency Fluctuation		±5%							
	Input Power (kVA)	HD1	1.5	2.0	3.7	5.3	7.1	8.6	12.5	16.8
ND1		2.0	2.8	5.3	7.1	8.6	12.5	16.8	21.6	

*1 The maximum applicable motor output complies with 208 V motor ratings as specified in NEC Table 430.250. The rated output current of the drive output amps must be equal to or more than the motor rated current.

*2 The maximum applicable motor output is based on 4-pole, general-purpose 220 V motor ratings. The rated output current of the drive output amps must be equal to or more than the motor rated current.

*3 The rated output capacity is calculated with a rated output voltage of 208 V.

*4 The rated output capacity is calculated with a rated output voltage of 220 V.

Table 10.3 Rating (200 V Class)

Model		2056	2070	2082	2110	2138
Maximum Applicable Motor Output (kW)	HD1 *1	11	15	18.5	22	30
	ND1 *2	15	18.5	22	30	37
Maximum Applicable Motor Output (HP)	HD1 *1	15	20	25	30	40
	ND1 *2	20	25	30	40	50

Model		2056	2070	2082	2110	2138	
Input	Rated Input Current (A)	HD1 (AC)	58.2	78.4	96	82	111
		HD1 (DC)	71.3	96	118	100	136
		ND1 (AC)	78.4	96	114	111	136
		ND1 (DC)	96	117.6	139	136	166
Output	Rated Output Capacity (kVA)	HD1 *3	17.9	22.9	28.6	33.5	43.8
		ND1 *4	21.3	26.7	31.2	41.9	52.6
	Rated Output Current (A)	HD1	47	60	75	88	115
		ND1	56	70	82	110	138
	Overload Tolerance	<ul style="list-style-type: none"> HD: 150% of the rated output current for 60 seconds. The permitted frequency of overload is one time each 10 minutes. ND: 110% of the rated output current for 60 seconds. The permitted frequency of overload is one time each 10 minutes. Note: Derating can be necessary for applications that start and stop frequently.					
	Carrier Frequency	HD: 8 kHz without derating the drive capacity. ND: 2 kHz without derating the drive capacity. Derate the drive capacity to use values to 15 kHz maximum.					
Maximum Output Voltage	Three-phase 200 V to 240 V Note: The maximum output voltage is proportional to the input voltage.						
Maximum Output Frequency	<ul style="list-style-type: none"> AOLV and EZOLV: 120 Hz CL-V/f, CLV, AOLV/PM, and CLV/PM: 400 Hz V/f, OLV, OLV/PM: 590 Hz 						
Measures for Harmonics	DC reactor	External options				Standard internal characteristics	
Braking Device	Braking Transistor	Standard internal characteristics					
EMC Filter	EMC Filter IEC 61800-3, C3	Factory option <ul style="list-style-type: none"> Models 2xxxB: There is a category C3 EMC filter in the drive. 					
Power Supply	Rated Voltage, Rated Frequency		<ul style="list-style-type: none"> Three-phase AC power supply 200 V to 240 V at 50/60 Hz DC power supply 270 V to 340 V 				
	Permitted Voltage Fluctuation		-15% to +10%				
	Permitted Frequency Fluctuation		±5%				
	Input Power (kVA)	HD1	24.2	32.6	39.9	34.1	46.1
ND1		32.6	39.9	47.4	46.1	56.5	

- *1 The maximum applicable motor output complies with 208 V motor ratings as specified in NEC Table 430.250. The rated output current of the drive output amps must be equal to or more than the motor rated current.
- *2 The maximum applicable motor output is based on 4-pole, general-purpose 220 V motor ratings. The rated output current of the drive output amps must be equal to or more than the motor rated current.
- *3 The rated output capacity is calculated with a rated output voltage of 208 V.
- *4 The rated output capacity is calculated with a rated output voltage of 220 V.

Table 10.4 Rating (200 V Class)

Model		2169	2211	2257	2313	2360	2415	
Maximum Applicable Motor Output (kW)	HD1 *1	37	45	55	75	90	110	
	ND1 *2	45	55	75	90	110	-	
Maximum Applicable Motor Output (HP)	HD1 *1	50	60	75	100	125	150	
	ND1 *2	60	75	100	125	150	-	
Input	Rated Input Current (A)	HD1 (AC)	136	164	200	271	324	394
		HD1 (DC)	166	201	245	331	396	482
		ND1 (AC)	164	200	271	324	394	-
		ND1 (DC)	201	245	331	396	482	-

10.3 Model-Specific Specifications (200 V Class)

Model		2169	2211	2257	2313	2360	2415	
Output	Rated Output Capacity (kVA)	HD1 ^{*3}	55.3	68.6	81.9	108	132	158
		ND1 ^{*4}	64.4	80.4	97.9	119	137	
	Rated Output Current (A)	HD1	145	180	215	283	346	415
		ND1	169	211	257	313	360	-
	Overload Tolerance	<ul style="list-style-type: none"> HD: 150% of the rated output current for 60 seconds. The permitted frequency of overload is one time each 10 minutes. ND: 110% of the rated output current for 60 seconds. The permitted frequency of overload is one time each 10 minutes. <p>Note: Derating can be necessary for applications that start and stop frequently.</p>						
	Carrier Frequency	HD: 5 kHz without derating the drive capacity. ND: 2 kHz without derating the drive capacity. Derate the drive capacity to use values to 10 kHz maximum.						
	Maximum Output Voltage (V)	Three-phase 200 V to 240 V Note: The maximum output voltage is proportional to the input voltage.						
Maximum Output Frequency	<ul style="list-style-type: none"> AOLV and EZOLV: 120 Hz CL-V/f, CLV, AOLV/PM, and CLV/PM: 400 Hz V/f, OLV, OLV/PM: 590 Hz 							
Measures for Harmonics	DC reactor	Standard internal characteristics						
Braking Device	Braking Transistor	External options						
EMC Filter	EMC Filter IEC 61800-3, C3	Factory option <ul style="list-style-type: none"> Models 2xxxB: There is a category C3 EMC filter in the drive. 						
Power Supply	Rated Voltage, Rated Frequency		<ul style="list-style-type: none"> Three-phase AC power supply 200 V to 240 V at 50/60 Hz DC power supply 270 V to 340 V 					
	Permitted Voltage Fluctuation		-15% to +10%					
	Permitted Frequency Fluctuation		±5%					
	Input Power (kVA)	HD1	56.5	68.2	83.1	113	135	164
ND1		68.2	83.1	113	135	164	-	

*1 The maximum applicable motor output complies with 208 V motor ratings as specified in NEC Table 430.250. The rated output current of the drive output amps must be equal to or more than the motor rated current.

*2 The maximum applicable motor output is based on 4-pole, general-purpose 220 V motor ratings. The rated output current of the drive output amps must be equal to or more than the motor rated current.

*3 The rated output capacity is calculated with a rated output voltage of 208 V.

*4 The rated output capacity is calculated with a rated output voltage of 220 V.

10.4 Model-Specific Specifications (400 V Class)

Table 10.5 Rating (400 V Class)

Model	Input Voltage	Duty Rating	4002	4004	4005	4007	4009	4012	4018	4023	
Maximum Applicable Motor Output (kW)	< 460 V *1	HD1	0.55	1.1	1.5	2.2	3.0	4.0	5.5	7.5	
		ND1	0.75	1.5	2.2	3.0	4.0	5.5	7.5	11	
	≥ 460 V *2	HD2	0.55	0.75	1.5	2.2	3	3.7	5.5	7.5	7.5
		ND2	0.75	1.5	2.2	3	3.7	5.5	7.5	7.5	11
Maximum Applicable Motor Output (HP)	< 460 V *1	HD1	3/4	1.5	2	3	4	5	7.5	10	
		ND1	1	2	3	4	5	7.5	10	15	
	≥ 460 V *2	HD2	3/4	1	2	3	4	5	7.5	10	
		ND2	1	2	3	4	5	7.5	10	15	
Input	Rated Input Current (A)	< 460 V	HD1 (AC)	1.9	3.5	4.7	6.7	8.9	11.7	15.8	21.2
			HD1 (DC)	2.3	4.3	5.8	8.2	10.9	14.3	19.4	26.0
			ND1 (AC)	2.5	4.7	6.7	8.9	11.7	15.8	21.2	30.6
			ND1 (DC)	3.1	5.8	8.2	10.9	14.3	19.4	26.0	37.5
		≥ 460 V	HD2 (AC)	1.6	2.1	3.9	5.5	7.4	9.0	13.1	17.5
			HD2 (DC)	1.9	2.5	4.8	6.8	9.0	11.0	16.0	21.5
			ND2 (AC)	2.1	3.9	5.5	7.4	9.0	13.1	17.5	25.3
			ND2 (DC)	2.5	4.8	6.8	9.0	11.0	16.0	21.5	31.0
Output	Rated Output Capacity (kVA)	< 460 V *3	HD1	1.2	2.2	3.2	3.6	4.7	6.1	10	12
			ND1	1.4	2.7	3.6	4.7	5.9	7.8	12	15
		≥ 460 V *4	HD2	1.3	1.7	2.7	3.8	5.5	6.1	8.8	11
			ND2	1.7	2.7	3.8	5.5	6.1	8.8	11	17
	Rated Output Current (A)	< 460 V	HD1	1.8	3.4	4.8	5.5	7.2	9.2	14.8	18
			ND1	2.1	4.1	5.4	7.1	8.9	11.9	17.5	23.4
		≥ 460 V	HD2	1.6	2.1	3.4	4.8	6.9	7.6	11	14
			ND2	2.1	3.4	4.8	6.9	7.6	11	14	21
Overload Tolerance			<ul style="list-style-type: none"> HD: 150% of the rated output current for 60 seconds. The permitted frequency of overload is one time each 10 minutes. ND: 110% of the rated output current for 60 seconds. The permitted frequency of overload is one time each 10 minutes. <p>Note: Derating can be necessary for applications that start and stop frequently.</p>								
	Carrier Frequency		HD: 8 kHz without derating the drive capacity. ND: 2 kHz without derating the drive capacity. Derate the drive capacity to use values to 15 kHz maximum.								
	Maximum Output Voltage		Three-phase 380 V to 480 V Note: The maximum output voltage is proportional to the input voltage.								
	Maximum Output Frequency		<ul style="list-style-type: none"> AOLV and EZOLV: 120 Hz CL-V/f, CLV, AOLV/PM, and CLV/PM: 400 Hz V/f, OLV, OLV/PM: 590 Hz 								
Measures for Harmonics	DC reactor	External options									
Braking Device	Braking Transistor	Standard internal characteristics									
EMC Filter	EMC Filter IEC 61800-3, C3	Factory option <ul style="list-style-type: none"> Models 4xxxB: There is a category C3 EMC filter in the drive. 									

10.4 Model-Specific Specifications (400 V Class)

Model	Input Voltage	Duty Rating	4002	4004	4005	4007	4009	4012	4018	4023	
Power Supply	Rated Voltage, Rated Frequency		<ul style="list-style-type: none"> Three-phase AC power supply 380 V to 480 V at 50/60 Hz DC power supply 513 V to 679 V 								
	Permitted Voltage Fluctuation		-15% to +10%								
	Permitted Frequency Fluctuation		±5%								
	Input Power (kVA)	< 460 V	HD1	1.5	2.8	3.7	5.3	7.1	9.3	13	17
			ND1	2.0	3.7	5.3	7.1	9.3	13	17	24
	≥ 460 V	HD2	1.3	1.7	3.2	4.6	6.2	7.5	11	15	
		ND2	1.7	3.2	4.6	6.2	7.5	11	15	21	

*1 The maximum applicable motor output complies with 380 V motor ratings as specified in Annex G of IEC 60947-4-1. The rated output current of the drive output amps must be equal to or more than the motor rated current.

*2 The maximum applicable motor output complies with 460 V motor ratings as specified in NEC Table 430.250. The rated output current of the drive output amps must be equal to or more than the motor rated current.

*3 The rated output capacity is calculated with a rated output voltage of 380 V.

*4 The rated output capacity is calculated with a rated output voltage of 460 V.

Table 10.6 Rating (400 V Class)

Model	Input Voltage	Duty Rating	4031	4038	4044	4060	4075	4089	4103	
Maximum Applicable Motor Output (kW)	< 460 V *1	HD1	11	15	18.5	22	30	37	45	
		ND1	15	18.5	22	30	37	45	55	
	≥ 460 V *2	HD2	11	15	18.5	22	30	37	45	
		ND2	15	18.5	22	30	37	45	55	
Maximum Applicable Motor Output (HP)	< 460 V *1	HD1	15	20	25	30	40	50	60	
		ND1	20	25	30	40	50	60	75	
	≥ 460 V *2	HD2	15	20	25	30	40	50	60	
		ND2	20	25	30	40	50	60	75	
Input	Rated Input Current (A)	< 460 V	HD1 (AC)	30.6	41.3	50.5	43.1	58.3	71.5	86.5
			HD1 (DC)	37.5	50.5	61.9	52.8	71.4	87.5	106.0
			ND1 (AC)	41.3	50.5	59.7	58.3	71.5	86.5	105
			ND1 (DC)	50.5	61.9	73.2	71.4	87.5	106.0	129
		≥ 460 V	HD2 (AC)	25.3	34.1	41.7	35.6	48.1	59.0	71.4
			HD2 (DC)	31.0	41.8	51.1	43.7	59.0	72.3	87.5
			ND2 (AC)	34.1	41.7	49.4	48.1	59.0	71.4	86.9
			ND2 (DC)	41.8	51.1	60.4	59.0	72.3	87.5	106.0

Model		Input Voltage	Duty Rating	4031	4038	4044	4060	4075	4089	4103	
Output	Rated Output Capacity (kVA)	< 460 V *3	HD1	16	20	26	30	39	49	60	
			ND1	20	25	29	39	49	59	68	
		≥ 460 V *4	HD2	17	22	27	32	41	52	61	
			ND2	22	27	32	41	52	61	76	
	Rated Output Current (A)	< 460 V	HD1	24	31	39	45	60	75	91	
			ND1	31	38	44	59.6	74.9	89.2	103	
		≥ 460 V	HD2	21	27	34	40	52	65	77	
			ND2	27	34	40	52	65	77	96	
	Overload Tolerance			<ul style="list-style-type: none"> HD: 150% of the rated output current for 60 seconds. The permitted frequency of overload is one time each 10 minutes. ND: 110% of the rated output current for 60 seconds. The permitted frequency of overload is one time each 10 minutes. Note: Derating can be necessary for applications that start and stop frequently.							
	Carrier Frequency			HD: 8 kHz without derating the drive capacity. ND: 2 kHz without derating the drive capacity. Derate the drive capacity to use values to 15 kHz maximum.							
Maximum Output Voltage			Three-phase 380 V to 480 V Note: The maximum output voltage is proportional to the input voltage.								
Maximum Output Frequency			<ul style="list-style-type: none"> AOLV and EZOLV: 120 Hz CL-V/f, CLV, AOLV/PM, and CLV/PM: 400 Hz V/f, OLV, OLV/PM: 590 Hz 								
Measures for Harmonics	DC reactor		External options				Standard internal characteristics				
Braking Device	Braking Transistor		Standard internal characteristics								
EMC Filter	EMC Filter IEC 61800-3, C3		Factory option <ul style="list-style-type: none"> Models 4xxxB: There is a category C3 EMC filter in the drive. 								
Power Supply	Rated Voltage, Rated Frequency		<ul style="list-style-type: none"> Three-phase AC power supply 380 V to 480 V at 50/60 Hz DC power supply 513 V to 679 V 								
	Permitted Voltage Fluctuation		-15% to +10%								
	Permitted Frequency Fluctuation		±5%								
	Input Power (kVA)	< 460 V	HD1	24	33	40	34	46	57	69	
			ND1	33	40	48	46	57	69	84	
Input Power (kVA)	≥ 460 V	HD2	21	28	35	30	40	49	59		
		ND2	28	35	41	40	49	59	72		

- *1 The maximum applicable motor output complies with 380 V motor ratings as specified in Annex G of IEC 60947-4-1. The rated output current of the drive output amps must be equal to or more than the motor rated current.
- *2 The maximum applicable motor output complies with 460 V motor ratings as specified in NEC Table 430.250. The rated output current of the drive output amps must be equal to or more than the motor rated current.
- *3 The rated output capacity is calculated with a rated output voltage of 380 V.
- *4 The rated output capacity is calculated with a rated output voltage of 460 V.

Table 10.7 Rating (400 V Class)

Model		Input Voltage	Duty Rating	4140	4168	4208	4250	4296	4371	4389
Maximum Applicable Motor Output (kW)	< 460 V *1	HD1	55	75	90	110	132	160	200	
		ND1	75	90	110	132	160	200	220	
	≥ 460 V *2	HD2	55	75	90	110	150	185	220	
		ND2	75	90	110	150	185	220	260	
Maximum Applicable Motor Output (HP)	< 460 V *1	HD1	75	100	125	150	175	200	250	
		ND1	100	125	150	175	200	250	300	
	≥ 460 V *2	HD2	75	100	125	150	200	250	300	
		ND2	100	125	150	200	250	300	350	

10.4 Model-Specific Specifications (400 V Class)

Model		Input Voltage	Duty Rating	4140	4168	4208	4250	4296	4371	4389	
Input	Rated Input Current (A)	< 460 V	HD1 (AC)	105	142	170	207	248	300	373	
			HD1 (DC)	129	174	209	254	304	367	457	
			ND1 (AC)	142	170	207	248	300	373	410	
			ND1 (DC)	174	209	254	304	367	457	502	
		≥ 460 V	HD2 (AC)	86.9	118	141	171	232	289	346	
			HD2 (DC)	106.0	144	172	210	284	354	424	
			ND2 (AC)	118	141	171	232	289	346	403	
			ND2 (DC)	144	172	210	284	354	424	494	
Output	Rated Output Capacity (kVA)	< 460 V *3	HD1	74	99	118	142	171	200	244	
			ND1	92	111	137	165	195	244	256	
		≥ 460 V *4	HD2	76	99	124	143	191	241	288	
			ND2	99	124	143	191	241	288	330	
	Rated Output Current (A)	< 460 V	HD1	112	150	180	216	260	304	371	
			ND1	140	168	208	250	296	371	389	
		≥ 460 V	HD2	96	124	156	180	240	302	361	
			ND2	124	156	180	240	302	361	414	
	Overload Tolerance			<ul style="list-style-type: none"> HD: 150% of the rated output current for 60 seconds. The permitted frequency of overload is one time each 10 minutes. ND: 110% of the rated output current for 60 seconds. The permitted frequency of overload is one time each 10 minutes. <p>Note: Derating can be necessary for applications that start and stop frequently.</p>							
	Carrier Frequency			HD: 5 kHz without derating the drive capacity. ND: 2 kHz without derating the drive capacity. Derate the drive capacity to use values to 10 kHz maximum.							
	Maximum Output Voltage			Three-phase 380 V to 480 V Note: The maximum output voltage is proportional to the input voltage.							
	Maximum Output Frequency			<ul style="list-style-type: none"> AOLV and EZOLV: 120 Hz CL-V/f, CLV, AOLV/PM, and CLV/PM: 400 Hz V/f, OLV, OLV/PM: 590 Hz 							
	Measures for Harmonics	DC reactor		Standard internal characteristics							
	Braking Device	Braking Transistor		Standard internal characteristics				External options			
EMC Filter	EMC Filter IEC 61800-3, C3		Factory option <ul style="list-style-type: none"> Models 4xxxB: There is a category C3 EMC filter in the drive. 								
Power Supply	Rated Voltage, Rated Frequency		<ul style="list-style-type: none"> Three-phase AC power supply 380 V to 480 V at 50/60 Hz DC power supply 513 V to 679 V 								
	Permitted Voltage Fluctuation		-15% to +10%								
	Permitted Frequency Fluctuation		±5%								
	Input Power (kVA)	< 460 V	HD1	84	113	135	165	198	239	297	
			ND1	113	135	165	198	239	297	327	
≥ 460 V		HD2	72	98	117	142	193	240	288		
		ND2	98	117	142	193	295	288	335		

*1 The maximum applicable motor output complies with 380 V motor ratings as specified in Annex G of IEC 60947-4-1. The rated output current of the drive output amps must be equal to or more than the motor rated current.

*2 The maximum applicable motor output complies with 460 V motor ratings as specified in NEC Table 430.250. The rated output current of the drive output amps must be equal to or more than the motor rated current.

*3 The rated output capacity is calculated with a rated output voltage of 380 V.

*4 The rated output capacity is calculated with a rated output voltage of 460 V.

Table 10.8 Rating (400 V Class)

Model		Input Voltage	Duty Rating	4453	4568	4675	4810	4930	4H11	4H12	
Maximum Applicable Motor Output (kW)		< 460 V *1	HD1	220	250	315	400	450	500	560	
			ND1	250	315	355	450	500	560	630	
		≥ 460 V *2	HD2	260	300	335	450	525	600	675	
			ND2	300	335	370	525	600	675	750	
Maximum Applicable Motor Output (HP)		< 460 V *1	HD1	300	335	400	536	603	670	751	
			ND1	335	400	450	603	670	751	845	
		≥ 460 V *2	HD2	350	400	450	600	700	800	900	
			ND2	400	450	500	700	800	900	1000	
Input	Rated Input Current (A)	< 460 V	HD1 (AC)	410	465	584	783	830	976	1031	
			HD1 (DC)	502	569	715	959	1017	1195	1262	
			ND1 (AC)	465	584	657	879	922	1091	1158	
			ND1 (DC)	569	715	805	1077	1129	1337	1418	
		≥ 460 V	HD2 (AC)	403	460	516	726	799	965	1024	
			HD2 (DC)	494	563	632	890	978	1182	1255	
			ND2 (AC)	460	516	573	846	912	1085	1137	
			ND2 (DC)	563	632	702	1036	1117	1328	1392	
Output	Rated Output Capacity (kVA)	< 460 V *3	HD1	272	298	398	474	533	612	717	
			ND1	298	374	444	533	612	717	790	
		≥ 460 V *4	HD2	330	380	410	574	645	741	868	
			ND2	380	410	482	645	741	868	956	
	Rated Output Current (A)	< 460 V	HD1	414	453	605	720	810	930	1090	
			ND1	453	568	675	810	930	1090	1200	
		≥ 460 V	HD2	414	477	515	720	810	930	1090	
			ND2	477	515	605	810	930	1090	1200	
	Overload Tolerance	<ul style="list-style-type: none"> HD: 150% of the rated output current for 60 seconds. The permitted frequency of overload is one time each 10 minutes. ND: 110% of the rated output current for 60 seconds. The permitted frequency of overload is one time each 10 minutes. <p>Note: Derating can be necessary for applications that start and stop frequently.</p>									
		Carrier Frequency			HD: 2 kHz without derating the drive capacity. ND: 2 kHz without derating the drive capacity. Derate the drive capacity to use values to 5 kHz maximum.						
		Maximum Output Voltage			Three-phase 380 V to 480 V Note: The maximum output voltage is proportional to the input voltage.						
		Maximum Output Frequency			<ul style="list-style-type: none"> AOLV and EZOLV: 120 Hz CL-V/f, CLV, AOLV/PM, and CLV/PM: 400 Hz V/f, OLV, OLV/PM: 590 Hz 						
Measures for Harmonics	DC reactor		Standard internal characteristics								
Braking Device	Braking Transistor		External options								
EMC Filter	EMC Filter IEC 61800-3, C3		Factory option • Models 4xxxB: There is a category C3 EMC filter in the drive.				Factory option				

10.4 Model-Specific Specifications (400 V Class)

Model		Input Voltage	Duty Rating	4453	4568	4675	4810	4930	4H11	4H12
Power Supply	Rated Voltage, Rated Frequency		<ul style="list-style-type: none"> • Three-phase AC power supply 380 V to 480 V at 50/60 Hz • DC power supply 513 V to 679 V 							
	Permitted Voltage Fluctuation		-15% to +10%							
	Permitted Frequency Fluctuation		±5%							
	Input Power (kVA)	< 460 V	HD1	327	370	465	624	662	777	821
			ND1	370	465	523	701	734	870	923
Input Power (kVA)	≥ 460 V	HD2	335	382	429	604	664	803	852	
		ND2	382	429	476	703	758	902	945	

*1 The maximum applicable motor output complies with 380 V motor ratings as specified in Annex G of IEC 60947-4-1. The rated output current of the drive output amps must be equal to or more than the motor rated current.

*2 The maximum applicable motor output complies with 460 V motor ratings as specified in NEC Table 430.250. The rated output current of the drive output amps must be equal to or more than the motor rated current.

*3 The rated output capacity is calculated with a rated output voltage of 380 V.

*4 The rated output capacity is calculated with a rated output voltage of 460 V.

10.5 Drive Specifications

Note:

- To get the OLV, CLV, and AOLV specifications, do Rotational Auto-Tuning.
- To get the longest product life, install the drive in an environment that meets the necessary specifications.

Table 10.9 Control Characteristics

Item	Specification
Control Methods	<ul style="list-style-type: none"> • V/f Control • V/f Control with Encoder • Open Loop Vector • Closed Loop Vector • Advanced Open Loop Vector • PM Open Loop Vector • PM Advanced Open Loop Vector • PM Closed Loop Vector • EZ Vector Control
Frequency Control Range	<ul style="list-style-type: none"> • AOLV and EZOLV: 0.01 Hz to 120 Hz • CL-V/f, CLV, AOLV/PM, and CLV/PM: 0.01 Hz to 400 Hz • V/f, OLV, and OLV/PM: 0.01 Hz to 590 Hz
Frequency Accuracy (Temperature Fluctuation)	Digital inputs: $\pm 0.01\%$ of the maximum output frequency ($-10\text{ }^{\circ}\text{C}$ to $+40\text{ }^{\circ}\text{C}$ ($14\text{ }^{\circ}\text{F}$ to $104\text{ }^{\circ}\text{F}$)) Analog inputs: $\pm 0.1\%$ of the maximum output frequency ($25\text{ }^{\circ}\text{C} \pm 10\text{ }^{\circ}\text{C}$ ($77\text{ }^{\circ}\text{F} \pm 18\text{ }^{\circ}\text{F}$))
Frequency Setting Resolution	Digital inputs: 0.01 Hz Analog inputs: 1/2048 of the maximum output frequency (11-bit signed)
Output Frequency Resolution	0.001 Hz
Frequency Setting Signal	Main speed frequency reference: -10 Vdc to $+10\text{ Vdc}$ (20 k Ω), 0 Vdc to 10 Vdc (20 k Ω), 4 mA to 20 mA (250 Ω), 0 mA to 20 mA (250 Ω) Main speed reference: Pulse train input (maximum 32 kHz)
Starting Torque	<ul style="list-style-type: none"> • V/f: 150%/3 Hz • CL-V/f: 150%/3 Hz • OLV: 200%/0.3 Hz • CLV: 200%/0 min⁻¹ (r/min) • AOLV: 200%/0.3 Hz • OLV/PM: 100%/5% speed • AOLV/PM: 200%/0 min⁻¹ (r/min) • CLV/PM: 200%/0 min⁻¹ (r/min) • EZOLV: 100%/1% speed Note: <ul style="list-style-type: none"> • Correctly select the drive and motor capacity for this starting torque in these control methods: <ul style="list-style-type: none"> –OLV –CLV –AOLV –AOLV/PM –CLV/PM • Set $n8-57 = 1$ [HFI Overlap Selection = Enabled] for this starting torque in AOLV/PM. When you use a non-Yaskawa PM motor, do Rotational Auto-Tuning.
Speed Control Range	<ul style="list-style-type: none"> • V/f: 1:40 • CL-V/f: 1:40 • OLV: 1:200 • CLV: 1:1500 • AOLV: 1:200 • OLV/PM: 1:20 • AOLV/PM: 1:100 • CLV/PM: 1:1500 • EZOLV: 1:100 Note: <ul style="list-style-type: none"> • Set $n8-57 = 1$ [HFI Overlap Selection = Enabled] for this Speed Control Range in AOLV/PM. When you use a non-Yaskawa PM motor, do Rotational Auto-Tuning. • Speed control range of 1:100 for AOLV/PM is Instantaneous operation range. Correctly select the drive and motor capacity for continuous operation.
Zero Speed Control	Possible in these control methods: <ul style="list-style-type: none"> • CLV • AOLV/PM • CLV/PM

10.5 Drive Specifications

Item	Specification
Torque Limits	You can use parameter settings for different limits in four quadrants in these control methods: <ul style="list-style-type: none"> • OLV • CLV • AOLV • AOLV/PM • CLV/PM • EZOLV
Acceleration and Deceleration Times	0.0 s to 6000.0 s The drive can set four pairs of different acceleration and deceleration times.
Braking Torque	Approximately 20% Approximately 125% with a dynamic braking option <ul style="list-style-type: none"> • Short-time average deceleration torque Motor output 0.4/0.75 kW: over 100% Motor output 1.5 kW: over 50% Motor output 2.2 kW and larger: over 20%. Overexcitation Braking/High Slip Braking allow for approximately 40% • Continuous regenerative torque: Approximately 20%. Dynamic braking option allows for approximately 125%, 10%ED, 10 s <p>WARNING! Set L3-04 = 0 [Stall Prevention during Decel = Disabled] when you operate the drive with:</p> <ul style="list-style-type: none"> • a regenerative converter • regenerative unit • braking unit • braking resistor • braking resistor unit. <p>If you set the parameter incorrectly, the drive can decelerate for too long and cause serious injury or death.</p> <p>Note:</p> <ul style="list-style-type: none"> • Models 2004 to 2138 and 4002 to 4168 have a braking transistor. • Short-time average deceleration torque refers to the necessary torque to decelerate the motor (uncoupled from the load) from the rated speed to zero. Motor characteristics can change the actual specifications. • Motor characteristics change the continuous regenerative torque and short-time average deceleration torque for motors 2.2 kW and larger.
V/f Characteristics	Select from 15 pre-defined V/f patterns, or a user-set V/f pattern.
Main Control Functions	Torque Control, Droop Control, Speed/Torque Control Switching, Feed Forward Control, Zero Servo Function, Restart After Momentary Power Loss, Speed Search, Overtorque/Undertorque Detection, Torque Limit, 17-Step Speed (max.), Accel/Decel Switch, S-curve Acceleration/Deceleration, 3-wire Sequence, Auto-Tuning (Rotational and Stationary), Dwell Function, Cooling Fan ON/OFF Switch, Slip Compensation, Torque Compensation, Frequency Jump, Upper/Lower Limits for Frequency Reference, DC Injection Braking at Start and Stop, Overexcitation Braking, High Slip Braking, PID Control (with Sleep Function), Energy Saving Control, MEMOBUS/Modbus Communication (RS-485 max, 115.2 kbps), Auto Restart, Application Presets, DriveWorksEZ (customized functions), Removable Terminal Block with Parameter Backup Function, Online Tuning, KEB, Overexcitation Deceleration, Inertia (ASR) Tuning, Overvoltage Suppression, High Frequency Injection

Table 10.10 Protection Functions

Item	Specification
Motor Protection	Electronic thermal overload protection
Momentary Overcurrent Protection	Drive stops when the output current is more than 200% of the HD output current.
Overload Protection	Drive stops when the output current is more than these overload tolerances: <ul style="list-style-type: none"> • HD: 150% of the rated output current for 60 seconds The permitted frequency of overload is one time each 10 minutes. • ND: 110% of the rated output current for 60 seconds The permitted frequency of overload is one time each 10 minutes. <p>Note: If output frequency < 6 Hz, the drive can trigger the overload protection function when the output current is in the overload tolerance range.</p>
Overvoltage Protection	200 V Class: Stops when the DC bus voltage is more than approximately 410 V 400 V Class: Stops when the DC bus voltage is more than approximately 820 V
Undervoltage Protection	200 V Class: Stops when the DC bus voltage decreases to less than approximately 190 V 400 V Class: Stops when the DC bus voltage decreases to less than approximately 380 V
Momentary Power Loss Ride-thru	Stops when power loss is longer than 15 ms. Continues operation if power loss is shorter than 2 s (depending on parameter settings). <p>Note:</p> <ul style="list-style-type: none"> • The stop time can be shorter depending on the load and motor speed. • Drive capacity will change the continuous operation time. A Momentary Power Loss Recovery Unit is necessary to continue operation through a 2 s power loss on models 2004 to 2056 and 4002 to 4031.
Heatsink Overheat Protection	The drive stops when the thermistor detects an IGBT temperature more than approximately 100°C (212°F). The trip temperature level is different for different drive models.
Braking Resistor Overheat Protection	Overheat detection for braking resistor (optional ERF-type, 3% ED)
Stall Prevention	Stall prevention is available during acceleration, deceleration, and during run.

Item	Specification
Ground Fault Protection	Electronic circuit protection Note: This protection detects ground faults during run. The drive will not provide protection when: <ul style="list-style-type: none"> • There is a low-resistance ground fault for the motor cable or terminal block • You energize the drive when there is a ground fault.
DC Bus Charge LED	Charge LED illuminates when DC bus voltage is more than 50 V.

Table 10.11 Environment

Item	Specification
Area of Use	Indoors
Power Supply	Overvoltage Category III
Surrounding Air Temperature	IP00/UL Open Type: -10 °C to +50 °C (14 °F to 122 °F) IP20/UL Open Type: -10 °C to +50 °C (14 °F to 122 °F) IP20/UL Type 1: -10 °C to +40 °C (14 °F to 104 °F) <ul style="list-style-type: none"> • When you install the drive in an enclosure, use a cooling fan or air conditioner to keep the internal air temperature in the permitted range. • Do not let the drive freeze. • You can use IP00/IP20/UL Open Type drives at a maximum of 60 °C (140 °F) when you derate the output current. • You can use IP20/UL Type 1 drives at a maximum of 50 °C (122 °F) when you derate the output current.
Humidity	95% RH or less Do not let condensation form on the drive.
Storage Temperature	-20 °C to +70 °C (-4 °F to +158 °F) (short-term temperature during transportation)
Surrounding Area	Pollution degree 2 or less Install the drive in an area without: <ul style="list-style-type: none"> • Oil mist, corrosive or flammable gas, or dust • Metal powder, oil, water, or other unwanted materials • Radioactive materials or flammable materials, including wood • Harmful gas or fluids • Salt • Direct sunlight
Altitude	1000 m (3281 ft) Maximum Note: Derate the output current by 1% for each 100 m (328 ft) to install the drive in altitudes between 1000 m to 4000 m (3281 ft to 13123 ft). It is not necessary to derate the rated voltage in these conditions: <ul style="list-style-type: none"> • Installing the drive at 2000 m (6562 ft) or lower • Installing the drive between 2000 m to 4000 m (6562 ft to 13123 ft) and grounding the neutral point on the power supply. Contact Yaskawa or your nearest sales representative if you will not ground the neutral point.
Vibration ^{*1}	<ul style="list-style-type: none"> • 10 Hz to 20 Hz: 2004 to 2415, 4002 to 4675: 1 G (9.8 m/s², 32.15 ft/s²) 4810 to 4H12: 0.6 G (5.9 m/s², 19.36 ft/s²) • 20 Hz to 55 Hz: 2004 to 2211, 4002 to 4168: 0.6 G (5.9 m/s², 19.36 ft/s²) 2257 to 2415, 4208 to 4H12: 0.2 G (2.0 m/s², 6.56 ft/s²)
Installation Orientation	Install the drive vertically for sufficient airflow to cool the drive.

*1 This drive passed the vibration test with a logarithmic sweep as specified by EN 60068-2-6 and JIS C60068-2-6. If the internal components of the drive vibrate too much, it can cause damage to the drive even when the vibration frequency is in the specification. If the drive components vibrate, improve the installation environment to decrease vibration. To improve the installation environment for vibration, you can put the motor on a rubber pad or reinforce the structure of the installation.

Table 10.12 Standard

Item	Specification
Applicable Standards	<ul style="list-style-type: none"> • UL 61800-5-1 • EN 61800-3 • IEC/EN 61800-5-1 • Two Safe Disable inputs and one EDM output according to EN ISO 13849-1:2015 (PL e (Cat.III)), IEC/EN 61508 SIL3
Enclosure Protection Design	IP00/UL Open Type IP20/UL Open Type IP20/UL Type 1 Note: To change an IP20/UL Open Type drive to an IP20/UL Type 1 drive, install a UL Type 1 kit.

10.6 Drive Derating

You must derate the drive capacity to operate the drive above the rated temperature, altitude, and default carrier frequency.

◆ Carrier Frequency Settings and Rated Current Values

Table 10.13 and Table 10.16 show how the drive rated output current changes when the C6-02 [Carrier Frequency Selection] value changes.

The output current value changes linearly as the carrier frequency changes. You can use the values from the tables to calculate a frequency that is not shown. When A1-02 = 4 [Control Method Selection = AOLV], refer to Table 10.14 and Table 10.17.

When A1-02 = 6 [AOLV/PM], refer to Table 10.15 and Table 10.18.

Note:

The drive only applies the carrier frequency derating of the output current to the reference output current value of oL2 [Drive Overload]. The drive will not derate the 100% output rated current of parameters and monitors as specified in the output rated current shown in Model-Specific Specifications (200 V Class) on page 458 and Model-Specific Specifications (400 V Class) on page 461.

■ 200 V Class

Table 10.13 Carrier Frequency and Rated Current Derating When A1-02 = 0, 1, 2, 3, 5, 7, 8

Model	Rated Current (A)											
	Heavy Duty Rating (HD1)						Normal Duty Rating (ND1)					
	2 kHz	5 kHz	8 kHz	10 kHz	12.5 kHz	15 kHz	2 kHz	5 kHz	8 kHz	10 kHz	12.5 kHz	15 kHz
2004	3.2	3.2	3.2	3.1	2.9	2.78	3.5	3.3	2.9	2.7	2.4	2.1
2006	5.0	5.0	5.0	4.8	4.6	4.3	6.0	5.6	5.0	4.6	4.1	3.6
2010	8.0	8.0	8.0	7.4	6.6	5.8	9.6	9.0	8.0	7.4	6.6	5.8
2012	11.0	11.0	11.0	10.4	9.6	8.8	12.0	11.7	11.0	10.5	9.9	9.3
2018	14.0	14.0	14.0	12.6	10.8	9.1	17.5	16.1	14.0	12.6	10.8	9.1
2021	17.5	17.5	17.5	16.1	14.3	12.6	21.0	19.6	17.0	16.1	14.3	12.5
2030	25.0	25.0	25.0	23.0	20.5	18.0	30.0	28.0	25.0	23.0	20.5	18.0
2042	33.0	33.0	33.0	29.3	24.8	20.2	42.0	38.4	33.0	29.4	24.9	20.4
2056	47.0	47.0	47.0	43.4	38.9	34.4	56.0	52.4	47.0	43.4	38.9	34.4
2070	60.0	60.0	60.0	56.0	51.0	46.0	70.0	66.0	60.0	56.0	51.0	46.0
2082	75.0	75.0	75.0	68.6	60.5	53.0	82.0	82.0	75.0	68.8	61.0	53.1
2110	88.0	88.0	88.0	80.5	71.0	62.0	110.0	102.7	92.0	84.3	75.2	66.0
2138	115.0	115.0	115.0	105.1	92.8	81.0	138.0	128.8	115.0	105.8	94.3	82.8
2169	145.0	145.0	125.2	112.0	-	-	169.0	152.7	128.3	112.0	-	-
2211	180.0	180.0	155.2	138.6	-	-	211.0	190.2	158.9	138.1	-	-
2257	215.0	215.0	184.8	164.7	-	-	257.0	230.4	190.5	163.9	-	-
2313	283.0	283.0	249.0	226.4	-	-	313.0	288.5	251.7	227.1	-	-
2360	346.0	346.0	294.3	259.8	-	-	360.0	330.8	287.6	258.8	-	-
2415	415.0	415.0	365.2	332.0	-	-	415.0	391.3	355.7	332.0	-	-

Table 10.14 Carrier Frequency and Rated Current Derating When A1-02 = 4 [AOLV]

Model	Rated Current (A)									
	Heavy Duty Rating (HD1)					Normal Duty Rating (ND1)				
	2 kHz	5 kHz	8 kHz	10 kHz	12.5 kHz	2 kHz	5 kHz	8 kHz	10 kHz	12.5 kHz
2004	3.2	3.2	3.0	2.8	2.6	3.5	3.0	2.4	2.1	1.7
2006	5.0	5.0	4.6	4.3	4.0	6.0	5.1	4.0	3.6	2.8
2010	8.0	8.0	6.7	5.8	4.5	9.6	8.2	7.0	5.8	4.6
2012	11.0	11.0	9.8	8.8	7.7	12.0	11.1	10.0	9.3	8.4

Model	Rated Current (A)									
	Heavy Duty Rating (HD1)					Normal Duty Rating (ND1)				
	2 kHz	5 kHz	8 kHz	10 kHz	12.5 kHz	2 kHz	5 kHz	8 kHz	10 kHz	12.5 kHz
2018	14.0	14.0	11.2	9.1	6.4	17.5	14.3	11.0	9.1	6.4
2021	17.5	17.5	14.7	12.6	9.9	21.0	17.8	15.0	12.5	9.9
2030	25.0	25.0	21.0	18.0	14.3	30.0	25.5	21.0	18.0	14.3
2042	33.0	33.0	25.7	20.2	13.3	42.0	33.9	26.0	20.4	13.7
2056	47.0	47.0	39.8	34.4	27.7	56.0	47.9	40.0	34.4	27.6
2070	60.0	60.0	52.0	46.0	38.5	70.0	61.0	52.0	46.0	38.5
2082	75.0	75.0	62.1	52.5	40.4	82.0	76.7	63.0	53.1	41.4
2110	88.0	88.0	72.9	61.6	47.5	110.0	93.5	77.0	66.0	52.3
2138	115.0	115.0	95.3	80.5	62.0	138.0	117.3	97.0	82.8	65.6
2169	145.0	128.5	98.8	78.9	-	169.0	132.3	95.7	71.2	-
2211	180.0	159.3	122.0	97.2	-	211.0	164.1	117.2	86.0	-
2257	215.0	189.8	144.5	114.3	-	257.0	197.2	137.3	97.4	-
2313	283.0	254.7	203.8	169.8	-	313.0	257.8	202.6	165.8	-
2360	346.0	302.9	225.3	173.6	-	360.0	294.8	230.0	186.8	-
2415	415.0	373.5	298.8	249.0	-	415.0	361.6	308.3	272.7	-

Table 10.15 Carrier Frequency and Rated Current Derating When A1-02 = 6 [AOLV/PM]

Model	Rated Current (A)											
	Heavy Duty Rating (HD1)						Normal Duty Rating (ND1)					
	2 kHz	4 kHz	6 kHz	8 kHz	10 kHz	12 kHz	2 kHz	4 kHz	6 kHz	8 kHz	10 kHz	12 kHz
2004	3.2	3.2	3.1	3.0	2.8	2.6	3.5	3.1	2.8	2.4	2.1	1.7
2006	5.0	5.0	4.9	4.6	4.3	4.1	6.0	5.4	4.8	4.2	3.6	3.0
2010	8.0	8.0	7.7	6.7	5.8	4.8	9.6	8.6	7.7	6.7	5.8	4.8
2012	11.0	11.0	10.7	9.8	8.8	7.9	12.2	11.5	10.7	10.0	9.3	8.6
2018	14.0	14.0	13.3	11.2	9.1	6.9	17.5	15.4	13.3	11.2	9.1	6.9
2021	17.5	17.5	16.8	14.7	12.6	10.4	21.0	18.9	16.8	14.6	12.5	10.4
2030	25.0	25.0	24.0	21.0	18.0	15.0	30.0	27.0	24.0	21.0	18.0	15.0
2042	33.0	33.0	31.2	25.7	20.2	14.7	42.0	36.6	31.2	25.8	20.4	15.0
2056	47.0	47.0	45.2	39.8	34.4	29.0	56.0	50.6	45.2	39.8	34.4	29.0
2070	60.0	60.0	58.0	52.0	46.0	40.0	70.0	64.0	58.0	52.0	46.0	40.0
2082	75.0	75.0	71.8	62.1	52.5	42.9	82.0	81.4	72.0	62.6	53.1	43.7
2110	88.0	88.0	84.2	72.9	61.6	50.3	110.0	99.0	88.0	77.0	66.0	55.0
2138	115.0	115.0	110.1	95.3	80.5	65.7	138.0	124.2	110.4	96.6	82.8	69.0
2169	145.0	138.4	118.6	98.8	78.9	-	169.0	144.6	120.1	95.7	71.2	-
2211	180.0	171.7	146.9	122.0	97.2	-	211.0	179.7	148.5	117.2	86.0	-
2257	215.0	204.9	174.7	144.5	114.3	-	257.0	217.1	177.2	137.3	97.4	-
2313	283.0	271.7	237.7	203.8	169.8	-	313.0	276.2	239.4	202.6	165.8	-
2360	346.0	328.8	277.0	225.3	173.6	-	359.6	316.4	273.2	230.0	186.8	-
2415	415.0	398.4	348.6	298.8	249.0	-	415.0	379.4	343.9	308.3	272.7	-

■ 400 V Class

Table 10.16 Carrier Frequency and Rated Current Derating When A1-02 = 0, 1, 2, 3, 5, 7, 8 (< 460 V)

Model	Rated Current (A)											
	Heavy Duty Rating (HD1)						Normal Duty Rating (ND1)					
	2 kHz	5 kHz	8 kHz	10 kHz	12.5 kHz	15 kHz	2 kHz	5 kHz	8 kHz	10 kHz	12.5 kHz	15 kHz
4002	1.8	1.8	1.8	1.6	1.3	1.0	2.1	2.0	1.8	1.7	1.5	1.4
4004	3.4	3.4	3.4	2.9	2.3	1.7	4.1	3.8	3.4	3.1	2.8	2.4
4005	4.8	4.8	4.8	4.3	3.7	3.0	5.4	5.2	4.8	4.6	4.3	3.9
4007	5.5	5.5	5.5	4.9	4.1	3.2	7.1	6.5	5.5	4.8	4.0	3.2
4009	7.2	7.2	7.2	6.5	5.6	4.8	8.9	8.2	7.2	6.5	5.6	4.8
4012	9.2	9.2	9.2	8.1	6.8	5.4	11.9	10.8	9.2	8.1	6.7	5.4
4018	14.8	14.8	14.8	13.1	11.0	8.9	17.5	17.3	14.8	13.1	11.0	8.9
4023	18.0	18.0	18.0	15.9	13.4	10.8	23.0	21.5	18.3	16.2	13.6	11.0
4031	24.0	24.0	24.0	21.2	17.7	14.1	31.0	28.2	24.0	21.1	17.6	14.1
4038	31.0	31.0	31.0	27.5	23.0	18.6	38.0	36.3	31.0	27.5	23.0	18.6
4044	39.0	39.0	39.0	34.5	29.0	23.4	44.0	43.6	37.5	33.5	28.4	23.4
4060	45.0	45.0	45.0	39.1	31.8	24.4	60.0	53.7	44.9	39.1	31.7	24.0
4075	60.0	60.0	60.0	53.1	44.6	36.0	75.0	73.8	62.9	55.6	46.5	37.0
4089	75.0	75.0	75.0	66.4	55.7	45.0	89.0	88.8	75.8	67.2	56.4	46.0
4103	91.0	91.0	91.0	80.6	67.6	54.6	103.0	103.0	90.3	80.1	67.3	55.0
4140	112.0	112.0	91.8	78.4	-	-	140.0	122.8	96.7	79.0	-	-
4168	150.0	150.0	123.0	105.0	-	-	168.0	150.5	124.4	107.0	-	-
4208	180.0	180.0	147.6	126.0	-	-	208.0	179.7	137.2	109.0	-	-
4250	216.0	216.0	177.1	151.2	-	-	250.0	221.8	179.4	151.0	-	-
4296	260.0	260.0	213.2	182.0	-	-	296.0	263.4	214.6	182.0	-	-
4371	304.0	304.0	249.3	212.8	-	-	371.0	327.2	261.6	218.0	-	-
4389	371.0	371.0	304.2	259.7	-	-	389.0	348.0	286.3	245.0	-	-
4453	414.0	345.7	-	-	-	-	453.0	349.0	-	-	-	-
4568	453.0	378.3	-	-	-	-	568.0	437.0	-	-	-	-
4675	605.0	505.2	-	-	-	-	675.0	529.0	-	-	-	-
4810	720.0	600.0	-	-	-	-	810.0	624.0	-	-	-	-
4930	810.0	675.0	-	-	-	-	930.0	716.0	-	-	-	-
4H11	930.0	775.0	-	-	-	-	1090.0	852.0	-	-	-	-
4H12	1090.0	908.0	-	-	-	-	1200.0	938.0	-	-	-	-

Table 10.17 Carrier Frequency and Rated Current Derating When A1-02 = 4 [AOLV] (< 460 V)

Model	Rated Current (A)									
	Heavy Duty Rating (HD1)					Normal Duty Rating (ND1)				
	2 kHz	5 kHz	8 kHz	10 kHz	12.5 kHz	2 kHz	5 kHz	8 kHz	10 kHz	12.5 kHz
4002	1.8	1.8	1.3	1.0	0.6	2.1	1.8	1.6	1.4	1.2
4004	3.4	3.4	2.4	1.7	0.8	4.1	3.5	2.8	2.4	1.9
4005	4.8	4.8	3.8	3.0	2.1	5.4	4.9	4.3	3.9	3.5
4007	5.5	5.5	4.2	3.2	2.0	7.1	5.7	4.2	3.2	2.0
4009	7.2	7.2	5.8	4.8	3.5	8.9	7.4	5.8	4.8	3.5
4012	9.2	9.2	7.0	5.4	3.3	11.9	9.5	7.0	5.4	3.3
4018	14.8	14.8	11.4	8.9	5.7	17.5	15.2	11.4	8.9	5.7
4023	18.0	18.0	13.9	10.8	6.9	23.0	18.8	14.1	11.0	7.1
4031	24.0	24.0	18.4	14.1	8.8	31.0	24.7	18.3	14.1	8.8

Model	Rated Current (A)									
	Heavy Duty Rating (HD1)					Normal Duty Rating (ND1)				
	2 kHz	5 kHz	8 kHz	10 kHz	12.5 kHz	2 kHz	5 kHz	8 kHz	10 kHz	12.5 kHz
4038	31.0	31.0	23.9	18.6	12.0	38.0	31.9	23.9	18.6	12.0
4044	39.0	39.0	30.1	23.4	15.0	44.0	38.5	29.5	23.4	15.8
4060	45.0	45.0	33.3	24.4	13.4	60.0	46.4	33.2	24.4	13.4
4075	60.0	60.0	46.3	36.0	23.1	75.0	64.7	48.4	37.5	23.8
4089	75.0	75.0	57.9	45.0	28.9	89.0	78.0	58.6	45.6	29.4
4103	91.0	91.0	70.2	54.6	35.1	103.0	92.8	69.9	54.6	35.5
4140	112.0	95.2	65.0	44.8	-	140.0	101.1	62.0	36.0	-
4168	150.0	127.5	87.0	60.0	-	168.0	128.7	89.5	63.0	-
4208	180.0	153.0	104.4	72.0	-	208.0	144.3	80.6	38.0	-
4250	216.0	183.6	125.3	86.4	-	250.0	186.5	123.0	81.0	-
4296	260.0	221.0	150.8	104.0	-	296.0	222.7	149.4	101.0	-
4371	304.0	258.4	176.3	121.6	-	371.0	272.5	174.0	108.0	-
4389	371.0	315.4	215.2	148.4	-	389.0	297.0	203.8	142.0	-
4453	414.0	259.8	-	-	-	453.0	219.0	-	-	-
4568	453.0	284.3	-	-	-	568.0	274.0	-	-	-
4675	605.0	379.6	-	-	-	675.0	345.0	-	-	-
4810	720.0	450.0	-	-	-	810.0	391.0	-	-	-
4930	810.0	506.0	-	-	-	930.0	449.0	-	-	-
4H11	930.0	581.0	-	-	-	1090.0	554.0	-	-	-
4H12	1090.0	681.0	-	-	-	1200.0	610.0	-	-	-

Table 10.18 Carrier Frequency and Rated Current Derating When A1-02 = 6 [AOLV/PM] (< 460 V)

Model	Rated Current (A)											
	Heavy Duty Rating (HD1)						Normal Duty Rating (ND1)					
	2 kHz	4 kHz	6 kHz	8 kHz	10 kHz	12 kHz	2 kHz	4 kHz	6 kHz	8 kHz	10 kHz	12 kHz
4002	1.8	1.8	1.7	1.3	1.0	0.6	2.1	1.9	1.7	1.6	1.4	1.2
4004	3.4	3.4	3.2	2.4	1.7	1.0	4.1	3.7	3.3	2.8	2.4	2.0
4005	4.8	4.8	4.5	3.8	3.0	2.3	5.4	5.0	4.7	4.3	3.9	3.6
4007	5.5	5.5	5.2	4.2	3.2	2.3	7.1	6.1	5.2	4.2	3.2	2.3
4009	7.2	7.2	6.9	5.8	4.8	3.8	8.9	7.9	6.8	5.8	4.8	3.7
4012	9.2	9.2	8.7	7.0	5.4	3.8	11.9	10.3	8.6	7.0	5.4	3.8
4018	14.8	14.8	14.0	11.4	8.9	6.3	17.5	16.5	14.0	11.4	8.9	6.3
4023	18.0	18.0	17.0	13.9	10.8	7.7	23.4	20.4	17.3	14.1	11.0	7.8
4031	24.0	24.0	22.6	18.4	14.1	9.9	31.0	26.8	22.6	18.3	14.1	9.9
4038	31.0	31.0	29.2	23.9	18.6	13.3	38.0	34.5	29.2	23.9	18.6	13.3
4044	39.0	39.0	36.8	30.1	23.4	16.7	44.0	41.6	35.5	29.5	23.4	17.3
4060	45.0	45.0	42.1	33.3	24.4	15.6	59.6	50.8	42.0	33.2	24.4	15.6
4075	60.0	60.0	56.6	46.3	36.0	25.7	74.9	70.2	59.3	48.4	37.5	26.5
4089	75.0	75.0	70.7	57.9	45.0	32.1	89.2	84.5	71.5	58.6	45.6	32.7
4103	91.0	91.0	85.8	70.2	54.6	39.0	103.0	100.5	85.2	69.9	54.6	39.3
4140	112.0	105.3	85.1	65.0	44.8	-	140.0	114.1	88.1	62.0	36.0	-
4168	150.0	141.0	114.0	87.0	60.0	-	168.0	141.8	115.6	89.5	63.3	-
4208	180.0	169.2	136.8	104.4	72.0	-	208.0	165.5	123.1	80.6	38.1	-
4250	216.0	203.0	164.2	125.3	86.4	-	250.0	207.7	165.3	123.0	80.6	-
4296	260.0	244.4	197.6	150.8	104.0	-	296.0	247.1	198.3	149.4	100.6	-

Model	Rated Current (A)											
	Heavy Duty Rating (HD1)						Normal Duty Rating (ND1)					
	2 kHz	4 kHz	6 kHz	8 kHz	10 kHz	12 kHz	2 kHz	4 kHz	6 kHz	8 kHz	10 kHz	12 kHz
4371	304.0	285.8	231.0	176.3	121.6	-	371.0	305.3	239.7	174.0	108.3	-
4389	371.0	348.7	282.0	215.2	148.4	-	389.0	327.5	265.7	203.8	142.0	-
4453	414.0	311.3	-	-	-	-	453.0	296.7	-	-	-	-
4568	453.0	340.7	-	-	-	-	568.0	372.0	-	-	-	-
4675	605.0	455.0	-	-	-	-	675.0	455.0	-	-	-	-
4810	720.0	540.0	-	-	-	-	810.0	531.0	-	-	-	-
4930	810.0	607.0	-	-	-	-	930.0	609.0	-	-	-	-
4H11	930.0	697.0	-	-	-	-	1090.0	733.0	-	-	-	-
4H12	1090.0	817.0	-	-	-	-	1200.0	807.0	-	-	-	-

◆ Derating Depending on Ambient Temperature

When you install drives in a place where ambient temperatures are higher than the rated conditions or install drives side-by-side in the enclosure panel, set L8-12 [Ambient Temperature Setting] and L8-35 [Installation Method Selection]. Derate the output current as specified in Figure 10.1.

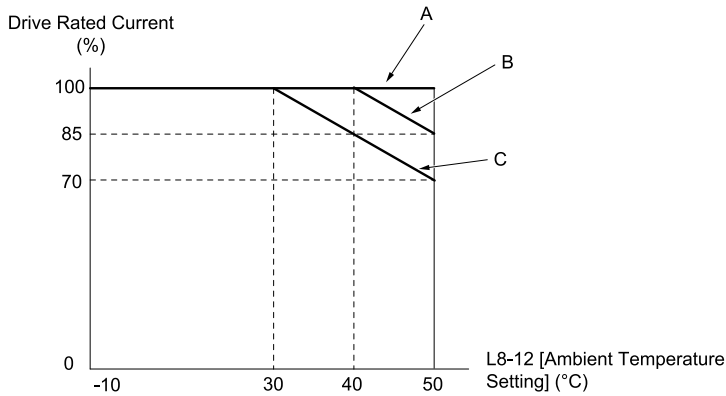

A - L8-35 = 0
 B - L8-35 = 2, L8-35 = 3

C - L8-35 = 1

Figure 10.1 Derating Depending on Drive Installation Method

■ L8-12: Ambient Temperature Setting

No. (Hex.)	Name	Description	Default (Range)
L8-12 (04B8)	Ambient Temperature Setting	<input type="checkbox"/> V/f <input type="checkbox"/> CL-V/f <input type="checkbox"/> OLV <input type="checkbox"/> CLV <input type="checkbox"/> AOLV <input type="checkbox"/> OLV/IPM <input type="checkbox"/> AOLV/IPM <input type="checkbox"/> CLV/IPM <input type="checkbox"/> EZOLV Sets the ambient temperature of the drive installation area.	40 °C (-10 °C - +50 °C)

The drive automatically adjusts the drive rated current to the best value as specified by the set temperature. Set the ambient temperature of the area where you install the drive to a value that is more than the drive rating.

Refer to [Derating Depending on Ambient Temperature on page 474](#) for information about derating depending on ambient temperature.

■ L8-35: Installation Method Selection

No. (Hex.)	Name	Description	Default (Range)
L8-35 (04EC)	Installation Method Selection	<input type="checkbox"/> V/f <input type="checkbox"/> CL-V/f <input type="checkbox"/> OLV <input type="checkbox"/> CLV <input type="checkbox"/> AOLV <input type="checkbox"/> OLV/IPM <input type="checkbox"/> AOLV/IPM <input type="checkbox"/> CLV/IPM <input type="checkbox"/> EZOLV Sets the type of drive installation.	Determined by the drive (0 - 3)

Note:

- Parameter A1-03 [Initialize Parameters] does not initialize this parameter.
- This parameter is set to the correct value when the drive is shipped. Side-by-Side installation
 - Change the value only in these conditions:
 - When you install a UL Type 1 kit on an IP20/UL Open Type drive to convert the drive to an IP20/UL Type 1 drive.

The drive automatically adjusts the overload protection detection level to the best value for each setting value. Refer to *Derating Depending on Ambient Temperature on page 474* for information about derating as specified by ambient temperature.

0 : IP00/IP20/UL Open Type/Ex Heatsink

Use this setting to install IP00/IP20/UL Open Type drives or when the heatsink (cooling fin) is outside the enclosure panel.

Make sure that there is 30 mm (1.18 in) minimum of space between drives or between the drive and side of the enclosure panel.

1 : Side-by-Side Mounting

Use this setting to install more than one drive side-by-side.

Make sure that there is 2 mm (0.08 in) minimum of space between drives.

2 : IP20/UL Type 1

Use this setting to install IP20/UL Type 1 drives.

3 : Finless

Use this setting to install a finless drive.

◆ Altitude Derating

Install the drive in a location that has an altitude of 1000 m (3281 ft) or lower.

Derate the output current by 1% for each 100 m (328 ft) to install the drive in altitudes between 1000 to 4000 m (3281 to 13123 ft).

It is not necessary to derate the rated voltage in these conditions:

- Installing the drive at 2000 m (6562 ft) or lower
- Installing the drive between 2000 to 4000 m (6562 to 13123 ft) and grounding the neutral point on the power supply.
If you do not ground the drive with a neutral network, contact Yaskawa or your nearest sales representative.

10.7 Drive Exterior and Mounting Dimensions

◆ Drive Models and Exterior and Mounting Dimensions

Note:

The estimated weights in this document are for drives with hardware revision D or later. For estimated weights of drives with hardware revision C or earlier, contact Yaskawa or your nearest sales representative. The "REV" column on the nameplate on the right side of the drive identifies the hardware revision. Refer to [Nameplate on page 23](#) for more information.

Table 10.19 Three-Phase 200 V Class

Model	Ref.	
	IP20/UL Open Type	IP20/UL Type 1
2004 - 2042	477	487
2056	478	488
2070, 2082	479	489
2110	480	490
2138	481	491
2169, 2211	482	492
2257, 2313	483	493
2360	484	494
2415	484	-

Table 10.20 Three-Phase 400 V Class

Model	Ref.		
	IP00/UL Open Type	IP20/UL Open Type	IP20/UL Type 1
4002 - 4023	-	477	487
4031, 4038	-	478	488
4044 - 4060	-	479	489
4075	-	480	490
4089, 4103	-	481	491
4140, 4168	-	482	492
4208 - 4296	-	483	493
4371	-	484	494
4389	-	484	-
4453 - 4675	-	485	-
4810 - 4H12	486	-	-

◆ IP00/IP20/UL Open Type

■ 2004 - 2042, 4002 - 4023

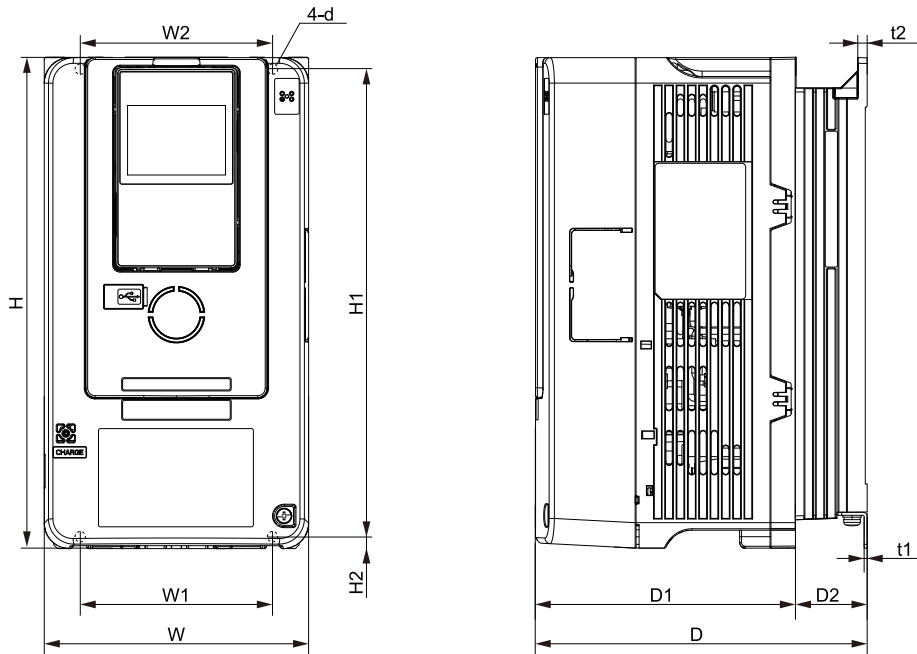

Figure 10.2 Dimension Diagram 1

Table 10.21 Three-Phase 200 V Class (IP20/UL Open Type)

Model	Dimensions mm (in)											Est. Weight kg (lb)	
	W	H	D	D1	D2	W1	W2	H1	H2	t1	t2		d
2004	140 (5.51)	260 (10.24)	176 (6.93)	138 (5.43)	38 (1.50)	102 (4.02)	102 (4.02)	248 (9.76)	6 (0.24)	1.6 (0.06)	5 (0.20)	M5	3.5 (7.72)
2006	140 (5.51)	260 (10.24)	176 (6.93)	138 (5.43)	38 (1.50)	102 (4.02)	102 (4.02)	248 (9.76)	6 (0.24)	1.6 (0.06)	5 (0.20)	M5	3.5 (7.72)
2010	140 (5.51)	260 (10.24)	176 (6.93)	138 (5.43)	38 (1.50)	102 (4.02)	102 (4.02)	248 (9.76)	6 (0.24)	1.6 (0.06)	5 (0.20)	M5	3.5 (7.72)
2012	140 (5.51)	260 (10.24)	176 (6.93)	138 (5.43)	38 (1.50)	102 (4.02)	102 (4.02)	248 (9.76)	6 (0.24)	1.6 (0.06)	5 (0.20)	M5	3.5 (7.72)
2018	140 (5.51)	260 (10.24)	211 (8.31)	138 (5.43)	73 (2.87)	102 (4.02)	102 (4.02)	248 (9.76)	6 (0.24)	1.6 (0.06)	5 (0.20)	M5	3.8 (8.38)
2021	140 (5.51)	260 (10.24)	211 (8.31)	138 (5.43)	73 (2.87)	102 (4.02)	102 (4.02)	248 (9.76)	6 (0.24)	1.6 (0.06)	5 (0.20)	M5	3.8 (8.38)
2030	140 (5.51)	260 (10.24)	211 (8.31)	138 (5.43)	73 (2.87)	102 (4.02)	102 (4.02)	248 (9.76)	6 (0.24)	1.6 (0.06)	5 (0.20)	M5	4.2 (9.26)
2042	140 (5.51)	260 (10.24)	211 (8.31)	138 (5.43)	73 (2.87)	102 (4.02)	102 (4.02)	248 (9.76)	6 (0.24)	1.6 (0.06)	5 (0.20)	M5	4.2 (9.26)

Table 10.22 Three-Phase 400 V Class (IP20/UL Open Type)

Model	Dimensions mm (in)											Est. Weight kg (lb)	
	W	H	D	D1	D2	W1	W2	H1	H2	t1	t2		d
4002	140 (5.51)	260 (10.24)	176 (6.93)	138 (5.43)	38 (1.50)	102 (4.02)	102 (4.02)	248 (9.76)	6 (0.24)	1.6 (0.06)	5 (0.20)	M5	3.4 (7.50)
4004	140 (5.51)	260 (10.24)	176 (6.93)	138 (5.43)	38 (1.50)	102 (4.02)	102 (4.02)	248 (9.76)	6 (0.24)	1.6 (0.06)	5 (0.20)	M5	3.4 (7.50)
4005	140 (5.51)	260 (10.24)	176 (6.93)	138 (5.43)	38 (1.50)	102 (4.02)	102 (4.02)	248 (9.76)	6 (0.24)	1.6 (0.06)	5 (0.20)	M5	3.4 (7.50)
4007	140 (5.51)	260 (10.24)	211 (8.31)	138 (5.43)	73 (2.87)	102 (4.02)	102 (4.02)	248 (9.76)	6 (0.24)	1.6 (0.06)	5 (0.20)	M5	3.7 (8.16)
4009	140 (5.51)	260 (10.24)	211 (8.31)	138 (5.43)	73 (2.87)	102 (4.02)	102 (4.02)	248 (9.76)	6 (0.24)	1.6 (0.06)	5 (0.20)	M5	3.7 (8.16)

Specifications

10.7 Drive Exterior and Mounting Dimensions

Model	Dimensions mm (in)												Est. Weight kg (lb)
	W	H	D	D1	D2	W1	W2	H1	H2	t1	t2	d	
4012	140 (5.51)	260 (10.24)	211 (8.31)	138 (5.43)	73 (2.87)	102 (4.02)	102 (4.02)	248 (9.76)	6 (0.24)	1.6 (0.06)	5 (0.20)	M5	3.7 (8.16)
4018	140 (5.51)	260 (10.24)	211 (8.31)	138 (5.43)	73 (2.87)	102 (4.02)	102 (4.02)	248 (9.76)	6 (0.24)	1.6 (0.06)	5 (0.20)	M5	4.0 (8.82)
4023	140 (5.51)	260 (10.24)	211 (8.31)	138 (5.43)	73 (2.87)	102 (4.02)	102 (4.02)	248 (9.76)	6 (0.24)	1.6 (0.06)	5 (0.20)	M5	4.0 (8.82)

■ 2056, 4031, 4038

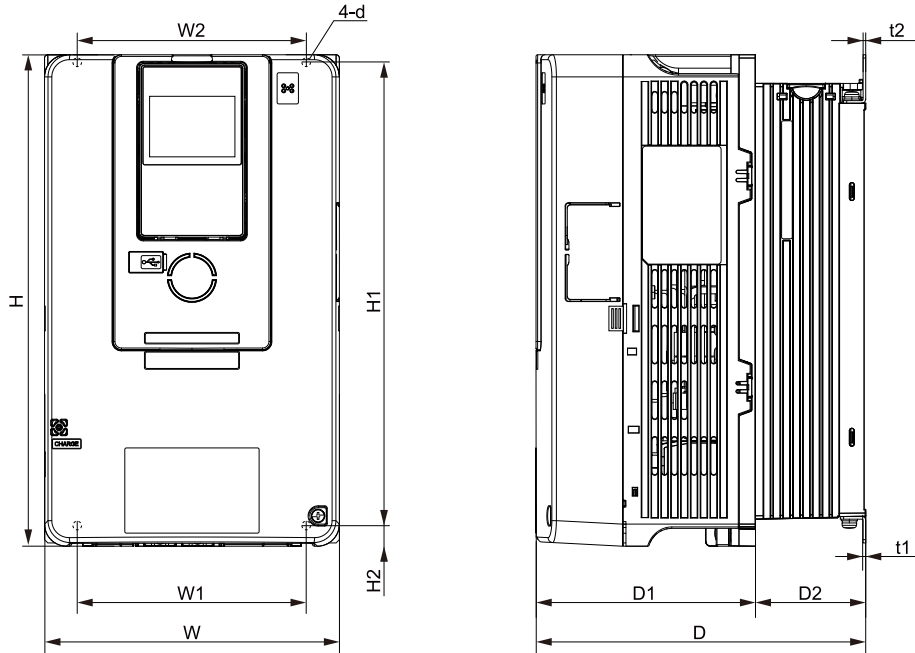

Figure 10.3 Dimension Diagram 2

Table 10.23 Three-Phase 200 V Class (IP20/UL Open Type)

Model	Dimensions mm (in)												Est. Weight kg (lb)
	W	H	D	D1	D2	W1	W2	H1	H2	t1	t2	d	
2056	180 (7.09)	300 (11.81)	202 (7.95)	134 (5.28)	68 (2.68)	140 (5.51)	140 (5.51)	284 (11.18)	8 (0.32)	1.6 (0.06)	1.6 (0.06)	M5	6 (13.23)

Table 10.24 Three-Phase 400 V Class (IP20/UL Open Type)

Model	Dimensions mm (in)												Est. Weight kg (lb)
	W	H	D	D1	D2	W1	W2	H1	H2	t1	t2	d	
4031	180 (7.09)	300 (11.81)	202 (7.95)	134 (5.28)	68 (2.68)	140 (5.51)	140 (5.51)	284 (11.18)	8 (0.32)	1.6 (0.06)	1.6 (0.06)	M5	5.5 (12.13)
4038	180 (7.09)	300 (11.81)	202 (7.95)	134 (5.28)	68 (2.68)	140 (5.51)	140 (5.51)	284 (11.18)	8 (0.32)	1.6 (0.06)	1.6 (0.06)	M5	5.5 (12.13)

■ 2070, 2082, 4044, 4060

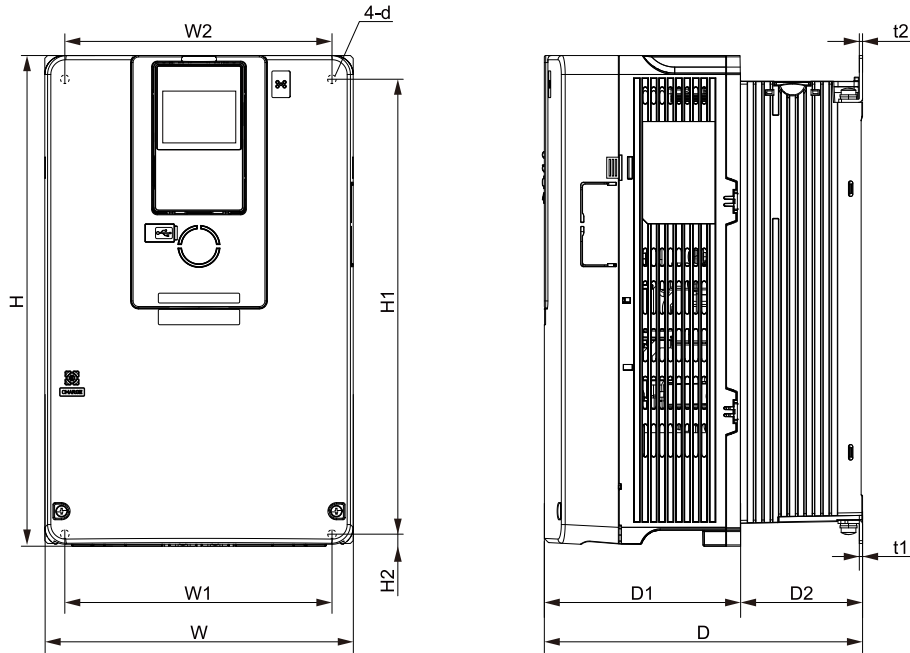

Figure 10.4 Dimension Diagram 3

Table 10.25 Three-Phase 200 V Class (IP20/UL Open Type)

Model	Dimensions mm (in)											Est. Weight kg (lb)	
	W	H	D	D1	D2	W1	W2	H1	H2	t1	t2		d
2070	220 (8.66)	350 (13.78)	227 (8.94)	140 (5.51)	87 (3.43)	192 (7.56)	192 (7.56)	335 (13.19)	8 (0.32)	2.3 (0.09)	2.3 (0.09)	M6	8.5 (18.74)
2082	220 (8.66)	350 (13.78)	227 (8.94)	140 (5.51)	87 (3.43)	192 (7.56)	192 (7.56)	335 (13.19)	8 (0.32)	2.3 (0.09)	2.3 (0.09)	M6	9.5 (20.95)

Table 10.26 Three-Phase 400 V Class (IP20/UL Open Type)

Model	Dimensions mm (in)											Est. Weight kg (lb)	
	W	H	D	D1	D2	W1	W2	H1	H2	t1	t2		d
4044	220 (8.66)	350 (13.78)	227 (8.94)	140 (5.51)	87 (3.43)	192 (7.56)	192 (7.56)	335 (13.19)	8 (0.32)	2.3 (0.09)	2.3 (0.09)	M6	8 (17.64)
4060	220 (8.66)	350 (13.78)	246 (9.69)	140 (5.51)	106 (4.17)	192 (7.56)	192 (7.56)	335 (13.19)	8 (0.32)	2.3 (0.09)	2.3 (0.09)	M6	13 (28.67)

■ 2110, 4075

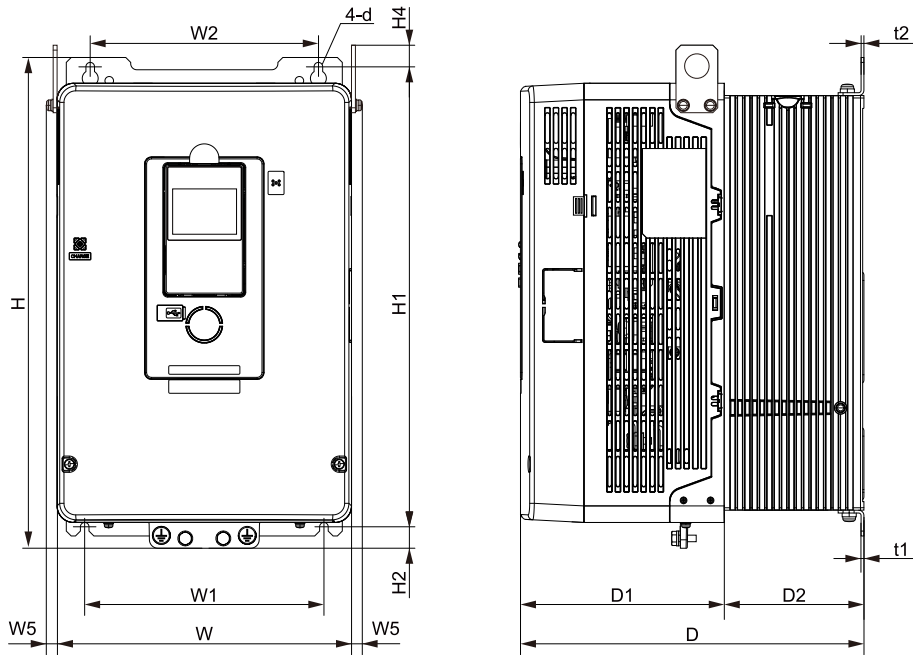

Figure 10.5 Dimension Diagram 4

Table 10.27 Three-Phase 200 V Class (IP20/UL Open Type, No Internal EMC Filter)

Model	Dimensions mm (in)														Est. Weight kg (lb)
	W	H	D	D1	D2	W1	W2	W5 (Maximum)	H1	H2	H4	t1	t2	d	
2110	240 (9.45)	400 (15.75)	280 (11.02)	166 (6.54)	114 (4.49)	195 (7.68)	186 (7.32)	12 (0.47)	375 (14.76)	17.5 (0.69)	17.5 (0.69)	2.3 (0.09)	2.3 (0.09)	M6	18 (39.69)

Table 10.28 Three-Phase 200 V Class (IP20/UL Open Type, with Built-in EMC Filter)

Model	Dimensions mm (in)														Est. Weight kg (lb)
	W	H	D	D1	D2	W1	W2	W5 (Maximum)	H1	H2	H4	t1	t2	d	
2110	240 (9.45)	400 (15.75)	280 (11.02)	166 (6.54)	114 (4.49)	195 (7.68)	186 (7.32)	12 (0.47)	375 (14.76)	17.5 (0.69)	17.5 (0.69)	2.3 (0.09)	2.3 (0.09)	M6	19 (41.90)

Table 10.29 Three-Phase 400 V Class (IP20/UL Open Type)

Model	Dimensions mm (in)														Est. Weight kg (lb)
	W	H	D	D1	D2	W1	W2	W5 (Maximum)	H1	H2	H4	t1	t2	d	
4075	240 (9.45)	400 (15.75)	280 (11.02)	166 (6.54)	114 (4.49)	195 (7.68)	186 (7.32)	12 (0.47)	375 (14.76)	17.5 (0.69)	17.5 (0.69)	2.3 (0.09)	2.3 (0.09)	M6	15 (33.08)

■ 2138, 4089, 4103

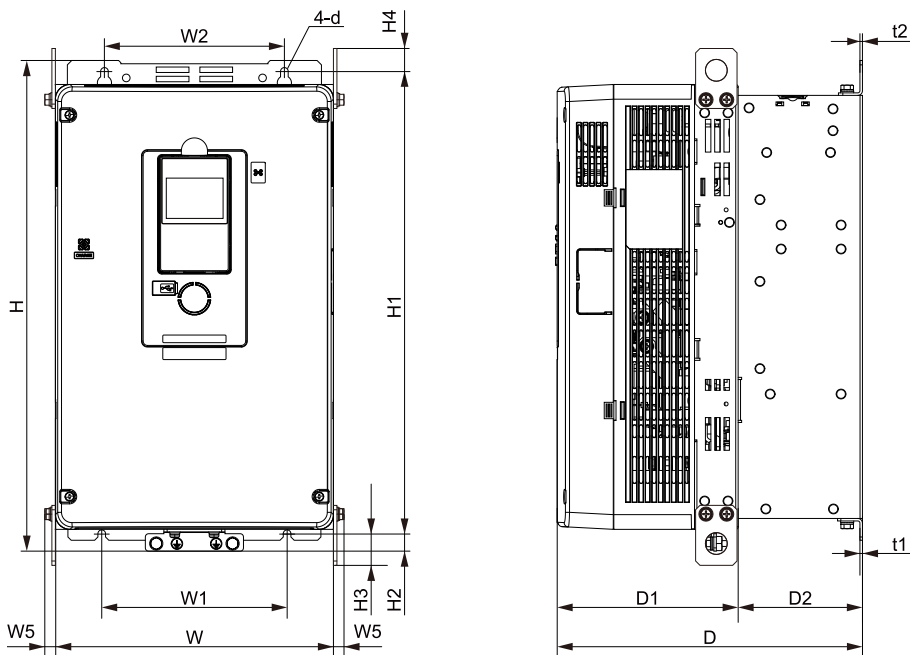

Figure 10.6 Dimension Diagram 5

Table 10.30 Three-Phase 200 V Class (IP20/UL Open Type, No Internal EMC Filter)

Model	Dimensions mm (in)															Est. Weight kg (lb)
	W	H	D	D1	D2	W1	W2	W5 (Maximum)	H1	H2	H3	H4	t1	t2	d	
2138	255 (10.04)	450 (17.72)	280 (11.02)	166 (6.54)	114 (4.49)	170 (6.69)	165 (6.50)	12 (0.47)	424 (16.69)	16 (0.63)	29 (1.14)	21 (0.83)	2.3 (0.09)	2.3 (0.09)	M6	21 (46.31)

Table 10.31 Three-Phase 200 V Class (IP20/UL Open Type, with Built-in EMC Filter)

Model	Dimensions mm (in)															Est. Weight kg (lb)
	W	H	D	D1	D2	W1	W2	W5 (Maximum)	H1	H2	H3	H4	t1	t2	d	
2138	255 (10.04)	450 (17.72)	280 (11.02)	166 (6.54)	114 (4.49)	170 (6.69)	165 (6.50)	12 (0.47)	424 (16.69)	16 (0.63)	29 (1.14)	21 (0.83)	2.3 (0.09)	2.3 (0.09)	M6	22 (48.51)

Table 10.32 Three-Phase 400 V Class (IP20/UL Open Type, No Internal EMC Filter)

Model	Dimensions mm (in)															Est. Weight kg (lb)
	W	H	D	D1	D2	W1	W2	W5 (Maximum)	H1	H2	H3	H4	t1	t2	d	
4089	255 (10.04)	450 (17.72)	280 (11.02)	166 (6.54)	114 (4.49)	170 (6.69)	165 (6.50)	12 (0.47)	424 (16.69)	16 (0.63)	29 (1.14)	21 (0.83)	2.3 (0.09)	2.3 (0.09)	M6	20 (44.10)
4103	255 (10.04)	450 (17.72)	280 (11.02)	166 (6.54)	114 (4.49)	170 (6.69)	165 (6.50)	12 (0.47)	424 (16.69)	16 (0.63)	29 (1.14)	21 (0.83)	2.3 (0.09)	2.3 (0.09)	M6	24 (52.92)

Table 10.33 Three-Phase 400 V Class (IP20/UL Open Type, with Built-in EMC Filter)

Model	Dimensions mm (in)															Est. Weight kg (lb)
	W	H	D	D1	D2	W1	W2	W5 (Maximum)	H1	H2	H3	H4	t1	t2	d	
4089	255 (10.04)	450 (17.72)	280 (11.02)	166 (6.54)	114 (4.49)	170 (6.69)	165 (6.50)	12 (0.47)	424 (16.69)	16 (0.63)	29 (1.14)	21 (0.83)	2.3 (0.09)	2.3 (0.09)	M6	21 (46.31)
4103	255 (10.04)	450 (17.72)	280 (11.02)	166 (6.54)	114 (4.49)	170 (6.69)	165 (6.50)	12 (0.47)	424 (16.69)	16 (0.63)	29 (1.14)	21 (0.83)	2.3 (0.09)	2.3 (0.09)	M6	25 (55.13)

Specifications

■ 2169, 2211, 4140, 4168

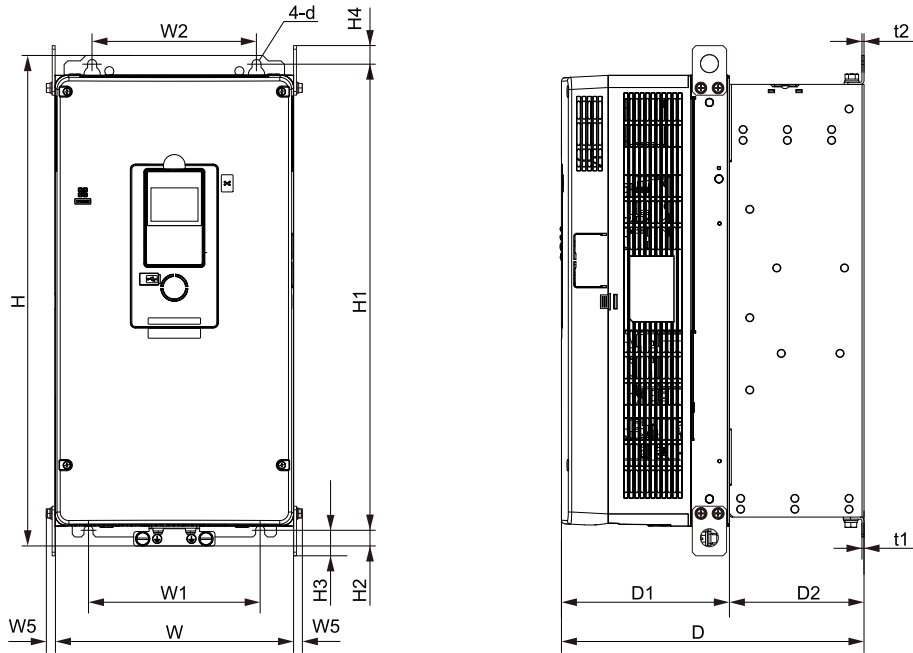

Figure 10.7 Dimension Diagram 6

Table 10.34 Three-Phase 200 V Class (IP20/UL Open Type, No Internal EMC Filter)

Model	Dimensions mm (in)															Est. Weight kg (lb)
	W	H	D	D1	D2	W1	W2	W5 (Maximum)	H1	H2	H3	H4	t1	t2	d	
2169	264 (10.39)	543 (21.38)	335 (13.19)	186 (7.32)	149 (5.87)	190 (7.48)	182 (7.17)	12 (0.47)	516 (20.31)	17.5 (0.69)	28.5 (1.12)	20.5 (0.81)	2.3 (0.09)	2.3 (0.09)	M8	34 (74.97)
2211	264 (10.39)	543 (21.38)	335 (13.19)	186 (7.32)	149 (5.87)	190 (7.48)	182 (7.17)	12 (0.47)	516 (20.31)	17.5 (0.69)	28.5 (1.12)	20.5 (0.81)	2.3 (0.09)	2.3 (0.09)	M8	35 (77.18)

Table 10.35 Three-Phase 200 V Class (IP20/UL Open Type, with Built-in EMC Filter)

Model	Dimensions mm (in)															Est. Weight kg (lb)
	W	H	D	D1	D2	W1	W2	W5 (Maximum)	H1	H2	H3	H4	t1	t2	d	
2169	264 (10.39)	543 (21.38)	335 (13.19)	186 (7.32)	149 (5.87)	190 (7.48)	182 (7.17)	12 (0.47)	516 (20.31)	17.5 (0.69)	28.5 (1.12)	20.5 (0.81)	2.3 (0.09)	2.3 (0.09)	M8	35 (77.18)
2211	264 (10.39)	543 (21.38)	335 (13.19)	186 (7.32)	149 (5.87)	190 (7.48)	182 (7.17)	12 (0.47)	516 (20.31)	17.5 (0.69)	28.5 (1.12)	20.5 (0.81)	2.3 (0.09)	2.3 (0.09)	M8	36 (79.38)

Table 10.36 Three-Phase 400 V Class (IP20/UL Open Type, No Internal EMC Filter)

Model	Dimensions mm (in)															Est. Weight kg (lb)
	W	H	D	D1	D2	W1	W2	W5 (Maximum)	H1	H2	H3	H4	t1	t2	d	
4140	264 (10.39)	543 (21.38)	335 (13.19)	186 (7.32)	149 (5.87)	190 (7.48)	182 (7.17)	12 (0.47)	516 (20.31)	17.5 (0.69)	28.5 (1.12)	20.5 (0.81)	2.3 (0.09)	2.3 (0.09)	M8	36 (79.38)
4168	264 (10.39)	543 (21.38)	335 (13.19)	186 (7.32)	149 (5.87)	190 (7.48)	182 (7.17)	12 (0.47)	516 (20.31)	17.5 (0.69)	28.5 (1.12)	20.5 (0.81)	2.3 (0.09)	2.3 (0.09)	M8	37 (81.59)

Table 10.37 Three-Phase 400 V Class (IP20/UL Open Type, with Built-in EMC Filter)

Model	Dimensions mm (in)															Est. Weight kg (lb)
	W	H	D	D1	D2	W1	W2	W5 (Maximum)	H1	H2	H3	H4	t1	t2	d	
4140	264 (10.39)	543 (21.38)	335 (13.19)	186 (7.32)	149 (5.87)	190 (7.48)	182 (7.17)	12 (0.47)	516 (20.31)	17.5 (0.69)	28.5 (1.12)	20.5 (0.81)	2.3 (0.09)	2.3 (0.09)	M8	37 (81.59)
4168	264 (10.39)	543 (21.38)	335 (13.19)	186 (7.32)	149 (5.87)	190 (7.48)	182 (7.17)	12 (0.47)	516 (20.31)	17.5 (0.69)	28.5 (1.12)	20.5 (0.81)	2.3 (0.09)	2.3 (0.09)	M8	38 (83.79)

■ 2257, 2313, 4208 to 4296

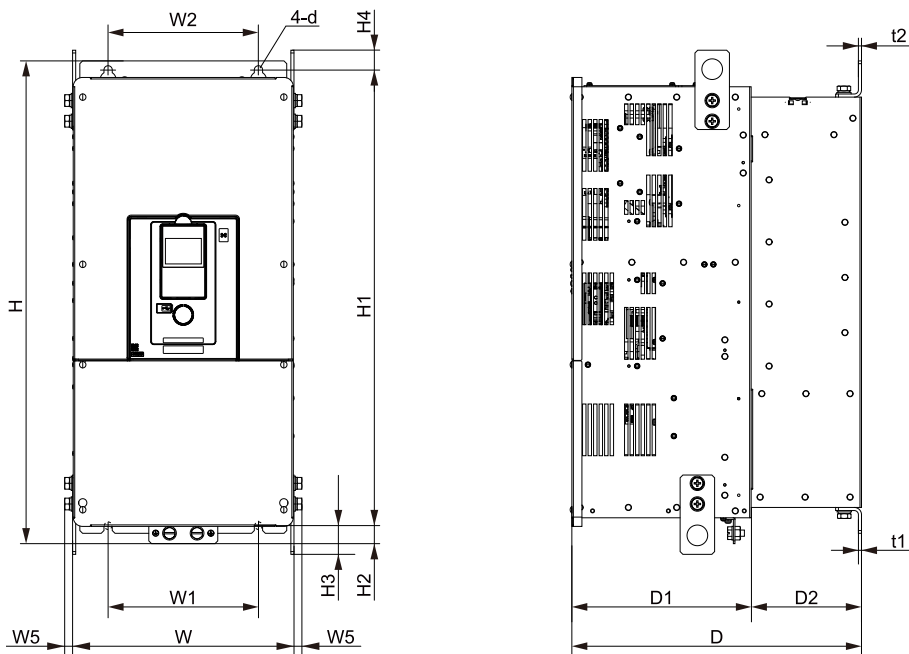

Figure 10.8 Dimension Diagram 7

Table 10.38 Three-Phase 200 V Class (IP20/UL Open Type, No Internal EMC Filter)

Model	Dimensions mm (in)															Est. Weight kg (lb)
	W	H	D	D1	D2	W1	W2	W5 (Maximum)	H1	H2	H3	H4	t1	t2	d	
2257	312 (12.28)	700 (27.56)	420 (16.54)	260 (10.24)	160 (6.30)	218 (8.58)	218 (8.58)	18 (0.71)	659 (25.94)	28 (1.10)	43.5 (1.71)	28.5 (1.12)	4.5 (0.18)	4.5 (0.18)	M10	58 (127.89)
2313	312 (12.28)	700 (27.56)	420 (16.54)	260 (10.24)	160 (6.30)	218 (8.58)	218 (8.58)	18 (0.71)	659 (25.94)	28 (1.10)	43.5 (1.71)	28.5 (1.12)	4.5 (0.18)	4.5 (0.18)	M10	61 (134.51)

Table 10.39 Three-Phase 200 V Class (IP20/UL Open Type, with Built-in EMC Filter)

Model	Dimensions mm (in)															Est. Weight kg (lb)
	W	H	D	D1	D2	W1	W2	W5 (Maximum)	H1	H2	H3	H4	t1	t2	d	
2257	312 (12.28)	700 (27.56)	420 (16.54)	260 (10.24)	160 (6.30)	218 (8.58)	218 (8.58)	18 (0.71)	659 (25.94)	28 (1.10)	43.5 (1.71)	28.5 (1.12)	4.5 (0.18)	4.5 (0.18)	M10	59 (130.10)
2313	312 (12.28)	700 (27.56)	420 (16.54)	260 (10.24)	160 (6.30)	218 (8.58)	218 (8.58)	18 (0.71)	659 (25.94)	28 (1.10)	43.5 (1.71)	28.5 (1.12)	4.5 (0.18)	4.5 (0.18)	M10	61 (134.51)

Table 10.40 Three-Phase 400 V Class (IP20/UL Open Type, No Internal EMC Filter)

Model	Dimensions mm (in)															Est. Weight kg (lb)
	W	H	D	D1	D2	W1	W2	W5 (Maximum)	H1	H2	H3	H4	t1	t2	d	
4208	312 (12.28)	700 (27.56)	420 (16.54)	260 (10.24)	160 (6.30)	218 (8.58)	218 (8.58)	18 (0.71)	659 (25.94)	28 (1.10)	43.5 (1.71)	28.5 (1.12)	4.5 (0.18)	4.5 (0.18)	M10	60 (132.30)
4250	312 (12.28)	700 (27.56)	420 (16.54)	260 (10.24)	160 (6.30)	218 (8.58)	218 (8.58)	18 (0.71)	659 (25.94)	28 (1.10)	43.5 (1.71)	28.5 (1.12)	4.5 (0.18)	4.5 (0.18)	M10	62 (136.71)
4296	312 (12.28)	700 (27.56)	420 (16.54)	260 (10.24)	160 (6.30)	218 (8.58)	218 (8.58)	18 (0.71)	659 (25.94)	28 (1.10)	43.5 (1.71)	28.5 (1.12)	4.5 (0.18)	4.5 (0.18)	M10	65 (143.33)

Table 10.41 Three-Phase 400 V Class (IP20/UL Open Type, with Built-in EMC Filter)

Model	Dimensions mm (in)															Est. Weight kg (lb)
	W	H	D	D1	D2	W1	W2	W5 (Maximum)	H1	H2	H3	H4	t1	t2	d	
4208	312 (12.28)	700 (27.56)	420 (16.54)	260 (10.24)	160 (6.30)	218 (8.58)	218 (8.58)	18 (0.71)	659 (25.94)	28 (1.10)	43.5 (1.71)	28.5 (1.12)	4.5 (0.18)	4.5 (0.18)	M10	61 (134.51)
4250	312 (12.28)	700 (27.56)	420 (16.54)	260 (10.24)	160 (6.30)	218 (8.58)	218 (8.58)	18 (0.71)	659 (25.94)	28 (1.10)	43.5 (1.71)	28.5 (1.12)	4.5 (0.18)	4.5 (0.18)	M10	63 (138.92)
4296	312 (12.28)	700 (27.56)	420 (16.54)	260 (10.24)	160 (6.30)	218 (8.58)	218 (8.58)	18 (0.71)	659 (25.94)	28 (1.10)	43.5 (1.71)	28.5 (1.12)	4.5 (0.18)	4.5 (0.18)	M10	66 (145.53)

■ 2360, 2415, 4371, 4389

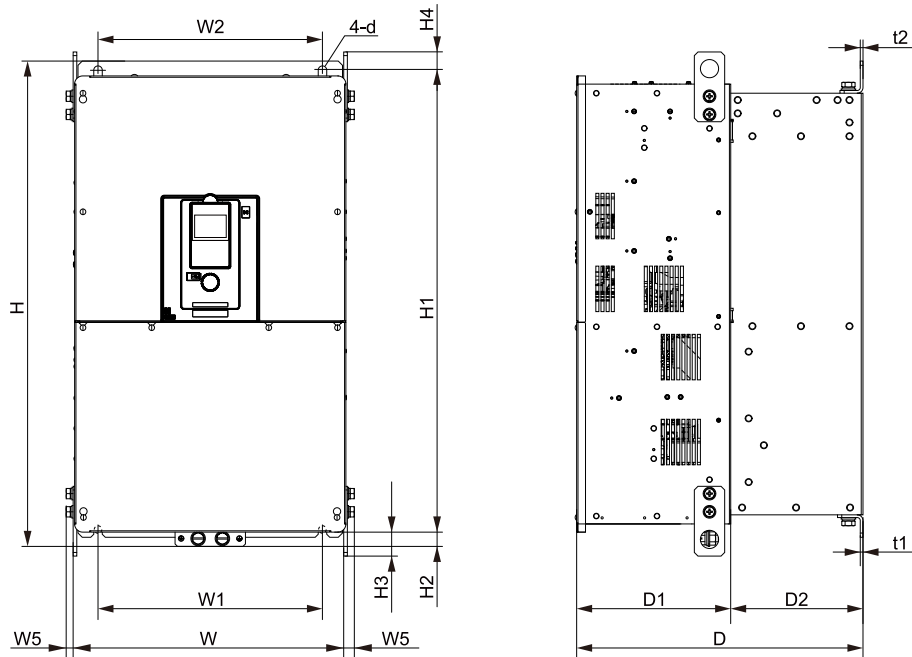

Figure 10.9 Dimension Diagram 8

Table 10.42 Three-Phase 200 V Class (IP20/UL Open Type, No Internal EMC Filter)

Model	Dimensions mm (in)															Est. Weight kg (lb)
	W	H	D	D1	D2	W1	W2	W5 (Maximum)	H1	H2	H3	H4	t1	t2	d	
2360	440 (17.32)	800 (31.50)	472 (18.58)	254 (10.00)	218 (8.58)	370 (14.57)	370 (14.57)	20 (0.79)	757 (29.80)	28 (1.10)	44 (1.73)	30 (1.18)	4.5 (0.18)	4.5 (0.18)	M12	100 (220.50)
2415	440 (17.32)	800 (31.50)	472 (18.58)	254 (10.00)	218 (8.58)	370 (14.57)	370 (14.57)	20 (0.79)	757 (29.80)	28 (1.10)	44 (1.73)	30 (1.18)	4.5 (0.18)	4.5 (0.18)	M12	106 (233.73)

Table 10.43 Three-Phase 200 V Class (IP20/UL Open Type, with Built-in EMC Filter)

Model	Dimensions mm (in)															Est. Weight kg (lb)
	W	H	D	D1	D2	W1	W2	W5 (Maximum)	H1	H2	H3	H4	t1	t2	d	
2360	440 (17.32)	800 (31.50)	472 (18.58)	254 (10.00)	218 (8.58)	370 (14.57)	370 (14.57)	20 (0.79)	757 (29.80)	28 (1.10)	44 (1.73)	30 (1.18)	4.5 (0.18)	4.5 (0.18)	M12	106 (233.73)
2415	440 (17.32)	800 (31.50)	472 (18.58)	254 (10.00)	218 (8.58)	370 (14.57)	370 (14.57)	20 (0.79)	757 (29.80)	28 (1.10)	44 (1.73)	30 (1.18)	4.5 (0.18)	4.5 (0.18)	M12	112 (246.96)

Table 10.44 Three-Phase 400 V Class (IP20/UL Open Type, No Internal EMC Filter)

Model	Dimensions mm (in)															Est. Weight kg (lb)
	W	H	D	D1	D2	W1	W2	W5 (Maximum)	H1	H2	H3	H4	t1	t2	d	
4371	440 (17.32)	800 (31.50)	472 (18.58)	254 (10.00)	218 (8.58)	370 (14.57)	370 (14.57)	20 (0.79)	757 (29.80)	28 (1.10)	44 (1.73)	30 (1.18)	4.5 (0.18)	4.5 (0.18)	M12	106 (233.73)
4389	440 (17.32)	800 (31.50)	472 (18.58)	254 (10.00)	218 (8.58)	370 (14.57)	370 (14.57)	20 (0.79)	757 (29.80)	28 (1.10)	44 (1.73)	30 (1.18)	4.5 (0.18)	4.5 (0.18)	M12	112 (246.96)

Table 10.45 Three-Phase 400 V Class (IP20/UL Open Type, with Built-in EMC Filter)

Model	Dimensions mm (in)															Est. Weight kg (lb)
	W	H	D	D1	D2	W1	W2	W5 (Maximum)	H1	H2	H3	H4	t1	t2	d	
4371	440 (17.32)	800 (31.50)	472 (18.58)	254 (10.00)	218 (8.58)	370 (14.57)	370 (14.57)	20 (0.79)	757 (29.80)	28 (1.10)	44 (1.73)	30 (1.18)	4.5 (0.18)	4.5 (0.18)	M12	111 (244.76)
4389	440 (17.32)	800 (31.50)	472 (18.58)	254 (10.00)	218 (8.58)	370 (14.57)	370 (14.57)	20 (0.79)	757 (29.80)	28 (1.10)	44 (1.73)	30 (1.18)	4.5 (0.18)	4.5 (0.18)	M12	117 (257.99)

■ 4453 - 4675

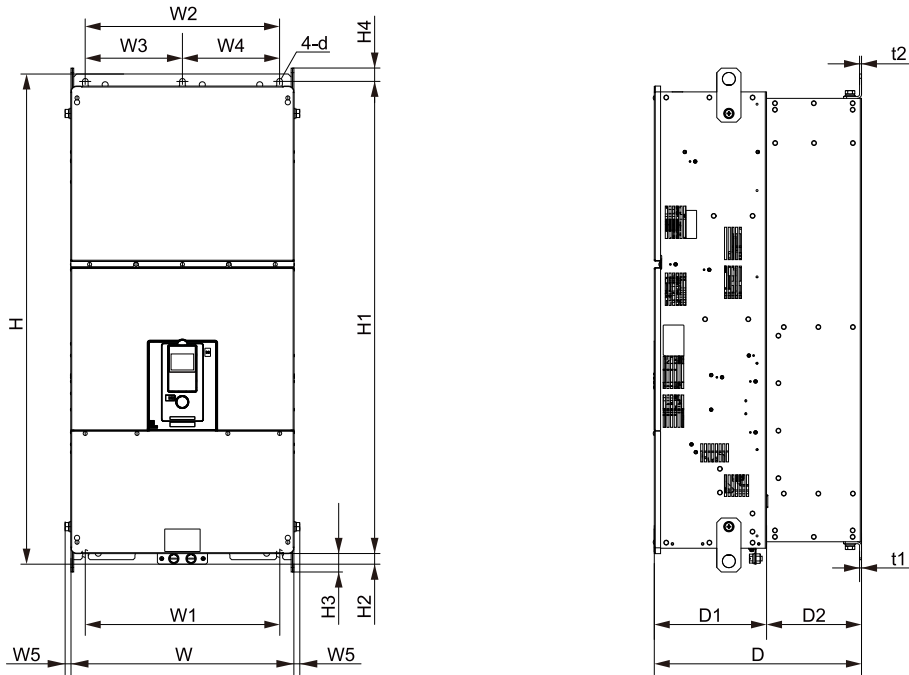

Figure 10.10 Dimension Diagram 9

Table 10.46 Three-Phase 400 V Class (IP20/UL Open Type)

Model	Dimensions mm (in)																	Est. Weight kg (lb)
	W	H	D	D1	D2	W1	W2	W3	W4	W5 (Maximum)	H1	H2	H3	H4	t1	t2	d	
4453	510 (20.08)	1136 (44.72)	480 (18.90)	260 (10.24)	220 (8.66)	450 (17.72)	450 (17.72)	225 (8.86)	225 (8.86)	20 (0.79)	1093 (43.03)	25.5 (1.00)	43.5 (1.71)	30.5 (1.20)	4.5 (0.18)	4.5 (0.18)	M12	198 (436.59)
4568	510 (20.08)	1136 (44.72)	480 (18.90)	260 (10.24)	220 (8.66)	450 (17.72)	450 (17.72)	225 (8.86)	225 (8.86)	20 (0.79)	1093 (43.03)	25.5 (1.00)	43.5 (1.71)	30.5 (1.20)	4.5 (0.18)	4.5 (0.18)	M12	198 (436.59)
4675	510 (20.08)	1136 (44.72)	480 (18.90)	260 (10.24)	220 (8.66)	450 (17.72)	450 (17.72)	225 (8.86)	225 (8.86)	20 (0.79)	1093 (43.03)	25.5 (1.00)	43.5 (1.71)	30.5 (1.20)	4.5 (0.18)	4.5 (0.18)	M12	207 (456.44)

■ **4810 - 4H12**

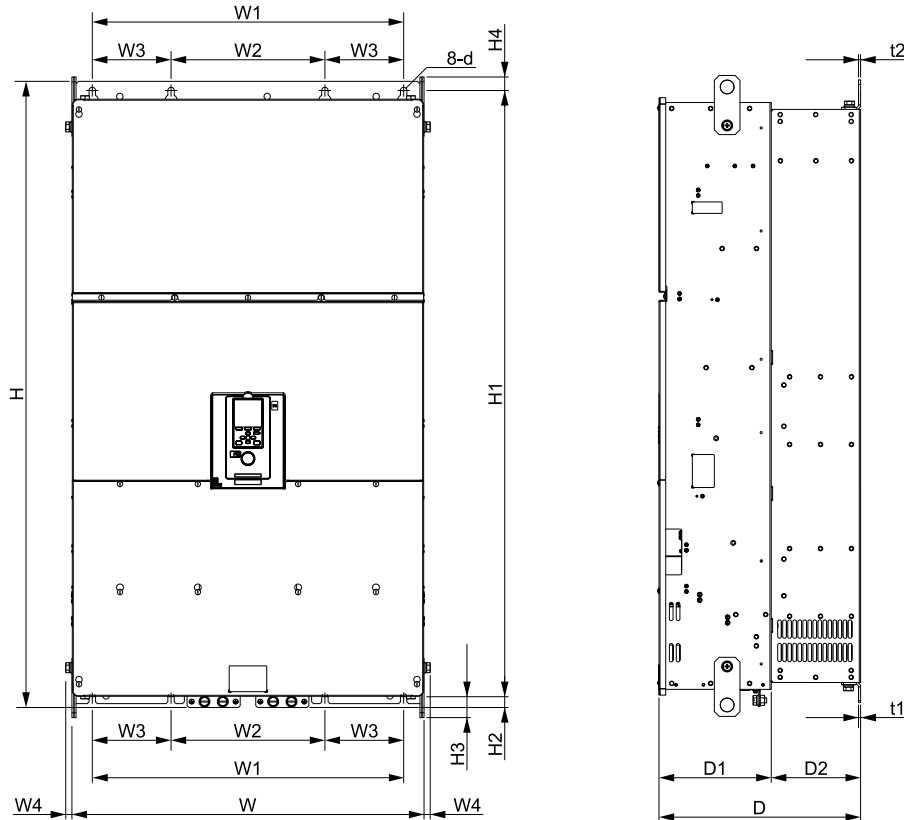

Figure 10.11 Dimension Diagram 10

Table 10.47 Three-Phase 400 V Class (IP00/UL Open Type)

Model	Dimensions mm (in)																Est. Weight kg (lb)
	W	H	D	D1	D2	W1	W2	W3	W4 (Maximum)	H1	H2	H3	H4	t1	t2	d	
4810	760 (29.92)	1367.5 (53.84)	440 (17.32)	245 (9.65)	195 (7.68)	680 (26.77)	336 (13.23)	172 (6.77)	20 (0.79)	1324 (52.13)	23.5 (0.93)	45.5 (1.79)	29.5 (1.16)	4.5 (0.18)	4.5 (0.18)	M12	363 (800.42)
4930	760 (29.92)	1367.5 (53.84)	440 (17.32)	245 (9.65)	195 (7.68)	680 (26.77)	336 (13.23)	172 (6.77)	20 (0.79)	1324 (52.13)	23.5 (0.93)	45.5 (1.79)	29.5 (1.16)	4.5 (0.18)	4.5 (0.18)	M12	363 (800.42)
4H11	760 (29.92)	1367.5 (53.84)	440 (17.32)	245 (9.65)	195 (7.68)	680 (26.77)	336 (13.23)	172 (6.77)	20 (0.79)	1324 (52.13)	23.5 (0.93)	45.5 (1.79)	29.5 (1.16)	4.5 (0.18)	4.5 (0.18)	M12	368 (811.44)
4H12	760 (29.92)	1367.5 (53.84)	440 (17.32)	245 (9.65)	195 (7.68)	680 (26.77)	336 (13.23)	172 (6.77)	20 (0.79)	1324 (52.13)	23.5 (0.93)	45.5 (1.79)	29.5 (1.16)	4.5 (0.18)	4.5 (0.18)	M12	368 (811.44)

◆ IP20/UL Type1

■ 2004 - 2042, 4002 - 4023

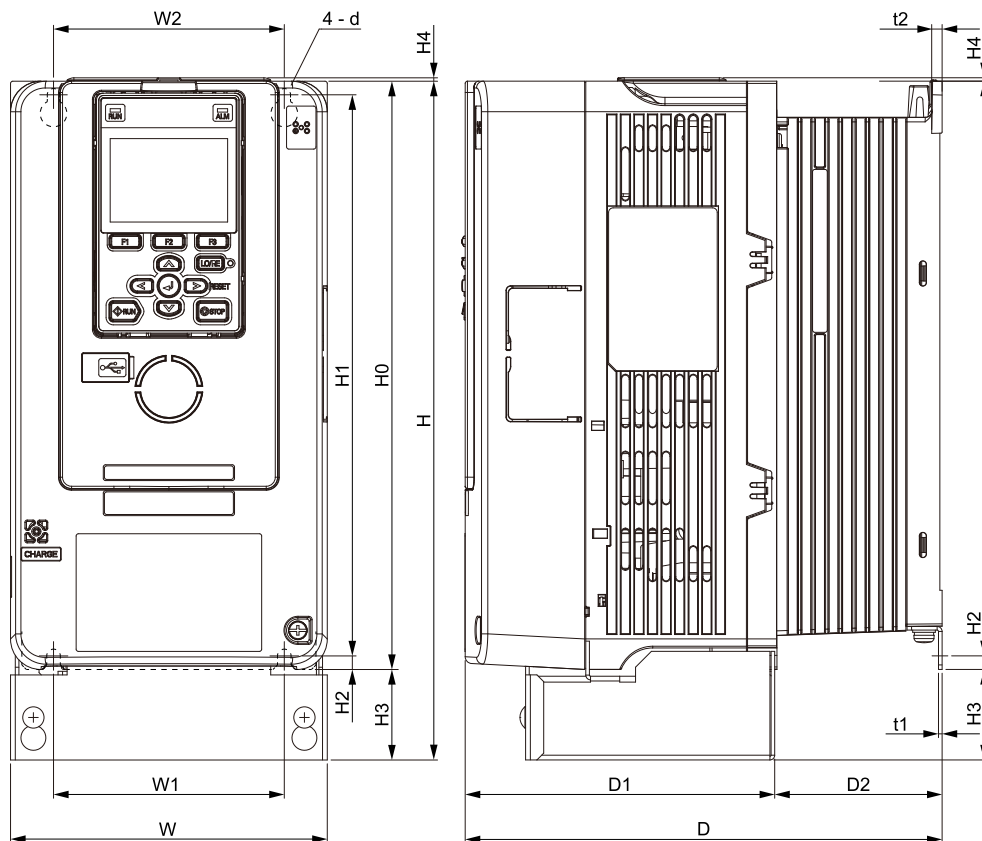

Figure 10.12 Dimension Diagram 1

Table 10.48 Three-Phase 200 V Class (IP20/UL Type 1)

Model	Dimensions mm (in)															Est. Weight kg (lb)
	W	H	D	D1	D2	W1	W2	H0	H1	H2	H3	H4	t1	t2	d	
2004	140 (5.51)	300 (11.81)	175.8 (6.92)	136.8 (5.39)	39 (1.54)	102 (4.02)	102 (4.02)	260 (10.24)	248 (9.76)	6 (0.24)	40 (1.57)	1.5 (0.06)	1.6 (0.06)	5 (0.20)	M5	4.1 (9.04)
2006	140 (5.51)	300 (11.81)	175.8 (6.92)	136.8 (5.39)	39 (1.54)	102 (4.02)	102 (4.02)	260 (10.24)	248 (9.76)	6 (0.24)	40 (1.57)	1.5 (0.06)	1.6 (0.06)	5 (0.20)	M5	4.1 (9.04)
2010	140 (5.51)	300 (11.81)	175.8 (6.92)	136.8 (5.39)	39 (1.54)	102 (4.02)	102 (4.02)	260 (10.24)	248 (9.76)	6 (0.24)	40 (1.57)	1.5 (0.06)	1.6 (0.06)	5 (0.20)	M5	4.1 (9.04)
2012	140 (5.51)	300 (11.81)	175.8 (6.92)	136.8 (5.39)	39 (1.54)	102 (4.02)	102 (4.02)	260 (10.24)	248 (9.76)	6 (0.24)	40 (1.57)	1.5 (0.06)	1.6 (0.06)	5 (0.20)	M5	4.1 (9.04)
2018	140 (5.51)	300 (11.81)	210.8 (8.3)	136.8 (5.39)	74 (2.91)	102 (4.02)	102 (4.02)	260 (10.24)	248 (9.76)	6 (0.24)	40 (1.57)	1.5 (0.06)	1.6 (0.06)	4.6 (0.18)	M5	4.4 (9.70)
2021	140 (5.51)	300 (11.81)	210.8 (8.3)	136.8 (5.39)	74 (2.91)	102 (4.02)	102 (4.02)	260 (10.24)	248 (9.76)	6 (0.24)	40 (1.57)	1.5 (0.06)	1.6 (0.06)	4.6 (0.18)	M5	4.4 (9.70)
2030	140 (5.51)	300 (11.81)	210.8 (8.3)	136.8 (5.39)	74 (2.91)	102 (4.02)	102 (4.02)	260 (10.24)	248 (9.76)	6 (0.24)	40 (1.57)	1.5 (0.06)	1.6 (0.06)	4.6 (0.18)	M5	4.8 (10.58)
2042	140 (5.51)	300 (11.81)	210.8 (8.3)	136.8 (5.39)	74 (2.91)	102 (4.02)	102 (4.02)	260 (10.24)	248 (9.76)	6 (0.24)	40 (1.57)	1.5 (0.06)	1.6 (0.06)	4.6 (0.18)	M5	4.8 (10.58)

Table 10.49 Three-Phase 400 V Class (IP20/UL Type 1)

Model	Dimensions mm (in)															Est. Weight kg (lb)
	W	H	D	D1	D2	W1	W2	H0	H1	H2	H3	H4	t1	t2	d	
4002	140 (5.51)	300 (11.81)	175.8 (6.92)	136.8 (5.39)	39 (1.54)	102 (4.02)	102 (4.02)	260 (10.24)	248 (9.76)	6 (0.24)	40 (1.57)	1.5 (0.06)	1.6 (0.06)	5 (0.20)	M5	4 (8.82)
4004	140 (5.51)	300 (11.81)	175.8 (6.92)	136.8 (5.39)	39 (1.54)	102 (4.02)	102 (4.02)	260 (10.24)	248 (9.76)	6 (0.24)	40 (1.57)	1.5 (0.06)	1.6 (0.06)	5 (0.20)	M5	4 (8.82)

Specifications

10.7 Drive Exterior and Mounting Dimensions

Model	Dimensions mm (in)															Est. Weight kg (lb)
	W	H	D	D1	D2	W1	W2	H0	H1	H2	H3	H4	t1	t2	d	
4005	140 (5.51)	300 (11.81)	175.8 (6.92)	136.8 (5.39)	39 (1.54)	102 (4.02)	102 (4.02)	260 (10.24)	248 (9.76)	6 (0.24)	40 (1.57)	1.5 (0.06)	1.6 (0.06)	5 (0.20)	M5	4 (8.82)
4007	140 (5.51)	300 (11.81)	210.8 (8.3)	136.8 (5.39)	74 (2.91)	102 (4.02)	102 (4.02)	260 (10.24)	248 (9.76)	6 (0.24)	40 (1.57)	1.5 (0.06)	1.6 (0.06)	4.6 (0.18)	M5	4.3 (9.48)
4009	140 (5.51)	300 (11.81)	210.8 (8.3)	136.8 (5.39)	74 (2.91)	102 (4.02)	102 (4.02)	260 (10.24)	248 (9.76)	6 (0.24)	40 (1.57)	1.5 (0.06)	1.6 (0.06)	4.6 (0.18)	M5	4.3 (9.48)
4012	140 (5.51)	300 (11.81)	210.8 (8.3)	136.8 (5.39)	74 (2.91)	102 (4.02)	102 (4.02)	260 (10.24)	248 (9.76)	6 (0.24)	40 (1.57)	1.5 (0.06)	1.6 (0.06)	4.6 (0.18)	M5	4.3 (9.48)
4018	140 (5.51)	300 (11.81)	210.8 (8.3)	136.8 (5.39)	74 (2.91)	102 (4.02)	102 (4.02)	260 (10.24)	248 (9.76)	6 (0.24)	40 (1.57)	1.5 (0.06)	1.6 (0.06)	4.6 (0.18)	M5	4.6 (10.14)
4023	140 (5.51)	300 (11.81)	210.8 (8.3)	136.8 (5.39)	74 (2.91)	102 (4.02)	102 (4.02)	260 (10.24)	248 (9.76)	6 (0.24)	40 (1.57)	1.5 (0.06)	1.6 (0.06)	4.6 (0.18)	M5	4.6 (10.14)

■ 2056, 4031, 4038

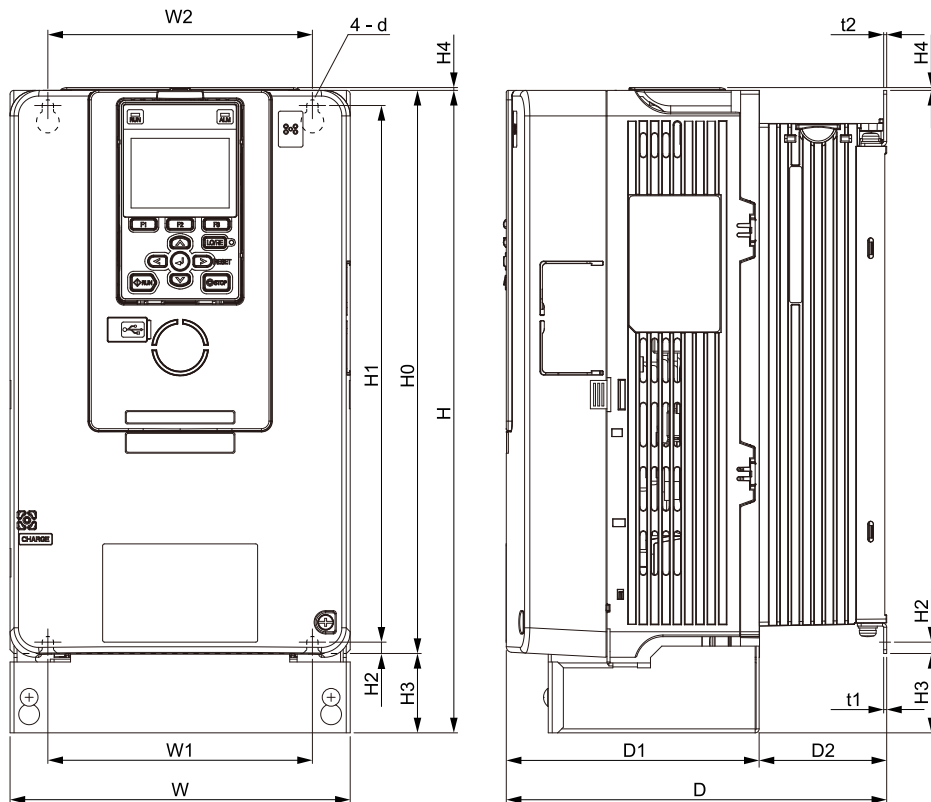

Figure 10.13 Dimension Diagram 2

Table 10.50 Three-Phase 200 V Class (IP20/UL Type 1)

Model	Dimensions mm (in)															Est. Weight kg (lb)
	W	H	D	D1	D2	W1	W2	H0	H1	H2	H3	H4	t1	t2	d	
2056	180 (7.09)	340 (13.39)	201.3 (7.93)	133.8 (5.27)	67.5 (2.66)	140 (5.51)	140 (5.51)	298 (11.73)	284 (11.18)	6 (0.24)	42 (1.65)	1.5 (0.06)	1.6 (0.06)	1.6 (0.06)	M5	7 (15.44)

Table 10.51 Three-Phase 400 V Class (IP20/UL Type 1)

Model	Dimensions mm (in)															Est. Weight kg (lb)
	W	H	D	D1	D2	W1	W2	H0	H1	H2	H3	H4	t1	t2	d	
4031	180 (7.09)	340 (13.39)	201.3 (7.93)	133.8 (5.27)	67.5 (2.66)	140 (5.51)	140 (5.51)	298 (11.73)	284 (11.18)	6 (0.24)	42 (1.65)	1.5 (0.06)	1.6 (0.06)	1.6 (0.06)	M5	6.5 (14.33)
4038	180 (7.09)	340 (13.39)	201.3 (7.93)	133.8 (5.27)	67.5 (2.66)	140 (5.51)	140 (5.51)	298 (11.73)	284 (11.18)	6 (0.24)	42 (1.65)	1.5 (0.06)	1.6 (0.06)	1.6 (0.06)	M5	6.5 (14.33)

■ 2070, 2082, 4044, 4060

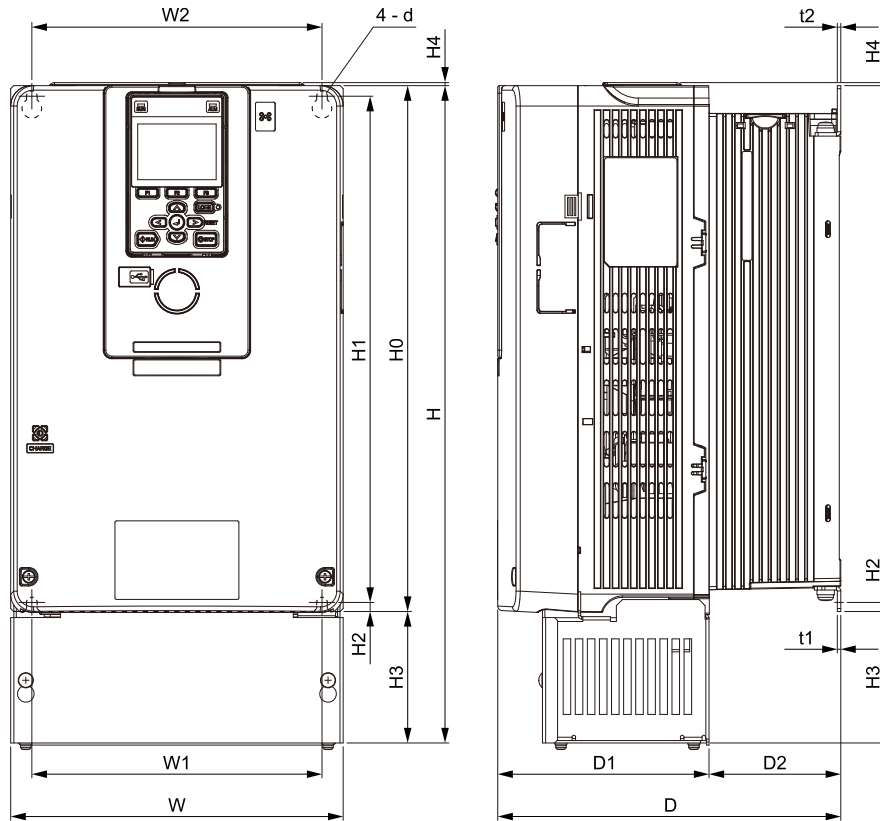

Figure 10.14 Dimension Diagram 3

Table 10.52 Three-Phase 200 V Class (IP20/UL Type 1)

Model	Dimensions mm (in)															Est. Weight kg (lb)
	W	H	D	D1	D2	W1	W2	H0	H1	H2	H3	H4	t1	t2	d	
2070	220 (8.66)	400 (15.75)	227 (8.94)	139.8 (5.5)	87.2 (3.43)	192 (7.56)	192 (7.56)	348 (13.7)	335 (13.19)	6 (0.24)	52 (2.05)	2 (0.08)	2.3 (0.09)	2.3 (0.09)	M6	9 (19.85)
2082	220 (8.66)	435 (17.13)	227 (8.94)	139.8 (5.5)	87.2 (3.43)	192 (7.56)	192 (7.56)	348 (13.7)	335 (13.19)	6 (0.24)	87 (3.43)	2 (0.08)	2.3 (0.09)	2.3 (0.09)	M6	10.5 (23.15)

Table 10.53 Three-Phase 400 V Class (IP20/UL Type 1)

Model	Dimensions mm (in)															Est. Weight kg (lb)
	W	H	D	D1	D2	W1	W2	H0	H1	H2	H3	H4	t1	t2	d	
4044	220 (8.66)	400 (15.75)	227 (8.94)	139.8 (5.5)	87.2 (3.43)	192 (7.56)	192 (7.56)	348 (13.7)	335 (13.19)	6 (0.24)	52 (2.05)	2 (0.08)	2.3 (0.09)	2.3 (0.09)	M6	9 (19.85)
4060	220 (8.66)	400 (15.75)	246 (9.69)	139.8 (5.5)	106.2 (4.18)	192 (7.56)	192 (7.56)	348 (13.7)	335 (13.19)	6 (0.24)	52 (2.05)	2 (0.08)	2.3 (0.09)	2.3 (0.09)	M6	14 (30.87)

■ 2110, 4075

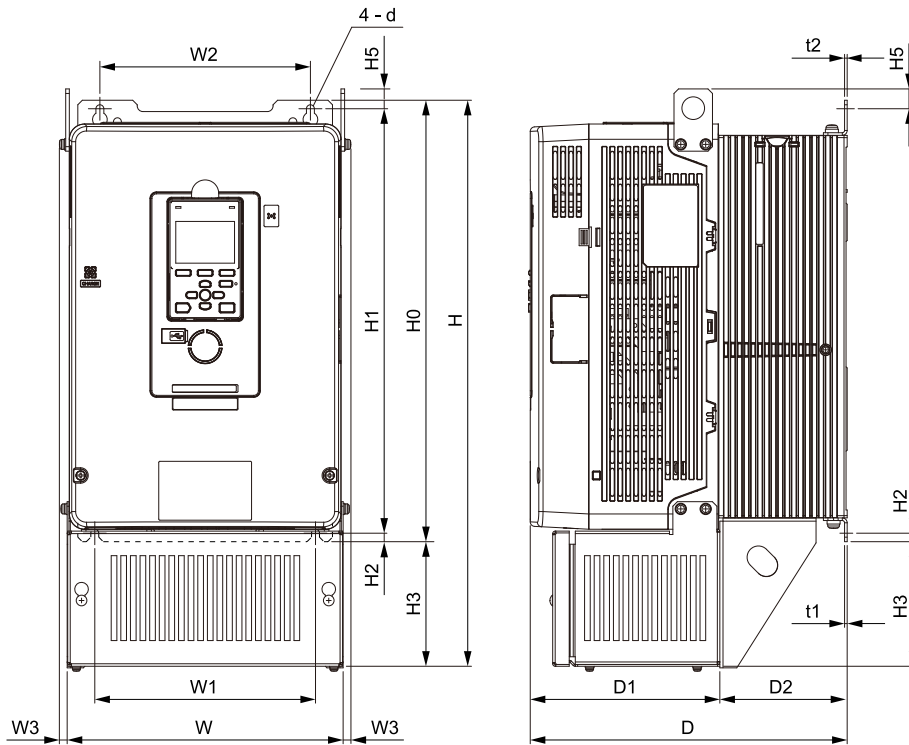

Figure 10.15 Dimension Diagram 4

Table 10.54 Three-Phase 200 V Class (IP20/UL Type 1, No Internal EMC Filter)

Model	Dimensions mm (in)																Est. Weight kg (lb)
	W	H	D	D1	D2	W1	W2	W3	H0	H1	H2	H3	H5	t1	t2	d	
2110	243.8 (9.6)	500 (19.69)	280 (11.02)	167.5 (6.59)	112.5 (4.43)	195 (7.68)	186 (7.32)	6.9 (0.27)	390 (15.35)	375 (14.76)	7.5 (0.3)	110 (4.33)	17.5 (0.69)	2.3 (0.09)	2.3 (0.09)	M6	20 (44.10)

Table 10.55 Three-Phase 200 V Class (IP20/UL Type 1, with Internal EMC Filter)

Model	Dimensions mm (in)																Est. Weight kg (lb)
	W	H	D	D1	D2	W1	W2	W3	H0	H1	H2	H3	H5	t1	t2	d	
2110	243.8 (9.6)	500 (19.69)	280 (11.02)	167.5 (6.59)	112.5 (4.43)	195 (7.68)	186 (7.32)	6.9 (0.27)	390 (15.35)	375 (14.76)	7.5 (0.3)	110 (4.33)	17.5 (0.69)	2.3 (0.09)	2.3 (0.09)	M6	21 (46.31)

Table 10.56 Three-Phase 400 V Class (IP20/UL Type 1)

Model	Dimensions mm (in)																Est. Weight kg (lb)
	W	H	D	D1	D2	W1	W2	W3	H0	H1	H2	H3	H5	t1	t2	d	
4075	243.8 (9.6)	500 (19.69)	280 (11.02)	167.5 (6.59)	112.5 (4.43)	195 (7.68)	186 (7.32)	6.9 (0.27)	390 (15.35)	375 (14.76)	7.5 (0.3)	110 (4.33)	17.5 (0.69)	2.3 (0.09)	2.3 (0.09)	M6	18 (39.69)

■ 2138, 4089, 4103

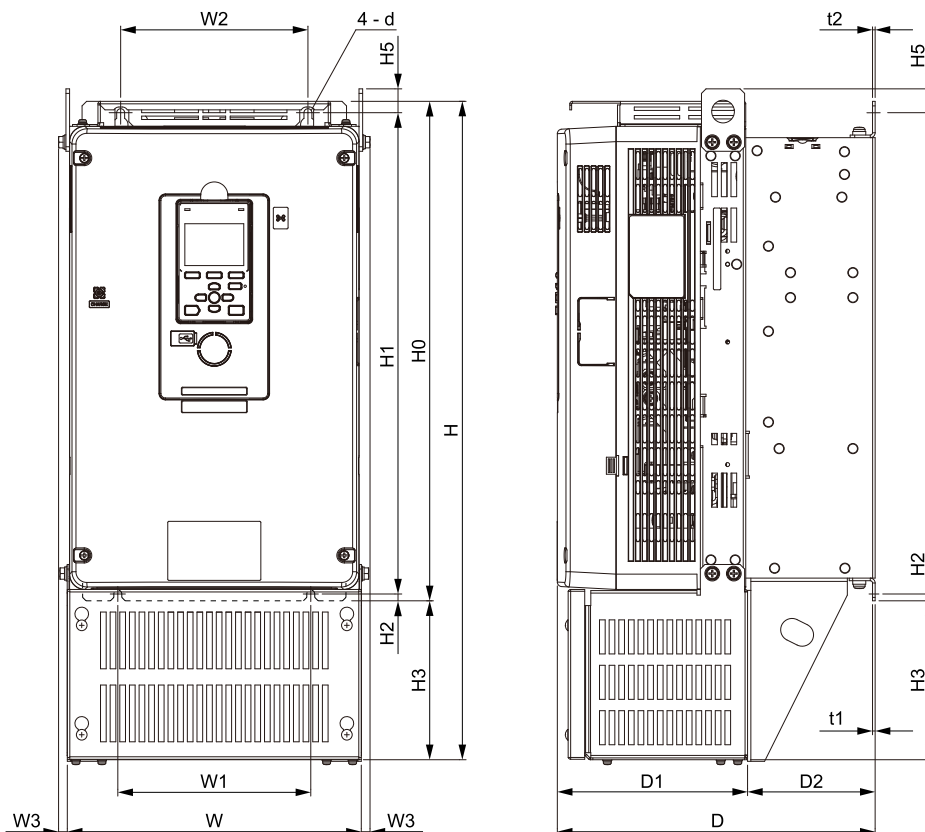

Figure 10.16 Dimension Diagram 5

Table 10.57 Three-Phase 200 V Class (IP20/UL Type 1, No Internal EMC Filter)

Model	Dimensions mm (in)																Est. Weight kg (lb)
	W	H	D	D1	D2	W1	W2	W3	H0	H1	H2	H3	H5	t1	t2	d	
2138	259 (10.20)	580 (22.83)	280 (11.02)	167.6 (6.6)	112.4 (4.43)	170 (6.69)	165 (6.50)	7.7 (0.3)	440 (17.32)	424 (16.69)	6 (0.24)	140 (5.51)	21 (0.83)	2.3 (0.09)	2.3 (0.09)	M6	24 (52.92)

Table 10.58 Three-Phase 200 V Class (IP20/UL Type 1, with Internal EMC Filter)

Model	Dimensions mm (in)																Est. Weight kg (lb)
	W	H	D	D1	D2	W1	W2	W3	H0	H1	H2	H3	H5	t1	t2	d	
2138	259 (10.20)	580 (22.83)	280 (11.02)	167.6 (6.6)	112.4 (4.43)	170 (6.69)	165 (6.50)	7.7 (0.3)	440 (17.32)	424 (16.69)	6 (0.24)	140 (5.51)	21 (0.83)	2.3 (0.09)	2.3 (0.09)	M6	25 (55.13)

Table 10.59 Three-Phase 400 V Class (IP20/UL Type 1, No Internal EMC Filter)

Model	Dimensions mm (in)																Est. Weight kg (lb)
	W	H	D	D1	D2	W1	W2	W3	H0	H1	H2	H3	H5	t1	t2	d	
4089	259 (10.20)	580 (22.83)	280 (11.02)	167.6 (6.6)	112.4 (4.43)	170 (6.69)	165 (6.50)	7.7 (0.3)	440 (17.32)	424 (16.69)	6 (0.24)	140 (5.51)	21 (0.83)	2.3 (0.09)	2.3 (0.09)	M6	23 (50.72)
4103	259 (10.20)	580 (22.83)	280 (11.02)	167.6 (6.6)	112.4 (4.43)	170 (6.69)	165 (6.50)	7.7 (0.3)	440 (17.32)	424 (16.69)	6 (0.24)	140 (5.51)	21 (0.83)	2.3 (0.09)	2.3 (0.09)	M6	28 (61.74)

Table 10.60 Three-Phase 400 V Class (IP20/UL Type 1, with Internal EMC Filter)

Model	Dimensions mm (in)																Est. Weight kg (lb)
	W	H	D	D1	D2	W1	W2	W3	H0	H1	H2	H3	H5	t1	t2	d	
4089	259 (10.20)	580 (22.83)	280 (11.02)	167.6 (6.6)	112.4 (4.43)	170 (6.69)	165 (6.50)	7.7 (0.3)	440 (17.32)	424 (16.69)	6 (0.24)	140 (5.51)	21 (0.83)	2.3 (0.09)	2.3 (0.09)	M6	24 (52.92)
4103	259 (10.20)	580 (22.83)	280 (11.02)	167.6 (6.6)	112.4 (4.43)	170 (6.69)	165 (6.50)	7.7 (0.3)	440 (17.32)	424 (16.69)	6 (0.24)	140 (5.51)	21 (0.83)	2.3 (0.09)	2.3 (0.09)	M6	29 (63.95)

■ 2169, 2211, 4140, 4168

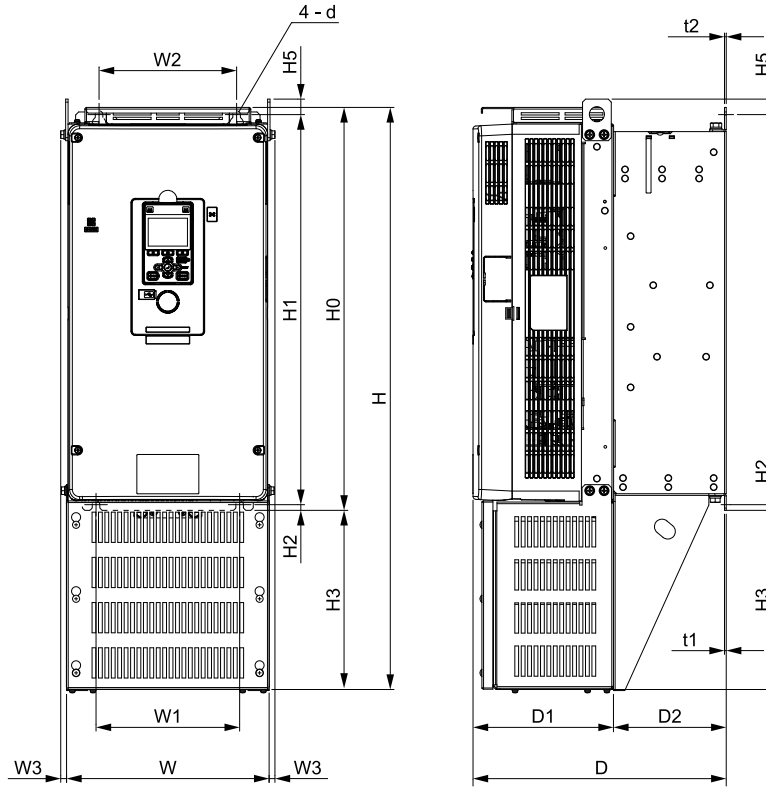

Figure 10.17 Dimension Diagram 6

Table 10.61 Three-Phase 200 V Class (IP20/UL Type 1, No Internal EMC Filter)

Model	Dimensions mm (in)																Est. Weight kg (lb)
	W	H	D	D1	D2	W1	W2	W3	H0	H1	H2	H3	H5	t1	t2	d	
2169	268 (10.55)	700 (27.56)	335 (13.19)	185.8 (7.32)	149.2 (5.87)	190 (7.48)	182 (7.17)	7.7 (0.3)	533 (20.98)	516 (20.31)	7.5 (0.3)	167 (6.57)	20.5 (0.81)	2.3 (0.09)	2.3 (0.09)	M8	39 (86.00)
2211	268 (10.55)	770 (30.31)	335 (13.19)	185.8 (7.32)	149.2 (5.87)	190 (7.48)	182 (7.17)	7.7 (0.3)	533 (20.98)	516 (20.31)	7.5 (0.3)	237 (9.33)	20.5 (0.81)	2.3 (0.09)	2.3 (0.09)	M8	41 (90.41)

Table 10.62 Three-Phase 200 V Class (IP20/UL Type 1, with Internal EMC Filter)

Model	Dimensions mm (in)																Est. Weight kg (lb)
	W	H	D	D1	D2	W1	W2	W3	H0	H1	H2	H3	H5	t1	t2	d	
2169	268 (10.55)	700 (27.56)	335 (13.19)	185.8 (7.32)	149.2 (5.87)	190 (7.48)	182 (7.17)	7.7 (0.3)	533 (20.98)	516 (20.31)	7.5 (0.3)	167 (6.57)	20.5 (0.81)	2.3 (0.09)	2.3 (0.09)	M8	40 (88.20)
2211	268 (10.55)	770 (30.31)	335 (13.19)	185.8 (7.32)	149.2 (5.87)	190 (7.48)	182 (7.17)	7.7 (0.3)	533 (20.98)	516 (20.31)	7.5 (0.3)	237 (9.33)	20.5 (0.81)	2.3 (0.09)	2.3 (0.09)	M8	42 (92.61)

Table 10.63 Three-Phase 400 V Class (IP20/UL Type 1, No Internal EMC Filter)

Model	Dimensions mm (in)																Est. Weight kg (lb)
	W	H	D	D1	D2	W1	W2	W3	H0	H1	H2	H3	H5	t1	t2	d	
4140	268 (10.55)	700 (27.56)	335 (13.19)	185.8 (7.32)	149.2 (5.87)	190 (7.48)	182 (7.17)	7.7 (0.3)	533 (20.98)	516 (20.31)	7.5 (0.3)	167 (6.57)	20.5 (0.81)	2.3 (0.09)	2.3 (0.09)	M8	41 (90.41)
4168	268 (10.55)	700 (27.56)	335 (13.19)	185.8 (7.32)	149.2 (5.87)	190 (7.48)	182 (7.17)	7.7 (0.3)	533 (20.98)	516 (20.31)	7.5 (0.3)	167 (6.57)	20.5 (0.81)	2.3 (0.09)	2.3 (0.09)	M8	42 (92.61)

Table 10.64 Three-Phase 400 V Class (IP20/UL Type 1, with Internal EMC Filter)

Model	Dimensions mm (in)																Est. Weight kg (lb)
	W	H	D	D1	D2	W1	W2	W3	H0	H1	H2	H3	H5	t1	t2	d	
4140	268 (10.55)	700 (27.56)	335 (13.19)	185.8 (7.32)	149.2 (5.87)	190 (7.48)	182 (7.17)	7.7 (0.3)	533 (20.98)	516 (20.31)	7.5 (0.3)	167 (6.57)	20.5 (0.81)	2.3 (0.09)	2.3 (0.09)	M8	42 (92.61)
4168	268 (10.55)	700 (27.56)	335 (13.19)	185.8 (7.32)	149.2 (5.87)	190 (7.48)	182 (7.17)	7.7 (0.3)	533 (20.98)	516 (20.31)	7.5 (0.3)	167 (6.57)	20.5 (0.81)	2.3 (0.09)	2.3 (0.09)	M8	43 (94.82)

■ 2257, 2313, 4208 to 4296

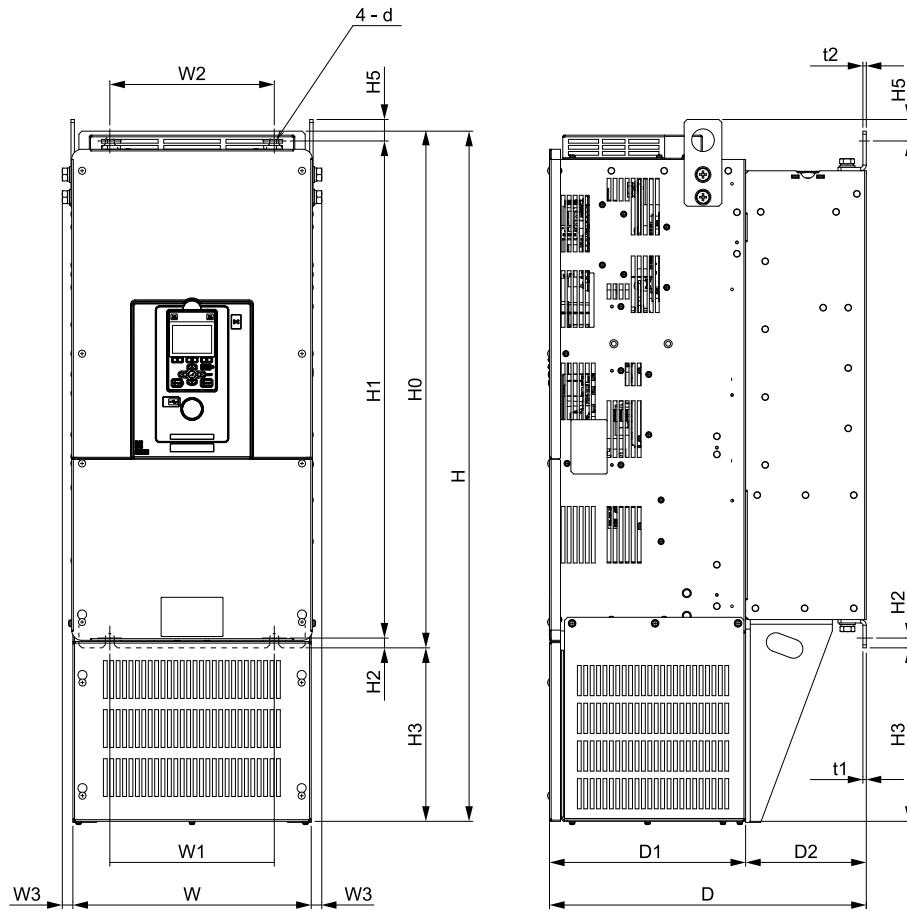

Figure 10.18 Dimension Diagram 7

Table 10.65 Three-Phase 200 V Class (IP20/UL Type 1, No Internal EMC Filter)

Model	Dimensions mm (in)															Est. Weight kg (lb)	
	W	H	D	D1	D2	W1	W2	W3	H0	H1	H2	H3	H5	t1	t2		d
2257	316 (12.44)	915 (36.02)	420 (16.54)	260 (10.24)	160 (6.30)	218 (8.58)	218 (8.58)	14 (0.55)	685 (26.97)	659 (25.94)	13 (0.51)	230 (9.06)	28.5 (1.12)	4.5 (0.18)	4.5 (0.18)	M10	63 (138.92)
2313	316 (12.44)	915 (36.02)	420 (16.54)	260 (10.24)	160 (6.30)	218 (8.58)	218 (8.58)	14 (0.55)	685 (26.97)	659 (25.94)	13 (0.51)	230 (9.06)	28.5 (1.12)	4.5 (0.18)	4.5 (0.18)	M10	66 (145.53)

Table 10.66 Three-Phase 200 V Class (IP20/UL Type 1, with Internal EMC Filter)

Model	Dimensions mm (in)															Est. Weight kg (lb)	
	W	H	D	D1	D2	W1	W2	W3	H0	H1	H2	H3	H5	t1	t2		d
2257	316 (12.44)	915 (36.02)	420 (16.54)	260 (10.24)	160 (6.30)	218 (8.58)	218 (8.58)	14 (0.55)	685 (26.97)	659 (25.94)	13 (0.51)	230 (9.06)	28.5 (1.12)	4.5 (0.18)	4.5 (0.18)	M10	64 (141.12)
2313	316 (12.44)	915 (36.02)	420 (16.54)	260 (10.24)	160 (6.30)	218 (8.58)	218 (8.58)	14 (0.55)	685 (26.97)	659 (25.94)	13 (0.51)	230 (9.06)	28.5 (1.12)	4.5 (0.18)	4.5 (0.18)	M10	66 (145.53)

10.7 Drive Exterior and Mounting Dimensions

Table 10.67 Three-Phase 400 V Class (IP20/UL Type 1, No Internal EMC Filter)

Model	Dimensions mm (in)																Est. Weight kg (lb)
	W	H	D	D1	D2	W1	W2	W3	H0	H1	H2	H3	H5	t1	t2	d	
4208	316 (12.44)	915 (36.02)	420 (16.54)	260 (10.24)	160 (6.30)	218 (8.58)	218 (8.58)	14 (0.55)	685 (26.97)	659 (25.94)	13 (0.51)	230 (9.06)	28.5 (1.12)	4.5 (0.18)	4.5 (0.18)	M10	65 (143.33)
4250	316 (12.44)	915 (36.02)	420 (16.54)	260 (10.24)	160 (6.30)	218 (8.58)	218 (8.58)	14 (0.55)	685 (26.97)	659 (25.94)	13 (0.51)	230 (9.06)	28.5 (1.12)	4.5 (0.18)	4.5 (0.18)	M10	67 (147.74)
4296	316 (12.44)	915 (36.02)	420 (16.54)	260 (10.24)	160 (6.30)	218 (8.58)	218 (8.58)	14 (0.55)	685 (26.97)	659 (25.94)	13 (0.51)	230 (9.06)	28.5 (1.12)	4.5 (0.18)	4.5 (0.18)	M10	70 (154.35)

Table 10.68 Three-Phase 400 V Class (IP20/UL Type 1, with Internal EMC Filter)

Model	Dimensions mm (in)																Est. Weight kg (lb)
	W	H	D	D1	D2	W1	W2	W3	H0	H1	H2	H3	H5	t1	t2	d	
4208	316 (12.44)	915 (36.02)	420 (16.54)	260 (10.24)	160 (6.30)	218 (8.58)	218 (8.58)	14 (0.55)	685 (26.97)	659 (25.94)	13 (0.51)	230 (9.06)	28.5 (1.12)	4.5 (0.18)	4.5 (0.18)	M10	66 (145.53)
4250	316 (12.44)	915 (36.02)	420 (16.54)	260 (10.24)	160 (6.30)	218 (8.58)	218 (8.58)	14 (0.55)	685 (26.97)	659 (25.94)	13 (0.51)	230 (9.06)	28.5 (1.12)	4.5 (0.18)	4.5 (0.18)	M10	68 (149.94)
4296	316 (12.44)	915 (36.02)	420 (16.54)	260 (10.24)	160 (6.30)	218 (8.58)	218 (8.58)	14 (0.55)	685 (26.97)	659 (25.94)	13 (0.51)	230 (9.06)	28.5 (1.12)	4.5 (0.18)	4.5 (0.18)	M10	71 (156.56)

■ 2360, 4371

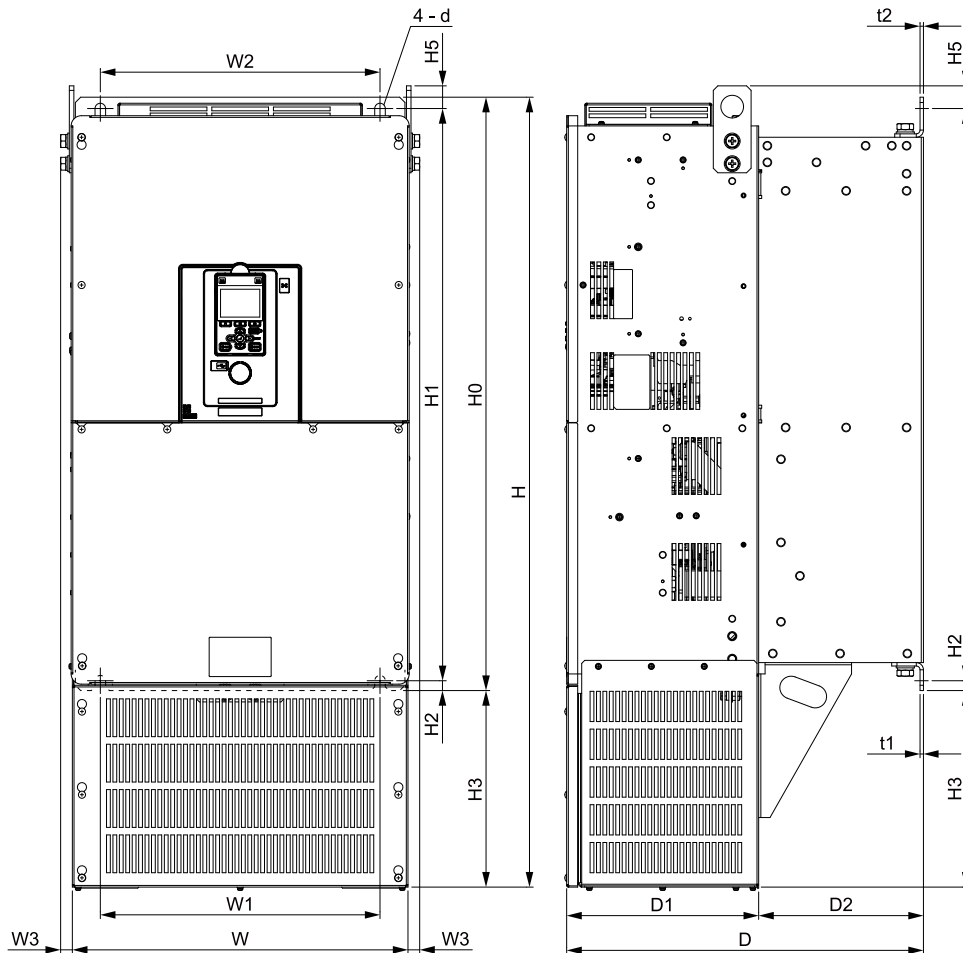

Figure 10.19 Dimension Diagram 8

Table 10.69 Three-Phase 200 V Class (IP20/UL Type 1, No Internal EMC Filter)

Model	Dimensions mm (in)																Est. Weight kg (lb)
	W	H	D	D1	D2	W1	W2	W3	H0	H1	H2	H3	H5	t1	t2	d	
2360	444 (17.48)	1045 (41.14)	472 (18.58)	254 (10.00)	218 (8.58)	370 (14.57)	370 (14.57)	15.5 (0.61)	785 (30.91)	757 (29.80)	13 (0.51)	260 (10.24)	30 (1.18)	4.5 (0.18)	4.5 (0.18)	M12	109 (240.35)

Table 10.70 Three-Phase 200 V Class (IP20/UL Type 1, with Internal EMC Filter)

Model	Dimensions mm (in)																Est. Weight kg (lb)
	W	H	D	D1	D2	W1	W2	W3	H0	H1	H2	H3	H5	t1	t2	d	
2360	444 (17.48)	1045 (41.14)	472 (18.58)	254 (10.00)	218 (8.58)	370 (14.57)	370 (14.57)	15.5 (0.61)	785 (30.91)	757 (29.80)	13 (0.51)	260 (10.24)	30 (1.18)	4.5 (0.18)	4.5 (0.18)	M12	115 (253.58)

Table 10.71 Three-Phase 400 V Class (IP20/UL Type 1, No Internal EMC Filter)

Model	Dimensions mm (in)																Est. Weight kg (lb)
	W	H	D	D1	D2	W1	W2	W3	H0	H1	H2	H3	H5	t1	t2	d	
4371	444 (17.48)	1045 (41.14)	472 (18.58)	254 (10.00)	218 (8.58)	370 (14.57)	370 (14.57)	15.5 (0.61)	785 (30.91)	757 (29.80)	13 (0.51)	260 (10.24)	30 (1.18)	4.5 (0.18)	4.5 (0.18)	M12	114 (251.37)

Table 10.72 Three-Phase 400 V Class (IP20/UL Type 1, with Internal EMC Filter)

Model	Dimensions mm (in)																Est. Weight kg (lb)
	W	H	D	D1	D2	W1	W2	W3	H0	H1	H2	H3	H5	t1	t2	d	
4371	444 (17.48)	1045 (41.14)	472 (18.58)	254 (10.00)	218 (8.58)	370 (14.57)	370 (14.57)	15.5 (0.61)	785 (30.91)	757 (29.80)	13 (0.51)	260 (10.24)	30 (1.18)	4.5 (0.18)	4.5 (0.18)	M12	119 (262.40)

10.8 Knock-Out Hole Dimensions (IP20/UL Type 1)

◆ Models and Dimensions of Knock-Out Hole

Model	Reference
2004 to 2042 4002 to 4023	496
2056 4031, 4038	497
2070, 2082 4044, 4060	497
2110 4075	498
2138 4089, 4103	498
2169 4140, 4168	499
2211	499
2257, 2313 4208 - 4296	500
2360 4371	500

■ 2004 - 2042, 4002 - 4023

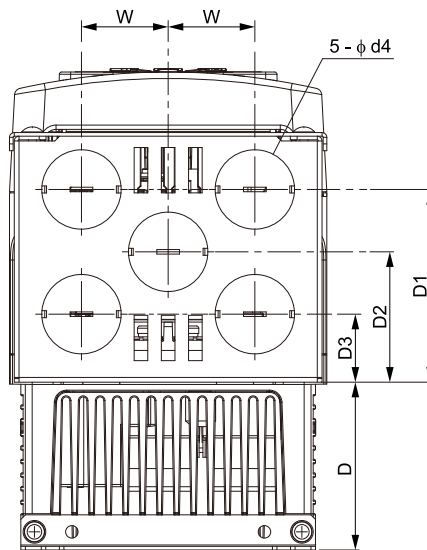

Figure 10.20 Knock-Out Dimension Diagram 1 (Models: 2004 to 2042 and 4002 to 4023)

Model	Dimensions mm (in)					
	D	D1	D2	D3	W	φd4
2004 to 2012 4002 to 4005	39 (1.54)	85 (3.35)	57.5 (2.26)	30 (1.18)	38.3 (1.51)	35 (1.38)
2018 to 2042 4007 to 4023	74 (2.91)	85 (3.35)	57.5 (2.26)	30 (1.18)	38.3 (1.51)	35 (1.38)

■ 2056, 4031, 4038

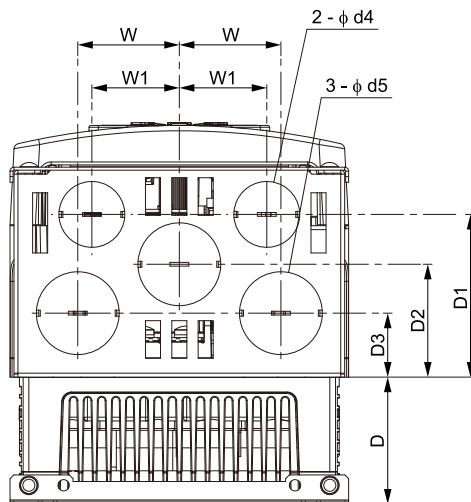

Figure 10.21 Knock-Out Dimension Diagram 2 (Models: 2056, 4031, and 4038)

Model	Dimensions mm (in)							
	D	D1	D2	D3	W	W1	φd4	φd5
2056	67.5	86.5	60	34	54	46.5	35	44
4031, 4038	(2.66)	(3.41)	(2.36)	(1.34)	(2.13)	(1.83)	(1.38)	(1.73)

■ 2070, 2082, 4044, 4060

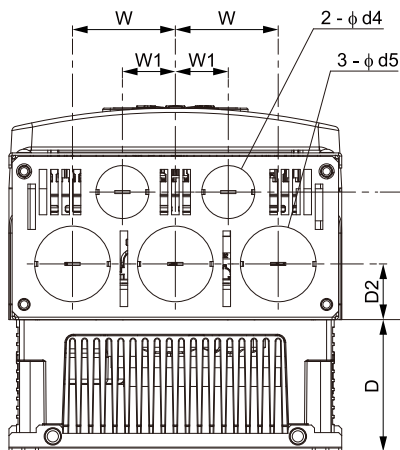

Figure 10.22 Knock-Out Dimension Diagram 3 (Models: 2070, 2082, 4044, and 4060)

Model	Dimensions mm (in)							
	D	D1	D2	W	W1	φd4	φd5	
2070, 2082	87.2	84.3	36.8	68	35	35	50	
4044	(3.43)	(3.32)	(1.45)	(2.68)	(1.38)	(1.38)	(1.97)	
4060	106.2	84.3	36.8	68	35	35	50	
	(4.18)	(3.32)	(1.45)	(2.68)	(1.38)	(1.38)	(1.97)	

■ 2110, 4075

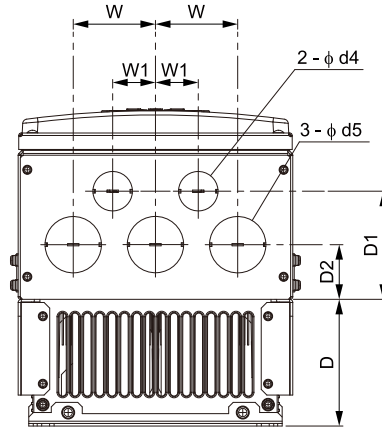

Figure 10.23 Knock-Out Dimension Diagram 4 (Models: 2110 and 4075)

Model	Dimensions mm (in)						
	D	D1	D2	W	W1	φd4	φd5
2110	112.5	96	48.5	73	38	35	50
4075	(4.43)	(3.78)	(1.91)	(2.87)	(1.50)	(1.38)	(1.97)

■ 2138, 4089, 4103

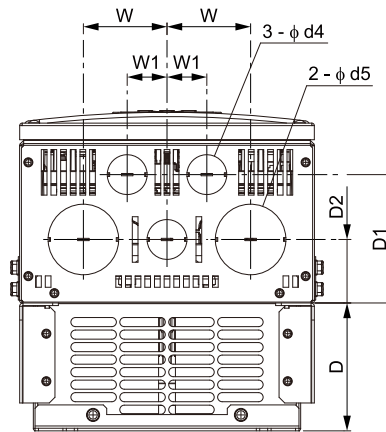

Figure 10.24 Knock-Out Dimension Diagram 5 (Models: 2138, 4089, and 4103)

Model	Dimensions mm (in)						
	D	D1	D2	W	W1	φd4	φd5
2138	112.4	112.8	55.8	73.5	35	35	62
4089, 4103	(4.43)	(4.44)	(2.20)	(2.89)	(1.38)	(1.38)	(2.44)

■ 2169, 4140, 4168

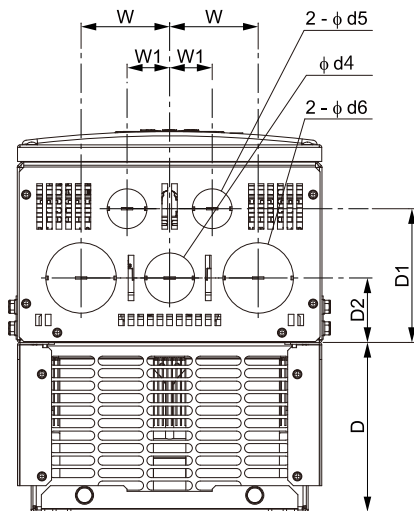

Figure 10.25 Knock-Out Dimension Diagram 6 (Models: 2169, 4140, and 4168)

Model	Dimensions mm (in)							
	D	D1	D2	W	W1	φd4	φd5	φd6
2169	149.2	117.8	56.8	78	37.5	44	35	62
4140, 4168	(5.87)	(4.64)	(2.24)	(3.07)	(1.48)	(1.73)	(1.38)	(2.44)

■ 2211

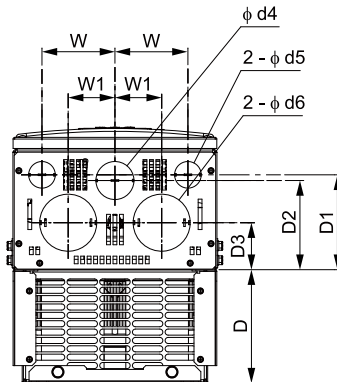

Figure 10.26 Knock-Out Dimension Diagram 7 (Models: 2211)

Model	Dimensions mm (in)								
	D	D1	D2	D3	W	W1	φd4	φd5	φd6
2211	149.2	124.8	117.3	61.8	96	61.5	50	35	75
	(5.87)	(4.91)	(4.62)	(2.43)	(3.78)	(2.42)	(1.97)	(1.38)	(2.95)

■ 2257, 2313, 4208 to 4296

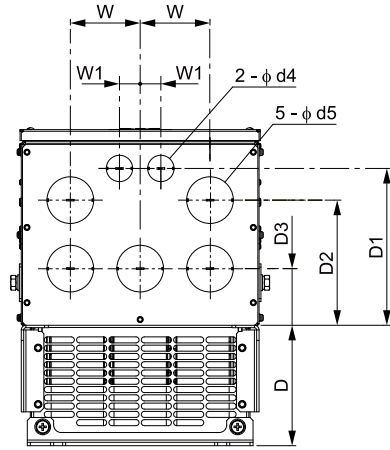

Figure 10.27 Knock-Out Dimension Diagram 8 (Models: 2257, 2313, 4208, 4250, and 4296)

Model	Dimensions mm (in)							
	D	D1	D2	D3	W	W1	φd4	φd5
2257, 2313	160	208.4	166.3	75.3	92.8	27.5	35	62
4208, 4250, 4296	(6.30)	(8.20)	(6.55)	(2.96)	(3.65)	(1.08)	(1.38)	(2.44)

■ 2360, 4371

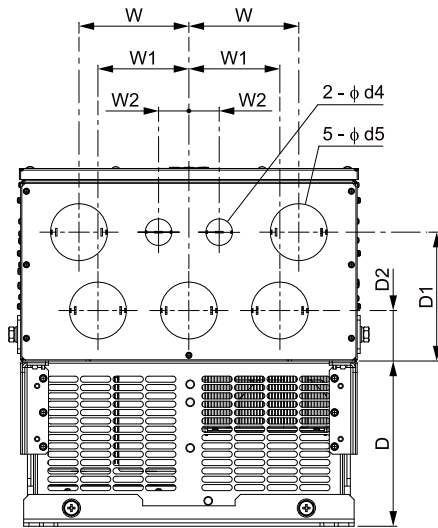

Figure 10.28 Knock-Out Dimension Diagram 9 (Models: 2360 and 4371)

Model	Dimensions mm (in)							
	D	D1	D2	W	W1	W2	φd4	φd5
2360	218	170	66.6	145	120	40	35	75
4371	(8.58)	(6.69)	(2.62)	(5.71)	(4.72)	(1.57)	(1.38)	(2.95)

10.9 Peripheral Devices and Options

to [Table 10.77](#) show the available peripheral devices and options for the drive. Contact Yaskawa or your nearest sales representative to make an order.

- Selection: Refer to the drive catalog for information about available products.
- Installation and wiring: Refer to the instruction manual for each option.

Table 10.73 Main Circuit Options

Name	Model	Intended Use
AC reactor	LR3 series and ALR3 series	To improve the drive input power factor. <ul style="list-style-type: none"> • To prevent damage to the drive when the power supply capacity is large. You must only use this option when the power supply capacity is more than 600 kVA. • To decrease harmonic current. • To improve the power supply total power factor.
Braking Resistor	ERF-150WJ Series	To decrease the regenerative energy of the motor and decrease the deceleration time (duty cycle of 3% ED). You must also use the installation attachment.
Braking Unit	CDBR series	Use with a braking resistor unit to decrease motor deceleration times.
Residual Current Monitoring/ Detection (RCM/RCD)	NV and NS series	To prevent short circuit damage to the power supply system, provide overload protection for wiring, prevent electrical shock, and provide ground fault protection against earth leakage fires.
Molded-Case Circuit Breaker (MCCB)	NF Series	To prevent short circuit damage to the power supply system and provide overload protection for wiring.
Input Side Magnetic Contactor (MC)	SC Series	To prevent burn damage when connecting a braking resistor. This option fully opens the circuit between the power supply and drive.

Table 10.74 Keypad

Name	Model	Intended Use
Keypad Remote Cable	1 m: WV001 3 m: WV003	To connect the keypad and drive. This option is an RJ-45, 8-pin straight-through UTP CAT5e cable.
Installation Support Set A	900-192-933-001	To attach the keypad to the control panel. This option uses screws.
Installation Support Set B	900-192-933-002	To attach the keypad to the control panel. This option uses nut clamps. Use this option when there are weld studs in the control panel.

Table 10.75 Kit

Name	Model	Intended Use
External Heatsink Installation Kit	900-193-209-001 900-193-209-002 900-193-209-003	To install the heatsink outside of the control panel. <ul style="list-style-type: none"> • 900-193-209-001: 2004 to 2042, 4002 to 4023 • 900-193-209-002: 2056, 4031, 4038 • 900-193-209-003: 2070, 2082, 4044, 4060
External Heatsink Installation Kit	ZPSD-700-EH12-FR12	To install the heatsink of drive models 4810 to 4H12 outside of the enclosure panel with water-proof and dust-proof specifications (IP55/UL Type 12).
UL Type 1 Kit	900-192-121-001 900-192-121-002 900-192-121-003 900-192-121-004 900-192-121-005 900-192-121-006 900-192-121-007 900-192-121-008 900-192-121-009 900-192-121-010	To change an IP20/UL Open Type drive to an IP20/UL Type 1 drive. <ul style="list-style-type: none"> • 900-192-121-001: 2004 to 2042, 4002 to 4023 • 900-192-121-002: 2056, 4031, 4038 • 900-192-121-003: 2070, 4044, 4060 • 900-192-121-004: 2082 • 900-192-121-005: 2110, 4075 • 900-192-121-006: 2138, 4089, 4103 • 900-192-121-007: 2169, 4140, 4168 • 900-192-121-008: 2211 • 900-192-121-009: 2257, 2313, 4208 to 4296 • 900-192-121-010: 2360, 4371

Table 10.76 Engineering Tools

Name	Model	Intended Use
DriveWizard	-	To use a PC to program drives and manage parameters.
DriveWorksEZ	-	To use a PC to do advanced drive programming.

Table 10.77 Option

Name	Model	Intended Use	Document No.
Complementary Type PG	PG-B3	<p>This option is for use with CL-V/f and OLV control methods. The drive detects motor rotation speed from the pulse generator as feedback and can control the drive output frequency to keep the motor speed constant.</p> <ul style="list-style-type: none"> Complementary output PG support A, B, and Z pulse (Three-phase pulse) input Maximum input frequency: 50 kHz Pulse monitor output: Open-collector (24 V, maximum of 30 mA) Encoder power supply: 12 V, maximum 200 mA current. 	TOBPC73060075
Motor PG feedback line driver interface	PG-X3	<p>This option is for use with CLV, CL-V/f, and CLV/PM control methods. The drive detects motor rotation speed from the pulse generator as feedback. The drive can then enable control of the output frequency keep a constant motor speed.</p> <ul style="list-style-type: none"> RS-422 output encoder support A, B, and Z pulse (differential pulse) input Maximum input frequency: 300 kHz Pulse monitor: Equivalent to RS-422 level Encoder voltage output: 5 V or 12V, maximum 200 mA current 	TOBPC73060076
Encoder Type (EnDat)	PG-F3	<p>This option is for use with CLV/PM control method. The drive detects motor rotation speed from the pulse generator as feedback. The drive can then enable control of the output frequency keep a constant motor speed.</p> <ul style="list-style-type: none"> Supports EnDat 2.1/01, EnDat 2.2/01, EnDat 2.2/22 models from HEIDENHAIN Supports HIPERFACE models from SICK STEGMANN Maximum input frequency: 20 kHz (use for low-speed applications, for example gearless motors) <p>Note: EnDat 2.2/22 has no limits on input frequencies.</p> <ul style="list-style-type: none"> Cable length: Maximum of 20 m (65.6 ft) for encoders and maximum of 30 m (98.4 ft) for pulse monitors Pulse monitor: Equivalent to RS-422 level <p>Note: You cannot use EnDat 2.2/22.</p> <ul style="list-style-type: none"> Encoder voltage output: 5 V at a maximum current of 330 mA, or 8 V at a maximum current of 150 mA <p>Note: Use these types of encoder cables:</p> <ul style="list-style-type: none"> EnDat 2.1/01 and EnDat 2.2/01: HEIDENHAIN 17-pin cables EnDat 2.2/22: HEIDENHAIN 8-pin cables HIPERFACE: SICK STEGMANN 8-pin cables 	TOBPC73060077
Resolver Interface	PG-RT3	<p>To connect resolvers that are electrically compatible with resolver model TS2640N321E64 from Tamagawa Seiki Co., Ltd. These are the typical electrical characteristics of model TS2640N321E64:</p> <ul style="list-style-type: none"> Resolver motor excitation voltage: 10 Vac rms at 10 kHz Transformation ratio [K]: 0.5 ±5% Resolver input current: 100 mA rms Cable length: Up to 10 m (32.8 ft) (or up to 100 m [328 ft] when using SS5 or SS7 series motors from Yaskawa Motor Co., Ltd. and encoder cables from Yaskawa Controls Co., Ltd.) <p>This option is for use with CLV and CLV/PM control methods.</p>	TOBPC73060087
Analog input	AI-A3	<p>To configure very accurate analog references at high resolution.</p> <ul style="list-style-type: none"> Input signal level: -10 Vdc to +10 Vdc (20 kΩ) at 4 mA to 20 mA (250 Ω) Input channel: 3 channels Use a DIP switch to select voltage input or current input. Input resolution <ul style="list-style-type: none"> Voltage input: 13 bits (1/8192) + encoding Current input: 1/4096 	TOBPC73060078
Analog Monitor	AO-A3	<p>To use analog signals to monitor the drive output frequency and output current.</p> <ul style="list-style-type: none"> Output resolution: 11 bits (1/2048) + encoding Output voltage: -10 Vdc to +10 Vdc (non-insulated) Output channels: 2 channels 	TOBPC73060079
Digital input	DI-A3	<p>To use digital speed references and MFDI with a maximum 16 bits of resolution.</p> <ul style="list-style-type: none"> Input signals: Binary, 16 bits: BCD4 digits + SIGN signal + SET signal Use parameters to select 6 bits, 8 bits, or 12 bits. Input voltage: 24 V (insulated) Input current: 8 mA 	TOBPC73060080
Digital Output	DO-A3	<p>To output insulated digital signals and monitor the operation status of the drive (alarm signals and detecting zero speed).</p> <p>Type of output:</p> <ul style="list-style-type: none"> Photocoupler relays: 6 channels (48 V, 50 mA maximum) Relay contact output: 2 channels (250 Vac at 1 A or less, 30 Vdc at 1 A or less) 	TOBPC73060081

Name	Model	Intended Use	Document No.
PROFIBUS-DP	SI-P3	This option uses the host controller over PROFIBUS-DP communication to: <ul style="list-style-type: none"> Operate and stop the drive Set and view parameters Monitor output frequency, output current, and other statuses 	TOBPC73060082 SIXPC73060082
CC-Link	SI-C3	This option uses the host controller over CC-Link communication to: <ul style="list-style-type: none"> Operate and stop the drive Set and view parameters Monitor output frequency, output current, and other statuses 	TOBPC73060083 SIXPC73060083
DeviceNet	SI-N3	This option uses the host controller over DeviceNet communication to: <ul style="list-style-type: none"> Operate and stop the drive Set and view parameters Monitor output frequency, output current, and other statuses Note: The drive is compatible with option software versions 1114 and later.	TOBPC73060084 SIXPC73060084
CANopen	SI-S3	This option uses the host controller over CANopen communication to: <ul style="list-style-type: none"> Operate and stop the drive Set and view parameters Monitor output frequency, output current, and other statuses 	TOBPC73060085 SIXPC73060085
MECHATROLINK-II	SI-T3	This option uses the host controller over MECHATROLINK-II communication to: <ul style="list-style-type: none"> Operate and stop the drive Set and view parameters Monitor output frequency, output current, and other statuses Note: The drive is compatible with option software versions 6108 and later.	TOBPC73060086 SIXPC73060086
MECHATROLINK-III	SI-ET3	This option uses the host controller over MECHATROLINK-III communication to: <ul style="list-style-type: none"> Operate and stop the drive Set and view parameters Monitor output frequency, output current, and other statuses Note: The drive is compatible with option software versions 6202 and later.	TOBPC73060088 SIXPC73060088
EtherNet/IP	SI-EN3	This option uses the host controller over EtherNet/IP communication to: <ul style="list-style-type: none"> Operate and stop the drive Set and view parameters Monitor output frequency, output current, and other statuses 	TOBPC73060092 SIEPC73060092
	JOHB-SMP3		TOBPC7306000H SIXPC7306000J
Modbus TCP/IP	SI-EM3	This option uses the host controller over Modbus TCP/IP communication to: <ul style="list-style-type: none"> Operate and stop the drive Set and view parameters Monitor output frequency, output current, and other statuses 	TOBPC73060091 SIEPC73060091
	JOHB-SMP3		TOBPC7306000H SIXPC7306000I
LonWorks	SI-W3	This option uses the host controller over LonWorks communication to: <ul style="list-style-type: none"> Operate and stop the drive Set and view parameters Monitor output frequency, output current, and other statuses 	TOBPC73060093 SIEPC73060093
PROFINET	SI-EP3	This option uses the host controller over PROFINET communication to: <ul style="list-style-type: none"> Operate and stop the drive Set and view parameters Monitor output frequency, output current, and other statuses 	TOBPC73060089 SIXPC73060089
	JOHB-SMP3		TOBPC7306000H SIXPC7306000K
EtherCAT	SI-ES3	This option uses the host controller over EtherCAT communication to: <ul style="list-style-type: none"> Operate and stop the drive Set and view parameters Monitor output frequency, output current, and other statuses 	TOBPC73060096 SIXPC73060096
	JOHB-SMP3		TOBPC7306000H SIXPC7306000L

Table 10.78 Types of Option and Connectors

Option	Available Connector Ports	Number of Options Permitted
PG-B3, PG-X3	CN5-C (CN5-B)	2 ^{*1}
PG-F3 ^{*2} , PG-RT3 ^{*2}	CN5-C	1
AO-A3, DO-A3	CN5-A, B, and C	1
AI-A3 ^{*3} , DI-A3 ^{*3} , SI-C3, SI-EL3, SI-EM3, SI-EN3, SI-EP3, SI-ES3, SI-ET3, SI-N3, SI-P3, SI-S3, SI-T3, SI-W3, JOHB-SMP3	CN5-A	1

*1 To connect only one PG option, use the CN5-C connector. To connect two PG options, use the CN5-C and CN5-B connectors.

*2 If you use the motor switching function, you cannot use this option.

10.9 Peripheral Devices and Options

- *3 To use AI-A3 and DI-A3 input statuses as monitors, connect the options to one of CN5-A, CN5-B, or CN5-C. Use U1-21, U1-22, and U1-23 to confirm the AI-A3 input status. Use U1-17 to confirm the DI-A3 input status.

Parameter List

11.1	Section Safety	506
11.2	How to Read the Parameter List	507
11.3	Parameter Groups	508
11.4	A: Initialization Parameters	509
11.5	b: Application	513
11.6	C: Tuning	524
11.7	d: Reference Settings	530
11.8	E: Motor Parameters	535
11.9	F: Options	540
11.10	H: Terminal Functions	554
11.11	L: Protection Functions	581
11.12	n: Special Adjustment	591
11.13	o: Keypad-Related Settings	598
11.14	q: DriveWorksEZ Parameters	605
11.15	r: DWEZ Connection 1-20	606
11.16	T: Motor Tuning	607
11.17	U: Monitors	611
11.18	Parameters that Change from the Default Settings with A1-02 [Control Method Selection]	627
11.19	Parameters that Change from the Default Settings with E3-01 [Motor 2 Control Mode Selection]	633
11.20	Parameters Changed by E1-03 [V/f Pattern Selection]	634
11.21	Defaults by Drive Model and Duty Rating ND/HD	637

11.1 Section Safety









 **DANGER**

Do not ignore the safety messages in this manual.

If you ignore the safety messages in this manual, it will cause serious injury or death. The manufacturer is not responsible for injuries or damage to equipment.

11.2 How to Read the Parameter List

◆ Icons and Terms that Identify Parameters and Control Methods

Icon	Description
	The parameter is available when operating the drive with V/f Control.
	The parameter is available when operating the drive with Closed Loop V/f Control.
	The parameter is available when operating the drive with Open Loop Vector Control.
	The parameter is available when operating the drive with Closed Loop Vector Control.
	The parameter is available when operating the drive with Advanced Open Loop Vector Control.
	The parameter is available when operating the drive with Open Loop Vector Control for PM.
	The parameter is available when operating the drive with Advanced Open Loop Vector Control for PM.
	The parameter is available when operating the drive with Closed Loop Vector Control for PM.
	The parameter is available when operating the drive with EZ Open Loop Vector Control.
Hex.	Hexadecimal numbers that represent MEMOBUS addresses to change parameters over network communication.
RUN	You can change the parameter setting during Run.
Expert	The parameter that is available in Expert Mode only. ^{*1}

*1 Set $A1-01 = 3$ [*Access Level Selection = Expert Level*] to show and set Expert Mode parameters on the keypad.

Note:

Gray icons identify parameters that are not available in the specified control method.

11.3 Parameter Groups

Represents the type of product parameters.

Parameters	Name
A1	Initialization
A2	User Parameters
b1	Operation Mode Selection
b2	DC Injection Braking and Short Circuit Braking
b3	Speed Search
b4	Timer Function
b5	PID Control
b6	Dwell Function
b7	Droop Control
b8	Energy Saving
b9	Zero Servo
C1	Accel & Decel Time
C2	S-Curve Characteristics
C3	Slip Compensation
C4	Torque Compensation
C5	Auto Speed Regulator (ASR)
C6	Duty & Carrier Frequency
d1	Frequency Reference
d2	Reference Limits
d3	Jump Frequency
d4	Frequency Ref Up/Down & Hold
d5	Torque Control
d6	Field Weakening /Forcing
d7	Offset Frequency
E1	V/f Pattern for Motor 1
E2	Motor Parameters
E3	V/f Pattern for Motor 2
E4	Motor 2 Parameters
E5	PM Motor Settings
E9	Motor Setting
F1	PG Option Setup (Encoder)
F2	Analog Input Option
F3	Digital Input Option
F4	Analog Output Option
F5	Digital Output Option
F6	Communication Options
F7	Ethernet Options
H1	Digital Inputs
H2	Digital Outputs
H3	Analog Inputs

Parameters	Name
H4	Analog Outputs
H5	Modbus Communication
H6	Pulse Train Input/Output
H7	Virtual Inputs / Outputs
L1	Motor Protection
L2	Power Loss Ride Through
L3	Stall Prevention
L4	Speed Detection
L5	Fault Restart
L6	Torque Detection
L7	Torque Limit
L8	Drive Protection
L9	Drive Protection 2
n1	Hunting Prevention
n2	Auto Freq Regulator (AFR)
n3	High Slip/Overexcite Braking
n4	Adv Open Loop Vector Tune
n5	Feed Forward Control
n6	Online Tuning
n7	EZ Drive
n8	PM Motor Control Tuning
o1	Keypad Display
o2	Keypad Operation
o3	Copy Keypad Function
o4	Maintenance Monitors
o5	Log Function
q	DriveWorksEZ Parameters
r	DriveWorksEZ Connections
T0	Tuning Mode Selection
T1	InductionMotor Auto-Tuning
T2	PM Motor Auto-Tuning
T3	ASR and Inertia Tuning
T4	EZ Tuning
U1	Operation Status Monitors
U2	Fault Trace
U3	Fault History
U4	Maintenance Monitors
U5	PID Monitors
U6	Operation Status Monitors
U8	DriveWorksEZ Monitors

11.4 A: Initialization Parameters

◆ A1: Initialization

No. (Hex.)	Name	Description	Default (Range)	Ref.
A1-00 (0100) RUN	Language Selection	<p>V/f CL-V/f OLV CLV AOLV OLV/PM AOLV/PM CLV/PM EZOLV</p> <p>Sets the language for the LCD keypad.</p> <p>Note: When you use <i>A1-03 [Initialize Parameters]</i> to initialize the drive, the drive will not reset this parameter.</p> <p>0 : English 1 : Japanese 2 : German 3 : French 4 : Italian 5 : Spanish 6 : Portuguese 7 : Chinese 8 : Czech 9 : Russian 10 : Turkish 11 : Polish 12 : Greek</p>	0 (0 - 12)	659
A1-01 (0101) RUN	Access Level Selection	<p>V/f CL-V/f OLV CLV AOLV OLV/PM AOLV/PM CLV/PM EZOLV</p> <p>Sets user access to parameters. The access level controls which parameters the keypad will display, and which parameters the user can set.</p> <p>0 : Operation Only 1 : User Parameters 2 : Advanced Level 3 : Expert Level</p>	2 (0 - 3)	659
A1-02 (0102)	Control Method Selection	<p>V/f CL-V/f OLV CLV AOLV OLV/PM AOLV/PM CLV/PM EZOLV</p> <p>Sets the control method for the drive application and the motor.</p> <p>0 : V/f Control 1 : V/f Control with Encoder 2 : Open Loop Vector 3 : Closed Loop Vector 4 : Advanced Open Loop Vector 5 : PM Open Loop Vector 6 : PM Advanced Open Loop Vector 7 : PM Closed Loop Vector 8 : EZ Vector Control</p>	2 (0 - 8)	660
A1-03 (0103)	Initialize Parameters	<p>V/f CL-V/f OLV CLV AOLV OLV/PM AOLV/PM CLV/PM EZOLV</p> <p>Sets parameters to default values.</p> <p>0 : No Initialization 1110 : User Initialization 2220 : 2-Wire Initialization 3330 : 3-Wire Initialization</p>	0 (0 - 3330)	661
A1-04 (0104)	Password	<p>V/f CL-V/f OLV CLV AOLV OLV/PM AOLV/PM CLV/PM EZOLV</p> <p>Entry point for the password set in <i>A1-05 [Password Setting]</i>. The user can view the settings of parameters that are locked without entering the password. Enter the correct password in this parameter to change parameter settings.</p>	0000 (0000 - 9999)	662
A1-05 (0105)	Password Setting	<p>V/f CL-V/f OLV CLV AOLV OLV/PM AOLV/PM CLV/PM EZOLV</p> <p>Set the password to lock parameters and prevent changes to parameter settings. Enter the correct password in <i>A1-04 [Password]</i> to unlock parameters and accept changes.</p>	0000 (0000 - 9999)	663
A1-06 (0127)	Application Preset	<p>V/f CL-V/f OLV CLV AOLV OLV/PM AOLV/PM CLV/PM EZOLV</p> <p>Sets the drive to operate in selected application conditions.</p> <p>0 : General-purpose 1 : Water Supply Pump 2 2 : Conveyor 3 : Exhaust Fan 4 : HVAC Fan 5 : Air Compressor 6 : Crane (Hoist) 7 : Crane (Traveling)</p>	0 (0 - 7)	663

11.4 A: Initialization Parameters

No. (Hex.)	Name	Description	Default (Range)	Ref.
A1-07 (0128)	DriveWorksEZ Function Selection	<p>V/f CL-V/f OLV CLV AOLV OLV/PM AOLV/PM CLV/PM EZOLV</p> <p>Sets the drive to operate with DriveWorksEZ. 0 : DWEZ Disabled 1 : DWEZ Enabled 2 : Enabled/Disabled wDigital Input</p>	0 (0 - 2)	678
A1-11 (111D) Expert	Firmware Update Lock	<p>V/f CL-V/f OLV CLV AOLV OLV/PM AOLV/PM CLV/PM EZOLV</p> <p>Protects the drive firmware. When you enable the protection, you cannot update the drive firmware. 0 : Disabled 1 : Enabled</p>	0 (0, 1)	678
A1-12 (1564)	Bluetooth ID	<p>V/f CL-V/f OLV CLV AOLV OLV/PM AOLV/PM CLV/PM EZOLV</p> <p>Sets the password necessary to use Bluetooth to control the drive with a smartphone or tablet.</p>	- (0000 - 9999)	679

◆ A2: User Parameters

No. (Hex.)	Name	Description	Default (Range)	Ref.
A2-01 (0106)	User Parameter 1	<p>V/f CL-V/f OLV CLV AOLV OLV/PM AOLV/PM CLV/PM EZOLV</p> <p>Sets the parameter number to be shown for number 1 of the [User Custom Parameters] under the main menu. You can select a maximum of 32 parameters for the drive and set them to parameters A2-01 to A2-32.</p>	A1-02 (Determined by A1-06)	679
A2-02 (0107)	User Parameter 2	<p>V/f CL-V/f OLV CLV AOLV OLV/PM AOLV/PM CLV/PM EZOLV</p> <p>Sets the parameter number to be shown for number 2 of the [User Custom Parameters] under the main menu. You can select a maximum of 32 parameters for the drive and set them to parameters A2-01 to A2-32.</p>	b1-01 (Determined by A1-06)	679
A2-03 (0108)	User Parameter 3	<p>V/f CL-V/f OLV CLV AOLV OLV/PM AOLV/PM CLV/PM EZOLV</p> <p>Sets the parameter number to be shown for number 3 of the [User Custom Parameters] under the main menu. You can select a maximum of 32 parameters for the drive and set them to parameters A2-01 to A2-32.</p>	b1-02 (Determined by A1-06)	679
A2-04 (0109)	User Parameter 4	<p>V/f CL-V/f OLV CLV AOLV OLV/PM AOLV/PM CLV/PM EZOLV</p> <p>Sets the parameter number to be shown for number 4 of the [User Custom Parameters] under the main menu. You can select a maximum of 32 parameters for the drive and set them to parameters A2-01 to A2-32.</p>	b1-03 (Determined by A1-06)	679
A2-05 (010A)	User Parameter 5	<p>V/f CL-V/f OLV CLV AOLV OLV/PM AOLV/PM CLV/PM EZOLV</p> <p>Sets the parameter number to be shown for number 5 of the [User Custom Parameters] under the main menu. You can select a maximum of 32 parameters for the drive and set them to parameters A2-01 to A2-32.</p>	C1-01 (Determined by A1-06)	679
A2-06 (010B)	User Parameter 6	<p>V/f CL-V/f OLV CLV AOLV OLV/PM AOLV/PM CLV/PM EZOLV</p> <p>Sets the parameter number to be shown for number 6 of the [User Custom Parameters] under the main menu. You can select a maximum of 32 parameters for the drive and set them to parameters A2-01 to A2-32.</p>	C1-02 (Determined by A1-06)	679
A2-07 (010C)	User Parameter 7	<p>V/f CL-V/f OLV CLV AOLV OLV/PM AOLV/PM CLV/PM EZOLV</p> <p>Sets the parameter number to be shown for number 7 of the [User Custom Parameters] under the main menu. You can select a maximum of 32 parameters for the drive and set them to parameters A2-01 to A2-32.</p>	C6-01 (Determined by A1-06)	679
A2-08 (010D)	User Parameter 8	<p>V/f CL-V/f OLV CLV AOLV OLV/PM AOLV/PM CLV/PM EZOLV</p> <p>Sets the parameter number to be shown for number 8 of the [User Custom Parameters] under the main menu. You can select a maximum of 32 parameters for the drive and set them to parameters A2-01 to A2-32.</p>	C6-02 (Determined by A1-06)	679
A2-09 (010E)	User Parameter 9	<p>V/f CL-V/f OLV CLV AOLV OLV/PM AOLV/PM CLV/PM EZOLV</p> <p>Sets the parameter number to be shown for number 9 of the [User Custom Parameters] under the main menu. You can select a maximum of 32 parameters for the drive and set them to parameters A2-01 to A2-32.</p>	d1-01 (Determined by A1-06)	679
A2-10 (010F)	User Parameter 10	<p>V/f CL-V/f OLV CLV AOLV OLV/PM AOLV/PM CLV/PM EZOLV</p> <p>Sets the parameter number to be shown for number 10 of the [User Custom Parameters] under the main menu. You can select a maximum of 32 parameters for the drive and set them to parameters A2-01 to A2-32.</p>	d1-02 (Determined by A1-06)	679
A2-11 (0110)	User Parameter 11	<p>V/f CL-V/f OLV CLV AOLV OLV/PM AOLV/PM CLV/PM EZOLV</p> <p>Sets the parameter number to be shown for number 11 of the [User Custom Parameters] under the main menu. You can select a maximum of 32 parameters for the drive and set them to parameters A2-01 to A2-32.</p>	d1-03 (Determined by A1-06)	679
A2-12 (0111)	User Parameter 12	<p>V/f CL-V/f OLV CLV AOLV OLV/PM AOLV/PM CLV/PM EZOLV</p> <p>Sets the parameter number to be shown for number 12 of the [User Custom Parameters] under the main menu. You can select a maximum of 32 parameters for the drive and set them to parameters A2-01 to A2-32.</p>	d1-04 (Determined by A1-06)	679
A2-13 (0112)	User Parameter 13	<p>V/f CL-V/f OLV CLV AOLV OLV/PM AOLV/PM CLV/PM EZOLV</p> <p>Sets the parameter number to be shown for number 13 of the [User Custom Parameters] under the main menu. You can select a maximum of 32 parameters for the drive and set them to parameters A2-01 to A2-32.</p>	d1-17 (Determined by A1-06)	679

11.4 A: Initialization Parameters

No. (Hex.)	Name	Description	Default (Range)	Ref.
A2-30 (0123)	User Parameter 30	<p>V/f CL-V/f OLV CLV AOLV OLV/PM AOLV/PM CLV/PM EZOLV</p> <p>Sets the parameter number to be shown for number 30 of the [User Custom Parameters] under the main menu. You can select a maximum of 32 parameters for the drive and set them to parameters A2-01 to A2-32. You can set A2-17 to A2-32 when A2-33 = 0 [User Parameter Auto Selection = Disabled: Manual Entry Required].</p>	- (Determined by A1-06)	679
A2-31 (0124)	User Parameter 31	<p>V/f CL-V/f OLV CLV AOLV OLV/PM AOLV/PM CLV/PM EZOLV</p> <p>Sets the parameter number to be shown for number 31 of the [User Custom Parameters] under the main menu. You can select a maximum of 32 parameters for the drive and set them to parameters A2-01 to A2-32. You can set A2-17 to A2-32 when A2-33 = 0 [User Parameter Auto Selection = Disabled: Manual Entry Required].</p>	- (Determined by A1-06)	679
A2-32 (0125)	User Parameter 32	<p>V/f CL-V/f OLV CLV AOLV OLV/PM AOLV/PM CLV/PM EZOLV</p> <p>Sets the parameter number to be shown for number 32 of the [User Custom Parameters] under the main menu. You can select a maximum of 32 parameters for the drive and set them to parameters A2-01 to A2-32. You can set A2-17 to A2-32 when A2-33 = 0 [User Parameter Auto Selection = Disabled: Manual Entry Required].</p>	- (Determined by A1-06)	679
A2-33 (0126)	User Parameter Auto Selection	<p>V/f CL-V/f OLV CLV AOLV OLV/PM AOLV/PM CLV/PM EZOLV</p> <p>Sets the automatic save feature for changes to parameters A2-17 to A2-32 [User Parameters 17 to 32]. 0 : Disabled: Manual Entry Required 1 : Enabled: Auto Save Recent Parm</p>	Determined by A1-06 (0, 1)	679

11.5 b: Application

◆ b1: Operation Mode Selection

No. (Hex.)	Name	Description	Default (Setting Range)	Ref.
b1-01 (0180)	Frequency Reference Selection 1	<p>V/f CL-V/f OLV CLV AOLV OLV/PM AOLV/PM CLV/PM EZOLV</p> <p>Sets the input method for the frequency reference.</p> <p>0 : Keypad 1 : Analog Input 2 : Memobus/Modbus Communications 3 : Option PCB 4 : Pulse Train Input</p>	1 (0 - 4)	680
b1-02 (0181)	Run Command Selection 1	<p>V/f CL-V/f OLV CLV AOLV OLV/PM AOLV/PM CLV/PM EZOLV</p> <p>Sets the input method for the Run command.</p> <p>0 : Keypad 1 : Digital Input 2 : Memobus/Modbus Communications 3 : Option PCB</p>	1 (0 - 3)	682
b1-03 (0182)	Stopping Method Selection	<p>V/f CL-V/f OLV CLV AOLV OLV/PM AOLV/PM CLV/PM EZOLV</p> <p>Sets the method to stop the motor after removing a Run command or entering a Stop command.</p> <p>Note: When $A1-02 = 3, 4, 5, 6, 7, 8$ [Control Method Selection = CLV, AOLV, OLV/PM, AOLV/PM, CLV/PM, EZOLV], the setting range is 0, 1, 3.</p> <p>0 : Ramp to Stop 1 : Coast to Stop 2 : DC Injection Braking to Stop 3 : Coast to Stop with Timer 9 : Stop with Constant Distance</p>	0 (0 - 3, 9)	682
b1-04 (0183)	Reverse Operation Selection	<p>V/f CL-V/f OLV CLV AOLV OLV/PM AOLV/PM CLV/PM EZOLV</p> <p>Sets the reverse operation function. Disable reverse operation in fan or pump applications where reverse rotation is dangerous.</p> <p>0 : Reverse Enabled 1 : Reverse Disabled</p>	0 (0, 1)	686
b1-05 (0184)	Operation Below Minimum Freq	<p>V/f CL-V/f OLV CLV AOLV OLV/PM AOLV/PM CLV/PM EZOLV</p> <p>Sets the drive operation when the frequency reference decreases to less than the value set in $E1-09$ [Minimum Output Frequency].</p> <p>0 : Operate at Frequency Reference 1 : Baseblock (Motor Coasts) 2 : Operate at Minimum Frequency 3 : Operate at Zero Speed</p>	0 (0 - 3)	686
b1-06 (0185)	Digital Input Reading	<p>V/f CL-V/f OLV CLV AOLV OLV/PM AOLV/PM CLV/PM EZOLV</p> <p>Sets the number of times that the drive reads the sequence input command to prevent malfunction because of electrical interference.</p> <p>0 : Single Scan 1 : Double Scan</p>	1 (0, 1)	688
b1-07 (0186)	LOCAL/REMOTE Run Selection	<p>V/f CL-V/f OLV CLV AOLV OLV/PM AOLV/PM CLV/PM EZOLV</p> <p>Sets drive response to an existing Run command when the drive receives a second Run command from a different location.</p> <p>0 : Disregard Existing RUN Command 1 : Accept Existing RUN Command</p>	0 (0, 1)	688
b1-08 (0187)	Run Command Select in PRG Mode	<p>V/f CL-V/f OLV CLV AOLV OLV/PM AOLV/PM CLV/PM EZOLV</p> <p>Sets the conditions for the drive to accept a Run command entered from an external source when using the keypad to set parameters.</p> <p>0 : Disregard RUN while Programming 1 : Accept RUN while Programming 2 : Allow Programming Only at Stop</p>	0 (0 - 2)	688
b1-14 (01C3)	Phase Order Selection	<p>V/f CL-V/f OLV CLV AOLV OLV/PM AOLV/PM CLV/PM EZOLV</p> <p>Sets the phase order for output terminals U/T1, V/T2, and W/T3. This parameter can align the Forward Run command from the drive and the forward direction of the motor without changing wiring.</p> <p>0 : Standard 1 : Switch Phase Order</p>	0 (0, 1)	689

11.5 b: Application

No. (Hex.)	Name	Description	Default (Setting Range)	Ref.
b1-15 (01C4)	Frequency Reference Selection 2	<p>V/f CL-V/f OLV CLV AOLV OLV/PM AOLV/PM CLV/PM EZOLV</p> <p>Sets the input method for frequency reference 2.</p> <p>0 : Keypad 1 : Analog Input 2 : Memobus/Modbus Communications 3 : Option PCB 4 : Pulse Train Input</p>	0 (0 - 4)	689
b1-16 (01C5)	Run Command Selection 2	<p>V/f CL-V/f OLV CLV AOLV OLV/PM AOLV/PM CLV/PM EZOLV</p> <p>Sets the input method for Run Command 2 when the user switches the control circuit terminals ON/OFF to change the Run command source.</p> <p>0 : Keypad 1 : Digital Input 2 : Memobus/Modbus Communications 3 : Option PCB</p>	0 (0 - 3)	691
b1-17 (01C6)	Run Command at Power Up	<p>V/f CL-V/f OLV CLV AOLV OLV/PM AOLV/PM CLV/PM EZOLV</p> <p>Sets drive response when the CPU changes from de-energized to energized and there is an active Run command. Set this parameter in applications where energizing or de-energizing the drive enables the Run command. When the CPU stays energized during loss of power, L2-01 [Power Loss Ride Through Select] sets operation.</p> <p>0 : Disregard Existing RUN Command 1 : Accept Existing RUN Command</p>	0 (0, 1)	692
b1-21 (0748) Expert	CLV Start Selection	<p>V/f CL-V/f OLV CLV AOLV OLV/PM AOLV/PM CLV/PM EZOLV</p> <p>Sets the conditions for the drive to accept a Run command when A1-02 = 3, 7 [Control Method Selection = CLV, CLV/PM]. Usually it is not necessary to change this setting.</p> <p>0 : Reject RUN if b2-01 < U1-05 < E1-09 1 : Accept RUN Command at Any Speed</p>	0 (0, 1)	692
b1-35 (1117) Expert	Digital Input Deadband Time	<p>V/f CL-V/f OLV CLV AOLV OLV/PM AOLV/PM CLV/PM EZOLV</p> <p>Sets the deadband time for MFDIs.</p>	0.0 ms (0.0 to 100.0 ms)	692

◆ b2: DC Injection Braking and Short Circuit Braking

No. (Hex.)	Name	Description	Default (Range)	Ref.
b2-01 (0189)	DC Injection/Zero Speed Threshold	<p>V/f CL-V/f OLV CLV AOLV OLV/PM AOLV/PM CLV/PM EZOLV</p> <p>Sets the frequency to start DC Injection Braking, Short Circuit Braking, or Zero Servo near the end of a stop ramp.</p> <p>Note: This parameter is available when b1-03 = 0 [Stopping Method Selection = Ramp to Stop].</p>	Determined by A1-02 (0.0 - 10.0 Hz)	693
b2-02 (018A)	DC Injection Braking Current	<p>V/f CL-V/f OLV CLV AOLV OLV/PM AOLV/PM CLV/PM EZOLV</p> <p>Sets the DC Injection Braking current as a percentage of the drive rated current.</p>	50% (0 - 100%)	694
b2-03 (018B)	DC Inject Braking Time at Start	<p>V/f CL-V/f OLV CLV AOLV OLV/PM AOLV/PM CLV/PM EZOLV</p> <p>Sets the DC Injection Braking Time at stop. Sets the time of Zero Speed Control at start when A1-02 = 3, 7 [Control Method Selection = CLV, CLV/PM].</p>	A1-02 = 4: 0.30 s Other than A1-02 = 4: 0.00 s (0.00 - 10.00 s)	694
b2-04 (018C)	DC Inject Braking Time at Stop	<p>V/f CL-V/f OLV CLV AOLV OLV/PM AOLV/PM CLV/PM EZOLV</p> <p>Sets the DC Injection Braking Time at stop. Sets the time of Zero Speed Control at stop when A1-02 = 3, 7 [Control Method Selection = CLV, CLV/PM].</p>	Determined by A1-02 (0.00 - 10.00 s)	694
b2-08 (0190)	Magnetic Flux Compensation Value	<p>V/f CL-V/f OLV CLV AOLV OLV/PM AOLV/PM CLV/PM EZOLV</p> <p>Sets how much current the drive injects when DC Injection Braking at Start starts (Initial Excitation) as a percentage of E2-03 [Motor No-Load Current].</p>	0% (0 - 1000%)	695
b2-12 (01BA)	Short Circuit Brake Time @ Start	<p>V/f CL-V/f OLV CLV AOLV OLV/PM AOLV/PM CLV/PM EZOLV</p> <p>Sets the Short Circuit Braking time at start.</p>	0.00 s (0.00 - 25.50 s)	695
b2-13 (01BB)	Short Circuit Brake Time @ Stop	<p>V/f CL-V/f OLV CLV AOLV OLV/PM AOLV/PM CLV/PM EZOLV</p> <p>Sets the Short Circuit Braking time at stop.</p>	A1-02 = 8: 0.00 s Other than A1-02 = 8: 0.50 s (0.00 - 25.50 s)	695
b2-18 (0177)	Short Circuit Braking Current	<p>V/f CL-V/f OLV CLV AOLV OLV/PM AOLV/PM CLV/PM EZOLV</p> <p>Sets the Short Circuit Braking Current as a percentage of the motor rated current.</p> <p>Note: Parameter A1-02 [Control Method Selection] selects which parameter is the motor rated current. • A1-02 = 5, 6 [OLV/PM, AOLV/PM]: E5-03 [PM Motor Rated Current (FLA)] • A1-02 = 8 [EZOLV]: E9-06 [Motor Rated Current (FLA)]</p>	100.0% (0.0 - 200.0%)	696

◆ b3: Speed Search

No. (Hex.)	Name	Description	Default (Range)	Ref.
b3-01 (0191)	Speed Search at Start Selection	<p>V/f CL-V/f OLV CLV AOLV OLV/PM AOLV/PM CLV/PM EZOLV</p> <p>Sets the Speed Search at Start function so the drive will do Speed Search with each Run command.</p> <p>0 : Disable 1 : Enabled</p>	Determined by A1-02 (0, 1)	699
b3-02 (0192)	SpeedSearch Deactivation Current	<p>V/f CL-V/f OLV CLV AOLV OLV/PM AOLV/PM CLV/PM EZOLV</p> <p>Sets the current level that stops Speed Search as a percentage of the drive rated output current. Usually it is not necessary to change this setting.</p>	Determined by A1-02 (0 - 200%)	700
b3-03 (0193)	Speed Search Deceleration Time	<p>V/f CL-V/f OLV CLV AOLV OLV/PM AOLV/PM CLV/PM EZOLV</p> <p>Sets the deceleration time during Speed Search operation. Set the length of time to decelerate from the maximum output frequency to the minimum output frequency.</p> <p>Note: When $A1-02 = 8$ [Control Method Selection = EZOLV], this parameter takes effect only in Expert Mode.</p>	2.0 s (0.1 - 10.0 s)	700
b3-04 (0194)	V/f Gain during Speed Search	<p>V/f CL-V/f OLV CLV AOLV OLV/PM AOLV/PM CLV/PM EZOLV</p> <p>Sets the ratio used to reduce the V/f during searches to reduce the output current during speed searches.</p>	Determined by o2-04 (10 - 100)	700
b3-05 (0195)	Speed Search Delay Time	<p>V/f CL-V/f OLV CLV AOLV OLV/PM AOLV/PM CLV/PM EZOLV</p> <p>Sets the Speed Search delay time to activate a magnetic contactor installed between the drive and motor.</p>	0.2 s (0.0 - 100.0 s)	700
b3-06 (0196) Expert	Speed Estimation Current Level 1	<p>V/f CL-V/f OLV CLV AOLV OLV/PM AOLV/PM CLV/PM EZOLV</p> <p>Sets the level of current that flows to the motor during Speed Estimation Speed Search as a coefficient of the motor rated current. Usually it is not necessary to change this setting.</p>	Determined by o2-04 (0.0 - 2.0)	700
b3-07 (0197) Expert	Speed Estimation Current Level 2	<p>V/f CL-V/f OLV CLV AOLV OLV/PM AOLV/PM CLV/PM EZOLV</p> <p>Sets the level of current that flows to the motor during Speed Estimation Speed Search as a coefficient of $E2-03$ [Motor No-Load Current] or $E4-03$ [Motor 2 Rated No-Load Current]. Usually it is not necessary to change this setting.</p>	1.0 (0.0 - 3.0)	701
b3-08 (0198) Expert	Speed Estimation ACR P Gain	<p>V/f CL-V/f OLV CLV AOLV OLV/PM AOLV/PM CLV/PM EZOLV</p> <p>Sets the proportional gain for the automatic current regulator during Speed Estimation Speed Search. Also adjusts speed search responsiveness. Usually it is not necessary to change this setting.</p>	Determined by A1-02 and o2-04 (0.00 - 6.00)	701
b3-09 (0199) Expert	Speed Estimation ACR I Time	<p>V/f CL-V/f OLV CLV AOLV OLV/PM AOLV/PM CLV/PM EZOLV</p> <p>Sets the integral time for the automatic current regulator during Speed Estimation Speed Search. Also adjusts speed search responsiveness. Usually it is not necessary to change this setting.</p>	Determined by A1-02 (0.0 - 1000.0 ms)	701
b3-10 (019A) Expert	Speed Estimation Detection Gain	<p>V/f CL-V/f OLV CLV AOLV OLV/PM AOLV/PM CLV/PM EZOLV</p> <p>Sets the gain to correct estimated frequencies from Speed Estimation Speed Search.</p>	1.05 (1.00 - 1.20)	701
b3-14 (019E)	Bi-directional Speed Search	<p>V/f CL-V/f OLV CLV AOLV OLV/PM AOLV/PM CLV/PM EZOLV</p> <p>Sets the direction of Speed Search to the direction of the frequency reference or in the motor rotation direction as detected by the drive.</p> <p>0 : Disable 1 : Enabled</p> <p>Note:</p> <ul style="list-style-type: none"> The initial value of $b3-14$ is different for different $A1-02$ [Control Method Selection] settings when you set these parameters: <ul style="list-style-type: none"> $-A1-02 = 0, 2, 8$ [V/f, OLV, EZOLV] $-E9-01 = 0$ [Motor Type Selection = Induction (IM)] $-b3-24 = 1$ [Speed Search Method Selection = Speed Estimation]. The initial value of $b3-14$ is different for different $A1-02$ [Control Method Selection] settings when you set these parameters: <ul style="list-style-type: none"> $-A1-02 = 1, 4, 8$ [CL-V/f, AOLV, EZOLV] $-E9-01 = 1, 2$ [Permanent Magnet (PM), Synchronous Reluctance (SynRM)] The initial value of $b3-14$ is 0 when you set these parameters: <ul style="list-style-type: none"> $-A1-02 = 0, 2, 8$ $-E9-01 = 0$ $-b3-24 = 2$ [Current Detection 2] When you set $A1-02$, $b3-24$, and $E9-01$, set $b3-14$. 	Determined by A1-02, $b3-24$, and $E9-01$ (0, 1)	701
b3-17 (01F0) Expert	Speed Est Retry Current Level	<p>V/f CL-V/f OLV CLV AOLV OLV/PM AOLV/PM CLV/PM EZOLV</p> <p>Sets the current level for the search retry function in Speed Estimation Speed Search as a percentage where drive rated current is a setting value of 100%.</p>	150% (0 - 200%)	702
b3-18 (01F1) Expert	Speed Est Retry Detection Time	<p>V/f CL-V/f OLV CLV AOLV OLV/PM AOLV/PM CLV/PM EZOLV</p> <p>Sets the length of time that the drive will wait to retry Speed Estimation Speed Search when too much current flow stopped the Speed Search.</p>	0.10 s (0.00 - 1.00 s)	702
b3-19 (01F2)	Speed Search Restart Attempts	<p>V/f CL-V/f OLV CLV AOLV OLV/PM AOLV/PM CLV/PM EZOLV</p> <p>Sets the number of times to restart Speed Search if Speed Search does not complete.</p>	3 times (0 - 10 times)	702

11.5 b: Application

No. (Hex.)	Name	Description	Default (Range)	Ref.
b3-24 (01C0)	Speed Search Method Selection	<p><input type="checkbox"/> V/f <input type="checkbox"/> CL-V/f <input type="checkbox"/> OLV <input type="checkbox"/> CLV <input type="checkbox"/> AOLV <input type="checkbox"/> OLV/PM <input type="checkbox"/> AOLV/PM <input type="checkbox"/> CLV/PM <input type="checkbox"/> EZOLV</p> <p>Sets the Speed Search method when you start the motor or when you restore power after a momentary power loss.</p> <p>Note:</p> <ul style="list-style-type: none"> When $A1-02 = 8$ [Control Method Selection = EZOLV], the default setting changes when the setting for $E9-01$ [Motor Type Selection] and the drive model change. <ul style="list-style-type: none"> $E9-01 = 0$ [Induction (IM)] <ul style="list-style-type: none"> 2004 - 2313, 4002 - 4296: 1 2360, 2415, 4371 - 4H12: 2 $E9-01 = 1, 2$ [Permanent Magnet (PM), Synchronous Reluctance (SynRM)]: 1 When you set $A1-02 = 8$ and $E9-01 = 1$ or 2, also set $b3-24 = 1$. If $b3-24 = 2$, the drive will detect $oPE08$ [Parameter Selection Error]. When you set $b3-24$, it will trigger the drive to initialize $b3-14$ [Bi-directional Speed Search]. After you set $b3-24$, set $b3-14$. When $A1-02 = 4$ [AOLV], the default setting is 1 [Speed Estimation]. <p>1 : Speed Estimation 2 : Current Detection 2</p>	Determined by A1-02 (1, 2)	702
b3-25 (01C8) Expert	Speed Search Wait Time	<p><input type="checkbox"/> V/f <input type="checkbox"/> CL-V/f <input type="checkbox"/> OLV <input type="checkbox"/> CLV <input type="checkbox"/> AOLV <input type="checkbox"/> OLV/PM <input type="checkbox"/> AOLV/PM <input type="checkbox"/> CLV/PM <input type="checkbox"/> EZOLV</p> <p>Sets the length of time the drive will wait to start the Speed Search Retry function.</p>	0.5 s (0.0 - 30.0 s)	703
b3-26 (01C7) Expert	Direction Determination Level	<p><input type="checkbox"/> V/f <input type="checkbox"/> CL-V/f <input type="checkbox"/> OLV <input type="checkbox"/> CLV <input type="checkbox"/> AOLV <input type="checkbox"/> OLV/PM <input type="checkbox"/> AOLV/PM <input type="checkbox"/> CLV/PM <input type="checkbox"/> EZOLV</p> <p>Sets the level to find the motor rotation direction. Increase the value if the drive cannot find the direction.</p>	1000 (40 to 60000)	703
b3-27 (01C9) Expert	Speed Search RUN/BB Priority	<p><input type="checkbox"/> V/f <input type="checkbox"/> CL-V/f <input type="checkbox"/> OLV <input type="checkbox"/> CLV <input type="checkbox"/> AOLV <input type="checkbox"/> OLV/PM <input type="checkbox"/> AOLV/PM <input type="checkbox"/> CLV/PM <input type="checkbox"/> EZOLV</p> <p>Sets the conditions necessary to start Speed Search.</p> <p>0 : SS Only if RUN Applied Before BB 1 : SS Regardless of RUN/BB Sequence</p>	0 (0, 1)	703
b3-29 (077C) Expert	Speed Search Back-EMF Threshold	<p><input type="checkbox"/> V/f <input type="checkbox"/> CL-V/f <input type="checkbox"/> OLV <input type="checkbox"/> CLV <input type="checkbox"/> AOLV <input type="checkbox"/> OLV/PM <input type="checkbox"/> AOLV/PM <input type="checkbox"/> CLV/PM <input type="checkbox"/> EZOLV</p> <p>Sets the induced voltage for motors that use Speed Search. The drive will start Speed Search when the motor induced voltage level is the same as the setting value. Usually it is not necessary to change this setting.</p>	10% (0 - 10%)	703
b3-31 (0BC0) Expert	Spd Search Current Reference Lvl	<p><input type="checkbox"/> V/f <input type="checkbox"/> CL-V/f <input type="checkbox"/> OLV <input type="checkbox"/> CLV <input type="checkbox"/> AOLV <input type="checkbox"/> OLV/PM <input type="checkbox"/> AOLV/PM <input type="checkbox"/> CLV/PM <input type="checkbox"/> EZOLV</p> <p>Sets the current level that decreases the output current during Current Detection Speed Search.</p>	1.50 (1.50 - 3.50)	703
b3-32 (0BC1) Expert	Spd Search Current Complete Lvl	<p><input type="checkbox"/> V/f <input type="checkbox"/> CL-V/f <input type="checkbox"/> OLV <input type="checkbox"/> CLV <input type="checkbox"/> AOLV <input type="checkbox"/> OLV/PM <input type="checkbox"/> AOLV/PM <input type="checkbox"/> CLV/PM <input type="checkbox"/> EZOLV</p> <p>Sets the current level that completes Speed Search.</p>	1.20 (0.00 - 1.49)	703
b3-33 (0B3F) Expert	Speed Search during Uv Selection	<p><input type="checkbox"/> V/f <input type="checkbox"/> CL-V/f <input type="checkbox"/> OLV <input type="checkbox"/> CLV <input type="checkbox"/> AOLV <input type="checkbox"/> OLV/PM <input type="checkbox"/> AOLV/PM <input type="checkbox"/> CLV/PM <input type="checkbox"/> EZOLV</p> <p>Sets the function that starts Speed Search at start-up if the drive detects a Uv [Undervoltage] when it receives a Run command.</p> <p>0 : Disabled 1 : Enabled</p>	1 (0, 1)	704
b3-35 (0BC3) Expert	Low Back EMF Detection Level	<p><input type="checkbox"/> V/f <input type="checkbox"/> CL-V/f <input type="checkbox"/> OLV <input type="checkbox"/> CLV <input type="checkbox"/> AOLV <input type="checkbox"/> OLV/PM <input type="checkbox"/> AOLV/PM <input type="checkbox"/> CLV/PM <input type="checkbox"/> EZOLV</p> <p>Sets the Low Back EMF Detection Level. Usually it is not necessary to change this setting.</p>	10% (5 - 50%)	704
b3-36 (0BC4) Expert	High Back EMF Detection Level	<p><input type="checkbox"/> V/f <input type="checkbox"/> CL-V/f <input type="checkbox"/> OLV <input type="checkbox"/> CLV <input type="checkbox"/> AOLV <input type="checkbox"/> OLV/PM <input type="checkbox"/> AOLV/PM <input type="checkbox"/> CLV/PM <input type="checkbox"/> EZOLV</p> <p>Sets the voltage level for Speed Search restart. Usually it is not necessary to change this setting.</p>	0.970 (0.500 - 1.000)	704
b3-39 (1B8F) Expert	Regen Judgment Lv of Spd Search	<p><input type="checkbox"/> V/f <input type="checkbox"/> CL-V/f <input type="checkbox"/> OLV <input type="checkbox"/> CLV <input type="checkbox"/> AOLV <input type="checkbox"/> OLV/PM <input type="checkbox"/> AOLV/PM <input type="checkbox"/> CLV/PM <input type="checkbox"/> EZOLV</p> <p>Sets the level to determine the regenerative state during speed search. Usually it is not necessary to change this setting.</p>	15% (0 - 50%)	704
b3-54 (3123)	Search Time	<p><input type="checkbox"/> V/f <input type="checkbox"/> CL-V/f <input type="checkbox"/> OLV <input type="checkbox"/> CLV <input type="checkbox"/> AOLV <input type="checkbox"/> OLV/PM <input type="checkbox"/> AOLV/PM <input type="checkbox"/> CLV/PM <input type="checkbox"/> EZOLV</p> <p>Sets the length of time that the drive will run Speed Search.</p>	400 ms (10 - 2000 ms)	704
b3-55 (3124) Expert	Current Increment Time	<p><input type="checkbox"/> V/f <input type="checkbox"/> CL-V/f <input type="checkbox"/> OLV <input type="checkbox"/> CLV <input type="checkbox"/> AOLV <input type="checkbox"/> OLV/PM <input type="checkbox"/> AOLV/PM <input type="checkbox"/> CLV/PM <input type="checkbox"/> EZOLV</p> <p>Sets the length of time that the drive will increase the current from zero current to the setting value of $b3-06$ [Speed Estimation Current Level 1].</p>	10 ms (10 - 2000 ms)	705

No. (Hex.)	Name	Description	Default (Range)	Ref.
b3-56 (3126)	InverseRotationSearch WaitTime	V/f CL-V/f OLV CLV AOLV OLV/PM AOLV/PM CLV/PM EZOLV Sets the wait time until the drive starts inverse rotation search after it completes forward search when you do inverse rotation search during Current Detection Speed Search.	Determined by o2-04 (0.1 - 5.0 s)	705
b3-61 (1B96) Expert	Init Magnet Pole Estimation Gain	V/f CL-V/f OLV CLV AOLV OLV/PM AOLV/PM CLV/PM EZOLV Sets the responsiveness for initial motor magnetic pole calculation when $A1-02 = 6$ [Control Method Selection = AOLV/PM]. Set $b3-61 > 0.0$ for an ordinary IPM motor. When you use High Frequency Injection Auto-Tuning, the drive will automatically set this value. Note: • Set $n8-35 = 1$ [Initial Pole Calculation Method = High Frequency Injection] to enable this parameter. • When $A1-02 = 6$ [AOLV/PM] and you do High Frequency Injection Auto-Tuning, the drive automatically sets this parameter. • Set $n8-41$ [HFI P Gain] to adjust the responsiveness for initial motor magnetic pole calculation when $A1-02 = 5, 7$ [OLV/PM, CLV/PM].	5.0 (-20.0 - +20.0)	705

◆ b4: Timer Function

No. (Hex.)	Name	Description	Default (Range)	Ref.
b4-01 (01A3)	Timer Function ON-Delay Time	V/f CL-V/f OLV CLV AOLV OLV/PM AOLV/PM CLV/PM EZOLV Sets the ON-delay time for the timer input.	0.0 s (0.0 - 3000.0 s)	706
b4-02 (01A4)	Timer Function OFF-Delay Time	V/f CL-V/f OLV CLV AOLV OLV/PM AOLV/PM CLV/PM EZOLV Sets the OFF-delay time for the timer input.	0.0 s (0.0 - 3000.0 s)	706
b4-03 (0B30) Expert	Terminal M1-M2 ON-Delay Time	V/f CL-V/f OLV CLV AOLV OLV/PM AOLV/PM CLV/PM EZOLV Sets the delay time to activate the contact after the function set in $H2-01$ activates.	0 ms (0 - 65000 ms)	706
b4-04 (0B31) Expert	Terminal M1-M2 OFF-Delay Time	V/f CL-V/f OLV CLV AOLV OLV/PM AOLV/PM CLV/PM EZOLV Sets the delay time to deactivate the contact after the function set in $H2-01$ deactivates.	0 ms (0 - 65000 ms)	706
b4-05 (0B32) Expert	Terminal M3-M4 ON-Delay Time	V/f CL-V/f OLV CLV AOLV OLV/PM AOLV/PM CLV/PM EZOLV Sets the delay time to activate the contact after the function set in $H2-02$ activates.	0 ms (0 - 65000 ms)	706
b4-06 (0B33) Expert	Terminal M3-M4 OFF-Delay Time	V/f CL-V/f OLV CLV AOLV OLV/PM AOLV/PM CLV/PM EZOLV Sets the delay time to deactivate the contact after the function set in $H2-02$ deactivates.	0 ms (0 - 65000 ms)	707
b4-07 (0B34) Expert	Terminal M5-M6 ON-Delay Time	V/f CL-V/f OLV CLV AOLV OLV/PM AOLV/PM CLV/PM EZOLV Sets the delay time to activate the contact after the function set in $H2-03$ activates.	0 ms (0 - 65000 ms)	707
b4-08 (0B35) Expert	Terminal M5-M6 OFF-Delay Time	V/f CL-V/f OLV CLV AOLV OLV/PM AOLV/PM CLV/PM EZOLV Sets the delay time to deactivate the contact after the function set in $H2-03$ deactivates.	0 ms (0 - 65000 ms)	707

◆ b5: PID Control

No. (Hex.)	Name	Description	Default (Range)	Ref.
b5-01 (01A5)	PID Mode Setting	V/f CL-V/f OLV CLV AOLV OLV/PM AOLV/PM CLV/PM EZOLV Sets the type of PID control. 0 : Disabled 1 : Standard 2 : Standard (D on feedback) 3 : Fref + PID Trim 4 : Fref + PID Trim (D on feedback) 5 : Same as 7series & prior, b5-01=1 6 : Same as 7series & prior, b5-01=2 7 : Same as 7series & prior, b5-01=3 8 : Same as 7series & prior, b5-01=4 Note: Use settings 5 to 8 instead of settings 1 to 4 when the drive is a replacement for Varispeed F7.	0 (0 - 8)	712
b5-02 (01A6) RUN	Proportional Gain (P)	V/f CL-V/f OLV CLV AOLV OLV/PM AOLV/PM CLV/PM EZOLV Sets the proportional gain (P) that is applied to PID input.	1.00 (0.00 - 25.00)	713

11.5 b: Application

No. (Hex.)	Name	Description	Default (Range)	Ref.
b5-03 (01A7) RUN	Integral Time (I)	V/f CL-V/f OLV CLV AOLV OLV/PM AOLV/PM CLV/PM EZOLV Sets the integral time (I) that is applied to PID input.	1.0 s (0.0 - 360.0 s)	713
b5-04 (01A8) RUN	Integral Limit	V/f CL-V/f OLV CLV AOLV OLV/PM AOLV/PM CLV/PM EZOLV Sets the upper limit for integral control (I) as a percentage of the Maximum Output Frequency. Note: Parameter <i>A1-02 [Control Method Selection]</i> selects which parameter is the maximum output frequency. • <i>A1-02 ≠ 8 [EZOLV]: E1-04 [Maximum Output Frequency]</i> • <i>A1-02 = 8: E9-02 [Maximum Speed]</i>	100.0% (0.0 - 100.0%)	713
b5-05 (01A9) RUN	Derivative Time (D)	V/f CL-V/f OLV CLV AOLV OLV/PM AOLV/PM CLV/PM EZOLV Sets the derivative time (D) for PID control. This parameter adjusts system responsiveness.	0.00 s (0.00 - 10.00 s)	713
b5-06 (01AA) RUN	PID Output Limit	V/f CL-V/f OLV CLV AOLV OLV/PM AOLV/PM CLV/PM EZOLV Sets the maximum possible output from the PID controller as a percentage of the Maximum Output Frequency. Note: Parameter <i>A1-02 [Control Method Selection]</i> selects which parameter is the maximum output frequency. • <i>A1-02 ≠ 8 [EZOLV]: E1-04 [Maximum Output Frequency]</i> • <i>A1-02 = 8: E9-02 [Maximum Speed]</i>	100.0% (0.0 - 100.0%)	713
b5-07 (01AB) RUN	PID Offset Adjustment	V/f CL-V/f OLV CLV AOLV OLV/PM AOLV/PM CLV/PM EZOLV Sets the offset for the PID control output as a percentage of the Maximum Output Frequency. Note: Parameter <i>A1-02 [Control Method Selection]</i> selects which parameter is the maximum output frequency. • <i>A1-02 ≠ 8 [EZOLV]: E1-04 [Maximum Output Frequency]</i> • <i>A1-02 = 8: E9-02 [Maximum Speed]</i>	0.0% (-100.0% - +100.0%)	714
b5-08 (01AC) RUN Expert	PID Primary Delay Time Constant	V/f CL-V/f OLV CLV AOLV OLV/PM AOLV/PM CLV/PM EZOLV Sets the primary delay time constant for the PID control output. Usually it is not necessary to change this setting.	0.00 s (0.00 - 10.00 s)	714
b5-09 (01AD)	PID Output Level Selection	V/f CL-V/f OLV CLV AOLV OLV/PM AOLV/PM CLV/PM EZOLV Sets the polarity of the PID output. 0 : Normal Output (Direct Acting) 1 : Reverse Output (Reverse Acting)	0 (0, 1)	714
b5-10 (01AE) RUN	PID Output Gain Setting	V/f CL-V/f OLV CLV AOLV OLV/PM AOLV/PM CLV/PM EZOLV Sets the amount of gain to apply to the PID output.	1.00 (0.00 - 25.00)	714
b5-11 (01AF)	PID Output Reverse Selection	V/f CL-V/f OLV CLV AOLV OLV/PM AOLV/PM CLV/PM EZOLV Sets the function that enables and disables reverse motor rotation for negative PID control output. 0 : Lower Limit is Zero 1 : Negative Output Accepted	0 (0, 1)	714
b5-12 (01B0)	Feedback Loss Detection Select	V/f CL-V/f OLV CLV AOLV OLV/PM AOLV/PM CLV/PM EZOLV Sets the drive response to PID Feedback Low/High. Sets drive operation after the drive detects PID feedback Low/High. 0 : Digital Out Only, Always Detect 1 : Alarm + Digital Out, Always Det 2 : Fault + Digital Out, Always Det 3 : Digital Out Only, @ PID Enable 4 : Alarm + Digital Out, @PID Enable 5 : Fault + Digital Out, @PID Enable	0 (0 - 5)	715
b5-13 (01B1)	PID Feedback Loss Detection Lvl	V/f CL-V/f OLV CLV AOLV OLV/PM AOLV/PM CLV/PM EZOLV Sets the level that triggers <i>PID Feedback Loss [FbL]</i> detection as a percentage of the Maximum Output Frequency. Note: Parameter <i>A1-02 [Control Method Selection]</i> selects which parameter is the maximum output frequency. • <i>A1-02 ≠ 8 [EZOLV]: E1-04 [Maximum Output Frequency]</i> • <i>A1-02 = 8: E9-02 [Maximum Speed]</i>	0% (0 - 100%)	715
b5-14 (01B2)	PID Feedback Loss Detection Time	V/f CL-V/f OLV CLV AOLV OLV/PM AOLV/PM CLV/PM EZOLV Sets the length of time that PID Feedback must be less than <i>b5-13 [PID Feedback Loss Detection Lvl]</i> to detect <i>PID Feedback Loss [FbL]</i> .	1.0 s (0.0 - 25.5 s)	716
b5-15 (01B3)	PID Sleep Function Start Level	V/f CL-V/f OLV CLV AOLV OLV/PM AOLV/PM CLV/PM EZOLV Sets the output level that triggers the PID Sleep function.	Determined by A1-02 (0.0 - 590.0)	716

No. (Hex.)	Name	Description	Default (Range)	Ref.
b5-16 (01B4)	PID Sleep Delay Time	V/f CL-V/f OLV CLV AOLV OLV/PM AOLV/PM CLV/PM EZOLV Sets a delay time to start or stop the PID Sleep function.	0.0 s (0.0 - 25.5 s)	716
b5-17 (01B5) RUN	PID Accel/Decel Time	V/f CL-V/f OLV CLV AOLV OLV/PM AOLV/PM CLV/PM EZOLV Raises or lowers the PID setpoint using the acceleration and deceleration times set to the drive. This is a soft-starter for the PID setpoint.	0.0 s (0.0 - 6000.0 s)	716
b5-18 (01DC)	b5-19 PID Setpoint Selection	V/f CL-V/f OLV CLV AOLV OLV/PM AOLV/PM CLV/PM EZOLV Sets the function that enables and disables <i>b5-19 [PID Setpoint Value]</i> . 0 : Disabled 1 : Enabled	0 (0, 1)	716
b5-19 (01DD) RUN	PID Setpoint Value	V/f CL-V/f OLV CLV AOLV OLV/PM AOLV/PM CLV/PM EZOLV Sets the PID setpoint when <i>b5-18 = 1 [b5-19 PID Setpoint Selection = Enabled]</i> .	0.00% (0.00 - 100.00%)	716
b5-20 (01E2)	PID Unit Selection	V/f CL-V/f OLV CLV AOLV OLV/PM AOLV/PM CLV/PM EZOLV Sets the number of digits to set and show the PID setpoint. 0 : 0.01Hz units 1 : 0.01% units 2 : min ⁻¹ 3 : User Units	1 (0 - 3)	717
b5-34 (019F) RUN	PID Output Lower Limit Level	V/f CL-V/f OLV CLV AOLV OLV/PM AOLV/PM CLV/PM EZOLV Sets the lower limit level for the PID control as a percentage of <i>E1-04 [Maximum Output Frequency]</i> . When you use <i>b5-34</i> , set <i>b5-91 = 0 [EZ Sleep Minimum Speed = 0 (Disabled)]</i> . When you set the output lower limit level as Hz units or min ⁻¹ (r/min) units, refer to page 721. Note: Parameter <i>A1-02 [Control Method Selection]</i> selects which parameter is the maximum output frequency. • <i>A1-02 ≠ 8 [EZOLV]: E1-04 [Maximum Output Frequency]</i> • <i>A1-02 = 8: E9-02 [Maximum Speed]</i>	0.0% (-100.0 - +100.0%)	717
b5-35 (01A0) RUN	PID Input Limit Level	V/f CL-V/f OLV CLV AOLV OLV/PM AOLV/PM CLV/PM EZOLV Sets the output upper limit for the PID control as a percentage of the Maximum Output Frequency. Note: Parameter <i>A1-02 [Control Method Selection]</i> selects which parameter is the maximum output frequency. • <i>A1-02 ≠ 8 [EZOLV]: E1-04 [Maximum Output Frequency]</i> • <i>A1-02 = 8: E9-02 [Maximum Speed]</i>	1000.0% (0.0 - 1000.0%)	717
b5-36 (01A1)	PID High Feedback Detection Lvl	V/f CL-V/f OLV CLV AOLV OLV/PM AOLV/PM CLV/PM EZOLV Sets the level that triggers <i>Excessive PID Feedback [FbH]</i> as a percentage of the Maximum Output Frequency. Note: Parameter <i>A1-02 [Control Method Selection]</i> selects which parameter is the maximum output frequency. • <i>A1-02 ≠ 8 [EZOLV]: E1-04 [Maximum Output Frequency]</i> • <i>A1-02 = 8: E9-02 [Maximum Speed]</i>	100% (0 - 100%)	717
b5-37 (01A2)	PID High Feedback Detection Time	V/f CL-V/f OLV CLV AOLV OLV/PM AOLV/PM CLV/PM EZOLV Sets the length of time that the PID feedback signal must be more than the level set in <i>b5-36 [PID Feedback High Detection Lvl]</i> to cause <i>Excessive PID Feedback [FbH]</i> .	1.0 s (0.0 - 25.5 s)	718
b5-38 (01FE)	PID User Unit Display Scaling	V/f CL-V/f OLV CLV AOLV OLV/PM AOLV/PM CLV/PM EZOLV Sets the value that the drive sets or shows as the PID setpoint when at the maximum output frequency.	Determined by b5-20 (1 - 60000)	718
b5-39 (01FF)	PID User Unit Display Digits	V/f CL-V/f OLV CLV AOLV OLV/PM AOLV/PM CLV/PM EZOLV Sets the number of digits to set and show the PID setpoint. 0 : No Decimal Places (XXXXX) 1 : One Decimal Places (XXXX.X) 2 : Two Decimal Places (XXX.XX) 3 : Three Decimal Places (XX.XXX)	Determined by b5-20 (0 - 3)	718
b5-40 (017F)	Frequency Reference Monitor @PID	V/f CL-V/f OLV CLV AOLV OLV/PM AOLV/PM CLV/PM EZOLV Sets the contents for monitor <i>U1-01 [Frequency Reference]</i> in PID control. 0 : U1-01 Includes PID Output 1 : U1-01 Excludes PID Output	0 (0, 1)	718
b5-47 (017D)	PID Trim Mode Output Reverse Sel	V/f CL-V/f OLV CLV AOLV OLV/PM AOLV/PM CLV/PM EZOLV Sets reverse motor rotation when the PID control output is negative. 0 : Lower Limit is Zero 1 : Negative Output Accepted	1 (0, 1)	719
b5-53 (0B8F) RUN	PID Integrator Ramp Limit	V/f CL-V/f OLV CLV AOLV OLV/PM AOLV/PM CLV/PM EZOLV Sets the responsiveness of PID control when the PID feedback changes quickly.	0.0 Hz (0.0 - 10.0 Hz)	719

11.5 b: Application

No. (Hex.)	Name	Description	Default (Range)	Ref.
b5-55 (0BE1)	PID Feedback Monitor Selection	<p>V/f CL-V/f OLV CLV AOLV OLV/PM AOLV/PM CLV/PM EZOLV</p> <p>Sets the monitor (<i>Ux-xx</i>) used as the PID Feedback.</p> <p>Note: Set the <i>x-xx</i> part of the <i>Ux-xx</i> [Monitor]. For example, set <i>b5-55 = 102</i> to monitor <i>U1-02</i> [Output Frequency]. When the <i>x</i> part of <i>Ux</i> is a letter, replace the letter (hexadecimal number) with a decimal number. For example, set <i>b5-55 = 1301</i> to monitor <i>Ud-01</i>.</p>	000 (000 - 9999)	719
b5-56 (0BE2)	PID Feedback Monitor Gain	<p>V/f CL-V/f OLV CLV AOLV OLV/PM AOLV/PM CLV/PM EZOLV</p> <p>Sets the gain for the monitor set in <i>b5-55</i> [PID Feedback Monitor Selection].</p>	1.00 (0.00 - 10.00)	719
b5-57 (11DD)	PID Feedback Monitor Bias	<p>V/f CL-V/f OLV CLV AOLV OLV/PM AOLV/PM CLV/PM EZOLV</p> <p>Sets the bias for the monitor specified in <i>b5-55</i> [PID Feedback Monitor Selection].</p>	0.00 (-10.00 - +10.00)	719
b5-58 (1182) RUN	PID Setpoints 2	<p>V/f CL-V/f OLV CLV AOLV OLV/PM AOLV/PM CLV/PM EZOLV</p> <p>Sets the PID setpoint when <i>H1-xx = 3E</i> or <i>3F</i> [MFDI Function Select = PID Setpoint Selection 1/2]. This value is a percentage of the maximum output frequency.</p> <p>Note: Parameter <i>A1-02</i> [Control Method Selection] selects which parameter is the maximum output frequency. • <i>A1-02 ≠ 8</i> [EZOLV]: <i>E1-04</i> [Maximum Output Frequency] • <i>A1-02 = 8</i>: <i>E9-02</i> [Maximum Speed]</p>	0.00% (0.00 - 100.00%)	719
b5-59 (1183) RUN	PID Setpoints 3	<p>V/f CL-V/f OLV CLV AOLV OLV/PM AOLV/PM CLV/PM EZOLV</p> <p>Sets the PID setpoint when <i>H1-xx = 3E</i> or <i>3F</i> [MFDI Function Select = PID Setpoint Selection 1/2]. This value is a percentage of the maximum output frequency.</p> <p>Note: Parameter <i>A1-02</i> [Control Method Selection] selects which parameter is the maximum output frequency. • <i>A1-02 ≠ 8</i> [EZOLV]: <i>E1-04</i> [Maximum Output Frequency] • <i>A1-02 = 8</i>: <i>E9-02</i> [Maximum Speed]</p>	0.00% (0.00 - 100.00%)	719
b5-60 (1184) RUN	PID Setpoints 4	<p>V/f CL-V/f OLV CLV AOLV OLV/PM AOLV/PM CLV/PM EZOLV</p> <p>Sets the PID setpoint when <i>H1-xx = 3E</i> or <i>3F</i> [MFDI Function Select = PID Setpoint Selection 1/2]. This value is a percentage of the maximum output frequency.</p> <p>Note: Parameter <i>A1-02</i> [Control Method Selection] selects which parameter is the maximum output frequency. • <i>A1-02 ≠ 8</i> [EZOLV]: <i>E1-04</i> [Maximum Output Frequency] • <i>A1-02 = 8</i>: <i>E9-02</i> [Maximum Speed]</p>	0.00% (0.00 - 100.00%)	719
b5-61 (119A)	PID Trim Mode Lower Limit Sel	<p>V/f CL-V/f OLV CLV AOLV OLV/PM AOLV/PM CLV/PM EZOLV</p> <p>Sets the function that adjusts the PID output in relation to the frequency reference.</p> <p>0 : Disabled 1 : Enabled</p>	0 (0, 1)	720
b5-62 (119B)	PID Trim Mode Lower Limit Value	<p>V/f CL-V/f OLV CLV AOLV OLV/PM AOLV/PM CLV/PM EZOLV</p> <p>Sets the PID Trim Mode Lower Limit Value as a percentage of the maximum output frequency.</p> <p>Note: Parameter <i>A1-02</i> [Control Method Selection] selects which parameter is the maximum output frequency. • <i>A1-02 ≠ 8</i> [EZOLV]: <i>E1-04</i> [Maximum Output Frequency] • <i>A1-02 = 8</i>: <i>E9-02</i> [Maximum Speed]</p>	0.00% (0.00 - 100.00%)	720
b5-63 (119C)	PID Differential FB Monitor Sel	<p>V/f CL-V/f OLV CLV AOLV OLV/PM AOLV/PM CLV/PM EZOLV</p> <p>Selects the monitor (<i>Ux-xx</i>) used as the PID Differential Feedback.</p> <p>Note: Set the <i>x-xx</i> part of the <i>Ux-xx</i> [Monitor]. For example, set <i>b5-63 = 103</i> to monitor <i>U1-03</i> [Output Current]. When the <i>x</i> part of <i>Ux</i> is a letter, replace the letter (hexadecimal number) with a decimal number. For example, set <i>b5-63 = 1301</i> to monitor <i>Ud-01</i>.</p>	000 (000 - 9999)	720
b5-64 (119D)	PID Differential FB Monitor Gain	<p>V/f CL-V/f OLV CLV AOLV OLV/PM AOLV/PM CLV/PM EZOLV</p> <p>Sets the gain for the monitor specified in <i>b5-63</i> [PID Differential FB Monitor Sel].</p>	1.00 (0.00 - 10.00)	720
b5-65 (119F)	PID Differential FB Monitor Bias	<p>V/f CL-V/f OLV CLV AOLV OLV/PM AOLV/PM CLV/PM EZOLV</p> <p>Sets the bias for the monitor specified in <i>b5-63</i> [PID Differential FB Monitor Sel].</p>	0.00 (-10.00 - +10.00)	721
b5-66 (11DE)	PID Feedback Monitor Level	<p>V/f CL-V/f OLV CLV AOLV OLV/PM AOLV/PM CLV/PM EZOLV</p> <p>Sets the signal level for the monitor specified in <i>b5-55</i> [PID Feedback Monitor Selection].</p> <p>0 : Absolute 1 : Bi-directional (+/-)</p>	0 (0, 1)	721
b5-67 (11DF)	PID Differential FB Monitor Lvl	<p>V/f CL-V/f OLV CLV AOLV OLV/PM AOLV/PM CLV/PM EZOLV</p> <p>Sets the signal level for the monitor specified in <i>b5-63</i> [PID Differential FB Monitor Sel].</p> <p>0 : Absolute 1 : Bi-directional (+/-)</p>	0 (0, 1)	721

No. (Hex.)	Name	Description	Default (Range)	Ref.
b5-89 (0B89) RUN	Sleep Method Selection	V/f CL-V/f OLV CLV AOLV OLV/PM AOLV/PM CLV/PM EZOLV Sets sleep and wake up operation when using PID. 0 : Standard 1 : EZ Sleep/Wake-up	0 (0, 1)	721
b5-90 (0B90)	EZ Sleep Unit	V/f CL-V/f OLV CLV AOLV OLV/PM AOLV/PM CLV/PM EZOLV Sets the measurement units for b5-91 [EZ Sleep Minimum Speed] and b5-92 [EZ Sleep Level]. 0 : 0.1Hz units 1 : rev/min	0 (0, 1)	721
b5-91 (0B91) RUN	EZ Sleep Minimum Speed	V/f CL-V/f OLV CLV AOLV OLV/PM AOLV/PM CLV/PM EZOLV Sets the output lower limit level for the PID control as Hz units or min ⁻¹ (r/min) units. When you use b5-91, set b5-34 = 0.0 [PID Output Lower Limit Level = 0.0 (disabled)]. When you set the output lower limit for PID output as a percentage of the Maximum Output Frequency, refer to page 717.	0.0 Hz or 0 min ⁻¹ (r/min) (0.0 to 590.0 Hz or 0 to 35400 min ⁻¹ (r/min))	721
b5-92 (0B92) RUN	EZ Sleep Level	V/f CL-V/f OLV CLV AOLV OLV/PM AOLV/PM CLV/PM EZOLV Sets the value that the output frequency or motor speed must be less than for longer than b5-93 [EZ Sleep Time] to enter Sleep Mode.	0.0 Hz or 0 min ⁻¹ (r/min) (0.0 to 590.0 Hz or 0 to 35400 min ⁻¹ (r/min))	722
b5-93 (0B93) RUN	EZ Sleep Time	V/f CL-V/f OLV CLV AOLV OLV/PM AOLV/PM CLV/PM EZOLV Sets the length of time that the output frequency or motor speed must be less than b5-92 [EZ Sleep Level] to enter Sleep Mode.	5.0 s (0.0 - 1000.0 s)	722
b5-94 (0B94) RUN	EZ Sleep Wake-up Level	V/f CL-V/f OLV CLV AOLV OLV/PM AOLV/PM CLV/PM EZOLV Sets the level at which the drive resumes operation when exiting Sleep Mode.	0.00% (0.00 - 600.00%)	722
b5-95 (0B95)	EZ Sleep Wake-up Mode	V/f CL-V/f OLV CLV AOLV OLV/PM AOLV/PM CLV/PM EZOLV Sets the wake-up mode to use when exiting Sleep Mode. 0 : Absolute 1 : Setpoint Delta	0 (0, 1)	722
b5-96 (0B96) RUN	EZ Sleep Wake-up Time	V/f CL-V/f OLV CLV AOLV OLV/PM AOLV/PM CLV/PM EZOLV Sets the EZ Wake-up time.	1.0 s (0.0 - 1000.0 s)	722

◆ b6: Dwell Function

No. (Hex.)	Name	Description	Default (Range)	Ref.
b6-01 (01B6)	Dwell Reference at Start	V/f CL-V/f OLV CLV AOLV OLV/PM AOLV/PM CLV/PM EZOLV Sets the output frequency that the drive will hold momentarily when the motor starts.	0.0 (Determined by A1-02)	723
b6-02 (01B7)	Dwell Time at Start	V/f CL-V/f OLV CLV AOLV OLV/PM AOLV/PM CLV/PM EZOLV Sets the length of time that the drive will hold the output frequency when the motor starts.	0.0 s (0.0 - 10.0 s)	723
b6-03 (01B8)	Dwell Reference at Stop	V/f CL-V/f OLV CLV AOLV OLV/PM AOLV/PM CLV/PM EZOLV Sets the output frequency that the drive will hold momentarily when ramping to stop the motor.	0.0 (Determined by A1-02)	723
b6-04 (01B9)	Dwell Time at Stop	V/f CL-V/f OLV CLV AOLV OLV/PM AOLV/PM CLV/PM EZOLV Sets the length of time for the drive to hold the output frequency when ramping to stop the motor.	0.0 s (0.0 - 10.0 s)	723

◆ b7: Droop Control

No. (Hex.)	Name	Description	Default (Range)	Ref.
b7-01 (01CA) RUN	Droop Control Gain	V/f CL-V/f OLV CLV AOLV OLV/PM AOLV/PM CLV/PM EZOLV Sets the amount of deceleration when the torque reference is at 100% as a percentage of E1-04 [Maximum Output Frequency].	0.0% (0.0 - 100.0%)	724
b7-02 (01CB) RUN	Droop Control Delay Time	V/f CL-V/f OLV CLV AOLV OLV/PM AOLV/PM CLV/PM EZOLV Sets the responsiveness of Droop control. Decrease this setting when drive response is slow. Increase this setting when hunting or oscillation occur.	0.05 s (0.03 - 2.00 s)	724
b7-03 (017E)	Droop Control Limit Selection	V/f CL-V/f OLV CLV AOLV OLV/PM AOLV/PM CLV/PM EZOLV Sets the Droop control limit function. 0 : Disabled 1 : Enabled	1 (0, 1)	724

◆ b8: Energy Saving

No. (Hex.)	Name	Description	Default (Range)	Ref.
b8-01 (01CC)	Energy Saving Control Selection	<p><input type="checkbox"/> V/f <input type="checkbox"/> CL-V/f <input checked="" type="checkbox"/> OLV <input type="checkbox"/> CLV <input type="checkbox"/> AOLV <input type="checkbox"/> OLV/PM <input type="checkbox"/> AOLV/PM <input type="checkbox"/> CLV/PM <input type="checkbox"/> EZOLV</p> <p>Sets the Energy-saving control function. 0 : Disabled 1 : Enabled 2 : Automatic Optimization</p> <p>Note: Setting 2 is available only when A1-02 = 6, 7 [Control Method Selection = AOLV/PM, CLV/PM] and in Expert Mode.</p>	0 (0 - 2)	725
b8-02 (01CD) RUN Expert	Energy Saving Gain	<p><input type="checkbox"/> V/f <input type="checkbox"/> CL-V/f <input checked="" type="checkbox"/> OLV <input type="checkbox"/> CLV <input type="checkbox"/> AOLV <input type="checkbox"/> OLV/PM <input type="checkbox"/> AOLV/PM <input type="checkbox"/> CLV/PM <input type="checkbox"/> EZOLV</p> <p>Sets the gain for Energy-saving control.</p>	Determined by A1-02 (0.0 - 10.0)	725
b8-03 (01CE) RUN Expert	Energy Saving Filter Time	<p><input type="checkbox"/> V/f <input type="checkbox"/> CL-V/f <input checked="" type="checkbox"/> OLV <input type="checkbox"/> CLV <input type="checkbox"/> AOLV <input type="checkbox"/> OLV/PM <input type="checkbox"/> AOLV/PM <input type="checkbox"/> CLV/PM <input type="checkbox"/> EZOLV</p> <p>Sets the responsiveness for Energy-saving control.</p>	Determined by A1-02 , C6-01 and o2-04 (0.00 - 10.00 s)	725
b8-04 (01CF) Expert	Energy Saving Coefficient Value	<p><input type="checkbox"/> V/f <input type="checkbox"/> CL-V/f <input type="checkbox"/> OLV <input type="checkbox"/> CLV <input type="checkbox"/> AOLV <input type="checkbox"/> OLV/PM <input type="checkbox"/> AOLV/PM <input type="checkbox"/> CLV/PM <input type="checkbox"/> EZOLV</p> <p>Sets the Energy-saving control coefficient to maintain maximum motor efficiency. The default setting is for Yaskawa motors.</p>	Determined by C6-01, E2-11, and o2-04 (0.00 - 655.00)	725
b8-05 (01D0) Expert	Power Detection Filter Time	<p><input type="checkbox"/> V/f <input type="checkbox"/> CL-V/f <input type="checkbox"/> OLV <input type="checkbox"/> CLV <input type="checkbox"/> AOLV <input type="checkbox"/> OLV/PM <input type="checkbox"/> AOLV/PM <input type="checkbox"/> CLV/PM <input type="checkbox"/> EZOLV</p> <p>Sets the time constant to measure output power.</p>	20 ms (0 - 2000 ms)	726
b8-06 (01D1) Expert	Search Operation Voltage Limit	<p><input type="checkbox"/> V/f <input type="checkbox"/> CL-V/f <input type="checkbox"/> OLV <input type="checkbox"/> CLV <input type="checkbox"/> AOLV <input type="checkbox"/> OLV/PM <input type="checkbox"/> AOLV/PM <input type="checkbox"/> CLV/PM <input type="checkbox"/> EZOLV</p> <p>Sets the voltage limit for Search Operation as a percentage of the motor rated voltage.</p>	0% (0 - 100%)	726
b8-16 (01F8) Expert	PM E-Save Coefficient Ki	<p><input type="checkbox"/> V/f <input type="checkbox"/> CL-V/f <input type="checkbox"/> OLV <input type="checkbox"/> CLV <input type="checkbox"/> AOLV <input type="checkbox"/> OLV/PM <input type="checkbox"/> AOLV/PM <input type="checkbox"/> CLV/PM <input type="checkbox"/> EZOLV</p> <p>Sets torque linearity. This parameter uses the Ki value from the motor nameplate. Usually it is not necessary to change this setting.</p>	1.00 (0.00 - 3.00)	726
b8-17 (01F9) Expert	PM E-Save Coefficient Kt	<p><input type="checkbox"/> V/f <input type="checkbox"/> CL-V/f <input type="checkbox"/> OLV <input type="checkbox"/> CLV <input type="checkbox"/> AOLV <input type="checkbox"/> OLV/PM <input type="checkbox"/> AOLV/PM <input type="checkbox"/> CLV/PM <input type="checkbox"/> EZOLV</p> <p>Sets torque linearity. This parameter uses the Kt value from the motor nameplate. Usually it is not necessary to change this setting.</p>	1.00 (0.00 - 3.00)	726
b8-18 (01FA) Expert	E-Save d-axis Current FilterTime	<p><input type="checkbox"/> V/f <input type="checkbox"/> CL-V/f <input type="checkbox"/> OLV <input type="checkbox"/> CLV <input type="checkbox"/> AOLV <input type="checkbox"/> OLV/PM <input type="checkbox"/> AOLV/PM <input type="checkbox"/> CLV/PM <input type="checkbox"/> EZOLV</p> <p>Sets the d-axis current reference filter time constant.</p>	0.100 s (0.000 - 5.000 s)	726
b8-19 (0B40) Expert	E-Save Search Frequency	<p><input type="checkbox"/> V/f <input type="checkbox"/> CL-V/f <input type="checkbox"/> OLV <input type="checkbox"/> CLV <input type="checkbox"/> AOLV <input type="checkbox"/> OLV/PM <input type="checkbox"/> AOLV/PM <input type="checkbox"/> CLV/PM <input type="checkbox"/> EZOLV</p> <p>Sets the frequency of Energy-saving control search operations. Usually it is not necessary to change this setting.</p>	Determined by A1-02 (10 - 300 Hz)	727
b8-20 (0B41) Expert	E-Save Search Width	<p><input type="checkbox"/> V/f <input type="checkbox"/> CL-V/f <input type="checkbox"/> OLV <input type="checkbox"/> CLV <input type="checkbox"/> AOLV <input type="checkbox"/> OLV/PM <input type="checkbox"/> AOLV/PM <input type="checkbox"/> CLV/PM <input type="checkbox"/> EZOLV</p> <p>Sets the amplitude of Energy-saving control search operations.</p>	1.0 degrees (0.1 - 5.0 degrees)	727
b8-21 (0B42) Expert	PM E-Save Search Gain	<p><input type="checkbox"/> V/f <input type="checkbox"/> CL-V/f <input type="checkbox"/> OLV <input type="checkbox"/> CLV <input type="checkbox"/> AOLV <input type="checkbox"/> OLV/PM <input type="checkbox"/> AOLV/PM <input type="checkbox"/> CLV/PM <input type="checkbox"/> EZOLV</p> <p>Sets the gain of Energy-saving control search operations.</p>	0.3Hz (0.1 - 20.0 Hz)	727
b8-22 (0B43) Expert	PM E-Save Search LPF Cutoff Freq	<p><input type="checkbox"/> V/f <input type="checkbox"/> CL-V/f <input type="checkbox"/> OLV <input type="checkbox"/> CLV <input type="checkbox"/> AOLV <input type="checkbox"/> OLV/PM <input type="checkbox"/> AOLV/PM <input type="checkbox"/> CLV/PM <input type="checkbox"/> EZOLV</p> <p>Sets the frequency of the filter used to extract the high-efficiency phase from search operations. Usually it is not necessary to change this setting.</p>	10.0 Hz (1.0 - 30.0 Hz)	727
b8-23 (0B44) Expert	PM E-Save Search Limit	<p><input type="checkbox"/> V/f <input type="checkbox"/> CL-V/f <input type="checkbox"/> OLV <input type="checkbox"/> CLV <input type="checkbox"/> AOLV <input type="checkbox"/> OLV/PM <input type="checkbox"/> AOLV/PM <input type="checkbox"/> CLV/PM <input type="checkbox"/> EZOLV</p> <p>Sets the search operations output limit. Usually it is not necessary to change this setting.</p>	15.0 degrees (0.0 - 30.0 degrees)	727
b8-24 (0B45) Expert	PM E-Save High Freq ACR Gain	<p><input type="checkbox"/> V/f <input type="checkbox"/> CL-V/f <input type="checkbox"/> OLV <input type="checkbox"/> CLV <input type="checkbox"/> AOLV <input type="checkbox"/> OLV/PM <input type="checkbox"/> AOLV/PM <input type="checkbox"/> CLV/PM <input type="checkbox"/> EZOLV</p> <p>Sets the gain for high-frequency current control.</p>	200.0 Hz (100.0 - 1000.0 Hz)	727
b8-25 (0B46) Expert	PM E-Save Search Start Level	<p><input type="checkbox"/> V/f <input type="checkbox"/> CL-V/f <input type="checkbox"/> OLV <input type="checkbox"/> CLV <input type="checkbox"/> AOLV <input type="checkbox"/> OLV/PM <input type="checkbox"/> AOLV/PM <input type="checkbox"/> CLV/PM <input type="checkbox"/> EZOLV</p> <p>Sets the start level for search operations.</p>	10.0% (0.0 - 100.0%)	728
b8-26 (0B47) Expert	PM E-Save Power Setpoint	<p><input type="checkbox"/> V/f <input type="checkbox"/> CL-V/f <input type="checkbox"/> OLV <input type="checkbox"/> CLV <input type="checkbox"/> AOLV <input type="checkbox"/> OLV/PM <input type="checkbox"/> AOLV/PM <input type="checkbox"/> CLV/PM <input type="checkbox"/> EZOLV</p> <p>Sets a value to increase torque accuracy.</p>	0.0% (-10.0 - +10.0%)	728

No. (Hex.)	Name	Description	Default (Range)	Ref.
b8-28 (0B8B) Expert	Over Excitation Action Selection	<div style="display: flex; justify-content: space-between; gap: 5px;"> V/f CL-V/f OLV CLV AOLV OLV/PM AOLV/PM CLV/PM EZOLV </div> <p>Sets the function for excitation operation. 0 : Disabled 1 : Enabled</p>	0 (0, 1)	728
b8-29 (0B8C)	Energy Saving Priority Selection	<div style="display: flex; justify-content: space-between; gap: 5px;"> V/f CL-V/f OLV CLV AOLV OLV/PM AOLV/PM CLV/PM EZOLV </div> <p>Sets the priority of drive response between changes to the load or Energy-saving control. Enable this to prioritize energy-saving control. Disable this to prioritize tracking related to fast load changes, and prevent motor stall. 0 : Priority: Drive Response 1 : Priority: Energy Savings</p>	0 (0, 1)	728
b8-50 (0B0D)	Standby Mode Selection	<div style="display: flex; justify-content: space-between; gap: 5px;"> V/f CL-V/f OLV CLV AOLV OLV/PM AOLV/PM CLV/PM EZOLV </div> <p>Sets the Standby Mode function. 0 : Disabled 1 : Enabled</p>	0 (0, 1)	728
b8-51 (0B01)	Standby Mode Wait Time	<div style="display: flex; justify-content: space-between; gap: 5px;"> V/f CL-V/f OLV CLV AOLV OLV/PM AOLV/PM CLV/PM EZOLV </div> <p>Sets the delay time before turning off the electromagnetic contactor after the drive stops.</p>	600 s (0 - 6000 s)	729

◆ b9: Zero Servo

No. (Hex.)	Name	Description	Default (Range)	Ref.
b9-01 (01DA)	Zero Servo Gain	<div style="display: flex; justify-content: space-between; gap: 5px;"> V/f CL-V/f OLV CLV AOLV OLV/PM AOLV/PM CLV/PM EZOLV </div> <p>Sets the responsiveness for the Zero Servo function.</p>	5 (0 - 100)	730
b9-02 (01DB)	Zero Servo Completion Window	<div style="display: flex; justify-content: space-between; gap: 5px;"> V/f CL-V/f OLV CLV AOLV OLV/PM AOLV/PM CLV/PM EZOLV </div> <p>Sets the range to trigger an output terminal set for "Zero Servo Complete" during Zero Servo operation. Be sure to set the deviation from the Zero Servo start position.</p>	10 (0 - 16383)	730

11.6 C: Tuning

◆ C1: Accel & Decel Time

No. (Hex.)	Name	Description	Default (Range)	Ref.
C1-01 (0200) RUN	Acceleration Time 1	V/f CL-V/f OLV CLV AOLV OLV/PM AOLV/PM CLV/PM EZOLV Sets the length of time to accelerate from zero to maximum output frequency.	10.0 s (0.0 - 6000.0 s)	732
C1-02 (0201) RUN	Deceleration Time 1	V/f CL-V/f OLV CLV AOLV OLV/PM AOLV/PM CLV/PM EZOLV Sets the length of time to decelerate from maximum output frequency to zero.	10.0 s (0.0 - 6000.0 s)	733
C1-03 (0202) RUN	Acceleration Time 2	V/f CL-V/f OLV CLV AOLV OLV/PM AOLV/PM CLV/PM EZOLV Sets the length of time to accelerate from zero to maximum output frequency.	10.0 s (0.0 - 6000.0 s)	733
C1-04 (0203) RUN	Deceleration Time 2	V/f CL-V/f OLV CLV AOLV OLV/PM AOLV/PM CLV/PM EZOLV Sets the length of time to decelerate from maximum output frequency to zero.	10.0 s (0.0 - 6000.0 s)	733
C1-05 (0204) RUN	Acceleration Time 3	V/f CL-V/f OLV CLV AOLV OLV/PM AOLV/PM CLV/PM EZOLV Sets the length of time to accelerate from zero to maximum output frequency.	10.0 s (0.0 - 6000.0 s)	733
C1-06 (0205) RUN	Deceleration Time 3	V/f CL-V/f OLV CLV AOLV OLV/PM AOLV/PM CLV/PM EZOLV Sets the length of time to decelerate from maximum output frequency to zero.	10.0 s (0.0 - 6000.0 s)	733
C1-07 (0206) RUN	Acceleration Time 4	V/f CL-V/f OLV CLV AOLV OLV/PM AOLV/PM CLV/PM EZOLV Sets the length of time to accelerate from zero to maximum output frequency.	10.0 s (0.0 - 6000.0 s)	733
C1-08 (0207) RUN	Deceleration Time 4	V/f CL-V/f OLV CLV AOLV OLV/PM AOLV/PM CLV/PM EZOLV Sets the length of time to decelerate from maximum output frequency to zero.	10.0 s (0.0 - 6000.0 s)	734
C1-09 (0208) RUN	Fast Stop Time	V/f CL-V/f OLV CLV AOLV OLV/PM AOLV/PM CLV/PM EZOLV Sets the length of time that the drive will decelerate to zero for a Fast Stop. Note: • Decelerating too quickly can cause an <i>ov</i> [Overvoltage] fault that shuts off the drive while the motor coasts to a stop. Set a Fast Stop time in C1-09 that prevents motor coasting and makes sure that the motor stops quickly and safely. • When L2-29 = 0 [Kinetic Energy Backup Method = Single Drive KEB Ride-Thru I] and you do KEB Auto-Tuning, the drive will automatically set C1-09. If you must not change the Fast Stop time, do not do KEB Tuning.	10.0 s (0.0 - 6000.0 s)	734
C1-10 (0209)	Accel/Decel Time Setting Units	V/f CL-V/f OLV CLV AOLV OLV/PM AOLV/PM CLV/PM EZOLV Sets the setting units for C1-01 to C1-08 [Accel/Decel Times 1 to 4], C1-09 [Fast Stop Time], L2-06 [Kinetic Energy Backup Decel Time], and L2-07 [Kinetic Energy Backup Accel Time]. 0 : 0.01 s (0.00 to 600.00 s) 1 : 0.1 s (0.0 to 6000.0 s)	1 (0, 1)	734
C1-11 (020A)	Accel/Decel Time Switching Frequency	V/f CL-V/f OLV CLV AOLV OLV/PM AOLV/PM CLV/PM EZOLV Sets the frequency at which the drive will automatically change acceleration and deceleration times.	Determined by A1-02 (0.0 - 590.0 Hz)	734
C1-14 (0264) RUN	Accel/Decel Rate Frequency	V/f CL-V/f OLV CLV AOLV OLV/PM AOLV/PM CLV/PM EZOLV Sets the base frequency used to calculate acceleration and deceleration rates.	0.0 Hz (0.0 - 590.0 Hz)	735

◆ C2: S-Curve Characteristics

No. (Hex.)	Name	Description	Default (Range)	Ref.
C2-01 (020B)	S-Curve Time @ Start of Accel	V/f CL-V/f OLV CLV AOLV OLV/PM AOLV/PM CLV/PM EZOLV Sets the S-curve acceleration time at start.	Determined by A1-02 (0.00 - 10.00 s)	737
C2-02 (020C)	S-Curve Time @ End of Accel	V/f CL-V/f OLV CLV AOLV OLV/PM AOLV/PM CLV/PM EZOLV Sets the S-curve acceleration time at completion.	0.20 s (0.00 - 10.00 s)	737
C2-03 (020D)	S-Curve Time @ Start of Decel	V/f CL-V/f OLV CLV AOLV OLV/PM AOLV/PM CLV/PM EZOLV Sets the S-curve deceleration time at start.	0.20 s (0.00 - 10.00 s)	737
C2-04 (020E)	S-Curve Time @ End of Decel	V/f CL-V/f OLV CLV AOLV OLV/PM AOLV/PM CLV/PM EZOLV Sets the S-curve deceleration time at completion.	0.00 s (0.00 - 10.00 s)	737

◆ C3: Slip Compensation

No. (Hex.)	Name	Description	Default (Range)	Ref.
C3-01 (020F) RUN	Slip Compensation Gain	<p>V/f CL-V/f OLV CLV AOLV OLV/PM AOLV/PM CLV/PM EZOLV</p> <p>Sets the gain for the slip compensation function. Usually it is not necessary to change this setting.</p> <p>Note:</p> <ul style="list-style-type: none"> When $A1-02 = 4$ [AOLV], you cannot change the setting while the drive is running. Correctly set these parameters before you change the slip compensation gain: <ul style="list-style-type: none"> -E2-01 [Motor Rated Current (FLA)] -E2-02 [Motor Rated Slip] -E2-03 [Motor No-Load Current] 	Determined by A1-02 (0.0 - 2.5)	737
C3-02 (0210) RUN	Slip Compensation Delay Time	<p>V/f CL-V/f OLV CLV AOLV OLV/PM AOLV/PM CLV/PM EZOLV</p> <p>Sets the slip compensation delay time when speed is unstable or when the slip compensation response is too slow. Usually it is not necessary to change this setting.</p>	Determined by A1-02 (0 - 10000 ms)	738
C3-03 (0211)	Slip Compensation Limit	<p>V/f CL-V/f OLV CLV AOLV OLV/PM AOLV/PM CLV/PM EZOLV</p> <p>Sets the upper limit for the slip compensation function as a percentage of the motor rated slip.</p>	200% (0 - 250%)	738
C3-04 (0212)	Slip Compensation at Regen	<p>V/f CL-V/f OLV CLV AOLV OLV/PM AOLV/PM CLV/PM EZOLV</p> <p>Sets the slip compensation function during regeneration.</p> <p>0 : Disabled 1 : Enabled Above 6Hz 2 : Enabled Above Defined Range</p>	0 (0 - 2)	738
C3-05 (0213)	Output Voltage Limit Selection	<p>V/f CL-V/f OLV CLV AOLV OLV/PM AOLV/PM CLV/PM EZOLV</p> <p>Sets the automatic reduction of motor magnetic flux when the output voltage is saturated.</p> <p>0 : Disabled 1 : Enabled</p>	0 (0, 1)	739
C3-16 (0261) Expert	Vout Modulation Limit Start Lvl	<p>V/f CL-V/f OLV CLV AOLV OLV/PM AOLV/PM CLV/PM EZOLV</p> <p>Sets the modulation factor that starts the output voltage limit operation when C3-05 = 1 [Output Voltage Limit Selection = Enabled].</p>	90.0% (70.0 - 90.0%)	739
C3-17 (0262) Expert	Vout Modulation Limit Max Level	<p>V/f CL-V/f OLV CLV AOLV OLV/PM AOLV/PM CLV/PM EZOLV</p> <p>Sets the modulation factor used with C3-18 [Output Voltage Limit Level] for the output voltage limit operation when C3-05 = 1 [Output Voltage Limit Selection = Enabled].</p>	100.0% (85.0 - 100.0%)	739
C3-18 (0263) Expert	Output Voltage Limit Level	<p>V/f CL-V/f OLV CLV AOLV OLV/PM AOLV/PM CLV/PM EZOLV</p> <p>Sets the maximum drop width of the voltage reference when C3-05 = 1 [Output Voltage Limit Selection = Enabled].</p>	90.0% (50.0 - 100.0%)	739
C3-21 (033E) RUN	Motor 2 Slip Compensation Gain	<p>V/f CL-V/f OLV CLV AOLV OLV/PM AOLV/PM CLV/PM EZOLV</p> <p>Sets the gain for the motor 2 slip compensation function. Usually it is not necessary to change this setting.</p> <p>Note:</p> <ul style="list-style-type: none"> Correctly set these parameters before changing the slip compensation gain: <ul style="list-style-type: none"> • E4-01 [Motor 2 Rated Current] • E4-02 [Motor 2 Rated Slip] • E4-03 [Motor 2 Rated No-Load Current] 	Determined by E3-01 (0.0 - 2.5)	739
C3-22 (0241) RUN	Motor 2 Slip Comp Delay Time	<p>V/f CL-V/f OLV CLV AOLV OLV/PM AOLV/PM CLV/PM EZOLV</p> <p>Sets the slip compensation delay time for motor 2 when speed is unstable or when the slip compensation response is too slow. Usually it is not necessary to change this setting.</p>	Determined by E3-01 (0 - 10000 ms)	740
C3-23 (0242)	Motor 2 Slip Compensation Limit	<p>V/f CL-V/f OLV CLV AOLV OLV/PM AOLV/PM CLV/PM EZOLV</p> <p>Sets the upper limit for the slip compensation function as a percentage of the motor 2 rated slip.</p>	200% (0 - 250%)	740
C3-24 (0243)	Motor 2 Slip Comp during Regen	<p>V/f CL-V/f OLV CLV AOLV OLV/PM AOLV/PM CLV/PM EZOLV</p> <p>Sets the slip compensation during regenerative operation function for motor 2.</p> <p>0 : Disabled 1 : Enabled Above 6Hz 2 : Enabled Above Defined Range</p>	0 (0 - 2)	740
C3-28 (1B5B) Expert	Adaptive Slip Control Mode	<p>V/f CL-V/f OLV CLV AOLV OLV/PM AOLV/PM CLV/PM EZOLV</p> <p>Sets the slip compensation function mode.</p> <p>0 : Normal 1 : Advanced</p>	0 (0, 1)	741

◆ C4: Torque Compensation

No. (Hex.)	Name	Description	Default (Range)	Ref.
C4-01 (0215) RUN	Torque Compensation Gain	<p>V/f CL-V/f OLV CLV AOLV OLV/PM AOLV/PM CLV/PM EZOLV</p> <p>Sets the gain for the torque compensation function. Use this parameter value for motor 1 when operating multiple motors.</p> <p>Note: If $A1-02 = 8$ [Control Method Selection = EZOLV], you cannot change the setting while the drive is running.</p>	Determined by A1-02 (0.00 - 2.50)	741
C4-02 (0216) RUN	Torque Compensation Delay Time	<p>V/f CL-V/f OLV CLV AOLV OLV/PM AOLV/PM CLV/PM EZOLV</p> <p>Sets the torque compensation delay time. Usually it is not necessary to change this setting.</p> <p>Note:</p> <ul style="list-style-type: none"> When $A1-02 = 5$ [Control Method Selection = OLV/PM], you cannot change the setting while the drive is running. When $A1-02 = 8$ [EZOLV], you cannot change the setting while the drive is running. 	Determined by A1-02 (0 - 60000 ms)	741
C4-03 (0217)	Torque Compensation @ FWD Start	<p>V/f CL-V/f OLV CLV AOLV OLV/PM AOLV/PM CLV/PM EZOLV</p> <p>Set the amount of torque reference for forward start as a percentage of the motor rated torque.</p>	0.0% (0.0 - 200.0%)	742
C4-04 (0218)	Torque Compensation @ REV Start	<p>V/f CL-V/f OLV CLV AOLV OLV/PM AOLV/PM CLV/PM EZOLV</p> <p>Sets the amount of torque reference for reverse start as a percentage of the motor rated torque.</p>	0.0% (-200.0 - 0.0%)	742
C4-05 (0219)	Torque Compensation Time	<p>V/f CL-V/f OLV CLV AOLV OLV/PM AOLV/PM CLV/PM EZOLV</p> <p>Sets the starting torque constant to use with C4-03 and C4-04 [Torque Compensation @ FWD/REV Start].</p>	10 ms (0 - 200 ms)	742
C4-06 (021A)	Motor 2 Torque Comp Delay Time	<p>V/f CL-V/f OLV CLV AOLV OLV/PM AOLV/PM CLV/PM EZOLV</p> <p>Sets the value if <i>ov</i> [Overvoltage] occurs with sudden changes in the load, at the end of acceleration, or at the start of deceleration.</p>	150 ms (0 - 10000 ms)	742
C4-07 (0341) RUN	Motor 2 Torque Compensation Gain	<p>V/f CL-V/f OLV CLV AOLV OLV/PM AOLV/PM CLV/PM EZOLV</p> <p>Sets the gain for motor 2 torque compensation function when using the Motor Switch function.</p>	1.00 (0.00 - 2.50)	742
C4-19 (0B8D) Expert	Torque Ripple Suppress Min Freq	<p>V/f CL-V/f OLV CLV AOLV OLV/PM AOLV/PM CLV/PM EZOLV</p> <p>If there is slow oscillation at low speeds, adjust this setting. Usually it is not necessary to change this setting.</p> <p>Increase this parameter in 1.0 Hz increments when current ripples and torque ripples occur during low-speed operation. Set this parameter to 0.0 to disable the function if increasing the value does not fix the problem.</p>	0.1 Hz (0.0 - 10.0 Hz)	743
C4-20 (0BCB) Expert	Voltage Compensation Adjust 1	<p>V/f CL-V/f OLV CLV AOLV OLV/PM AOLV/PM CLV/PM EZOLV</p> <p>Sets voltage precision compensation. Usually it is not necessary to change this setting.</p>	120 Hz (0 - 200 Hz)	743
C4-21 (0BCC) Expert	Voltage Compensation Adjust 2	<p>V/f CL-V/f OLV CLV AOLV OLV/PM AOLV/PM CLV/PM EZOLV</p> <p>Sets voltage precision compensation. Usually it is not necessary to change this setting.</p>	5 (0 - 10)	743
C4-23 (1583) Expert	Current Control Gain	<p>V/f CL-V/f OLV CLV AOLV OLV/PM AOLV/PM CLV/PM EZOLV</p> <p>Sets the Current control gain. Usually it is not necessary to change this parameter.</p>	1.00 (0.50 - 2.50)	743
C4-25 (1Bf4) Expert	High-Speed Voltage Compensation	<p>V/f CL-V/f OLV CLV AOLV OLV/PM AOLV/PM CLV/PM EZOLV</p> <p>Sets the voltage compensation function for high-speed operation. Usually it is not necessary to change this setting.</p> <p>Note: Set $C4-25 = 0$ when there is audible noise or motor vibration during high-speed operation. 0 : Disabled 1 : Enabled</p>	Determined by A1-02 (0, 1)	743

◆ C5: Auto Speed Regulator (ASR)

No. (Hex.)	Name	Description	Default (Range)	Ref.
C5-01 (021B) RUN	ASR Proportional Gain 1	<p>V/f <input type="checkbox"/> CL-V/f <input type="checkbox"/> OLV <input type="checkbox"/> CLV <input type="checkbox"/> AOLV <input type="checkbox"/> OLV/PM <input type="checkbox"/> AOLV/PM <input type="checkbox"/> CLV/PM <input type="checkbox"/> EZOLV <input type="checkbox"/></p> <p>Sets the gain to adjust ASR response.</p> <p>Note: If $A1-02 = 0$ [Control Method Selection = V/f], you must set $H6-01 = 3$ [Terminal RP Pulse Train Function = Speed Feedback (V/F Control)] to enable this parameter.</p>	Determined by A1-02 (0.00 - 300.00)	747
C5-02 (021C) RUN	ASR Integral Time 1	<p>V/f <input type="checkbox"/> CL-V/f <input type="checkbox"/> OLV <input type="checkbox"/> CLV <input type="checkbox"/> AOLV <input type="checkbox"/> OLV/PM <input type="checkbox"/> AOLV/PM <input type="checkbox"/> CLV/PM <input type="checkbox"/> EZOLV <input type="checkbox"/></p> <p>Sets the ASR integral time.</p> <p>Note: If $A1-02 = 0$ [Control Method Selection = V/f], you must set $H6-01 = 3$ [Terminal RP Pulse Train Function = Speed Feedback (V/F Control)] to enable this parameter.</p>	Determined by A1-02 (0.000 - 60.000 s)	747
C5-03 (021D) RUN	ASR Proportional Gain 2	<p>V/f <input type="checkbox"/> CL-V/f <input type="checkbox"/> OLV <input type="checkbox"/> CLV <input type="checkbox"/> AOLV <input type="checkbox"/> OLV/PM <input type="checkbox"/> AOLV/PM <input type="checkbox"/> CLV/PM <input type="checkbox"/> EZOLV <input type="checkbox"/></p> <p>Sets the gain to adjust ASR response.</p> <p>Note: If $A1-02 = 0$ [Control Method Selection = V/f], you must set $H6-01 = 3$ [Terminal RP Pulse Train Function = Speed Feedback (V/F Control)] to enable this parameter.</p>	Determined by A1-02 (0.00 - 300.00)	747
C5-04 (021E) RUN	ASR Integral Time 2	<p>V/f <input type="checkbox"/> CL-V/f <input type="checkbox"/> OLV <input type="checkbox"/> CLV <input type="checkbox"/> AOLV <input type="checkbox"/> OLV/PM <input type="checkbox"/> AOLV/PM <input type="checkbox"/> CLV/PM <input type="checkbox"/> EZOLV <input type="checkbox"/></p> <p>Sets the ASR integral time.</p> <p>Note: If $A1-02 = 0$ [Control Method Selection = V/f], you must set $H6-01 = 3$ [Terminal RP Pulse Train Function = Speed Feedback (V/F Control)] to enable this parameter.</p>	Determined by A1-02 (0.000 - 60.000 s)	747
C5-05 (021F)	ASR Limit	<p>V/f <input type="checkbox"/> CL-V/f <input type="checkbox"/> OLV <input type="checkbox"/> CLV <input type="checkbox"/> AOLV <input type="checkbox"/> OLV/PM <input type="checkbox"/> AOLV/PM <input type="checkbox"/> CLV/PM <input type="checkbox"/> EZOLV <input type="checkbox"/></p> <p>Set the ASR output limit as a percentage of $E1-04$ [Maximum Output Frequency].</p>	5.0% (0.0 - 20.0%)	748
C5-06 (0220)	ASR Delay Time	<p>V/f <input type="checkbox"/> CL-V/f <input type="checkbox"/> OLV <input type="checkbox"/> CLV <input type="checkbox"/> AOLV <input type="checkbox"/> OLV/PM <input type="checkbox"/> AOLV/PM <input type="checkbox"/> CLV/PM <input type="checkbox"/> EZOLV <input type="checkbox"/></p> <p>Sets the filter time constant of the torque reference output from the speed loop. Usually it is not necessary to change this setting.</p>	Determined by A1-02 (0.000 - 0.500 s)	748
C5-07 (0221)	ASR Gain Switchover Frequency	<p>V/f <input type="checkbox"/> CL-V/f <input type="checkbox"/> OLV <input type="checkbox"/> CLV <input type="checkbox"/> AOLV <input type="checkbox"/> OLV/PM <input type="checkbox"/> AOLV/PM <input type="checkbox"/> CLV/PM <input type="checkbox"/> EZOLV <input type="checkbox"/></p> <p>Sets the frequency where the drive will switch between these parameters: $C5-01$ and $C5-03$ [ASR Proportional Gain 1/2] $C5-02$ and $C5-04$ [ASR Integral Time 1/2]</p>	Determined by A1-02 (Determined by A1-02)	748
C5-08 (0222)	ASR Integral Limit	<p>V/f <input type="checkbox"/> CL-V/f <input type="checkbox"/> OLV <input type="checkbox"/> CLV <input type="checkbox"/> AOLV <input type="checkbox"/> OLV/PM <input type="checkbox"/> AOLV/PM <input type="checkbox"/> CLV/PM <input type="checkbox"/> EZOLV <input type="checkbox"/></p> <p>Set the upper limit of the ASR integral amount as a percentage of the rated load.</p>	400% (0 - 400%)	748
C5-12 (0386)	Integral Operation @ Accel/Decel	<p>V/f <input type="checkbox"/> CL-V/f <input type="checkbox"/> OLV <input type="checkbox"/> CLV <input type="checkbox"/> AOLV <input type="checkbox"/> OLV/PM <input type="checkbox"/> AOLV/PM <input type="checkbox"/> CLV/PM <input type="checkbox"/> EZOLV <input type="checkbox"/></p> <p>Sets ASR integral operation during acceleration and deceleration. 0 : Disabled 1 : Enabled</p> <p>Note: If $A1-02 = 0$ [Control Method Selection = V/f], you must set $H6-01 = 3$ [Terminal RP Pulse Train Function = Speed Feedback (V/F Control)] to enable this parameter.</p>	0 (0, 1)	748
C5-17 (0276) Expert	Motor Inertia	<p>V/f <input type="checkbox"/> CL-V/f <input type="checkbox"/> OLV <input type="checkbox"/> CLV <input type="checkbox"/> AOLV <input type="checkbox"/> OLV/PM <input type="checkbox"/> AOLV/PM <input type="checkbox"/> CLV/PM <input type="checkbox"/> EZOLV <input type="checkbox"/></p> <p>Sets the motor inertia.</p> <p>Note: The display units for the default setting and setting range are different for different models:</p> <ul style="list-style-type: none"> • 0.0001 kgm² units (setting range: 0.0001 kgm² to 6.0000 kgm²): 2004 to 2021, 4002 to 4012 • 0.001 kgm² units (setting range: 0.001 kgm² to 60.000 kgm²): 2030 to 2211, 4018 to 4103 • 0.01 kgm² units (setting range: 0.01 kgm² to 600.00 kgm²): 2257 to 2415, 4140 to 4H12 	Determined by o2-04, C6-01, and E5-01 (0.0001 - 600.00 kgm ²)	749
C5-18 (0277) Expert	Load Inertia Ratio	<p>V/f <input type="checkbox"/> CL-V/f <input type="checkbox"/> OLV <input type="checkbox"/> CLV <input type="checkbox"/> AOLV <input type="checkbox"/> OLV/PM <input type="checkbox"/> AOLV/PM <input type="checkbox"/> CLV/PM <input type="checkbox"/> EZOLV <input type="checkbox"/></p> <p>Sets the load inertia ratio for the motor inertia.</p>	1.0 (0.0 - 6000.0)	749
C5-21 (0356) RUN	Motor 2 ASR Proportional Gain 1	<p>V/f <input type="checkbox"/> CL-V/f <input type="checkbox"/> OLV <input type="checkbox"/> CLV <input type="checkbox"/> AOLV <input type="checkbox"/> OLV/PM <input type="checkbox"/> AOLV/PM <input type="checkbox"/> CLV/PM <input type="checkbox"/> EZOLV <input type="checkbox"/></p> <p>Sets the gain to adjust ASR response for motor 2.</p>	Determined by E3-01 (0.00 - 300.00)	749
C5-22 (0357) RUN	Motor 2 ASR Integral Time 1	<p>V/f <input type="checkbox"/> CL-V/f <input type="checkbox"/> OLV <input type="checkbox"/> CLV <input type="checkbox"/> AOLV <input type="checkbox"/> OLV/PM <input type="checkbox"/> AOLV/PM <input type="checkbox"/> CLV/PM <input type="checkbox"/> EZOLV <input type="checkbox"/></p> <p>Sets the ASR integral time for motor 2.</p>	Determined by E3-01 (0.000 - 60.000 s)	749
C5-23 (0358) RUN	Motor 2 ASR Proportional Gain 2	<p>V/f <input type="checkbox"/> CL-V/f <input type="checkbox"/> OLV <input type="checkbox"/> CLV <input type="checkbox"/> AOLV <input type="checkbox"/> OLV/PM <input type="checkbox"/> AOLV/PM <input type="checkbox"/> CLV/PM <input type="checkbox"/> EZOLV <input type="checkbox"/></p> <p>Sets the gain to adjust ASR response for motor 2.</p>	Determined by E3-01 (0.00 - 300.00)	749

11.6 C: Tuning

No. (Hex.)	Name	Description	Default (Range)	Ref.
C5-24 (0359) RUN	Motor 2 ASR Integral Time 2	<input type="checkbox"/> V/f <input checked="" type="checkbox"/> CL-V/f <input type="checkbox"/> OLV <input checked="" type="checkbox"/> CLV <input type="checkbox"/> AOLV <input type="checkbox"/> OLV/PM <input type="checkbox"/> AOLV/PM <input type="checkbox"/> CLV/PM <input type="checkbox"/> EZOLV Sets the ASR integral time for motor 2.	Determined by E3-01 (0.000 - 60.000 s)	750
C5-25 (035A)	Motor 2 ASR Limit	<input type="checkbox"/> V/f <input checked="" type="checkbox"/> CL-V/f <input type="checkbox"/> OLV <input checked="" type="checkbox"/> CLV <input type="checkbox"/> AOLV <input type="checkbox"/> OLV/PM <input type="checkbox"/> AOLV/PM <input type="checkbox"/> CLV/PM <input type="checkbox"/> EZOLV Set the motor 2 ASR output limit as a percentage of E1-04 [Maximum Output Frequency].	5.0% (0.0 - 20.0%)	750
C5-26 (035B)	Motor 2 ASR Delay Time	<input type="checkbox"/> V/f <input checked="" type="checkbox"/> CL-V/f <input type="checkbox"/> OLV <input checked="" type="checkbox"/> CLV <input type="checkbox"/> AOLV <input type="checkbox"/> OLV/PM <input type="checkbox"/> AOLV/PM <input type="checkbox"/> CLV/PM <input type="checkbox"/> EZOLV Sets the motor 2 filter time constant of the torque reference output from the speed loop. Usually it is not necessary to change this setting.	Determined by E3-01 (0.000 - 0.500 s)	750
C5-27 (035C)	Motor 2 ASR Gain Switchover Freq	<input type="checkbox"/> V/f <input checked="" type="checkbox"/> CL-V/f <input type="checkbox"/> OLV <input checked="" type="checkbox"/> CLV <input type="checkbox"/> AOLV <input type="checkbox"/> OLV/PM <input type="checkbox"/> AOLV/PM <input type="checkbox"/> CLV/PM <input type="checkbox"/> EZOLV Sets the frequency where the drive will switch between these parameters: C5-21 and C5-23 [Motor 2 ASR Proportional Gain 1/2] C5-22 and C5-24 [Motor 2 ASR Integral Time 1/2]	0.0 (0.0 - 400.0)	750
C5-28 (035D)	Motor 2 ASR Integral Limit	<input type="checkbox"/> V/f <input checked="" type="checkbox"/> CL-V/f <input type="checkbox"/> OLV <input checked="" type="checkbox"/> CLV <input type="checkbox"/> AOLV <input type="checkbox"/> OLV/PM <input type="checkbox"/> AOLV/PM <input type="checkbox"/> CLV/PM <input type="checkbox"/> EZOLV Set the upper limit of the motor 2 ASR integral amount as a percentage of the rated load.	400% (0 - 400%)	750
C5-29 (0B18) Expert	Speed Control Response	<input checked="" type="checkbox"/> V/f <input checked="" type="checkbox"/> CL-V/f <input checked="" type="checkbox"/> OLV <input checked="" type="checkbox"/> CLV <input type="checkbox"/> AOLV <input type="checkbox"/> OLV/PM <input type="checkbox"/> AOLV/PM <input type="checkbox"/> CLV/PM <input type="checkbox"/> EZOLV Sets the level of speed control responsiveness. Usually it is not necessary to change this setting. 0 : Standard 1 : High Performance 1	0 (0, 1)	751
C5-32 (0361)	Motor 2 Integral Oper at Acc/Dec	<input type="checkbox"/> V/f <input checked="" type="checkbox"/> CL-V/f <input type="checkbox"/> OLV <input checked="" type="checkbox"/> CLV <input type="checkbox"/> AOLV <input type="checkbox"/> OLV/PM <input type="checkbox"/> AOLV/PM <input type="checkbox"/> CLV/PM <input type="checkbox"/> EZOLV Sets ASR integral operation during acceleration and deceleration for motor 2. 0 : Disabled 1 : Enabled	0 (0, 1)	751
C5-37 (0278) Expert	Motor 2 Inertia	<input type="checkbox"/> V/f <input checked="" type="checkbox"/> CL-V/f <input type="checkbox"/> OLV <input checked="" type="checkbox"/> CLV <input type="checkbox"/> AOLV <input type="checkbox"/> OLV/PM <input type="checkbox"/> AOLV/PM <input type="checkbox"/> CLV/PM <input type="checkbox"/> EZOLV Sets the motor inertia for motor 2. Note: The display units for the default setting and setting range are different for different models: • 0.0001 kgm ² units (setting range: 0.0001 kgm ² to 6.0000 kgm ²): 2004 to 2021, 4002 to 4012 • 0.001 kgm ² units (setting range: 0.001 kgm ² to 60.000 kgm ²): 2030 to 2211, 4018 to 4103 • 0.01 kgm ² units (setting range: 0.01 kgm ² to 600.00 kgm ²): 2257 to 2415, 4140 to 4H12	Determined by o2-04, C6-01 (0.0001 - 600.00 kgm ²)	751
C5-38 (0279) Expert	Motor 2 Load Inertia Ratio	<input type="checkbox"/> V/f <input checked="" type="checkbox"/> CL-V/f <input type="checkbox"/> OLV <input checked="" type="checkbox"/> CLV <input type="checkbox"/> AOLV <input type="checkbox"/> OLV/PM <input type="checkbox"/> AOLV/PM <input type="checkbox"/> CLV/PM <input type="checkbox"/> EZOLV Sets the load inertia ratio for the motor 2 inertia.	1.0 (0.0 - 6000.0)	751
C5-39 (030D)	ASR Primary Delay Time Const 2	<input type="checkbox"/> V/f <input checked="" type="checkbox"/> CL-V/f <input type="checkbox"/> OLV <input checked="" type="checkbox"/> CLV <input type="checkbox"/> AOLV <input type="checkbox"/> OLV/PM <input checked="" type="checkbox"/> AOLV/PM <input type="checkbox"/> CLV/PM <input type="checkbox"/> EZOLV Sets the filter time constant used when the torque reference is output from ASR. Usually it is not necessary to change this parameter.	0.000 s (0.000 - 0.500 s)	751
C5-50 (0B14) Expert	Notch Filter Frequency	<input type="checkbox"/> V/f <input checked="" type="checkbox"/> CL-V/f <input type="checkbox"/> OLV <input checked="" type="checkbox"/> CLV <input type="checkbox"/> AOLV <input type="checkbox"/> OLV/PM <input type="checkbox"/> AOLV/PM <input type="checkbox"/> CLV/PM <input type="checkbox"/> EZOLV Sets the machine resonance frequency. Note: Set C5-50 = 0 [0 Hz] to disable the notch filter.	0 Hz (0, or 2 to 100 Hz)	752
C5-51 (0B15) Expert	Notch Filter Bandwidth	<input type="checkbox"/> V/f <input checked="" type="checkbox"/> CL-V/f <input type="checkbox"/> OLV <input checked="" type="checkbox"/> CLV <input type="checkbox"/> AOLV <input type="checkbox"/> OLV/PM <input type="checkbox"/> AOLV/PM <input type="checkbox"/> CLV/PM <input type="checkbox"/> EZOLV Sets the notch width of the notch filter. Note: Set C5-50 = 0 [Notch Filter Frequency = 0 Hz] to disable the notch filter.	1.0 (0.5 - 5.0)	752

◆ C6: Duty & Carrier Frequency

No. (Hex.)	Name	Description	Default (Range)	Ref.
C6-01 (0223)	Normal / Heavy Duty Selection	<p>V/f CL-V/f OLV CLV AOLV OLV/PM AOLV/PM CLV/PM EZOLV</p> <p>Sets the drive duty rating. 0 : Heavy Duty Rating 1 : Normal Duty Rating</p>	0 (0, 1)	752
C6-02 (0224)	Carrier Frequency Selection	<p>V/f CL-V/f OLV CLV AOLV OLV/PM AOLV/PM CLV/PM EZOLV</p> <p>Sets the carrier frequency for the transistors in the drive. 1 : 2.0 kHz 2 : 5.0 kHz (4.0 kHz for AOLV/PM) 3 : 8.0 kHz (6.0 kHz for AOLV/PM) 4 : 10.0 kHz (8.0 kHz for AOLV/PM) 5 : 12.5 kHz (10.0 kHz for AOLV/PM) 6 : 15.0 kHz (12.0 kHz for AOLV/PM) 7 : Swing PWM4 (Audible Sound 1) 8 : Swing PWM4 (Audible Sound 2) 9 : Swing PWM4 (Audible Sound 3) A : Swing PWM4 (Audible Sound 4) F : User Defined (C6-03 to C6-05)</p> <p>Note: The carrier frequency for Swing PWM 1 to 4 is equivalent to 2.0 kHz.</p>	Determined by A1-02, C6-01, and o2-04 (Determined by A1-02)	753
C6-03 (0225)	Carrier Frequency Upper Limit	<p>V/f CL-V/f OLV CLV AOLV OLV/PM AOLV/PM CLV/PM EZOLV</p> <p>Sets the upper limit of the carrier frequency. Set $C6-02 = F$ [Carrier Frequency Selection = User Defined (C6-03 to C6-05)] to set this parameter.</p>	Determined by C6-02 (1.0 - 15.0 kHz)	754
C6-04 (0226)	Carrier Frequency Lower Limit	<p>V/f CL-V/f OLV CLV AOLV OLV/PM AOLV/PM CLV/PM EZOLV</p> <p>Sets the lower limit of the carrier frequency. Set $C6-02 = F$ [Carrier Frequency Selection = User Defined (C6-03 to C6-05)] to set this parameter.</p>	Determined by C6-02 (1.0 - 15.0 kHz)	755
C6-05 (0227)	Carrier Freq Proportional Gain	<p>V/f CL-V/f OLV CLV AOLV OLV/PM AOLV/PM CLV/PM EZOLV</p> <p>Sets the proportional gain for the carrier frequency. Set $C6-02 = F$ [Carrier Frequency Selection = User Defined (C6-03 to C6-05)] to set this parameter.</p>	Determined by C6-02 (0 - 99)	755
C6-09 (022B)	Carrier Freq at Rotational Tune	<p>V/f CL-V/f OLV CLV AOLV OLV/PM AOLV/PM CLV/PM EZOLV</p> <p>Sets the Auto-Tuning carrier frequency. Usually it is not necessary to change this setting. 0 : 5kHz 1 : use C6-03</p>	0 (0, 1)	755

11.7 d: Reference Settings

◆ d1: Frequency Reference

No. (Hex.)	Name	Description	Default (Range)	Ref.
d1-01 (0280) RUN	Reference 1	<p>V/f CL-V/f OLV CLV AOLV OLV/PM AOLV/PM CLV/PM EZOLV</p> <p>Sets the frequency reference in the units from o1-03 [Frequency Display Unit Selection].</p> <p>Note: When A1-02 = 6, 7 [Control Method Selection = AOLV/PM, CLV/PM], the drive changes o1-03 = 1 [0.01% (100% = E1-04)].</p>	0.00 Hz (0.00 - 590.00 Hz)	758
d1-02 (0281) RUN	Reference 2	<p>V/f CL-V/f OLV CLV AOLV OLV/PM AOLV/PM CLV/PM EZOLV</p> <p>Sets the frequency reference in the units from o1-03 [Frequency Display Unit Selection].</p> <p>Note: When A1-02 = 6, 7 [Control Method Selection = AOLV/PM, CLV/PM], the drive changes o1-03 = 1 [0.01% (100% = E1-04)].</p>	0.00 Hz (0.00 - 590.00 Hz)	758
d1-03 (0282) RUN	Reference 3	<p>V/f CL-V/f OLV CLV AOLV OLV/PM AOLV/PM CLV/PM EZOLV</p> <p>Sets the frequency reference in the units from o1-03 [Frequency Display Unit Selection].</p> <p>Note: When A1-02 = 6, 7 [Control Method Selection = AOLV/PM, CLV/PM], the drive changes o1-03 = 1 [0.01% (100% = E1-04)].</p>	0.00 Hz (0.00 - 590.00 Hz)	759
d1-04 (0283) RUN	Reference 4	<p>V/f CL-V/f OLV CLV AOLV OLV/PM AOLV/PM CLV/PM EZOLV</p> <p>Sets the frequency reference in the units from o1-03 [Frequency Display Unit Selection].</p> <p>Note: When A1-02 = 6, 7 [Control Method Selection = AOLV/PM, CLV/PM], the drive changes o1-03 = 1 [0.01% (100% = E1-04)].</p>	0.00 Hz (0.00 - 590.00 Hz)	759
d1-05 (0284) RUN	Reference 5	<p>V/f CL-V/f OLV CLV AOLV OLV/PM AOLV/PM CLV/PM EZOLV</p> <p>Sets the frequency reference in the units from o1-03 [Frequency Display Unit Selection].</p> <p>Note: When A1-02 = 6, 7 [Control Method Selection = AOLV/PM, CLV/PM], the drive changes o1-03 = 1 [0.01% (100% = E1-04)].</p>	0.00 Hz (0.00 - 590.00 Hz)	759
d1-06 (0285) RUN	Reference 6	<p>V/f CL-V/f OLV CLV AOLV OLV/PM AOLV/PM CLV/PM EZOLV</p> <p>Sets the frequency reference in the units from o1-03 [Frequency Display Unit Selection].</p> <p>Note: When A1-02 = 6, 7 [Control Method Selection = AOLV/PM, CLV/PM], the drive changes o1-03 = 1 [0.01% (100% = E1-04)].</p>	0.00 Hz (0.00 - 590.00 Hz)	759
d1-07 (0286) RUN	Reference 7	<p>V/f CL-V/f OLV CLV AOLV OLV/PM AOLV/PM CLV/PM EZOLV</p> <p>Sets the frequency reference in the units from o1-03 [Frequency Display Unit Selection].</p> <p>Note: When A1-02 = 6, 7 [Control Method Selection = AOLV/PM, CLV/PM], the drive changes o1-03 = 1 [0.01% (100% = E1-04)].</p>	0.00 Hz (0.00 - 590.00 Hz)	760
d1-08 (0287) RUN	Reference 8	<p>V/f CL-V/f OLV CLV AOLV OLV/PM AOLV/PM CLV/PM EZOLV</p> <p>Sets the frequency reference in the units from o1-03 [Frequency Display Unit Selection].</p> <p>Note: When A1-02 = 6, 7 [Control Method Selection = AOLV/PM, CLV/PM], the drive changes o1-03 = 1 [0.01% (100% = E1-04)].</p>	0.00 Hz (0.00 - 590.00 Hz)	760
d1-09 (0288) RUN	Reference 9	<p>V/f CL-V/f OLV CLV AOLV OLV/PM AOLV/PM CLV/PM EZOLV</p> <p>Sets the frequency reference in the units from o1-03 [Frequency Display Unit Selection].</p> <p>Note: When A1-02 = 6, 7 [Control Method Selection = AOLV/PM, CLV/PM], the drive changes o1-03 = 1 [0.01% (100% = E1-04)].</p>	0.00 Hz (0.00 - 590.00 Hz)	760
d1-10 (028B) RUN	Reference 10	<p>V/f CL-V/f OLV CLV AOLV OLV/PM AOLV/PM CLV/PM EZOLV</p> <p>Sets the frequency reference in the units from o1-03 [Frequency Display Unit Selection].</p> <p>Note: When A1-02 = 6, 7 [Control Method Selection = AOLV/PM, CLV/PM], the drive changes o1-03 = 1 [0.01% (100% = E1-04)].</p>	0.00 Hz (0.00 - 590.00 Hz)	760
d1-11 (028C) RUN	Reference 11	<p>V/f CL-V/f OLV CLV AOLV OLV/PM AOLV/PM CLV/PM EZOLV</p> <p>Sets the frequency reference in the units from o1-03 [Frequency Display Unit Selection].</p> <p>Note: When A1-02 = 6, 7 [Control Method Selection = AOLV/PM, CLV/PM], the drive changes o1-03 = 1 [0.01% (100% = E1-04)].</p>	0.00 Hz (0.00 - 590.00 Hz)	760

No. (Hex.)	Name	Description	Default (Range)	Ref.
d1-12 (028D) RUN	Reference 12	<p>V/f CL-V/f OLV CLV AOLV OLV/PM AOLV/PM CLV/PM EZOLV</p> <p>Sets the frequency reference in the units from o1-03 [Frequency Display Unit Selection].</p> <p>Note: When A1-02 = 6, 7 [Control Method Selection = AOLV/PM, CLV/PM], the drive changes o1-03 = 1 [0.01% (100% = E1-04)].</p>	0.00 Hz (0.00 - 590.00 Hz)	761
d1-13 (028E) RUN	Reference 13	<p>V/f CL-V/f OLV CLV AOLV OLV/PM AOLV/PM CLV/PM EZOLV</p> <p>Sets the frequency reference in the units from o1-03 [Frequency Display Unit Selection].</p> <p>Note: When A1-02 = 6, 7 [Control Method Selection = AOLV/PM, CLV/PM], the drive changes o1-03 = 1 [0.01% (100% = E1-04)].</p>	0.00 Hz (0.00 - 590.00 Hz)	761
d1-14 (028F) RUN	Reference 14	<p>V/f CL-V/f OLV CLV AOLV OLV/PM AOLV/PM CLV/PM EZOLV</p> <p>Sets the frequency reference in the units from o1-03 [Frequency Display Unit Selection].</p> <p>Note: When A1-02 = 6, 7 [Control Method Selection = AOLV/PM, CLV/PM], the drive changes o1-03 = 1 [0.01% (100% = E1-04)].</p>	0.00 Hz (0.00 - 590.00 Hz)	761
d1-15 (0290) RUN	Reference 15	<p>V/f CL-V/f OLV CLV AOLV OLV/PM AOLV/PM CLV/PM EZOLV</p> <p>Sets the frequency reference in the units from o1-03 [Frequency Display Unit Selection].</p> <p>Note: When A1-02 = 6, 7 [Control Method Selection = AOLV/PM, CLV/PM], the drive changes o1-03 = 1 [0.01% (100% = E1-04)].</p>	0.00 Hz (0.00 - 590.00 Hz)	761
d1-16 (0291) RUN	Reference 16	<p>V/f CL-V/f OLV CLV AOLV OLV/PM AOLV/PM CLV/PM EZOLV</p> <p>Sets the frequency reference in the units from o1-03 [Frequency Display Unit Selection].</p> <p>Note: When A1-02 = 6, 7 [Control Method Selection = AOLV/PM, CLV/PM], the drive changes o1-03 = 1 [0.01% (100% = E1-04)].</p>	0.00 Hz (0.00 - 590.00 Hz)	761
d1-17 (0292) RUN	Jog Reference	<p>V/f CL-V/f OLV CLV AOLV OLV/PM AOLV/PM CLV/PM EZOLV</p> <p>Sets the Jog frequency reference in the units from o1-03 [Frequency Display Unit Selection]. Set H1-xx = 6 [MFDI Function Select = Jog Reference Selection] to use the Jog frequency reference.</p> <p>Note: When A1-02 = 6, 7 [Control Method Selection = AOLV/PM, CLV/PM], the drive sets o1-03 = 1 [0.01% (100% = E1-04)].</p>	6.00 Hz (0.00 - 590.00 Hz)	762

◆ d2: Reference Limits

No. (Hex.)	Name	Description	Default (Range)	Ref.
d2-01 (0289)	Frequency Reference Upper Limit	<p>V/f CL-V/f OLV CLV AOLV OLV/PM AOLV/PM CLV/PM EZOLV</p> <p>Sets maximum limit for all frequency references. The maximum output frequency is 100%.</p> <p>Note: Parameter A1-02 [Control Method Selection] selects which parameter is the maximum output frequency. • A1-02 ≠ 8 [EZOLV]: E1-04 [Maximum Output Frequency] • A1-02 = 8: E9-02 [Motor Max Revolutions]</p>	100.0% (0.0 - 110.0%)	762
d2-02 (028A)	Frequency Reference Lower Limit	<p>V/f CL-V/f OLV CLV AOLV OLV/PM AOLV/PM CLV/PM EZOLV</p> <p>Sets minimum limit for all frequency references. The maximum output frequency is 100%.</p> <p>Note: Parameter A1-02 [Control Method Selection] selects which parameter is the maximum output frequency. • A1-02 ≠ 8 [EZOLV]: E1-04 [Maximum Output Frequency] • A1-02 = 8: E9-02 [Motor Max Revolutions]</p>	0.0% (0.0 - 110.0%)	762
d2-03 (0293)	Analog Frequency Ref Lower Limit	<p>V/f CL-V/f OLV CLV AOLV OLV/PM AOLV/PM CLV/PM EZOLV</p> <p>Sets the lower limit for the master frequency reference (the first frequency of the multi-step speed reference) as a percentage. The maximum output frequency is 100%.</p> <p>Note: Parameter A1-02 [Control Method Selection] selects which parameter is the maximum output frequency. • A1-02 ≠ 8: E1-04 [Maximum Output Frequency] • A1-02 = 8: E9-02 [Maximum Speed]</p>	0.0% (0.0 - 110.0%)	762

◆ d3: Jump Frequency

No. (Hex.)	Name	Description	Default (Range)	Ref.
d3-01 (0294)	Jump Frequency 1	V/f CL-V/f OLV CLV AOLV OLV/PM AOLV/PM CLV/PM EZOLV Sets the median value of the frequency band that the drive will avoid.	0.0 Hz (Determined by A1-02)	763
d3-02 (0295)	Jump Frequency 2	V/f CL-V/f OLV CLV AOLV OLV/PM AOLV/PM CLV/PM EZOLV Sets the median value of the frequency band that the drive will avoid.	0.0 Hz (Determined by A1-02)	763
d3-03 (0296)	Jump Frequency 3	V/f CL-V/f OLV CLV AOLV OLV/PM AOLV/PM CLV/PM EZOLV Sets the median value of the frequency band that the drive will avoid.	0.0 Hz (Determined by A1-02)	764
d3-04 (0297)	Jump Frequency Width	V/f CL-V/f OLV CLV AOLV OLV/PM AOLV/PM CLV/PM EZOLV Sets the width of the frequency band that the drive will avoid.	1.0 Hz (Determined by A1-02)	764

◆ d4: Frequency Ref Up/Down & Hold

No. (Hex.)	Name	Description	Default (Range)	Ref.
d4-01 (0298)	Freq Reference Hold Selection	V/f CL-V/f OLV CLV AOLV OLV/PM AOLV/PM CLV/PM EZOLV Sets the function that saves the frequency reference or the frequency bias (Up/Down 2) after a Stop command or when de-energizing the drive. Set <i>H1-xx</i> [MFDI Function Selection] to one of these values to enable this parameter: • <i>A</i> [Accel/Decel Ramp Hold] • <i>10/11</i> [Up/Down Command] • <i>75/76</i> [Up/Down 2 Command] 0 : Disabled 1 : Enabled	0 (0, 1)	764
d4-03 (02AA) RUN	Up/Down 2 Bias Step Frequency	V/f CL-V/f OLV CLV AOLV OLV/PM AOLV/PM CLV/PM EZOLV Sets the bias that the Up/Down 2 function adds to or subtracts from the frequency reference.	0.00 Hz (0.00 - 99.99 Hz)	766
d4-04 (02AB) RUN	Up/Down 2 Ramp Selection	V/f CL-V/f OLV CLV AOLV OLV/PM AOLV/PM CLV/PM EZOLV Sets the acceleration and deceleration times for the Up/Down 2 function to apply the bias to the frequency reference. 0 : Use Selected Accel/Decel Time 1 : Use Accel/Decel Time 4	0 (0, 1)	767
d4-05 (02AC) RUN	Up/Down 2 Bias Mode Selection	V/f CL-V/f OLV CLV AOLV OLV/PM AOLV/PM CLV/PM EZOLV Sets the function that saves the bias value to the drive when you open or close the two Up/Down 2 Commands [<i>H1-xx</i> = 75, 76]. Set <i>d4-03</i> [Up/Down 2 Bias Step Frequency] = 0.00 before you set this parameter. 0 : Hold when Neither Up/Down Closed 1 : Reset when Neither / Both Closed	0 (0, 1)	767
d4-06 (02AD)	Frequency Ref Bias (Up/Down 2)	V/f CL-V/f OLV CLV AOLV OLV/PM AOLV/PM CLV/PM EZOLV Saves the bias value from the Up/Down 2 Command where the Maximum Output Frequency is 100%. Note: Parameter <i>A1-02</i> [Control Method Selection] selects which parameter is the maximum output frequency. • <i>A1-02</i> ≠ 8 [EZOLV]: <i>E1-04</i> [Maximum Output Frequency] • <i>A1-02</i> = 8: <i>E9-02</i> [Maximum Speed]	0.0% (-99.9 - +100.0%)	767
d4-07 (02AE) RUN	Analog Freq Ref Fluctuate Limit	V/f CL-V/f OLV CLV AOLV OLV/PM AOLV/PM CLV/PM EZOLV If the frequency reference changes for more than the level set to this parameter, then the bias value will be held. The value is set as a percentage of the Maximum Output Frequency. Note: Parameter <i>A1-02</i> [Control Method Selection] selects which parameter is the maximum output frequency. • <i>A1-02</i> ≠ 8 [EZOLV]: <i>E1-04</i> [Maximum Output Frequency] • <i>A1-02</i> = 8: <i>E9-02</i> [Maximum Speed]	1.0% (0.1 - 100.0%)	768
d4-08 (02AF) RUN	Up/Down 2 Bias Upper Limit	V/f CL-V/f OLV CLV AOLV OLV/PM AOLV/PM CLV/PM EZOLV Sets the upper limit of the Up/Down 2 bias as a percentage of the Maximum Output Frequency. Note: Parameter <i>A1-02</i> [Control Method Selection] selects which parameter is the maximum output frequency. • <i>A1-02</i> ≠ 8 [EZOLV]: <i>E1-04</i> [Maximum Output Frequency] • <i>A1-02</i> = 8: <i>E9-02</i> [Maximum Speed]	100.0% (0.0 - 100.0%)	768

No. (Hex.)	Name	Description	Default (Range)	Ref.
d4-09 (02B0) RUN	Up/Down 2 Bias Lower Limit	V/f CL-V/f OLV CLV AOLV OLV/PM AOLV/PM CLV/PM EZOLV Sets the lower limit of the Up/Down 2 bias as a percentage of the Maximum Output Frequency. Note: Parameter <i>A1-02</i> [Control Method Selection] selects which parameter is the maximum output frequency. • <i>A1-02</i> ≠ 8 [EZOLV]: <i>E1-04</i> [Maximum Output Frequency] • <i>A1-02</i> = 8: <i>E9-02</i> [Maximum Speed]	0.0% (-99.9 - 0.0%)	768
d4-10 (02B6)	Up/Down Freq Lower Limit Select	V/f CL-V/f OLV CLV AOLV OLV/PM AOLV/PM CLV/PM EZOLV Sets the lower frequency limit for the Up/Down function. 0 : Greater of d2-02 or Analog 1 : d2-02	0 (0, 1)	768
d4-11 (02B7)	Bi-directional Output Selection	V/f CL-V/f OLV CLV AOLV OLV/PM AOLV/PM CLV/PM EZOLV Sets the function that changes the frequency reference to a Bi-Directional internal frequency reference. 0 : Disabled 1 : Enabled	0 (0, 1)	769
d4-12 (02B8)	Stop Position Gain	V/f CL-V/f OLV CLV AOLV OLV/PM AOLV/PM CLV/PM EZOLV Sets the gain to adjust the stopping accuracy. Set this parameter when <i>b1-03</i> = 9 [Stopping Method Selection = Stop with Constant Distance].	1.00 (0.50 - 2.55)	770

◆ d5: Torque Control

No. (Hex.)	Name	Description	Default (Range)	Ref.
d5-01 (029A)	Torque Control Selection	V/f CL-V/f OLV CLV AOLV OLV/PM AOLV/PM CLV/PM EZOLV Sets the drive for torque control or speed control. 0 : Speed Control 1 : Torque Control	0 (0, 1)	774
d5-02 (029B)	Torque Reference Delay Time	V/f CL-V/f OLV CLV AOLV OLV/PM AOLV/PM CLV/PM EZOLV Sets the primary delay time constant for the torque reference filter.	Determined by A1-02 (0 - 1000 ms)	774
d5-03 (029C)	Speed Limit Selection	V/f CL-V/f OLV CLV AOLV OLV/PM AOLV/PM CLV/PM EZOLV Sets the torque control speed limit method. 1 : Active Frequency Reference 2 : d5-04 Setting	1 (1, 2)	774
d5-04 (029D)	Speed Limit	V/f CL-V/f OLV CLV AOLV OLV/PM AOLV/PM CLV/PM EZOLV Sets the speed limit during Torque Control as a percentage of <i>E1-04</i> [Maximum Output Frequency]. Set <i>d5-03</i> = 2 [Speed Limit Selection = d5-04 Setting] before you set this parameter.	0% (-120 - +120%)	775
d5-05 (029E)	Speed Limit Bias	V/f CL-V/f OLV CLV AOLV OLV/PM AOLV/PM CLV/PM EZOLV Sets the speed limit bias value as a percentage of <i>E1-04</i> [Maximum Output Frequency].	10% (0 - 120%)	775
d5-06 (029F)	Speed/Torque Changeover Time	V/f CL-V/f OLV CLV AOLV OLV/PM AOLV/PM CLV/PM EZOLV Sets the delay time to switch between Speed Control and Torque Control. Set <i>H1-xx</i> = 71 [MFDI Function Selection = Torque Control] before you set this parameter.	0 ms (0 - 1000 ms)	775
d5-08 (02B5)	Uni-directional Speed Limit Bias	V/f CL-V/f OLV CLV AOLV OLV/PM AOLV/PM CLV/PM EZOLV Sets the direction of the speed limit reference to which Speed Limit Bias [d5-05] applies. 0 : Disabled 1 : Enabled	1 (0, 1)	775

◆ d6: Field Weakening /Forcing

No. (Hex.)	Name	Description	Default (Range)	Ref.
d6-01 (02A0)	Field Weakening Level	V/f CL-V/f OLV CLV AOLV OLV/PM AOLV/PM CLV/PM EZOLV Sets the drive output voltage as a percentage of <i>E1-05</i> [Maximum Output Voltage] when <i>H1-xx</i> = 63 [Field Weakening] is activated.	80% (0 - 100%)	776
d6-02 (02A1)	Field Weakening Frequency Limit	V/f CL-V/f OLV CLV AOLV OLV/PM AOLV/PM CLV/PM EZOLV Sets the minimum output frequency to start field weakening.	0.0 Hz (0.0 - 590.0 Hz)	776

11.7 d: Reference Settings

No. (Hex.)	Name	Description	Default (Range)	Ref.
d6-03 (02A2)	Field Forcing Selection	<p>V/f CL-V/f OLV CLV AOLV OLV/PM AOLV/PM CLV/PM EZOLV</p> <p>Sets the field forcing function. 0 : Disabled 1 : Enabled</p>	0 (0, 1)	776
d6-06 (02A5)	Field Forcing Limit	<p>V/f CL-V/f OLV CLV AOLV OLV/PM AOLV/PM CLV/PM EZOLV</p> <p>Sets the limit value for field forcing to increase the motor excitation current reference as a percentage of <i>E2-03 [Motor No-Load Current]</i>. Usually it is not necessary to change this setting.</p>	400% (100 - 400%)	776

◆ d7: Offset Frequency

No. (Hex.)	Name	Description	Default (Range)	Ref.
d7-01 (02B2) RUN	Offset Frequency 1	<p>V/f CL-V/f OLV CLV AOLV OLV/PM AOLV/PM CLV/PM EZOLV</p> <p>Uses <i>H1-xx = 44 [MFDI Function Select = Add Offset Frequency 1 (d7-01)]</i> as a percentage of the Maximum Output Frequency to add or subtract the set frequency to/from the frequency reference.</p> <p>Note: Parameter <i>A1-02 [Control Method Selection]</i> selects which parameter is the maximum output frequency. • <i>A1-02 ≠ 8 [EZOLV]: E1-04 [Maximum Output Frequency]</i> • <i>A1-02 = 8: E9-02 [Maximum Speed]</i></p>	0.0% (-100.0 - +100.0%)	777
d7-02 (02B3) RUN	Offset Frequency 2	<p>V/f CL-V/f OLV CLV AOLV OLV/PM AOLV/PM CLV/PM EZOLV</p> <p>Uses <i>H1-xx = 45 [MFDI Function Select = Add Offset Frequency 2 (d7-02)]</i> as a percentage of the Maximum Output Frequency to add or subtract the set frequency to/from the frequency reference.</p> <p>Note: Parameter <i>A1-02 [Control Method Selection]</i> selects which parameter is the maximum output frequency. • <i>A1-02 ≠ 8 [EZOLV]: E1-04 [Maximum Output Frequency]</i> • <i>A1-02 = 8: E9-02 [Maximum Speed]</i></p>	0.0% (-100.0 - +100.0%)	777
d7-03 (02B4) RUN	Offset Frequency 3	<p>V/f CL-V/f OLV CLV AOLV OLV/PM AOLV/PM CLV/PM EZOLV</p> <p>Uses <i>H1-xx = 46 [MFDI Function Select = Add Offset Frequency 3 (d7-03)]</i> as a percentage of the Maximum Output Frequency to add or subtract the set frequency to/from the frequency reference.</p> <p>Note: Parameter <i>A1-02 [Control Method Selection]</i> selects which parameter is the maximum output frequency. • <i>A1-02 ≠ 8 [EZOLV]: E1-04 [Maximum Output Frequency]</i> • <i>A1-02 = 8: E9-02 [Maximum Speed]</i></p>	0.0% (-100.0 - +100.0%)	777

11.8 E: Motor Parameters

◆ E1: V/f Pattern for Motor 1

No. (Hex.)	Name	Description	Default (Range)	Ref.
E1-01 (0300)	Input AC Supply Voltage	<p>V/f CL-V/f OLV CLV AOLV OLV/PM AOLV/PM CLV/PM EZOLV</p> <p>Sets the drive input voltage.</p> <p>NOTICE: Damage to Equipment. Set E1-01 [Input AC Supply Voltage] to align with the drive input voltage (not motor voltage). If this parameter is incorrect, the protective functions of the drive will not operate correctly and it can cause damage to the drive.</p>	200 V Class: 230 V, 400 V Class: 400 V (200 V Class: 155 to 255 V, 400 V Class: 310 to 510 V)	779
E1-03 (0302)	V/f Pattern Selection	<p>V/f CL-V/f OLV CLV AOLV OLV/PM AOLV/PM CLV/PM EZOLV</p> <p>Sets the V/f pattern for the drive and motor. You can use one of the preset patterns or you can make a custom pattern.</p> <p>0 : Const Trq, 50Hz base, 50Hz max 1 : Const Trq, 60Hz base, 60Hz max 2 : Const Trq, 50Hz base, 60Hz max 3 : Const Trq, 60Hz base, 72Hz max 4 : VT, 50Hz, 65% Vmid reduction 5 : VT, 50Hz, 50% Vmid reduction 6 : VT, 60 Hz, 65% Vmid reduction 7 : VT, 60Hz, 50% Vmid reduction 8 : High Trq, 50Hz, 25% Vmin boost 9 : High Trq, 50Hz, 65% Vmin boost A : High Trq, 60Hz, 25% Vmin boost B : High Trq, 60Hz, 65% Vmin boost C : High Freq, 60Hz base, 90Hz max D : High Freq, 60Hz base, 120Hz max E : High Freq, 60Hz base, 180Hz max F : Custom</p> <p>Note:</p> <ul style="list-style-type: none"> When A1-02 = 2 [Control Method Selection = OLV], settings 0 to E are not available. Set the correct V/f pattern for the application and operation area. An incorrect V/f pattern can decrease motor torque and increase current from overexcitation. 	F (Determined by A1-02)	779
E1-04 (0303)	Maximum Output Frequency	<p>V/f CL-V/f OLV CLV AOLV OLV/PM AOLV/PM CLV/PM EZOLV</p> <p>Sets the maximum output frequency for the V/f pattern.</p>	Determined by A1-02 and E5-01 (Determined by A1-02 and E5-01)	784
E1-05 (0304)	Maximum Output Voltage	<p>V/f CL-V/f OLV CLV AOLV OLV/PM AOLV/PM CLV/PM EZOLV</p> <p>Sets the maximum output voltage for the V/f pattern.</p>	200.0 (200 V Class: 0.0 - 255.0 V, 400 V Class: 0.0 - 510.0 V)	784
E1-06 (0305)	Base Frequency	<p>V/f CL-V/f OLV CLV AOLV OLV/PM AOLV/PM CLV/PM EZOLV</p> <p>Sets the base frequency for the V/f pattern.</p>	Determined by A1-02 and E5-01 (0.0 - E1-04)	784
E1-07 (0306)	Mid Point A Frequency	<p>V/f CL-V/f OLV CLV AOLV OLV/PM AOLV/PM CLV/PM EZOLV</p> <p>Sets a middle output frequency for the V/f pattern.</p>	Determined by A1-02 (0.0 - E1-04)	784
E1-08 (0307)	Mid Point A Voltage	<p>V/f CL-V/f OLV CLV AOLV OLV/PM AOLV/PM CLV/PM EZOLV</p> <p>Sets a middle output voltage for the V/f pattern.</p>	Determined by A1-02, C6-01 and o2-04 (200 V Class: 0.0 - 255.0 V, 400 V Class: 0.0 - 510.0 V)	785
E1-09 (0308)	Minimum Output Frequency	<p>V/f CL-V/f OLV CLV AOLV OLV/PM AOLV/PM CLV/PM EZOLV</p> <p>Sets the minimum output frequency for the V/f pattern.</p>	Determined by A1-02 and E5-01 (Determined by A1-02, E1-04, and E5-01)	785
E1-10 (0309)	Minimum Output Voltage	<p>V/f CL-V/f OLV CLV AOLV OLV/PM AOLV/PM CLV/PM EZOLV</p> <p>Sets the minimum output voltage for the V/f pattern.</p>	Determined by A1-02 (200 V Class: 0.0 to 255.0 V, 400 V Class: 0.0 to 510.0 V)	785
E1-11 (030A) Expert	Mid Point B Frequency	<p>V/f CL-V/f OLV CLV AOLV OLV/PM AOLV/PM CLV/PM EZOLV</p> <p>Sets a middle output frequency for the V/f pattern.</p>	0.0 Hz (0.0 - E1-04)	785

11.8 E: Motor Parameters

No. (Hex.)	Name	Description	Default (Range)	Ref.
E1-12 (030B) Expert	Mid Point B Voltage	<input checked="" type="checkbox"/> V/f <input checked="" type="checkbox"/> CL-V/f <input checked="" type="checkbox"/> OLV <input checked="" type="checkbox"/> CLV <input checked="" type="checkbox"/> AOLV <input type="checkbox"/> OLV/PM <input type="checkbox"/> AOLV/PM <input type="checkbox"/> CLV/PM <input type="checkbox"/> EZOLV Sets a middle point voltage for the V/f pattern.	0.0 V (200 V Class: 0.0 to 255.0 V, 400 V Class: 0.0 to 510.0 V)	785
E1-13 (030C) Expert	Base Voltage	<input checked="" type="checkbox"/> V/f <input checked="" type="checkbox"/> CL-V/f <input checked="" type="checkbox"/> OLV <input checked="" type="checkbox"/> CLV <input checked="" type="checkbox"/> AOLV <input type="checkbox"/> OLV/PM <input type="checkbox"/> AOLV/PM <input type="checkbox"/> CLV/PM <input type="checkbox"/> EZOLV Sets the base voltage for the V/f pattern.	0.0 V (200 V Class: 0.0 - 255.0 V, 400 V Class: 0.0 - 510.0 V)	785

◆ E2: Motor Parameters

No. (Hex.)	Name	Description	Default (Range)	Ref.
E2-01 (030E)	Motor Rated Current (FLA)	<input checked="" type="checkbox"/> V/f <input checked="" type="checkbox"/> CL-V/f <input checked="" type="checkbox"/> OLV <input checked="" type="checkbox"/> CLV <input checked="" type="checkbox"/> AOLV <input type="checkbox"/> OLV/PM <input type="checkbox"/> AOLV/PM <input type="checkbox"/> CLV/PM <input type="checkbox"/> EZOLV Sets the motor rated current in amps.	Determined by o2-04, C6-01 (10% to 200% of the drive rated current)	786
E2-02 (030F)	Motor Rated Slip	<input checked="" type="checkbox"/> V/f <input checked="" type="checkbox"/> CL-V/f <input checked="" type="checkbox"/> OLV <input checked="" type="checkbox"/> CLV <input checked="" type="checkbox"/> AOLV <input type="checkbox"/> OLV/PM <input type="checkbox"/> AOLV/PM <input type="checkbox"/> CLV/PM <input type="checkbox"/> EZOLV Sets motor rated slip.	Determined by o2-04, C6-01 (0.000 - 20.000 Hz)	786
E2-03 (0310)	Motor No-Load Current	<input checked="" type="checkbox"/> V/f <input checked="" type="checkbox"/> CL-V/f <input checked="" type="checkbox"/> OLV <input checked="" type="checkbox"/> CLV <input checked="" type="checkbox"/> AOLV <input type="checkbox"/> OLV/PM <input type="checkbox"/> AOLV/PM <input type="checkbox"/> CLV/PM <input type="checkbox"/> EZOLV Sets the no-load current for the motor in amps when operating at the rated frequency and the no-load voltage.	Determined by o2-04, C6-01 (0 to E2-01)	786
E2-04 (0311)	Motor Pole Count	<input checked="" type="checkbox"/> V/f <input checked="" type="checkbox"/> CL-V/f <input checked="" type="checkbox"/> OLV <input checked="" type="checkbox"/> CLV <input checked="" type="checkbox"/> AOLV <input type="checkbox"/> OLV/PM <input type="checkbox"/> AOLV/PM <input type="checkbox"/> CLV/PM <input type="checkbox"/> EZOLV Sets the number of motor poles. Note: • When A1-02 = 0, 1, 3 [Control Method Selection = V/f, CL-V/f, CLV], the maximum value is 120. • When A1-02 = 2, 4 [OLV, AOLV], the maximum value is 48.	4 (2 - 120)	787
E2-05 (0312)	Motor Line-to-Line Resistance	<input checked="" type="checkbox"/> V/f <input checked="" type="checkbox"/> CL-V/f <input checked="" type="checkbox"/> OLV <input checked="" type="checkbox"/> CLV <input checked="" type="checkbox"/> AOLV <input type="checkbox"/> OLV/PM <input type="checkbox"/> AOLV/PM <input type="checkbox"/> CLV/PM <input type="checkbox"/> EZOLV Sets the line-to-line resistance for the motor stator windings. Note: On drive models 4810 to 4H12, the unit is mΩ, and the setting range is 0.000 mΩ to 65.000 mΩ.	Determined by o2-04, C6-01 (0.000 - 65.000 Ω)	787
E2-06 (0313)	Motor Leakage Inductance	<input checked="" type="checkbox"/> V/f <input checked="" type="checkbox"/> CL-V/f <input checked="" type="checkbox"/> OLV <input checked="" type="checkbox"/> CLV <input checked="" type="checkbox"/> AOLV <input type="checkbox"/> OLV/PM <input type="checkbox"/> AOLV/PM <input type="checkbox"/> CLV/PM <input type="checkbox"/> EZOLV Sets the voltage drop from motor leakage inductance when the motor is operating at the rated frequency and rated current. This value is a percentage of Motor Rated Voltage.	Determined by o2-04, C6-01 (0.0 - 60.0%)	787
E2-07 (0314)	Motor Saturation Coefficient 1	<input type="checkbox"/> V/f <input type="checkbox"/> CL-V/f <input checked="" type="checkbox"/> OLV <input checked="" type="checkbox"/> CLV <input checked="" type="checkbox"/> AOLV <input type="checkbox"/> OLV/PM <input type="checkbox"/> AOLV/PM <input type="checkbox"/> CLV/PM <input type="checkbox"/> EZOLV Sets the motor iron-core saturation coefficient at 50% of the magnetic flux.	0.50 (0.00 - 0.50)	787
E2-08 (0315)	Motor Saturation Coefficient 2	<input type="checkbox"/> V/f <input type="checkbox"/> CL-V/f <input checked="" type="checkbox"/> OLV <input checked="" type="checkbox"/> CLV <input checked="" type="checkbox"/> AOLV <input type="checkbox"/> OLV/PM <input type="checkbox"/> AOLV/PM <input type="checkbox"/> CLV/PM <input type="checkbox"/> EZOLV Sets the motor iron-core saturation coefficient at 75% of the magnetic flux.	0.75 (E2-07 - 0.75)	787
E2-09 (0316) Expert	Motor Mechanical Loss	<input type="checkbox"/> V/f <input type="checkbox"/> CL-V/f <input checked="" type="checkbox"/> OLV <input checked="" type="checkbox"/> CLV <input checked="" type="checkbox"/> AOLV <input type="checkbox"/> OLV/PM <input type="checkbox"/> AOLV/PM <input type="checkbox"/> CLV/PM <input type="checkbox"/> EZOLV Sets the mechanical loss of the motor. It is set as a percentage of E2-11 [Motor Rated Power]. Usually it is not necessary to change this setting.	0.0% (0.0 - 10.0%)	788
E2-10 (0317)	Motor Iron Loss	<input type="checkbox"/> V/f <input type="checkbox"/> CL-V/f <input checked="" type="checkbox"/> OLV <input checked="" type="checkbox"/> CLV <input checked="" type="checkbox"/> AOLV <input type="checkbox"/> OLV/PM <input type="checkbox"/> AOLV/PM <input type="checkbox"/> CLV/PM <input type="checkbox"/> EZOLV Sets the motor iron loss.	Determined by o2-04, C6-01 (0 - 65535 W)	788
E2-11 (0318)	Motor Rated Power	<input type="checkbox"/> V/f <input type="checkbox"/> CL-V/f <input checked="" type="checkbox"/> OLV <input checked="" type="checkbox"/> CLV <input checked="" type="checkbox"/> AOLV <input type="checkbox"/> OLV/PM <input type="checkbox"/> AOLV/PM <input type="checkbox"/> CLV/PM <input type="checkbox"/> EZOLV Sets the motor rated output in the units from o1-58 [Motor Power Unit Selection]. Note: On drive models 2xxx, and 4002 to 4675, the setting unit is 0.01 kW. The setting range is 0.00 kW to 650.00 kW (0.00 HP to 650.00 HP). On drive models 4810 to 4H12, the setting unit is 0.1 kW. The setting range is 0.0 kW to 1000.0 kW (0.0 HP to 1340.5 HP).	Determined by o2-04, C6-01 (0.00 - 1000.0)	788

◆ E3: V/f Pattern for Motor 2

No. (Hex.)	Name	Description	Default (Range)	Ref.
E3-01 (0319)	Motor 2 Control Mode Selection	<p>V/f CL-V/f OLV CLV AOLV OLV/PM AOLV/PM CLV/PM EZOLV</p> <p>Sets the control method for motor 2.</p> <p>Note: When you change this setting, the drive will set all parameters that are dependent on this parameter to their default settings.</p> <p>0 : V/f Control 1 : V/f Control with Encoder 2 : Open Loop Vector 3 : Closed Loop Vector</p>	0 (0 - 3)	789
E3-04 (031A)	Motor 2 Maximum Output Frequency	<p>V/f CL-V/f OLV CLV AOLV OLV/PM AOLV/PM CLV/PM EZOLV</p> <p>Sets the maximum output frequency for the motor 2 V/f pattern.</p>	Determined by E3-01 (40.0 - 590.0 Hz)	789
E3-05 (031B)	Motor 2 Maximum Output Voltage	<p>V/f CL-V/f OLV CLV AOLV OLV/PM AOLV/PM CLV/PM EZOLV</p> <p>Sets the maximum output voltage for the motor 2 V/f pattern.</p>	Determined by E3-01 (200 V Class: 0.0 - 255.0 V _V 400 V Class: 0.0 - 510.0 V)	789
E3-06 (031C)	Motor 2 Base Frequency	<p>V/f CL-V/f OLV CLV AOLV OLV/PM AOLV/PM CLV/PM EZOLV</p> <p>Sets the base frequency for the motor 2 V/f pattern.</p>	Determined by E3-01 (0.0 - E3-04)	789
E3-07 (031D)	Motor 2 Mid Point A Frequency	<p>V/f CL-V/f OLV CLV AOLV OLV/PM AOLV/PM CLV/PM EZOLV</p> <p>Sets a middle output frequency for the motor 2 V/f pattern.</p>	Determined by E3-01 (0.0 - E3-04)	789
E3-08 (031E)	Motor 2 Mid Point A Voltage	<p>V/f CL-V/f OLV CLV AOLV OLV/PM AOLV/PM CLV/PM EZOLV</p> <p>Sets a middle output voltage for the motor 2 V/f pattern.</p>	Determined by E3-01 (200 V Class: 0.0 - 255.0 V _V 400 V Class: 0.0 - 510.0 V)	789
E3-09 (031F)	Motor 2 Minimum Output Frequency	<p>V/f CL-V/f OLV CLV AOLV OLV/PM AOLV/PM CLV/PM EZOLV</p> <p>Sets the minimum output frequency for the motor 2 V/f pattern.</p>	Determined by E3-01 (0.0 - E3-04)	789
E3-10 (0320)	Motor 2 Minimum Output Voltage	<p>V/f CL-V/f OLV CLV AOLV OLV/PM AOLV/PM CLV/PM EZOLV</p> <p>Sets the minimum output voltage for the motor 2 V/f pattern.</p>	Determined by E3-01 (200 V Class: 0.0 - 255.0 V _V 400 V Class: 0.0 - 510.0 V)	790
E3-11 (0345) Expert	Motor 2 Mid Point B Frequency	<p>V/f CL-V/f OLV CLV AOLV OLV/PM AOLV/PM CLV/PM EZOLV</p> <p>Sets a middle output frequency for the motor 2 V/f pattern. Set this parameter to adjust the V/f pattern for the constant output range. Usually it is not necessary to change this parameter.</p>	0.0 Hz (0.0 - E3-04)	790
E3-12 (0346) Expert	Motor 2 Mid Point B Voltage	<p>V/f CL-V/f OLV CLV AOLV OLV/PM AOLV/PM CLV/PM EZOLV</p> <p>Sets a middle output voltage for the motor 2 V/f pattern. Set this parameter to adjust the V/f pattern for the constant output range. Usually it is not necessary to change this parameter.</p>	0.0 V (200 V Class: 0.0 to 255.0 V, 400 V Class: 0.0 to 510.0 V)	790
E3-13 (0347) Expert	Motor 2 Base Voltage	<p>V/f CL-V/f OLV CLV AOLV OLV/PM AOLV/PM CLV/PM EZOLV</p> <p>Sets the base voltage for the motor 2 V/f pattern. Set this parameter to adjust the V/f pattern for the constant output range. Usually it is not necessary to change this parameter.</p>	0.0 V (200 V Class: 0.0 to 255.0 V, 400 V Class: 0.0 to 510.0 V)	790

◆ E4: Motor 2 Parameters

No. (Hex.)	Name	Description	Default (Range)	Ref.
E4-01 (0321)	Motor 2 Rated Current	<p>V/f CL-V/f OLV CLV AOLV OLV/PM AOLV/PM CLV/PM EZOLV</p> <p>Sets the motor rated current for motor 2 in amps.</p>	Determined by o2-04, C6-01 (10% to 200% of the drive rated current)	790
E4-02 (0322)	Motor 2 Rated Slip	<p>V/f CL-V/f OLV CLV AOLV OLV/PM AOLV/PM CLV/PM EZOLV</p> <p>Sets the motor rated slip for motor 2.</p>	Determined by o2-04, C6-01 (0.000 - 20.000 Hz)	791
E4-03 (0323)	Motor 2 Rated No-Load Current	<p>V/f CL-V/f OLV CLV AOLV OLV/PM AOLV/PM CLV/PM EZOLV</p> <p>Sets the no-load current for motor 2 in amps when operating at the rated frequency and the no-load voltage.</p>	Determined by o2-04, C6-01 (Less than 0 - E4-01)	791
E4-04 (0324)	Motor 2 Motor Poles	<p>V/f CL-V/f OLV CLV AOLV OLV/PM AOLV/PM CLV/PM EZOLV</p> <p>Sets the number of poles for motor 2.</p>	4 (2 - 120)	791
E4-05 (0325)	Motor 2 Line-to-Line Resistance	<p>V/f CL-V/f OLV CLV AOLV OLV/PM AOLV/PM CLV/PM EZOLV</p> <p>Sets the line-to-line resistance for the motor 2 stator windings.</p> <p>Note: On drive models 4810 to 4H12, the unit is mΩ, and the setting range is 0.000 mΩ to 65.000 mΩ.</p>	Determined by o2-04, C6-01 (0.000 - 65.000 Ω)	791

11.8 E: Motor Parameters

No. (Hex.)	Name	Description	Default (Range)	Ref.
E4-06 (0326)	Motor 2 Leakage Inductance	<input type="checkbox"/> V/f <input type="checkbox"/> CL-V/f <input type="checkbox"/> OLV <input type="checkbox"/> CLV <input type="checkbox"/> AOLV <input type="checkbox"/> OLV/PM <input type="checkbox"/> AOLV/PM <input type="checkbox"/> CLV/PM <input type="checkbox"/> EZOLV Sets the voltage drop from motor 2 leakage inductance as a percentage of Motor Rated Voltage when motor 2 operates at the rated frequency and rated current.	Determined by o2-04, C6-01 (0.0 - 60.0%)	792
E4-07 (0343)	Motor 2 Saturation Coefficient 1	<input type="checkbox"/> V/f <input type="checkbox"/> CL-V/f <input type="checkbox"/> OLV <input type="checkbox"/> CLV <input type="checkbox"/> AOLV <input type="checkbox"/> OLV/PM <input type="checkbox"/> AOLV/PM <input type="checkbox"/> CLV/PM <input type="checkbox"/> EZOLV Sets the motor 2 iron-core saturation coefficient at 50% of the magnetic flux.	0.50 (0.00 - 0.50)	792
E4-08 (0344)	Motor 2 Saturation Coefficient 2	<input type="checkbox"/> V/f <input type="checkbox"/> CL-V/f <input type="checkbox"/> OLV <input type="checkbox"/> CLV <input type="checkbox"/> AOLV <input type="checkbox"/> OLV/PM <input type="checkbox"/> AOLV/PM <input type="checkbox"/> CLV/PM <input type="checkbox"/> EZOLV Sets the motor 2 iron-core saturation coefficient at 75% of the magnetic flux.	0.75 (E4-07 - 0.75)	792
E4-09 (033F) Expert	Motor 2 Mechanical Loss	<input type="checkbox"/> V/f <input type="checkbox"/> CL-V/f <input type="checkbox"/> OLV <input type="checkbox"/> CLV <input type="checkbox"/> AOLV <input type="checkbox"/> OLV/PM <input type="checkbox"/> AOLV/PM <input type="checkbox"/> CLV/PM <input type="checkbox"/> EZOLV Sets the mechanical loss of motor 2. It is set as a percentage of E4-11 [Motor 2 Rated Power]. Usually it is not necessary to change this setting.	0.0% (0.0 - 10.0%)	792
E4-10 (0340)	Motor 2 Iron Loss	<input type="checkbox"/> V/f <input type="checkbox"/> CL-V/f <input type="checkbox"/> OLV <input type="checkbox"/> CLV <input type="checkbox"/> AOLV <input type="checkbox"/> OLV/PM <input type="checkbox"/> AOLV/PM <input type="checkbox"/> CLV/PM <input type="checkbox"/> EZOLV Sets the motor iron loss for motor 2.	Determined by o2-04, C6-01 (0 - 65535 W)	792
E4-11 (0327)	Motor 2 Rated Power	<input type="checkbox"/> V/f <input type="checkbox"/> CL-V/f <input type="checkbox"/> OLV <input type="checkbox"/> CLV <input type="checkbox"/> AOLV <input type="checkbox"/> OLV/PM <input type="checkbox"/> AOLV/PM <input type="checkbox"/> CLV/PM <input type="checkbox"/> EZOLV Sets the motor rated output in the units from o1-58 [Motor Power Unit Selection]. Note: On drive models 2xxx, and 4002 to 4675, the setting unit is 0.01 kW. The setting range is 0.00 kW to 650.00 kW (0.00 HP to 650.00 HP). On drive models 4810 to 4H12, the setting unit is 0.1 kW. The setting range is 0.0 kW to 1000.0 kW (0.0 HP to 1340.5 HP).	Determined by o2-04, C6-01 (0.00 - 1000.0)	792

◆ E5: PM Motor Settings

No. (Hex.)	Name	Description	Default (Range)	Ref.
E5-01 (0329)	PM Motor Code Selection	<input type="checkbox"/> V/f <input type="checkbox"/> CL-V/f <input type="checkbox"/> OLV <input type="checkbox"/> CLV <input type="checkbox"/> AOLV <input checked="" type="checkbox"/> OLV/PM <input checked="" type="checkbox"/> AOLV/PM <input checked="" type="checkbox"/> CLV/PM <input type="checkbox"/> EZOLV Sets the motor code for Yaskawa PM motors. The drive uses the motor code to automatically set some parameters to their correct settings.	FFFF (0000 - FFFF)	793
E5-02 (032A)	PM Motor Rated Power	<input type="checkbox"/> V/f <input type="checkbox"/> CL-V/f <input type="checkbox"/> OLV <input type="checkbox"/> CLV <input type="checkbox"/> AOLV <input checked="" type="checkbox"/> OLV/PM <input checked="" type="checkbox"/> AOLV/PM <input checked="" type="checkbox"/> CLV/PM <input type="checkbox"/> EZOLV Sets the PM motor rated output in the units from o1-58 [Motor Power Unit Selection]. Note: On drive models 2xxx, and 4002 to 4675, the setting unit is 0.01 kW. The setting range is 0.10 kW to 650.00 kW (0.10 HP to 650.00 HP). On drive models 4810 to 4H12, the setting unit is 0.1 kW. The setting range is 0.1 kW to 1000.0 kW (0.1 HP to 1340.5 HP).	Determined by E5-01 (0.10 - 1000.0)	793
E5-03 (032B)	Motor Rated Current (FLA)	<input type="checkbox"/> V/f <input type="checkbox"/> CL-V/f <input type="checkbox"/> OLV <input type="checkbox"/> CLV <input type="checkbox"/> AOLV <input checked="" type="checkbox"/> OLV/PM <input checked="" type="checkbox"/> AOLV/PM <input checked="" type="checkbox"/> CLV/PM <input type="checkbox"/> EZOLV Sets the PM motor rated current (FLA).	Determined by E5-01 (10% to 200% of the drive rated current)	793
E5-04 (032C)	PM Motor Pole Count	<input type="checkbox"/> V/f <input type="checkbox"/> CL-V/f <input type="checkbox"/> OLV <input type="checkbox"/> CLV <input type="checkbox"/> AOLV <input checked="" type="checkbox"/> OLV/PM <input checked="" type="checkbox"/> AOLV/PM <input checked="" type="checkbox"/> CLV/PM <input type="checkbox"/> EZOLV Sets the number of PM motor poles. Note: • When A1-02 = 7 [Control Method Selection = CLV/PM], the maximum value is 120. • When A1-02 = 5, 6 or 8 [OLV/PM, AOLV/PM or EZOLV], the maximum value is 48.	Determined by E5-01 (2 - 120)	794
E5-05 (032D)	PM Motor Resistance (ohms/phase)	<input type="checkbox"/> V/f <input type="checkbox"/> CL-V/f <input type="checkbox"/> OLV <input type="checkbox"/> CLV <input type="checkbox"/> AOLV <input checked="" type="checkbox"/> OLV/PM <input checked="" type="checkbox"/> AOLV/PM <input checked="" type="checkbox"/> CLV/PM <input type="checkbox"/> EZOLV Sets the resistance per phase of a PM motor. Set 50% of the line-to-line resistance. Note: On drive models 4810 to 4H12, the unit is mΩ, and the setting range is 0.000 mΩ to 65.000 mΩ.	0.100 Ω (0.000 - 65.000 Ω)	794
E5-06 (032E)	PM d-axis Inductance (mH/phase)	<input type="checkbox"/> V/f <input type="checkbox"/> CL-V/f <input type="checkbox"/> OLV <input type="checkbox"/> CLV <input type="checkbox"/> AOLV <input checked="" type="checkbox"/> OLV/PM <input checked="" type="checkbox"/> AOLV/PM <input checked="" type="checkbox"/> CLV/PM <input type="checkbox"/> EZOLV Sets the PM motor d-axis inductance.	1.00 mH (0.00 - 300.00 mH)	794
E5-07 (032F)	PM q-axis Inductance (mH/phase)	<input type="checkbox"/> V/f <input type="checkbox"/> CL-V/f <input type="checkbox"/> OLV <input type="checkbox"/> CLV <input type="checkbox"/> AOLV <input checked="" type="checkbox"/> OLV/PM <input checked="" type="checkbox"/> AOLV/PM <input checked="" type="checkbox"/> CLV/PM <input type="checkbox"/> EZOLV Sets the PM motor q-axis inductance.	1.00 mH (0.00 - 600.00 mH)	794
E5-09 (0331)	PM Back-EMF Vpeak (mV/(rad/s))	<input type="checkbox"/> V/f <input type="checkbox"/> CL-V/f <input type="checkbox"/> OLV <input type="checkbox"/> CLV <input type="checkbox"/> AOLV <input checked="" type="checkbox"/> OLV/PM <input checked="" type="checkbox"/> AOLV/PM <input checked="" type="checkbox"/> CLV/PM <input type="checkbox"/> EZOLV Sets the peak value of PM motor induced voltage.	0.0 mV/(rad/sec) (0.0 - 2000.0 mV/(rad/s))	794
E5-11 (0333)	Encoder Z-Pulse Offset	<input type="checkbox"/> V/f <input type="checkbox"/> CL-V/f <input type="checkbox"/> OLV <input type="checkbox"/> CLV <input type="checkbox"/> AOLV <input type="checkbox"/> OLV/PM <input type="checkbox"/> AOLV/PM <input checked="" type="checkbox"/> CLV/PM <input type="checkbox"/> EZOLV Sets the encoder Z-pulse offset.	0.0 degrees (-180.0 - +180.0 degrees)	795

No. (Hex.)	Name	Description	Default (Range)	Ref.
E5-24 (0353)	PM Back-EMF L-L Vrms (mV/rpm)	<input type="checkbox"/> V/f <input type="checkbox"/> CL-V/f <input type="checkbox"/> OLV <input type="checkbox"/> CLV <input type="checkbox"/> AOLV <input checked="" type="checkbox"/> OLV/PM <input type="checkbox"/> AOLV/PM <input type="checkbox"/> CLV/PM <input type="checkbox"/> EZOLV Sets the RMS value for PM motor line voltage.	200 V Class: 100.0 mV/min ⁻¹ 400 V Class: 200.0 mV/min ⁻¹ (0.0 - 6500.0 mV/min ⁻¹)	795
E5-25 (035E) Expert	Polarity Estimation Timeout	<input type="checkbox"/> V/f <input type="checkbox"/> CL-V/f <input type="checkbox"/> OLV <input type="checkbox"/> CLV <input type="checkbox"/> AOLV <input checked="" type="checkbox"/> OLV/PM <input type="checkbox"/> AOLV/PM <input type="checkbox"/> CLV/PM <input type="checkbox"/> EZOLV Sets the function that switches polarity for initial polarity estimation. Usually it is not necessary to change this setting. 0 : Disabled 1 : Enabled	0 (0, 1)	795

◆ E9: Motor Setting

No. (Hex.)	Name	Description	Default (Range)	Ref.
E9-01 (11E4)	Motor Type Selection	<input type="checkbox"/> V/f <input type="checkbox"/> CL-V/f <input type="checkbox"/> OLV <input type="checkbox"/> CLV <input type="checkbox"/> AOLV <input type="checkbox"/> OLV/PM <input type="checkbox"/> AOLV/PM <input type="checkbox"/> CLV/PM <input checked="" type="checkbox"/> EZOLV Sets the type of motor. 0 : Induction (IM) 1 : Permanent Magnet (PM) 2 : Synchronous Reluctance (SynRM)	0 (0 - 2)	795
E9-02 (11E5)	Maximum Speed	<input type="checkbox"/> V/f <input type="checkbox"/> CL-V/f <input type="checkbox"/> OLV <input type="checkbox"/> CLV <input type="checkbox"/> AOLV <input type="checkbox"/> OLV/PM <input type="checkbox"/> AOLV/PM <input type="checkbox"/> CLV/PM <input checked="" type="checkbox"/> EZOLV Sets the maximum speed of the motor.	Determined by E9-01 (40.0 - 120.0 Hz)	796
E9-03 (11E6)	Rated Speed	<input type="checkbox"/> V/f <input type="checkbox"/> CL-V/f <input type="checkbox"/> OLV <input type="checkbox"/> CLV <input type="checkbox"/> AOLV <input type="checkbox"/> OLV/PM <input type="checkbox"/> AOLV/PM <input type="checkbox"/> CLV/PM <input checked="" type="checkbox"/> EZOLV Sets the rated rotation speed of the motor.	Determined by E9-01 (100 - 7200 min ⁻¹)	796
E9-04 (11E7)	Base Frequency	<input type="checkbox"/> V/f <input type="checkbox"/> CL-V/f <input type="checkbox"/> OLV <input type="checkbox"/> CLV <input type="checkbox"/> AOLV <input type="checkbox"/> OLV/PM <input type="checkbox"/> AOLV/PM <input type="checkbox"/> CLV/PM <input checked="" type="checkbox"/> EZOLV Sets the rated frequency of the motor.	Determined by E9-01 (40.0 - 120.0 Hz)	796
E9-05 (11E8)	Motor Rated Voltage	<input type="checkbox"/> V/f <input type="checkbox"/> CL-V/f <input type="checkbox"/> OLV <input type="checkbox"/> CLV <input type="checkbox"/> AOLV <input type="checkbox"/> OLV/PM <input type="checkbox"/> AOLV/PM <input type="checkbox"/> CLV/PM <input checked="" type="checkbox"/> EZOLV Sets the rated voltage of the motor.	200 V Class: 200.0 V, 400 V Class: 400.0 V (200 V Class: 0.0 - 255.0 V, 400 V Class: 0.0 - 510.0 V)	796
E9-06 (11E9)	Motor Rated Current (FLA)	<input type="checkbox"/> V/f <input type="checkbox"/> CL-V/f <input type="checkbox"/> OLV <input type="checkbox"/> CLV <input type="checkbox"/> AOLV <input type="checkbox"/> OLV/PM <input type="checkbox"/> AOLV/PM <input type="checkbox"/> CLV/PM <input checked="" type="checkbox"/> EZOLV Sets the motor rated current in amps.	Determined by E9-01 and o2-04 (10% to 200% of the drive rated current)	796
E9-07 (11EA)	PM Motor Rated Power	<input type="checkbox"/> V/f <input type="checkbox"/> CL-V/f <input type="checkbox"/> OLV <input type="checkbox"/> CLV <input type="checkbox"/> AOLV <input type="checkbox"/> OLV/PM <input type="checkbox"/> AOLV/PM <input type="checkbox"/> CLV/PM <input checked="" type="checkbox"/> EZOLV Sets the motor rated output in the units from o1-58 [Motor Power Unit Selection]. Note: On drive models 2xxx, and 4002 to 4675, the setting unit is 0.01 kW. The setting range is 0.00 kW to 650.00 kW (0.00 HP to 650.00 HP). On drive models 4810 to 4H12, the setting unit is 0.1 kW. The setting range is 0.0 kW to 1000.0 kW (0.0 HP to 1340.5 HP).	Determined by E9-02 and o2-04 (0.00 - 1000.0)	796
E9-08 (11EB)	Motor Pole Count	<input type="checkbox"/> V/f <input type="checkbox"/> CL-V/f <input type="checkbox"/> OLV <input type="checkbox"/> CLV <input type="checkbox"/> AOLV <input type="checkbox"/> OLV/PM <input type="checkbox"/> AOLV/PM <input type="checkbox"/> CLV/PM <input checked="" type="checkbox"/> EZOLV Sets the number of motor poles.	4 (2 to 120)	797
E9-09 (11EC)	Motor Rated Slip	<input type="checkbox"/> V/f <input type="checkbox"/> CL-V/f <input type="checkbox"/> OLV <input type="checkbox"/> CLV <input type="checkbox"/> AOLV <input type="checkbox"/> OLV/PM <input type="checkbox"/> AOLV/PM <input type="checkbox"/> CLV/PM <input checked="" type="checkbox"/> EZOLV Sets the motor rated slip.	0.000 Hz (0.000 - 20.000 Hz)	797
E9-10 (11ED)	Motor Line-to-Line Resistance	<input type="checkbox"/> V/f <input type="checkbox"/> CL-V/f <input type="checkbox"/> OLV <input type="checkbox"/> CLV <input type="checkbox"/> AOLV <input type="checkbox"/> OLV/PM <input type="checkbox"/> AOLV/PM <input type="checkbox"/> CLV/PM <input checked="" type="checkbox"/> EZOLV Sets the line-to-line resistance for the motor stator windings. Note: On drive models 4810 to 4H12, the unit is mΩ, and the setting range is 0.000 mΩ to 65.000 mΩ.	Determined by o2-04 (0.000 - 65.000 Ω)	797

11.9 F: Options

◆ F1: PG Option Setup (Encoder)

No. (Hex.)	Name	Description	Default (Range)	Ref.
F1-01 (0380)	Encoder 1 Pulse Count (PPR)	<input type="checkbox"/> V/f <input type="checkbox"/> CL-V/f <input type="checkbox"/> OLV <input type="checkbox"/> CLV <input type="checkbox"/> AOLV <input type="checkbox"/> OLV/PM <input type="checkbox"/> AOLV/PM <input type="checkbox"/> CLV/PM <input type="checkbox"/> EZOLV Sets the number of output pulses for each motor revolution.	1024 ppr (1 - 60000 ppr)	799
F1-02 (0381)	Encoder Signal Loss Detect Sel	<input type="checkbox"/> V/f <input type="checkbox"/> CL-V/f <input type="checkbox"/> OLV <input type="checkbox"/> CLV <input type="checkbox"/> AOLV <input type="checkbox"/> OLV/PM <input type="checkbox"/> AOLV/PM <input type="checkbox"/> CLV/PM <input type="checkbox"/> EZOLV Sets the method to stop the motor or let the motor continue operating when the drive detects <i>PGo</i> [Encoder (PG) Feedback Loss]. 0 : Ramp to Stop 1 : Coast to Stop 2 : Fast Stop (Use C1-09) 3 : Alarm Only 4 : No Alarm Display	1 (0 - 4)	799
F1-03 (0382)	Overspeed Detection Selection	<input type="checkbox"/> V/f <input type="checkbox"/> CL-V/f <input type="checkbox"/> OLV <input type="checkbox"/> CLV <input type="checkbox"/> AOLV <input type="checkbox"/> OLV/PM <input type="checkbox"/> AOLV/PM <input type="checkbox"/> CLV/PM <input type="checkbox"/> EZOLV Sets the method to stop the motor or let the motor continue operating when the drive detects <i>oS</i> [Overspeed]. 0 : Ramp to Stop 1 : Coast to Stop 2 : Fast Stop (Use C1-09) 3 : Alarm Only	1 (0 - 3)	799
F1-04 (0383)	Speed Deviation Detection Select	<input type="checkbox"/> V/f <input type="checkbox"/> CL-V/f <input type="checkbox"/> OLV <input type="checkbox"/> CLV <input type="checkbox"/> AOLV <input type="checkbox"/> OLV/PM <input type="checkbox"/> AOLV/PM <input type="checkbox"/> CLV/PM <input type="checkbox"/> EZOLV Sets the method to stop the motor or let the motor continue operating when the drive detects <i>dEv</i> [Speed Deviation]. 0 : Ramp to Stop 1 : Coast to Stop 2 : Fast Stop (Use C1-09) 3 : Alarm Only	3 (0 - 3)	800
F1-05 (0384)	Encoder 1 Rotation Selection	<input type="checkbox"/> V/f <input type="checkbox"/> CL-V/f <input type="checkbox"/> OLV <input type="checkbox"/> CLV <input type="checkbox"/> AOLV <input type="checkbox"/> OLV/PM <input type="checkbox"/> AOLV/PM <input type="checkbox"/> CLV/PM <input type="checkbox"/> EZOLV Sets the output sequence for the A and B pulses from the encoder, assuming that the motor is operating in the forward direction. 0 : Pulse A leads in FWD Direction 1 : Pulse B leads in FWD Direction	Determined by A1-02 (0, 1)	800
F1-06 (0385)	Encoder 1 Pulse Monitor Scaling	<input type="checkbox"/> V/f <input type="checkbox"/> CL-V/f <input type="checkbox"/> OLV <input type="checkbox"/> CLV <input type="checkbox"/> AOLV <input type="checkbox"/> OLV/PM <input type="checkbox"/> AOLV/PM <input type="checkbox"/> CLV/PM <input type="checkbox"/> EZOLV Sets the ratio between the pulse input and the pulse output of the encoder as a 3-digit number. The first digit is the numerator and the second and third digits set the denominator. The dividing ratio = (1 + x)/yz when the setting value is a 3-digit value (xyz).	001 (001 - 032, 102 - 132 (1 - 1/32))	800
F1-08 (0387)	Overspeed Detection Level	<input type="checkbox"/> V/f <input type="checkbox"/> CL-V/f <input type="checkbox"/> OLV <input type="checkbox"/> CLV <input type="checkbox"/> AOLV <input type="checkbox"/> OLV/PM <input type="checkbox"/> AOLV/PM <input type="checkbox"/> CLV/PM <input type="checkbox"/> EZOLV Sets the detection level of <i>oS</i> [Overspeed] as a percentage when the maximum output frequency is 100%. Note: • Parameter A1-02 [Control Method Selection] selects which parameter is the maximum output frequency. –A1-02 ≠ 8 [EZOLV]: E1-04 [Maximum Output Frequency] –A1-02 = 8: E9-02 [Maximum Speed] • If A1-02 = 0 [Control Method Selection = V/f], you must set H6-01 = 3 [Terminal RP Pulse Train Function = Speed Feedback (V/F Control)] to enable this parameter.	115% (0 - 120%)	801
F1-09 (0388)	Overspeed Detection Delay Time	<input type="checkbox"/> V/f <input type="checkbox"/> CL-V/f <input type="checkbox"/> OLV <input type="checkbox"/> CLV <input type="checkbox"/> AOLV <input type="checkbox"/> OLV/PM <input type="checkbox"/> AOLV/PM <input type="checkbox"/> CLV/PM <input type="checkbox"/> EZOLV Sets the length of time that the speed feedback must be more than the F1-08 level to cause <i>oS</i> [Overspeed]. Note: If A1-02 = 0 [Control Method Selection = V/f], you must set H6-01 = 3 [Terminal RP Pulse Train Function = Speed Feedback (V/F Control)] to enable this parameter.	Determined by A1-02 (0.0 - 2.0 s)	801
F1-10 (0389)	Speed Deviation Detection Level	<input type="checkbox"/> V/f <input type="checkbox"/> CL-V/f <input type="checkbox"/> OLV <input type="checkbox"/> CLV <input type="checkbox"/> AOLV <input type="checkbox"/> OLV/PM <input type="checkbox"/> AOLV/PM <input type="checkbox"/> CLV/PM <input type="checkbox"/> EZOLV Sets the detection level of <i>dEv</i> [Speed Deviation] as a percentage when the maximum output frequency is 100%. Note: • Parameter A1-02 [Control Method Selection] selects which parameter is the maximum output frequency. –A1-02 ≠ 8 [EZOLV]: E1-04 [Maximum Output Frequency] –A1-02 = 8: E9-02 [Maximum Speed] • If A1-02 = 0 [Control Method Selection = V/f], you must set H6-01 = 3 [Terminal RP Pulse Train Function = Speed Feedback (V/F Control)] to enable this parameter.	10% (0 - 50%)	801

No. (Hex.)	Name	Description	Default (Range)	Ref.
F1-11 (038A)	Speed Deviation Detect DelayTime	<input type="checkbox"/> V/f <input checked="" type="checkbox"/> CL-V/f <input type="checkbox"/> OLV <input type="checkbox"/> CLV <input type="checkbox"/> AOLV <input type="checkbox"/> OLV/PM <input type="checkbox"/> AOLV/PM <input type="checkbox"/> CLV/PM <input type="checkbox"/> EZOLV Sets the length of time that the difference between the frequency reference and speed feedback must be more than the level in F1-10 to cause dEv [Speed Deviation]. Note: If A1-02 = 0 [Control Method Selection = V/f], you must set H6-01 = 3 [Terminal RP Pulse Train Function = Speed Feedback (V/F Control)] to enable this parameter.	0.5 s (0.0 - 10.0 s)	801
F1-12 (038B)	Encoder 1 Gear Teeth 1	<input type="checkbox"/> V/f <input checked="" type="checkbox"/> CL-V/f <input type="checkbox"/> OLV <input type="checkbox"/> CLV <input type="checkbox"/> AOLV <input type="checkbox"/> OLV/PM <input type="checkbox"/> AOLV/PM <input type="checkbox"/> CLV/PM <input type="checkbox"/> EZOLV Sets the number of gear teeth on the motor side. This parameter and F1-13 [Encoder 1 Gear Teeth 2] set the gear ratio between the motor and encoder.	0 (0 - 1000)	801
F1-13 (038C)	Encoder 2 Gear Teeth 1	<input type="checkbox"/> V/f <input checked="" type="checkbox"/> CL-V/f <input type="checkbox"/> OLV <input type="checkbox"/> CLV <input type="checkbox"/> AOLV <input type="checkbox"/> OLV/PM <input type="checkbox"/> AOLV/PM <input type="checkbox"/> CLV/PM <input type="checkbox"/> EZOLV Sets the number of gear teeth on the load side. This parameter and F1-12 [Encoder 1 Gear Teeth 1] set the gear ratio between the motor and encoder.	0 (0 - 1000)	801
F1-14 (038D)	Encoder Open-Circuit Detect Time	<input type="checkbox"/> V/f <input checked="" type="checkbox"/> CL-V/f <input type="checkbox"/> OLV <input type="checkbox"/> CLV <input type="checkbox"/> AOLV <input type="checkbox"/> OLV/PM <input type="checkbox"/> AOLV/PM <input type="checkbox"/> CLV/PM <input type="checkbox"/> EZOLV Sets the length of time that the drive must not receive a pulse signal to cause PGo [Encoder (PG) Feedback Loss]. Note: Motor speed and load conditions can cause ov [Overvoltage] and oC [Overcurrent] faults. If A1-02 = 0 [Control Method Selection = V/f], you must set H6-01 = 3 [Terminal RP Pulse Train Function = Speed Feedback (V/F Control)] to enable this parameter.	2.0 s (0.0 - 10.0 s)	802
F1-16 (03AB) Expert	Deviation 1 Detection Selection	<input type="checkbox"/> V/f <input checked="" type="checkbox"/> CL-V/f <input type="checkbox"/> OLV <input checked="" type="checkbox"/> CLV <input type="checkbox"/> AOLV <input type="checkbox"/> OLV/PM <input type="checkbox"/> AOLV/PM <input type="checkbox"/> CLV/PM <input type="checkbox"/> EZOLV Sets the function that enables and disables Deviation 1 Detection Selection. When A1-02 = 7 [Control Method Selection = CLV/PM], this function is always enabled. 0 : Disabled 1 : Enabled	0 (0, 1)	802
F1-17 (03AC)	Deviation 2 Detection Selection	<input type="checkbox"/> V/f <input checked="" type="checkbox"/> CL-V/f <input type="checkbox"/> OLV <input type="checkbox"/> CLV <input type="checkbox"/> AOLV <input type="checkbox"/> OLV/PM <input type="checkbox"/> AOLV/PM <input checked="" type="checkbox"/> CLV/PM <input type="checkbox"/> EZOLV Usually it is not necessary to change this setting. Sets the number of motor rotations that the drive will detect more than one Z pulse per rotation to detect dv2.	10 (0 - 100)	802
F1-18 (03AD)	Deviation 3 Detection Selection	<input type="checkbox"/> V/f <input checked="" type="checkbox"/> CL-V/f <input type="checkbox"/> OLV <input type="checkbox"/> CLV <input type="checkbox"/> AOLV <input type="checkbox"/> OLV/PM <input type="checkbox"/> AOLV/PM <input checked="" type="checkbox"/> CLV/PM <input type="checkbox"/> EZOLV Sets the number of rotations necessary to detect conditions that invert the torque reference and rate of acceleration and cause dv3 [Inversion Detection].	10 (0 - 10)	802
F1-19 (03AE)	Deviation 4 Detection Selection	<input type="checkbox"/> V/f <input checked="" type="checkbox"/> CL-V/f <input type="checkbox"/> OLV <input type="checkbox"/> CLV <input type="checkbox"/> AOLV <input type="checkbox"/> OLV/PM <input type="checkbox"/> AOLV/PM <input checked="" type="checkbox"/> CLV/PM <input type="checkbox"/> EZOLV Sets the number of pulses necessary to cause dv4 [Inversion Prevention Detection].	128 (0 - 5000)	802
F1-20 (03B4)	Encoder 1 PCB Disconnect Detect	<input type="checkbox"/> V/f <input checked="" type="checkbox"/> CL-V/f <input type="checkbox"/> OLV <input type="checkbox"/> CLV <input type="checkbox"/> AOLV <input type="checkbox"/> OLV/PM <input type="checkbox"/> AOLV/PM <input checked="" type="checkbox"/> CLV/PM <input type="checkbox"/> EZOLV Sets the function that enables and disables detection of a disconnected encoder connection cable to cause PGoH [Encoder (PG) Hardware Fault]. 0 : Disabled 1 : Enabled	1 (0, 1)	803
F1-21 (03BC)	Encoder 1 Signal Selection	<input type="checkbox"/> V/f <input checked="" type="checkbox"/> CL-V/f <input type="checkbox"/> OLV <input type="checkbox"/> CLV <input type="checkbox"/> AOLV <input type="checkbox"/> OLV/PM <input type="checkbox"/> AOLV/PM <input type="checkbox"/> CLV/PM <input type="checkbox"/> EZOLV Sets the number of channels for the signal to the encoder option card. 0 : A Pulse Detection 1 : AB Pulse Detection	0 (0, 1)	803
F1-30 (03AA)	Motor 2 Encoder PCB Port Select	<input type="checkbox"/> V/f <input checked="" type="checkbox"/> CL-V/f <input type="checkbox"/> OLV <input type="checkbox"/> CLV <input type="checkbox"/> AOLV <input type="checkbox"/> OLV/PM <input type="checkbox"/> AOLV/PM <input type="checkbox"/> CLV/PM <input type="checkbox"/> EZOLV Sets the drive port to install the motor 2 encoder option card. 0 : CN5-C 1 : CN5-B	1 (0, 1)	803
F1-31 (03B0)	Encoder 2 Pulse Count (PPR)	<input type="checkbox"/> V/f <input checked="" type="checkbox"/> CL-V/f <input type="checkbox"/> OLV <input type="checkbox"/> CLV <input type="checkbox"/> AOLV <input type="checkbox"/> OLV/PM <input type="checkbox"/> AOLV/PM <input type="checkbox"/> CLV/PM <input type="checkbox"/> EZOLV Sets the number of output pulses for each motor revolution for motor 2. Note: When A1-02 = 3, 7 [Control Method Selection = CLV, CLV/PM], you can set the number of output pulses without setting H1-xx = 16 [Motor 2 Selection].	1024 ppr (1 - 60000 ppr)	803
F1-32 (03B1)	Encoder 2 Rotation Selection	<input type="checkbox"/> V/f <input checked="" type="checkbox"/> CL-V/f <input type="checkbox"/> OLV <input type="checkbox"/> CLV <input type="checkbox"/> AOLV <input type="checkbox"/> OLV/PM <input type="checkbox"/> AOLV/PM <input type="checkbox"/> CLV/PM <input type="checkbox"/> EZOLV Sets the output sequence for the A and B pulses from the encoder for motor 2. This parameter assumes that the motor is operating in the forward direction. Note: When A1-02 = 3, 7 [Control Method Selection = CLV, CLV/PM], you can set this parameter without setting H1-xx = 16 [Motor 2 Selection]. 0 : Pulse A leads in FWD Direction 1 : Pulse B leads in FWD Direction	0 (0, 1)	803
F1-33 (03B2)	Encoder 2 Gear Teeth 1	<input type="checkbox"/> V/f <input checked="" type="checkbox"/> CL-V/f <input type="checkbox"/> OLV <input type="checkbox"/> CLV <input type="checkbox"/> AOLV <input type="checkbox"/> OLV/PM <input type="checkbox"/> AOLV/PM <input type="checkbox"/> CLV/PM <input type="checkbox"/> EZOLV Sets the number of gear teeth on the motor side for motor 2. This parameter and F1-34 [Encoder 2 Gear Teeth 2] set the gear ratio between the motor and encoder.	0 (0 - 1000)	804
F1-34 (03B3)	Encoder 2 Gear Teeth 2	<input type="checkbox"/> V/f <input checked="" type="checkbox"/> CL-V/f <input type="checkbox"/> OLV <input type="checkbox"/> CLV <input type="checkbox"/> AOLV <input type="checkbox"/> OLV/PM <input type="checkbox"/> AOLV/PM <input type="checkbox"/> CLV/PM <input type="checkbox"/> EZOLV Sets the number of gear teeth on the load side for motor 2. This parameter and F1-33 [Encoder 2 Gear Teeth 1] set the gear ratio between the motor and encoder.	0 (0 - 1000)	804

11.9 F: Options

No. (Hex.)	Name	Description	Default (Range)	Ref.
F1-35 (03BE)	Encoder 2 Pulse Monitor Scaling	<p>V/f <input type="checkbox"/> CL-V/f <input checked="" type="checkbox"/> OLV <input type="checkbox"/> CLV <input checked="" type="checkbox"/> AOLV <input type="checkbox"/> OLV/PM <input type="checkbox"/> AOLV/PM <input type="checkbox"/> CLV/PM <input type="checkbox"/> EZOLV <input type="checkbox"/></p> <p>Sets the ratio between the pulse input and the pulse output of the encoder as a 3-digit number for motor 2. The first digit is the numerator and the second and third digits are the denominator.</p> <p>The dividing ratio = $(1 + x)/yz$ when the setting value is a 3-digit value (xyz).</p> <p>Note: When $A1-02 = 3, 7$ [Control Method Selection = CLV, CLV/PM], you can set this parameter without setting $H1-xx = 16$ [Motor 2 Selection].</p>	001 (001 - 032, 102 - 132 (1 - 1/32))	804
F1-36 (03B5)	Encoder 2 PCB Disconnect Detect	<p>V/f <input type="checkbox"/> CL-V/f <input checked="" type="checkbox"/> OLV <input type="checkbox"/> CLV <input checked="" type="checkbox"/> AOLV <input type="checkbox"/> OLV/PM <input type="checkbox"/> AOLV/PM <input type="checkbox"/> CLV/PM <input type="checkbox"/> EZOLV <input type="checkbox"/></p> <p>Sets the function that enables and disables detection of a disconnected encoder connection cable that causes <i>PGoH [Encoder (PG) Hardware Fault]</i> for motor 2.</p> <p>Note: When $A1-02 = 3, 7$ [Control Method Selection = CLV, CLV/PM], you can set this parameter without setting $H1-xx = 16$ [Motor 2 Selection].</p> <p>0 : Disabled 1 : Enabled</p>	1 (0, 1)	804
F1-37 (03BD)	Encoder 2 Signal Selection	<p>V/f <input type="checkbox"/> CL-V/f <input checked="" type="checkbox"/> OLV <input type="checkbox"/> CLV <input checked="" type="checkbox"/> AOLV <input type="checkbox"/> OLV/PM <input type="checkbox"/> AOLV/PM <input type="checkbox"/> CLV/PM <input type="checkbox"/> EZOLV <input type="checkbox"/></p> <p>Sets the number of channels for the signal to the encoder option for motor 2.</p> <p>Note: When $A1-02 = 3, 7$ [Control Method Selection = CLV, CLV/PM], you can set this parameter without setting $H1-xx = 16$ [Motor 2 Selection].</p> <p>0 : A Pulse Detection 1 : AB Pulse Detection</p>	0 (0, 1)	804
F1-46 (1B98)	dv2 Detection Method Selection	<p>V/f <input type="checkbox"/> CL-V/f <input checked="" type="checkbox"/> OLV <input type="checkbox"/> CLV <input checked="" type="checkbox"/> AOLV <input type="checkbox"/> OLV/PM <input type="checkbox"/> AOLV/PM <input checked="" type="checkbox"/> CLV/PM <input type="checkbox"/> EZOLV <input type="checkbox"/></p> <p>Usually it is not necessary to change this setting. Sets the detection method for <i>dv2 [Z Pulse Noise Fault Detection]</i>.</p> <p>0 : ElectricalAngle Detection Method 1 : MechanicalAngle Detection Method</p>	0 (0, 1)	805
F1-47 (1B99)	Deviation 2 Detection Selection	<p>V/f <input type="checkbox"/> CL-V/f <input checked="" type="checkbox"/> OLV <input type="checkbox"/> CLV <input checked="" type="checkbox"/> AOLV <input type="checkbox"/> OLV/PM <input type="checkbox"/> AOLV/PM <input checked="" type="checkbox"/> CLV/PM <input type="checkbox"/> EZOLV <input type="checkbox"/></p> <p>Usually it is not necessary to change this setting. Sets the sensitivity of detection for <i>dv2 [Z Pulse Noise Fault Detection]</i>. Increase the value to decrease the sensitivity.</p>	15° (0 - 180°)	805
F1-50 (03D2)	PG-F3 Option Encoder Type	<p>V/f <input type="checkbox"/> CL-V/f <input checked="" type="checkbox"/> OLV <input type="checkbox"/> CLV <input checked="" type="checkbox"/> AOLV <input type="checkbox"/> OLV/PM <input type="checkbox"/> AOLV/PM <input checked="" type="checkbox"/> CLV/PM <input type="checkbox"/> EZOLV <input type="checkbox"/></p> <p>Sets the type of encoder connected to the PG-F3 option.</p> <p>0 : EnDat Sin/Cos 1 : EnDat Serial Only 2 : HIPERFACE</p>	0 (0 - 2)	805
F1-51 (03D3)	PG-F3 PGoH Detection Level	<p>V/f <input type="checkbox"/> CL-V/f <input checked="" type="checkbox"/> OLV <input type="checkbox"/> CLV <input checked="" type="checkbox"/> AOLV <input type="checkbox"/> OLV/PM <input type="checkbox"/> AOLV/PM <input checked="" type="checkbox"/> CLV/PM <input type="checkbox"/> EZOLV <input type="checkbox"/></p> <p>The drive will detect <i>PGoH [Encoder (PG) Hardware Fault]</i> if the value of this parameter is smaller than the value of $\sqrt{\sin^2\theta + \cos^2\theta}$.</p> <p>Note: This function is enabled when $F1-20 = 1$ [Encoder 1 PCB Disconnect Detect = Enabled].</p>	80% (1 - 100%)	805
F1-52 (03D4)	Serial Encoder Comm Speed	<p>V/f <input type="checkbox"/> CL-V/f <input checked="" type="checkbox"/> OLV <input type="checkbox"/> CLV <input checked="" type="checkbox"/> AOLV <input type="checkbox"/> OLV/PM <input type="checkbox"/> AOLV/PM <input checked="" type="checkbox"/> CLV/PM <input type="checkbox"/> EZOLV <input type="checkbox"/></p> <p>Sets the communication speed between the PG-F3 option and the serial encoder.</p> <p>0 : 1M/9600bps 1 : 500k/19200bps 2 : 1M/38400bps</p>	0 (0 - 2)	805

◆ F2: Analog Input Option

No. (Hex.)	Name	Description	Default (Range)	Ref.
F2-01 (038F)	Analog Input Function Selection	<p>V/f CL-V/f OLV CLV AOLV OLV/PM AOLV/PM CLV/PM EZOLV</p> <p>Sets the input method for the analog reference used with A1-A3. 0 : 3 Independent Channels 1 : 3 Channels Added Together</p>	0 (0, 1)	806
F2-02 (0368) RUN	Analog Input Option Card Gain	<p>V/f CL-V/f OLV CLV AOLV OLV/PM AOLV/PM CLV/PM EZOLV</p> <p>Sets the analog reference gain as a percentage when the maximum output frequency is 100%.</p> <p>Note:</p> <ul style="list-style-type: none"> Set F2-01 = 1 [Analog Input Function Selection = 3 Channels Added Together] to enable this function. Parameter A1-02 [Control Method Selection] selects which parameter is the maximum output frequency. -A1-02 ≠ 8 [EZOLV]: E1-04 [Maximum Output Frequency] -A1-02 = 8: E9-02 [Maximum Speed] 	100.0% (-999.9 - +999.9%)	807
F2-03 (0369) RUN	Analog Input Option Card Bias	<p>V/f CL-V/f OLV CLV AOLV OLV/PM AOLV/PM CLV/PM EZOLV</p> <p>Sets the analog reference bias as a percentage when the maximum output frequency is 100%.</p> <p>Note:</p> <ul style="list-style-type: none"> Set F2-01 = 1 [Analog Input Function Selection = 3 Channels Added Together] to enable this function. Parameter A1-02 [Control Method Selection] selects which parameter is the maximum output frequency. -A1-02 ≠ 8 [EZOLV]: E1-04 [Maximum Output Frequency] -A1-02 = 8: E9-02 [Maximum Speed] 	0.0% (-999.9 - +999.9%)	807

◆ F3: Digital Input Option

No. (Hex.)	Name	Description	Default (Range)	Ref.
F3-01 (0390)	Digital Input Function Selection	<p>V/f CL-V/f OLV CLV AOLV OLV/PM AOLV/PM CLV/PM EZOLV</p> <p>Sets the data format of digital input signals. This parameter is enabled when o1-03 = 0 or 1 [Frequency Display Unit Selection = 0.01 Hz or 0.01% (100% = E1-04)].</p> <p>Note:</p> <p>When o1-03 = 2 or 3 [Revolutions Per Minute (RPM) or User Units (o1-10 & o1-11)], the input signal will be BCD. The o1-03 value sets the setting units.</p> <p>0 : BCD, 1% units 1 : BCD, 0.1% units 2 : BCD, 0.01% units 3 : BCD, 1 Hz units 4 : BCD, 0.1 Hz units 5 : BCD, 0.01 Hz units 6 : BCD (5-digit), 0.02 Hz 7 : Binary input 8 : Multi-Function Digital Input</p>	0 (0 - 8)	808
F3-03 (03B9)	Digital Input Data Length Select	<p>V/f CL-V/f OLV CLV AOLV OLV/PM AOLV/PM CLV/PM EZOLV</p> <p>Sets the number of bits to set the frequency reference with DI-A3. 0 : 8-bit 1 : 12-bit 2 : 16-bit</p>	2 (0 - 2)	809
F3-10 (0BE3) Expert	Terminal D0 Function Selection	<p>V/f CL-V/f OLV CLV AOLV OLV/PM AOLV/PM CLV/PM EZOLV</p> <p>Sets the function for terminal D0 of the DI-A3 option when F3-01 = 8 [Digital Input Function Selection = Multi-Function Digital Input].</p>	F (1 - 19F)	809
F3-11 (0BE4) Expert	Terminal D1 Function Selection	<p>V/f CL-V/f OLV CLV AOLV OLV/PM AOLV/PM CLV/PM EZOLV</p> <p>Sets the function for terminal D1 of the DI-A3 option when F3-01 = 8 [Digital Input Function Selection = Multi-Function Digital Input].</p>	F (1 - 19F)	810
F3-12 (0BE5) Expert	Terminal D2 Function Selection	<p>V/f CL-V/f OLV CLV AOLV OLV/PM AOLV/PM CLV/PM EZOLV</p> <p>Sets the function for terminal D2 of the DI-A3 option when F3-01 = 8 [Digital Input Function Selection = Multi-Function Digital Input].</p>	F (1 - 19F)	810
F3-13 (0BE6) Expert	Terminal D3 Function Selection	<p>V/f CL-V/f OLV CLV AOLV OLV/PM AOLV/PM CLV/PM EZOLV</p> <p>Sets the function for terminal D3 of the DI-A3 option when F3-01 = 8 [Digital Input Function Selection = Multi-Function Digital Input].</p>	F (1 - 19F)	810
F3-14 (0BE7) Expert	Terminal D4 Function Selection	<p>V/f CL-V/f OLV CLV AOLV OLV/PM AOLV/PM CLV/PM EZOLV</p> <p>Sets the function for terminal D4 of the DI-A3 option when F3-01 = 8 [Digital Input Function Selection = Multi-Function Digital Input].</p>	F (1 - 19F)	810

No. (Hex.)	Name	Description	Default (Range)	Ref.
F3-15 (0BE8) Expert	Terminal D5 Function Selection	V/f CL-V/f OLV CLV AOLV OLV/PM AOLV/PM CLV/PM EZOLV Sets the function for terminal D5 of the DI-A3 option when F3-01 = 8 [Digital Input Function Selection = Multi-Function Digital Input].	F (1 - 19F)	810
F3-16 (0BE9) Expert	Terminal D6 Function Selection	V/f CL-V/f OLV CLV AOLV OLV/PM AOLV/PM CLV/PM EZOLV Sets the function for terminal D6 of the DI-A3 option when F3-01 = 8 [Digital Input Function Selection = Multi-Function Digital Input].	F (1 - 19F)	810
F3-17 (0BEA) Expert	Terminal D7 Function Selection	V/f CL-V/f OLV CLV AOLV OLV/PM AOLV/PM CLV/PM EZOLV Sets the function for terminal D7 of the DI-A3 option when F3-01 = 8 [Digital Input Function Selection = Multi-Function Digital Input].	F (1 - 19F)	810
F3-18 (0BEB) Expert	Terminal D8 Function Selection	V/f CL-V/f OLV CLV AOLV OLV/PM AOLV/PM CLV/PM EZOLV Sets the function for terminal D8 of the DI-A3 option when F3-01 = 8 [Digital Input Function Selection = Multi-Function Digital Input].	F (1 - 19F)	810
F3-19 (0BEC) Expert	Terminal D9 Function Selection	V/f CL-V/f OLV CLV AOLV OLV/PM AOLV/PM CLV/PM EZOLV Sets the function for terminal D9 of the DI-A3 option when F3-01 = 8 [Digital Input Function Selection = Multi-Function Digital Input].	F (1 - 19F)	811
F3-20 (0BED) Expert	Terminal DA Function Selection	V/f CL-V/f OLV CLV AOLV OLV/PM AOLV/PM CLV/PM EZOLV Sets the function for terminal DA of the DI-A3 option when F3-01 = 8 [Digital Input Function Selection = Multi-Function Digital Input].	F (1 - 19F)	811
F3-21 (0BEE) Expert	Terminal DB Function Selection	V/f CL-V/f OLV CLV AOLV OLV/PM AOLV/PM CLV/PM EZOLV Sets the function for terminal DB of the DI-A3 option when F3-01 = 8 [Digital Input Function Selection = Multi-Function Digital Input].	F (1 - 19F)	811
F3-22 (0BEF) Expert	Terminal DC Function Selection	V/f CL-V/f OLV CLV AOLV OLV/PM AOLV/PM CLV/PM EZOLV Sets the function for terminal DC of the DI-A3 option when F3-01 = 8 [Digital Input Function Selection = Multi-Function Digital Input].	F (1 - 19F)	811
F3-23 (0BF0) Expert	Terminal DD Function Selection	V/f CL-V/f OLV CLV AOLV OLV/PM AOLV/PM CLV/PM EZOLV Sets the function for terminal DD of the DI-A3 option when F3-01 = 8 [Digital Input Function Selection = Multi-Function Digital Input].	F (1 - 19F)	811
F3-24 (0BF1) Expert	Terminal DE Function Selection	V/f CL-V/f OLV CLV AOLV OLV/PM AOLV/PM CLV/PM EZOLV Sets the function for terminal DE of the DI-A3 option when F3-01 = 8 [Digital Input Function Selection = Multi-Function Digital Input].	F (1 - 19F)	811
F3-25 (0BF2) Expert	Terminal DF Function Selection	V/f CL-V/f OLV CLV AOLV OLV/PM AOLV/PM CLV/PM EZOLV Sets the function for terminal DF of the DI-A3 option when F3-01 = 8 [Digital Input Function Selection = Multi-Function Digital Input].	F (1 - 19F)	811

◆ F4: Analog Monitor Option

No. (Hex.)	Name	Description	Default (Range)	Ref.
F4-01 (0391)	Terminal V1 Function Selection	V/f CL-V/f OLV CLV AOLV OLV/PM AOLV/PM CLV/PM EZOLV Sets the monitor signal (Ux-xx) output from terminal V1. Note: Set the x-xx part of the Ux-xx [Monitor]. For example, set F4-01 = 102 to monitor U1-02 [Output Frequency]. When the x part of Ux is a letter, replace the letter (hexadecimal number) with a decimal number. For example, set F4-01 = 1301 to monitor Ud-01.	102 (000 - 9999)	812
F4-02 (0392) RUN	Terminal V1 Gain	V/f CL-V/f OLV CLV AOLV OLV/PM AOLV/PM CLV/PM EZOLV Sets the gain of the monitor signal that is sent from terminal V1. Sets the analog signal output level from the terminal V1 at 10 V or 20 mA as 100% when an output for monitoring items is 100%.	100.0% (-999.9 - +999.9%)	812
F4-03 (0393)	Terminal V2 Function Selection	V/f CL-V/f OLV CLV AOLV OLV/PM AOLV/PM CLV/PM EZOLV Sets the monitor signal (Ux-xx) output from terminal V2. Note: Set the x-xx part of the Ux-xx [Monitor]. For example, set F4-03 = 103 to monitor U1-03 [Output Current]. When the x part of Ux is a letter, replace the letter (hexadecimal number) with a decimal number. For example, set F4-03 = 1301 to monitor Ud-01.	103 (000 - 9999)	812
F4-04 (0394) RUN	Terminal V2 Gain	V/f CL-V/f OLV CLV AOLV OLV/PM AOLV/PM CLV/PM EZOLV Sets the gain of the monitor signal that is sent from terminal V2. Sets the analog signal output level from terminal V2 at 10 V or 20 mA as 100% when an output for monitoring items is 100%.	50.0% (-999.9 - +999.9%)	813
F4-05 (0395) RUN	Terminal V1 Bias	V/f CL-V/f OLV CLV AOLV OLV/PM AOLV/PM CLV/PM EZOLV Sets the bias of the monitor signal that is sent from terminal V1. When an output for monitoring items is 0%, this parameter sets the analog signal output level from the V1 terminal as a percentage of 10 V or 20 mA.	0.0% (-999.9 - +999.9%)	813

No. (Hex.)	Name	Description	Default (Range)	Ref.
F4-06 (0396) RUN	Terminal V2 Bias	V/f CL-V/f OLV CLV AOLV OLV/PM AOLV/PM CLV/PM EZOLV Sets the bias of the monitor signal that is sent from terminal V2. Set the level of the analog signal sent from the V2 terminal at 10 V or 20 mA as 100% when an output for monitoring items is 0%.	0.0% (-999.9 - +999.9%)	813
F4-07 (0397)	Terminal V1 Signal Level	V/f CL-V/f OLV CLV AOLV OLV/PM AOLV/PM CLV/PM EZOLV Sets the output signal level for terminal V1. 0 : 0 to 10 V 1 : -10 to 10 V	0 (0, 1)	813
F4-08 (0398)	Terminal V2 Signal Level	V/f CL-V/f OLV CLV AOLV OLV/PM AOLV/PM CLV/PM EZOLV Sets the output signal level for terminal V2. 0 : 0 to 10 V 1 : -10 to 10 V	0 (0, 1)	813

◆ F5: Digital Output Option

No. (Hex.)	Name	Description	Default (Range)	Ref.
F5-01 (0399)	Terminal P1-PC Function Select	V/f CL-V/f OLV CLV AOLV OLV/PM AOLV/PM CLV/PM EZOLV Sets the function of terminal P1-PC on the DO-A3 option. Set <i>F5-09 = 2 [DO-A3 Output Mode Selection = Programmable (F5-01 to F5-08)]</i> to enable this function.	0 (0 - 1A7)	815
F5-02 (039A)	Terminal P2-PC Function Select	V/f CL-V/f OLV CLV AOLV OLV/PM AOLV/PM CLV/PM EZOLV Sets the function of terminal P2-PC on the DO-A3 option. Set <i>F5-09 = 2 [DO-A3 Output Mode Selection = Programmable (F5-01 to F5-08)]</i> to enable this function.	1 (0 - 1A7)	815
F5-03 (039B)	Terminal P3-PC Function Select	V/f CL-V/f OLV CLV AOLV OLV/PM AOLV/PM CLV/PM EZOLV Sets the function of terminal P3-PC on the DO-A3 option. Set <i>F5-09 = 2 [DO-A3 Output Mode Selection = Programmable (F5-01 to F5-08)]</i> to enable this function.	2 (0 - 1A7)	815
F5-04 (039C)	Terminal P4-PC Function Select	V/f CL-V/f OLV CLV AOLV OLV/PM AOLV/PM CLV/PM EZOLV Sets the function of terminal P4-PC on the DO-A3 option. Set <i>F5-09 = 2 [DO-A3 Output Mode Selection = Programmable (F5-01 to F5-08)]</i> to enable this function.	4 (0 - 1A7)	815
F5-05 (039D)	Terminal P5-PC Function Select	V/f CL-V/f OLV CLV AOLV OLV/PM AOLV/PM CLV/PM EZOLV Sets the function of terminal P5-PC on the DO-A3 option. Set <i>F5-09 = 2 [DO-A3 Output Mode Selection = Programmable (F5-01 to F5-08)]</i> to enable this function.	6 (0 - 1A7)	815
F5-06 (039E)	Terminal P6-PC Function Select	V/f CL-V/f OLV CLV AOLV OLV/PM AOLV/PM CLV/PM EZOLV Sets the function of terminal P6-PC on the DO-A3 option. Set <i>F5-09 = 2 [DO-A3 Output Mode Selection = Programmable (F5-01 to F5-08)]</i> to enable this function.	37 (0 - 1A7)	816
F5-07 (039F)	Terminal M1-M2 Function Select	V/f CL-V/f OLV CLV AOLV OLV/PM AOLV/PM CLV/PM EZOLV Sets the function of terminal M3-M2 on the DO-A3 option. Set <i>F5-09 = 2 [DO-A3 Output Mode Selection = Programmable (F5-01 to F5-08)]</i> to enable this function.	F (0 - 1A7)	816
F5-08 (03A0)	Terminal M3-M4 Function Select	V/f CL-V/f OLV CLV AOLV OLV/PM AOLV/PM CLV/PM EZOLV Sets the function of terminal M3-M4 on the DO-A3 option. Set <i>F5-09 = 2 [DO-A3 Output Mode Selection = Programmable (F5-01 to F5-08)]</i> to enable this function.	F (0 - 1A7)	816
F5-09 (03A1)	DO-A3 Output Mode Selection	V/f CL-V/f OLV CLV AOLV OLV/PM AOLV/PM CLV/PM EZOLV Sets the output mode of signals from the DO-A3 option. 0 : Predefined Individual Outputs 1 : Binary Output 2 : Programmable (F5-01 to F5-08)	0 (0 - 2)	816

◆ F6: Communication Options

No. (Hex.)	Name	Description	Default (Range)	Ref.
F6-01 (03A2)	Communication Error Selection	V/f CL-V/f OLV CLV AOLV OLV/PM AOLV/PM CLV/PM EZOLV Sets the method to stop the motor or let the motor continue operating when the drive detects <i>bUS [Option Communication Error]</i> . 0 : Ramp to Stop 1 : Coast to Stop 2 : Fast Stop (Use C1-09) 3 : Alarm Only 4 : Alarm (Run at d1-04) 5 : Alarm - Ramp Stop	1 (0 - 5)	822
F6-02 (03A3)	Comm External Fault (EF0) Detect	V/f CL-V/f OLV CLV AOLV OLV/PM AOLV/PM CLV/PM EZOLV Sets the conditions at which <i>EF0 [Option Card External Fault]</i> is detected. 0 : Always Detected 1 : Detected during RUN Only	0 (0, 1)	823

11.9 F: Options

No. (Hex.)	Name	Description	Default (Range)	Ref.
F6-03 (03A4)	Comm External Fault (EF0) Select	<p><input type="checkbox"/> V/f <input type="checkbox"/> CL-V/f <input type="checkbox"/> OLV <input type="checkbox"/> CLV <input type="checkbox"/> AOLV <input type="checkbox"/> OLV/PM <input type="checkbox"/> AOLV/PM <input type="checkbox"/> CLV/PM <input type="checkbox"/> EZOLV</p> <p>Sets the method to stop the motor or let the motor continue operating when the drive detects an <i>EF0</i> [Option Card External Fault].</p> <p>0 : Ramp to Stop 1 : Coast to Stop 2 : Fast Stop (Use C1-09) 3 : Alarm Only</p>	1 (0 - 3)	823
F6-04 (03A5)	bUS Error Detection Time	<p><input type="checkbox"/> V/f <input type="checkbox"/> CL-V/f <input type="checkbox"/> OLV <input type="checkbox"/> CLV <input type="checkbox"/> AOLV <input type="checkbox"/> OLV/PM <input type="checkbox"/> AOLV/PM <input type="checkbox"/> CLV/PM <input type="checkbox"/> EZOLV</p> <p>Sets the delay time for the drive to detect <i>bUS</i> [Option Communication Error].</p> <p>Note: When you install an option card in the drive, the parameter value changes to 0.0 s.</p>	2.0 s (0.0 - 5.0 s)	823
F6-06 (03A7)	Torque Reference/Limit by Comm	<p><input type="checkbox"/> V/f <input type="checkbox"/> CL-V/f <input type="checkbox"/> OLV <input type="checkbox"/> CLV <input type="checkbox"/> AOLV <input type="checkbox"/> OLV/PM <input type="checkbox"/> AOLV/PM <input type="checkbox"/> CLV/PM <input type="checkbox"/> EZOLV</p> <p>Sets the function that enables and disables the torque reference and torque limit received from the communication option.</p> <p>0 : Disabled 1 : Enabled</p>	0 (0, 1)	823
F6-07 (03A8)	Multi-Step Ref @ NetRef/ComRef	<p><input type="checkbox"/> V/f <input type="checkbox"/> CL-V/f <input type="checkbox"/> OLV <input type="checkbox"/> CLV <input type="checkbox"/> AOLV <input type="checkbox"/> OLV/PM <input type="checkbox"/> AOLV/PM <input type="checkbox"/> CLV/PM <input type="checkbox"/> EZOLV</p> <p>Sets the function that enables and disables the multi-step speed reference when the frequency reference source is NetRef or ComRef (communication option card or MEMOBUS/Modbus communications).</p> <p>0 : Disable Multi-Step References 1 : Enable Multi-Step References</p>	0 (0, 1)	823
F6-08 (036A)	Comm Parameter Reset @Initialize	<p><input type="checkbox"/> V/f <input type="checkbox"/> CL-V/f <input type="checkbox"/> OLV <input type="checkbox"/> CLV <input type="checkbox"/> AOLV <input type="checkbox"/> OLV/PM <input type="checkbox"/> AOLV/PM <input type="checkbox"/> CLV/PM <input type="checkbox"/> EZOLV</p> <p>Sets the function to initialize <i>F6-xx</i> and <i>F7-xx</i> parameters when the drive is initialized with <i>A1-03</i> [Initialize Parameters].</p> <p>0 : No Reset - Parameters Retained 1 : Reset Back to Factory Default</p>	0 (0, 1)	824
F6-10 (03B6)	CC-Link Node Address	<p><input type="checkbox"/> V/f <input type="checkbox"/> CL-V/f <input type="checkbox"/> OLV <input type="checkbox"/> CLV <input type="checkbox"/> AOLV <input type="checkbox"/> OLV/PM <input type="checkbox"/> AOLV/PM <input type="checkbox"/> CLV/PM <input type="checkbox"/> EZOLV</p> <p>Sets the node address for CC-Link communication. Restart the drive after you change the parameter setting.</p> <p>Note: Be sure to set a node address that is different than all other node addresses. Do not set this parameter to 0. Incorrect parameter settings will cause <i>AEr</i> [Station Address Setting Error] errors and the L.ERR LED on the option will come on.</p>	0 (0 - 64)	824
F6-11 (03B7)	CC-Link Communication Speed	<p><input type="checkbox"/> V/f <input type="checkbox"/> CL-V/f <input type="checkbox"/> OLV <input type="checkbox"/> CLV <input type="checkbox"/> AOLV <input type="checkbox"/> OLV/PM <input type="checkbox"/> AOLV/PM <input type="checkbox"/> CLV/PM <input type="checkbox"/> EZOLV</p> <p>Sets the communication speed for CC-Link communication. Restart the drive after you change the parameter setting.</p> <p>0 : 156 kbps 1 : 625 kbps 2 : 2.5 Mbps 3 : 5 Mbps 4 : 10 Mbps</p>	0 (0 - 4)	824
F6-14 (03BB)	BUS Error Auto Reset	<p><input type="checkbox"/> V/f <input type="checkbox"/> CL-V/f <input type="checkbox"/> OLV <input type="checkbox"/> CLV <input type="checkbox"/> AOLV <input type="checkbox"/> OLV/PM <input type="checkbox"/> AOLV/PM <input type="checkbox"/> CLV/PM <input type="checkbox"/> EZOLV</p> <p>Sets the automatic reset function for <i>bUS</i> [Option Communication Errors].</p> <p>0 : Disable 1 : Enabled</p>	0 (0, 1)	824
F6-15 (0B5B)	Comm. Option Parameters Reload	<p><input type="checkbox"/> V/f <input type="checkbox"/> CL-V/f <input type="checkbox"/> OLV <input type="checkbox"/> CLV <input type="checkbox"/> AOLV <input type="checkbox"/> OLV/PM <input type="checkbox"/> AOLV/PM <input type="checkbox"/> CLV/PM <input type="checkbox"/> EZOLV</p> <p>Sets the update method when you change <i>F6-xx</i>, <i>F7-xx</i> [Communication Options].</p> <p>0 : Reload at Next Power Cycle 1 : Reload Now 2 : Cancel Reload Request</p>	0 (0 - 2)	825
F6-16 (0B8A)	Gateway Mode	<p><input type="checkbox"/> V/f <input type="checkbox"/> CL-V/f <input type="checkbox"/> OLV <input type="checkbox"/> CLV <input type="checkbox"/> AOLV <input type="checkbox"/> OLV/PM <input type="checkbox"/> AOLV/PM <input type="checkbox"/> CLV/PM <input type="checkbox"/> EZOLV</p> <p>Sets the gateway mode operation and the number of connected slave drives.</p> <p>0 : Disabled 1 : Enabled: 1 Slave Drives 2 : Enabled: 2 Slave Drives 3 : Enabled: 3 Slave Drives 4 : Enabled: 4 Slave Drives</p>	0 (0 to 4)	825
F6-20 (036B)	MECHATROLINK Station Address	<p><input type="checkbox"/> V/f <input type="checkbox"/> CL-V/f <input type="checkbox"/> OLV <input type="checkbox"/> CLV <input type="checkbox"/> AOLV <input type="checkbox"/> OLV/PM <input type="checkbox"/> AOLV/PM <input type="checkbox"/> CLV/PM <input type="checkbox"/> EZOLV</p> <p>Sets the station address for MECHATROLINK communication. Restart the drive after you change the parameter setting.</p> <p>Note:</p> <ul style="list-style-type: none"> The setting range changes if using MECHATROLINK-II or MECHATROLINK-III: <ul style="list-style-type: none"> –MECHATROLINK-II (SI-T3) range: 20 - 3F –MECHATROLINK-III (SI-ET3) range: 03 - EF Be sure to set a node address that is different than all other node addresses. Incorrect parameter settings will cause <i>AEr</i> [Station Address Setting Error] errors and the L.ERR LED on the option will come on. When the station address is 20 or 3F, the drive detects <i>AEr</i> errors. 	0021h (MECHATROLINK-II: 0020h - 003Fh, MECHATROLINK-III: 0003h - 00EFh)	825

No. (Hex.)	Name	Description	Default (Range)	Ref.
F6-21 (036C)	MECHATROLINK Frame Size	V/f CL-V/f OLV CLV AOLV OLV/PM AOLV/PM CLV/PM EZOLV Sets the frame size for MECHATROLINK communication. Restart the drive after you change the parameter setting. 0 : 32byte (M-2) / 64byte (M-3) 1 : 17byte (M-2) / 32byte (M-3)	0 (0, 1)	825
F6-22 (036D)	MECHATROLINK Link Speed	V/f CL-V/f OLV CLV AOLV OLV/PM AOLV/PM CLV/PM EZOLV Sets the communications speed for MECHATROLINK-II. Restart the drive after you change the parameter setting. Note: This parameter is only available with the MECHATROLINK-II option. 0 : 10 Mbps 1 : 4 Mbps	0 (0, 1)	825
F6-23 (036E)	MECHATROLINK Monitor Select (E)	V/f CL-V/f OLV CLV AOLV OLV/PM AOLV/PM CLV/PM EZOLV Sets the MEMOBUS register used for the monitor functions of INV_CTL (drive operation control command) and INV_I/O (drive I/O control command). Restart the drive after you change the parameter setting.	0000h (0000h - FFFFh)	826
F6-24 (036F)	MECHATROLINK Monitor Select (F)	V/f CL-V/f OLV CLV AOLV OLV/PM AOLV/PM CLV/PM EZOLV Sets the MEMOBUS register used for the monitor functions of INV_CTL (drive operation control command) and INV_I/O (drive I/O control command). Restart the drive after you change the parameter setting.	0000h (0000h - FFFFh)	826
F6-25 (03C9)	MECHATROLINK Watchdog Error Sel	V/f CL-V/f OLV CLV AOLV OLV/PM AOLV/PM CLV/PM EZOLV Sets the method to stop the motor or let the motor continue operating when the drive detects an E5 [MECHATROLINK Watchdog Timer Err]. 0 : Ramp to Stop 1 : Coast to Stop 2 : Fast Stop (Use C1-09) 3 : Alarm Only	1 (0 - 3)	826
F6-26 (03CA)	MECHATROLINK Allowable No of Err	V/f CL-V/f OLV CLV AOLV OLV/PM AOLV/PM CLV/PM EZOLV Sets the number of times that the option must detect a bUS alarm to cause a bUS [Option Communication Error].	2 (2 - 10 times)	826
F6-30 (03CB)	PROFIBUS-DP Node Address	V/f CL-V/f OLV CLV AOLV OLV/PM AOLV/PM CLV/PM EZOLV Sets the node address for PROFIBUS-DP communication. Restart the drive after you change the parameter setting. Note: Be sure to set an address that is different than all other node addresses. Do not set this parameter to 0.	0 (0 - 125)	827
F6-31 (03CC)	PROFIBUS-DP Clear Mode Selection	V/f CL-V/f OLV CLV AOLV OLV/PM AOLV/PM CLV/PM EZOLV Sets what the drive will do after it receives the Clear Mode command. 0 : Reset 1 : Hold Previous State	0 (0, 1)	827
F6-32 (03CD)	PROFIBUS-DP Data Format Select	V/f CL-V/f OLV CLV AOLV OLV/PM AOLV/PM CLV/PM EZOLV Sets the data format of PROFIBUS-DP communication. Restart the drive after you change the parameter setting. 0 : PPO Type 1 : Conventional 2 : PPO (bit0) 3 : PPO (Enter) 4 : Conventional (Enter) 5 : PPO (bit0, Enter)	0 (0 - 5)	827
F6-35 (03D0)	CANopen Node ID Selection	V/f CL-V/f OLV CLV AOLV OLV/PM AOLV/PM CLV/PM EZOLV Sets the node address for CANopen communication. Restart the drive after you change the parameter setting. Note: Be sure to set an address that is different than all other node addresses. Do not set this parameter to 0. Incorrect parameter settings will cause AEr [Station Address Setting Error] errors and the L.ERR LED on the option will come on.	0 (0 - 126)	827
F6-36 (03D1)	CANopen Communication Speed	V/f CL-V/f OLV CLV AOLV OLV/PM AOLV/PM CLV/PM EZOLV Sets the CANopen communications speed. Restart the drive after you change the parameter setting. 0 : Auto-detection 1 : 10 kbps 2 : 20 kbps 3 : 50 kbps 4 : 125 kbps 5 : 250 kbps 6 : 500 kbps 7 : 800 kbps 8 : 1 Mbps	0 (0 - 8)	827

11.9 F: Options

No. (Hex.)	Name	Description	Default (Range)	Ref.
F6-45 (02FB)	BACnet Node Address	<p>V/f CL-V/f OLV CLV AOLV OLV/PM AOLV/PM CLV/PM EZOLV</p> <p>Sets the node address for BACnet communication.</p> <p>Note: Be sure to set an address that is different than all other node addresses. Do not set this parameter to 0.</p>	1 (0 - 127)	828
F6-46 (02FC)	BACnet Baud Rate	<p>V/f CL-V/f OLV CLV AOLV OLV/PM AOLV/PM CLV/PM EZOLV</p> <p>Sets the BACnet communications speed.</p> <p>0 : 1200 bps 1 : 2400 bps 2 : 4800 bps 3 : 9600 bps 4 : 19.2 kbps 5 : 38.4 kbps 6 : 57.6 kbps 7 : 76.8 kbps 8 : 115.2 kbps</p>	3 (0 - 8)	828
F6-47 (02FD)	Rx to Tx Wait Time	<p>V/f CL-V/f OLV CLV AOLV OLV/PM AOLV/PM CLV/PM EZOLV</p> <p>Sets the wait time for the drive to receive and send BACnet communication.</p>	5 ms (5 - 65 ms)	828
F6-48 (02FE)	BACnet Device Object Identifier ⁰	<p>V/f CL-V/f OLV CLV AOLV OLV/PM AOLV/PM CLV/PM EZOLV</p> <p>Sets the last word of BACnet communication addresses.</p>	0 (0 - FFFF)	828
F6-49 (02FF)	BACnet Device Object Identifier ¹	<p>V/f CL-V/f OLV CLV AOLV OLV/PM AOLV/PM CLV/PM EZOLV</p> <p>Sets the last word of BACnet communication addresses.</p>	0 (0 - 3F)	828
F6-50 (03C1)	DeviceNet MAC Address	<p>V/f CL-V/f OLV CLV AOLV OLV/PM AOLV/PM CLV/PM EZOLV</p> <p>Sets the MAC address for DeviceNet communication. Restart the drive after you change the parameter setting.</p> <p>Note: Be sure to set a MAC address that is different than all other node addresses. Do not set this parameter to 0. Incorrect parameter settings will cause <i>AEr</i> [Station Address Setting Error] errors and the MS LED on the option will flash.</p>	0 (0 - 64)	829
F6-51 (03C2)	DeviceNet Baud Rate	<p>V/f CL-V/f OLV CLV AOLV OLV/PM AOLV/PM CLV/PM EZOLV</p> <p>Sets the DeviceNet communications speed. Restart the drive after you change the parameter setting.</p> <p>0 : 125 kbps 1 : 250 kbps 2 : 500 kbps 3 : Adjustable from Network 4 : Detect Automatically</p>	0 (0 - 4)	829
F6-52 (03C3)	DeviceNet PCA Setting	<p>V/f CL-V/f OLV CLV AOLV OLV/PM AOLV/PM CLV/PM EZOLV</p> <p>Sets the format of data that the DeviceNet communication master sends to the drive.</p>	21 (0 - 255)	829
F6-53 (03C4)	DeviceNet PPA Setting	<p>V/f CL-V/f OLV CLV AOLV OLV/PM AOLV/PM CLV/PM EZOLV</p> <p>Sets the format of data that the drive sends to the DeviceNet communication master.</p>	71 (0 - 255)	829
F6-54 (03C5)	DeviceNet Idle Fault Detection	<p>V/f CL-V/f OLV CLV AOLV OLV/PM AOLV/PM CLV/PM EZOLV</p> <p>If the drive does not receive data from the DeviceNet or EtherNet/IP master, this parameter sets the function to detect <i>EF0</i> [Option Card External Fault].</p> <p>0 : Enabled 1 : Disabled, No Fault Detection 2 : Vendor Specific 3 : RUN Forward 4 : RUN Reverse</p>	0 (0 - 4)	829
F6-55 (03C6)	DeviceNet Baud Rate Monitor	<p>V/f CL-V/f OLV CLV AOLV OLV/PM AOLV/PM CLV/PM EZOLV</p> <p>Sets the function to see the actual DeviceNet communications speed using the keypad. This parameter functions as a monitor only.</p> <p>0 : 125 kbps 1 : 250 kbps 2 : 500 kbps</p>	0 (0 - 2)	830
F6-56 (03D7)	DeviceNet Speed Scaling	<p>V/f CL-V/f OLV CLV AOLV OLV/PM AOLV/PM CLV/PM EZOLV</p> <p>Sets the speed scale for DeviceNet communication.</p>	0 (-15 - +15)	830
F6-57 (03D8)	DeviceNet Current Scaling	<p>V/f CL-V/f OLV CLV AOLV OLV/PM AOLV/PM CLV/PM EZOLV</p> <p>Sets the current scale of the DeviceNet communication master.</p>	0 (-15 - +15)	830
F6-58 (03D9)	DeviceNet Torque Scaling	<p>V/f CL-V/f OLV CLV AOLV OLV/PM AOLV/PM CLV/PM EZOLV</p> <p>Sets the torque scale of the DeviceNet communication master.</p>	0 (-15 - +15)	830
F6-59 (03DA)	DeviceNet Power Scaling	<p>V/f CL-V/f OLV CLV AOLV OLV/PM AOLV/PM CLV/PM EZOLV</p> <p>Sets the power scale of the DeviceNet communication master.</p>	0 (-15 - +15)	830
F6-60 (03DB)	DeviceNet Voltage Scaling	<p>V/f CL-V/f OLV CLV AOLV OLV/PM AOLV/PM CLV/PM EZOLV</p> <p>Sets the voltage scale of the DeviceNet communication master.</p>	0 (-15 - +15)	830

No. (Hex.)	Name	Description	Default (Range)	Ref.
F6-61 (03DC)	DeviceNet Time Scaling	V/f CL-V/f OLV CLV AOLV OLV/PM AOLV/PM CLV/PM EZOLV Sets the time scale of the DeviceNet communication master.	0 (-15 - +15)	830
F6-62 (03DD)	DeviceNet Heartbeat Interval	V/f CL-V/f OLV CLV AOLV OLV/PM AOLV/PM CLV/PM EZOLV Sets the heartbeat for DeviceNet communication. Set this parameter to 0 to disable the heartbeat function.	0 (0 - 10)	830
F6-63 (03DE)	DeviceNet Network MAC ID	V/f CL-V/f OLV CLV AOLV OLV/PM AOLV/PM CLV/PM EZOLV Sets the function to see the actual DeviceNet MAC address using the keypad. This parameter functions as a monitor only.	0 (0 - 63)	831
F6-64 (03DF)	Dynamic Out Assembly 109 Param1	V/f CL-V/f OLV CLV AOLV OLV/PM AOLV/PM CLV/PM EZOLV Sets Configurable Output 1 written to the MEMOBUS register.	0000H (0000H - FFFFH)	831
F6-65 (03E0)	Dynamic Out Assembly 109 Param2	V/f CL-V/f OLV CLV AOLV OLV/PM AOLV/PM CLV/PM EZOLV Sets Configurable Output 2 written to the MEMOBUS register.	0000H (0000H - FFFFH)	831
F6-66 (03E1)	Dynamic Out Assembly 109 Param3	V/f CL-V/f OLV CLV AOLV OLV/PM AOLV/PM CLV/PM EZOLV Sets Configurable Output 3 written to the MEMOBUS register.	0000H (0000H - FFFFH)	831
F6-67 (03E2)	Dynamic Out Assembly 109 Param4	V/f CL-V/f OLV CLV AOLV OLV/PM AOLV/PM CLV/PM EZOLV Sets Configurable Output 4 written to the MEMOBUS register.	0000H (0000H - FFFFH)	831
F6-68 (03E3)	Dynamic In Assembly 159 Param 1	V/f CL-V/f OLV CLV AOLV OLV/PM AOLV/PM CLV/PM EZOLV Sets Configurable Input 1 read from the MEMOBUS register.	0000H (0000H - FFFFH)	831
F6-69 (03E4)	Dynamic In Assembly 159 Param 2	V/f CL-V/f OLV CLV AOLV OLV/PM AOLV/PM CLV/PM EZOLV Sets Configurable Input 2 read from the MEMOBUS register.	0000H (0000H - FFFFH)	831
F6-70 (03C7)	Dynamic In Assembly 159 Param 3	V/f CL-V/f OLV CLV AOLV OLV/PM AOLV/PM CLV/PM EZOLV Sets Configurable Input 3 read from the MEMOBUS register.	0000H (0000H - FFFFH)	831
F6-71 (03C8)	Dynamic In Assembly 159 Param 4	V/f CL-V/f OLV CLV AOLV OLV/PM AOLV/PM CLV/PM EZOLV Sets Configurable Input 4 read from the MEMOBUS register.	0000H (0000H - FFFFH)	831
F6-72 (081B)	PowerLink Node Address	V/f CL-V/f OLV CLV AOLV OLV/PM AOLV/PM CLV/PM EZOLV Sets the node ID for PowerLink communication. Note: Be sure to set an address that is different than all other node addresses. Do not set this parameter to 0.	0 (0 - 255)	831

◆ F7: Communication Options

No. (Hex.)	Name	Description	Default (Range)	Ref.
F7-01 (03E5)	IP Address 1	V/f CL-V/f OLV CLV AOLV OLV/PM AOLV/PM CLV/PM EZOLV Sets the first octet of the IP Address for the device that is connecting to the network. Restart the drive after you change this parameter. Note: When F7-13 = 0 [Address Mode at Startup = Static]: • Use parameters F7-01 to F7-04 [IP Address 1 to 4] to set the IP Address. Be sure to set a different IP address for each drive on the network. • Also set parameters F7-05 to F7-12 [Subnet Mask 1 to 4, Gateway Address 1 to 4].	192 (0 - 255)	831
F7-02 (03E6)	IP Address 2	V/f CL-V/f OLV CLV AOLV OLV/PM AOLV/PM CLV/PM EZOLV Sets the second octet of the IP Address for the device that is connecting to the network. Restart the drive after you change this parameter. Note: When F7-13 = 0 [Address Mode at Startup = Static]: • Use parameters F7-01 to F7-04 [IP Address 1 to 4] to set the IP Address. Be sure to set a different IP address for each drive on the network. • Also set parameters F7-05 to F7-12 [Subnet Mask 1 to 4, Gateway Address 1 to 4].	168 (0 - 255)	831
F7-03 (03E7)	IP Address 3	V/f CL-V/f OLV CLV AOLV OLV/PM AOLV/PM CLV/PM EZOLV Sets the third octet of the IP Address for the device that is connecting to the network. Restart the drive after you change this parameter. Note: When F7-13 = 0 [Address Mode at Startup = Static]: • Use parameters F7-01 to F7-04 [IP Address 1 to 4] to set the IP Address. Be sure to set a different IP address for each drive on the network. • Also set parameters F7-05 to F7-12 [Subnet Mask 1 to 4, Gateway Address 1 to 4].	1 (0 - 255)	831

11.9 F: Options

No. (Hex.)	Name	Description	Default (Range)	Ref.
F7-04 (03E8)	IP Address 4	<p>V/f CL-V/f OLV CLV AOLV OLV/PM AOLV/PM CLV/PM EZOLV</p> <p>Sets the fourth octet of the IP Address for the device that is connecting to the network. Restart the drive after you change this parameter.</p> <p>Note: When <i>F7-13 = 0</i> [Address Mode at Startup = Static]: <ul style="list-style-type: none"> Use parameters <i>F7-01</i> to <i>F7-04</i> [IP Address 1 to 4] to set the IP Address. Be sure to set a different IP address for each drive on the network. Also set parameters <i>F7-05</i> to <i>F7-12</i> [Subnet Mask 1 to 4, Gateway Address 1 to 4]. </p>	20 (0 - 255)	832
F7-05 (03E9)	Subnet Mask 1	<p>V/f CL-V/f OLV CLV AOLV OLV/PM AOLV/PM CLV/PM EZOLV</p> <p>Sets the first octet of the subnet mask of the connected network.</p> <p>Note: Set this parameter when <i>F7-13 = 0</i> [Address Mode at Startup = Static].</p>	255 (0 - 255)	832
F7-06 (03EA)	Subnet Mask 2	<p>V/f CL-V/f OLV CLV AOLV OLV/PM AOLV/PM CLV/PM EZOLV</p> <p>Sets the second octet of the subnet mask of the connected network.</p> <p>Note: Set this parameter when <i>F7-13 = 0</i> [Address Mode at Startup = Static].</p>	255 (0 - 255)	832
F7-07 (03EB)	Subnet Mask 3	<p>V/f CL-V/f OLV CLV AOLV OLV/PM AOLV/PM CLV/PM EZOLV</p> <p>Sets the third octet of the subnet mask of the connected network.</p> <p>Note: Set this parameter when <i>F7-13 = 0</i> [Address Mode at Startup = Static].</p>	255 (0 - 255)	832
F7-08 (03EC)	Subnet Mask 4	<p>V/f CL-V/f OLV CLV AOLV OLV/PM AOLV/PM CLV/PM EZOLV</p> <p>Sets the fourth octet of the subnet mask of the connected network.</p> <p>Note: Set this parameter when <i>F7-13 = 0</i> [Address Mode at Startup = Static].</p>	0 (0 - 255)	832
F7-09 (03ED)	Gateway Address 1	<p>V/f CL-V/f OLV CLV AOLV OLV/PM AOLV/PM CLV/PM EZOLV</p> <p>Sets the first octet of the gateway address of the connected network.</p> <p>Note: Set this parameter when <i>F7-13 = 0</i> [Address Mode at Startup = Static].</p>	192 (0 - 255)	832
F7-10 (03EE)	Gateway Address 2	<p>V/f CL-V/f OLV CLV AOLV OLV/PM AOLV/PM CLV/PM EZOLV</p> <p>Sets the second octet of the gateway address of the connected network.</p> <p>Note: Set this parameter when <i>F7-13 = 0</i> [Address Mode at Startup = Static].</p>	168 (0 - 255)	833
F7-11 (03EF)	Gateway Address 3	<p>V/f CL-V/f OLV CLV AOLV OLV/PM AOLV/PM CLV/PM EZOLV</p> <p>Sets the third octet of the gateway address of the connected network.</p> <p>Note: Set this parameter when <i>F7-13 = 0</i> [Address Mode at Startup = Static].</p>	1 (0 - 255)	833
F7-12 (03F0)	Gateway Address 4	<p>V/f CL-V/f OLV CLV AOLV OLV/PM AOLV/PM CLV/PM EZOLV</p> <p>Sets the fourth octet of the gateway address of the connected network.</p> <p>Note: Set this parameter when <i>F7-13 = 0</i> [Address Mode at Startup = Static].</p>	1 (0 - 255)	833
F7-13 (03F1)	Address Mode at Startup	<p>V/f CL-V/f OLV CLV AOLV OLV/PM AOLV/PM CLV/PM EZOLV</p> <p>Sets the method to set option card IP addresses.</p> <p>0 : Static 1 : BOOTP 2 : DHCP</p> <p>Note: <ul style="list-style-type: none"> The following setting values are available when using the PROFINET communication option card (SI-EP3). -0: Static -2: DHCP When <i>F7-13 = 0</i>, set parameters <i>F7-01</i> to <i>F7-12</i> [IP Address 1 to Gateway Address 4] to set the IP Address. Be sure to set a different IP address for each drive on the network. </p>	2 (0 - 2)	833
F7-14 (03F2)	Duplex Mode Selection	<p>V/f CL-V/f OLV CLV AOLV OLV/PM AOLV/PM CLV/PM EZOLV</p> <p>Sets the duplex mode setting method.</p> <p>0 : Half/Half 1 : Auto/Auto 2 : Full/Full 3 : Half/Auto 4 : Half/Full 5 : Auto/Half 6 : Auto/Full 7 : Full/Half 8 : Full/Auto</p>	1 (0 - 8)	833

No. (Hex.)	Name	Description	Default (Range)	Ref.
F7-15 (03F3)	Communication Speed Selection	<p>V/f CL-V/f OLV CLV AOLV OLV/PM AOLV/PM CLV/PM EZOLV</p> <p>Sets the communications speed. 10 : 10/10 Mbps 100 : 100/100 Mbps 101 : 10/100 Mbps 102 : 100/10 Mbps</p>	10 (10, 100 - 102)	834
F7-16 (03F4)	Timeout Value	<p>V/f CL-V/f OLV CLV AOLV OLV/PM AOLV/PM CLV/PM EZOLV</p> <p>Sets the detection time for a communications timeout. Note: Set this parameter to 0.0 to disable the connection timeout function.</p>	0.0 s (0.0 - 30.0 s)	834
F7-17 (03F5)	EtherNet/IP Speed Scaling Factor	<p>V/f CL-V/f OLV CLV AOLV OLV/PM AOLV/PM CLV/PM EZOLV</p> <p>Sets the scaling factor for the speed monitor in the EtherNet/IP Class ID 2AH Object.</p>	0 (-15 - +15)	834
F7-18 (03F6)	EtherNet/IP Current Scale Factor	<p>V/f CL-V/f OLV CLV AOLV OLV/PM AOLV/PM CLV/PM EZOLV</p> <p>Sets the scaling factor for the output current monitor in the EtherNet/IP Class ID 2AH Object.</p>	0 (-15 - +15)	834
F7-19 (03F7)	EtherNet/IP Torque Scale Factor	<p>V/f CL-V/f OLV CLV AOLV OLV/PM AOLV/PM CLV/PM EZOLV</p> <p>Sets the scaling factor for the torque monitor in the EtherNet/IP Class ID 2AH Object.</p>	0 (-15 - +15)	834
F7-20 (03F8)	EtherNet/IP Power Scaling Factor	<p>V/f CL-V/f OLV CLV AOLV OLV/PM AOLV/PM CLV/PM EZOLV</p> <p>Sets the scaling factor for the power monitor in the EtherNet/IP Class ID 2AH Object.</p>	0 (-15 - +15)	834
F7-21 (03F9)	EtherNet/IP Voltage Scale Factor	<p>V/f CL-V/f OLV CLV AOLV OLV/PM AOLV/PM CLV/PM EZOLV</p> <p>Sets the scaling factor for the voltage monitor in the EtherNet/IP Class ID 2AH Object.</p>	0 (-15 - +15)	834
F7-22 (03FA)	EtherNet/IP Time Scaling	<p>V/f CL-V/f OLV CLV AOLV OLV/PM AOLV/PM CLV/PM EZOLV</p> <p>Sets the scaling factor for the time monitor in the EtherNet/IP Class ID 2AH Object.</p>	0 (-15 - +15)	835
F7-23 (03FB)	Dynamic Out Param 1 for CommCard	<p>V/f CL-V/f OLV CLV AOLV OLV/PM AOLV/PM CLV/PM EZOLV</p> <p>When you use an Ethernet/IP option, sets Output Assembly 116. The drive writes the values from Output Assembly 116 to the MEMOBUS/Modbus address register that is stored for each parameter. The drive will not write the values from Output Assembly 116 to the registers when the MEMOBUS/Modbus address is 0. When you use a PROFINET option, set this parameter to set to configurable output 1.</p>	0	835
F7-24 (03FC)	Dynamic Out Param 2 for CommCard	<p>V/f CL-V/f OLV CLV AOLV OLV/PM AOLV/PM CLV/PM EZOLV</p> <p>When you use an Ethernet/IP option, sets Output Assembly 116. The drive writes the values from Output Assembly 116 to the MEMOBUS/Modbus address register that is stored for each parameter. The drive will not write the values from Output Assembly 116 to the registers when the MEMOBUS/Modbus address is 0. When you use a PROFINET option, set this parameter to set to configurable output 2.</p>	0	835
F7-25 (03FD)	Dynamic Out Param 3 for CommCard	<p>V/f CL-V/f OLV CLV AOLV OLV/PM AOLV/PM CLV/PM EZOLV</p> <p>When you use an Ethernet/IP option, sets Output Assembly 116. The drive writes the values from Output Assembly 116 to the MEMOBUS/Modbus address register that is stored for each parameter. The drive will not write the values from Output Assembly 116 to the registers when the MEMOBUS/Modbus address is 0. When you use a PROFINET option, set this parameter to set to configurable output 3.</p>	0	835
F7-26 (03FE)	Dynamic Out Param 4 for CommCard	<p>V/f CL-V/f OLV CLV AOLV OLV/PM AOLV/PM CLV/PM EZOLV</p> <p>Sets Output Assembly 116 when you use an Ethernet/IP option. The drive writes the values from Output Assembly 116 to the MEMOBUS/Modbus address register that is stored for each parameter. The drive will not write the values from Output Assembly 116 to the registers when the MEMOBUS/Modbus address is 0. When you use a ProfiNet option, set this parameter to set to configurable output 4.</p>	0	835
F7-27 (03FF)	Dynamic Out Param 5 for CommCard	<p>V/f CL-V/f OLV CLV AOLV OLV/PM AOLV/PM CLV/PM EZOLV</p> <p>When you use an Ethernet/IP option, sets Output Assembly 116. The drive writes the values from Output Assembly 116 to the MEMOBUS/Modbus address register that is stored for each parameter. The drive will not write the values from Output Assembly 116 to the registers when the MEMOBUS/Modbus address is 0. When you use a PROFINET option, set this parameter to set to configurable output 5.</p>	0	835
F7-28 (0370)	Dynamic Out Param 6 for CommCard	<p>V/f CL-V/f OLV CLV AOLV OLV/PM AOLV/PM CLV/PM EZOLV</p> <p>When you use an Ethernet/IP option, sets Output Assembly 116. The drive writes the values from Output Assembly 116 to the MEMOBUS/Modbus address register that is stored for each parameter. The drive will not write the values from Output Assembly 116 to the registers when the MEMOBUS/Modbus address is 0.</p>	0	835
F7-29 (0371)	Dynamic Out Param 7 for CommCard	<p>V/f CL-V/f OLV CLV AOLV OLV/PM AOLV/PM CLV/PM EZOLV</p> <p>When you use an Ethernet/IP option, sets Output Assembly 116. The drive writes the values from Output Assembly 116 to the MEMOBUS/Modbus address register that is stored for each parameter. The drive will not write the values from Output Assembly 116 to the registers when the MEMOBUS/Modbus address is 0.</p>	0	835
F7-30 (0372)	Dynamic Out Param 8 for CommCard	<p>V/f CL-V/f OLV CLV AOLV OLV/PM AOLV/PM CLV/PM EZOLV</p> <p>When you use an Ethernet/IP option, sets Output Assembly 116. The drive writes the values from Output Assembly 116 to the MEMOBUS/Modbus address register that is stored for each parameter. The drive will not write the values from Output Assembly 116 to the registers when the MEMOBUS/Modbus address is 0.</p>	0	835
F7-31 (0373)	Dynamic Out Param 9 for CommCard	<p>V/f CL-V/f OLV CLV AOLV OLV/PM AOLV/PM CLV/PM EZOLV</p> <p>When you use an Ethernet/IP option, sets Output Assembly 116. The drive writes the values from Output Assembly 116 to the MEMOBUS/Modbus address register that is stored for each parameter. The drive will not write the values from Output Assembly 116 to the registers when the MEMOBUS/Modbus address is 0.</p>	0	835

11.9 F: Options

No. (Hex.)	Name	Description	Default (Range)	Ref.
F7-32 (0374)	Dynamic Out Param 10 for CommCard	V/f CL-V/f OLV CLV AOLV OLV/PM AOLV/PM CLV/PM EZOLV When you use an Ethernet/IP option, sets Output Assembly 116. The drive writes the values from Output Assembly 116 to the MEMOBUS/Modbus address register that is stored for each parameter. The drive will not write the values from Output Assembly 116 to the registers when the MEMOBUS/Modbus address is 0.	0	835
F7-33 (0375)	Dynamic In Param 1 for CommCard	V/f CL-V/f OLV CLV AOLV OLV/PM AOLV/PM CLV/PM EZOLV Sets Input Assembly 166 when you use an Ethernet/IP option. The drive sends the values from the MEMOBUS/Modbus address registers stored for each parameter to Input Assembly 166. The drive returns the default register value for the option card when the MEMOBUS/Modbus address is 0 and the value sent to Input Assembly 166 is not defined. When you use a ProfiNet option, set this parameter to set to configurable input 1.	0	835
F7-34 (0376)	Dynamic In Param 2 for CommCard	V/f CL-V/f OLV CLV AOLV OLV/PM AOLV/PM CLV/PM EZOLV Sets Input Assembly 166 when you use an Ethernet/IP option. The drive sends the values from the MEMOBUS/Modbus address registers stored for each parameter to Input Assembly 166. The drive returns the default register value for the option card when the MEMOBUS/Modbus address is 0 and the value sent to Input Assembly 166 is not defined. When you use a ProfiNet option, set this parameter to set to configurable input 2.	0	835
F7-35 (0377)	Dynamic In Param 3 for CommCard	V/f CL-V/f OLV CLV AOLV OLV/PM AOLV/PM CLV/PM EZOLV Sets Input Assembly 166 when you use an Ethernet/IP option. The drive sends the values from the MEMOBUS/Modbus address registers stored for each parameter to Input Assembly 166. The drive returns the default register value for the option card when the MEMOBUS/Modbus address is 0 and the value sent to Input Assembly 166 is not defined. When you use a ProfiNet option, set this parameter to set to configurable input 3.	0	835
F7-36 (0378)	Dynamic In Param 4 for CommCard	V/f CL-V/f OLV CLV AOLV OLV/PM AOLV/PM CLV/PM EZOLV Sets Input Assembly 166 when you use an Ethernet/IP option. The drive sends the values from the MEMOBUS/Modbus address registers stored for each parameter to Input Assembly 166. The drive returns the default register value for the option card when the MEMOBUS/Modbus address is 0 and the value sent to Input Assembly 166 is not defined. When you use a ProfiNet option, set this parameter to set to configurable input 4.	0	835
F7-37 (0379)	Dynamic In Param 5 for CommCard	V/f CL-V/f OLV CLV AOLV OLV/PM AOLV/PM CLV/PM EZOLV Sets Input Assembly 166 when you use an Ethernet/IP option. The drive sends the values from the MEMOBUS/Modbus address registers stored for each parameter to Input Assembly 166. The drive returns the default register value for the option card when the MEMOBUS/Modbus address is 0 and the value sent to Input Assembly 166 is not defined. When you use a ProfiNet option, set this parameter to set to configurable input 5.	0	835
F7-38 (037A)	Dynamic In Param 6 for CommCard	V/f CL-V/f OLV CLV AOLV OLV/PM AOLV/PM CLV/PM EZOLV Sets Input Assembly 166 when you use an Ethernet/IP option. The drive sends the values from the MEMOBUS/Modbus address registers stored for each parameter to Input Assembly 166. The drive returns the default register value for the option card when the MEMOBUS/Modbus address is 0 and the value sent to Input Assembly 166 is not defined.	0	835
F7-39 (037B)	Dynamic In Param 7 for CommCard	V/f CL-V/f OLV CLV AOLV OLV/PM AOLV/PM CLV/PM EZOLV Sets Input Assembly 166 when you use an Ethernet/IP option. The drive sends the values from the MEMOBUS/Modbus address registers stored for each parameter to Input Assembly 166. The drive returns the default register value for the option card when the MEMOBUS/Modbus address is 0 and the value sent to Input Assembly 166 is not defined.	0	835
F7-40 (037C)	Dynamic In Param 8 for CommCard	V/f CL-V/f OLV CLV AOLV OLV/PM AOLV/PM CLV/PM EZOLV Sets Input Assembly 166 when you use an Ethernet/IP option. The drive sends the values from the MEMOBUS/Modbus address registers stored for each parameter to Input Assembly 166. The drive returns the default register value for the option card when the MEMOBUS/Modbus address is 0 and the value sent to Input Assembly 166 is not defined.	0	835
F7-41 (037D)	Dynamic In Param 9 for CommCard	V/f CL-V/f OLV CLV AOLV OLV/PM AOLV/PM CLV/PM EZOLV Sets Input Assembly 166 when you use an Ethernet/IP option. The drive sends the values from the MEMOBUS/Modbus address registers stored for each parameter to Input Assembly 166. The drive returns the default register value for the option card when the MEMOBUS/Modbus address is 0 and the value sent to Input Assembly 166 is not defined.	0	835
F7-42 (037E)	Dynamic In Param 10 for CommCard	V/f CL-V/f OLV CLV AOLV OLV/PM AOLV/PM CLV/PM EZOLV Sets Input Assembly 166 when you use an Ethernet/IP option. The drive sends the values from the MEMOBUS/Modbus address registers stored for each parameter to Input Assembly 166. The drive returns the default register value for the option card when the MEMOBUS/Modbus address is 0 and the value sent to Input Assembly 166 is not defined.	0	835
F7-60 (0780)	PZD1 Write (Control Word)	V/f CL-V/f OLV CLV AOLV OLV/PM AOLV/PM CLV/PM EZOLV When you use a Profibus option, set the MEMOBUS/Modbus address for PZD1 (PPO output). PZD1 (PPO output) functions as the STW when $F7-60 = 0$ to 2.	0	835
F7-61 (0781)	PZD2 Write (Frequency Reference)	V/f CL-V/f OLV CLV AOLV OLV/PM AOLV/PM CLV/PM EZOLV When you use a Profibus option, sets the MEMOBUS/Modbus address for PZD2 (PPO output). PZD2 (PPO output) functions as the HSW when $F7-61 = 0$ to 2.	0	835
F7-62 (0782)	PZD3 Write	V/f CL-V/f OLV CLV AOLV OLV/PM AOLV/PM CLV/PM EZOLV When you use a Profibus option, sets the MEMOBUS/Modbus address for PZD3 (PPO output). A value of 0, 1, or 2 will disable the PZD3 (PPO output) write operation to the MEMOBUS/Modbus register.	0	835

No. (Hex.)	Name	Description	Default (Range)	Ref.
F7-63 (0783)	PZD4 Write	V/f CL-V/f OLV CLV AOLV OLV/PM AOLV/PM CLV/PM EZOLV When you use a Profibus option, sets the MEMOBUS/Modbus address for PZD4 (PPO output). A value of 0, 1, or 2 will disable the PZD4 (PPO output) write operation to the MEMOBUS/Modbus register.	0	835
F7-64 (0784)	PZD5 Write	V/f CL-V/f OLV CLV AOLV OLV/PM AOLV/PM CLV/PM EZOLV When you use a Profibus option, sets the MEMOBUS/Modbus address for PZD5 (PPO output). A value of 0, 1, or 2 will disable the PZD5 (PPO output) write operation to the MEMOBUS/Modbus register.	0	835
F7-65 (0785)	PZD6 Write	V/f CL-V/f OLV CLV AOLV OLV/PM AOLV/PM CLV/PM EZOLV When you use a Profibus option, sets the MEMOBUS/Modbus address for PZD6 (PPO output). A value of 0, 1, or 2 will disable the PZD6 (PPO output) write operation to the MEMOBUS/Modbus register.	0	836
F7-66 (0786)	PZD7 Write	V/f CL-V/f OLV CLV AOLV OLV/PM AOLV/PM CLV/PM EZOLV When you use a Profibus option, sets the MEMOBUS/Modbus address for PZD7 (PPO output). A value of 0, 1, or 2 will disable the PZD7 (PPO output) write operation to the MEMOBUS/Modbus register.	0	836
F7-67 (0787)	PZD8 Write	V/f CL-V/f OLV CLV AOLV OLV/PM AOLV/PM CLV/PM EZOLV When you use a Profibus option, sets the MEMOBUS/Modbus address for PZD8 (PPO output). A value of 0, 1, or 2 will disable the PZD8 (PPO output) write operation to the MEMOBUS/Modbus register.	0	836
F7-68 (0788)	PZD9 Write	V/f CL-V/f OLV CLV AOLV OLV/PM AOLV/PM CLV/PM EZOLV When you use a Profibus option, sets the MEMOBUS/Modbus address for PZD9 (PPO output). A value of 0, 1, or 2 will disable the PZD9 (PPO output) write operation to the MEMOBUS/Modbus register.	0	836
F7-69 (0789)	PZD10 Write	V/f CL-V/f OLV CLV AOLV OLV/PM AOLV/PM CLV/PM EZOLV When you use a Profibus option, sets the MEMOBUS/Modbus address for PZD10 (PPO output). A value of 0, 1, or 2 will disable the PZD10 (PPO output) write operation to the MEMOBUS/Modbus register.	0	836
F7-70 (078A)	PZD1 Read (Status Word)	V/f CL-V/f OLV CLV AOLV OLV/PM AOLV/PM CLV/PM EZOLV When you use a Profibus option, sets the MEMOBUS/Modbus address for PZD1 (PPO input). PZD1 (PPO input) functions as the ZSW when <i>F7-70</i> = 0.	0	836
F7-71 (078B)	PZD2 Read (Output Frequency)	V/f CL-V/f OLV CLV AOLV OLV/PM AOLV/PM CLV/PM EZOLV When you use a Profibus option, sets the MEMOBUS/Modbus address for PZD2 (PPO input). PZD2 (PPO input) functions as the HIW when <i>F7-71</i> = 0.	0	836
F7-72 (078C)	PZD3 Read	V/f CL-V/f OLV CLV AOLV OLV/PM AOLV/PM CLV/PM EZOLV When you use a Profibus option, sets the MEMOBUS/Modbus address for PZD3 (PPO input). A value of 0 will disable the PZD3 (PPO input) load operation from the MEMOBUS/Modbus register.	0	836
F7-73 (078D)	PZD4 Read	V/f CL-V/f OLV CLV AOLV OLV/PM AOLV/PM CLV/PM EZOLV When you use a Profibus option, sets the MEMOBUS/Modbus address for PZD4 (PPO input). A value of 0 will disable the PZD4 (PPO input) load operation from the MEMOBUS/Modbus register.	0	837
F7-74 (078E)	PZD5 Read	V/f CL-V/f OLV CLV AOLV OLV/PM AOLV/PM CLV/PM EZOLV When you use a Profibus option, sets the MEMOBUS/Modbus address for PZD5 (PPO input). A value of 0 will disable the PZD5 (PPO input) load operation from the MEMOBUS/Modbus register.	0	837
F7-75 (078F)	PZD6 Read	V/f CL-V/f OLV CLV AOLV OLV/PM AOLV/PM CLV/PM EZOLV When you use a Profibus option, sets the MEMOBUS/Modbus address for PZD6 (PPO input). A value of 0 will disable the PZD6 (PPO input) load operation from the MEMOBUS/Modbus register.	0	837
F7-76 (0790)	PZD7 Read	V/f CL-V/f OLV CLV AOLV OLV/PM AOLV/PM CLV/PM EZOLV When you use a Profibus option, sets the MEMOBUS/Modbus address for PZD7 (PPO input). A value of 0 will disable the PZD7 (PPO input) load operation from the MEMOBUS/Modbus register.	0	837
F7-77 (0791)	PZD8 Read	V/f CL-V/f OLV CLV AOLV OLV/PM AOLV/PM CLV/PM EZOLV When you use a Profibus option, sets the MEMOBUS/Modbus address for PZD8 (PPO input). A value of 0 will disable the PZD8 (PPO input) load operation from the MEMOBUS/Modbus register.	0	837
F7-78 (0792)	PZD9 Read	V/f CL-V/f OLV CLV AOLV OLV/PM AOLV/PM CLV/PM EZOLV When you use a Profibus option, sets the MEMOBUS/Modbus address for PZD9 (PPO input). A value of 0 will disable the PZD9 (PPO input) load operation from the MEMOBUS/Modbus register.	0	837
F7-79 (0793)	PZD10 Read	V/f CL-V/f OLV CLV AOLV OLV/PM AOLV/PM CLV/PM EZOLV When you use a Profibus option, sets the MEMOBUS/Modbus address for PZD10 (PPO input). A value of 0 will disable the PZD10 (PPO input) load operation from the MEMOBUS/Modbus register.	0	837

11.10 H: Terminal Functions

◆ H1: Digital Inputs

No. (Hex.)	Name	Description	Default (Range)	Ref.
H1-01 (0438)	Terminal S1 Function Selection	<p>V/f CL-V/f OLV CLV AOLV OLV/PM AOLV/PM CLV/PM EZOLV</p> <p>Sets the function for MFDI terminal S1.</p> <p>Note: The default setting is <i>F</i> when you initialize the drive for <i>3-Wire Initialization</i> [A1-03 = 3330].</p>	40 (1 - 1FF)	839
H1-02 (0439)	Terminal S2 Function Selection	<p>V/f CL-V/f OLV CLV AOLV OLV/PM AOLV/PM CLV/PM EZOLV</p> <p>Sets the function for MFDI terminal S2.</p> <p>Note: The default setting is <i>F</i> when you initialize the drive for <i>3-Wire Initialization</i> [A1-03 = 3330].</p>	41 (1 - 1FF)	839
H1-03 (0400)	Terminal S3 Function Selection	<p>V/f CL-V/f OLV CLV AOLV OLV/PM AOLV/PM CLV/PM EZOLV</p> <p>Sets the function for MFDI terminal S3.</p>	24 (0 - 1FF)	839
H1-04 (0401)	Terminal S4 Function Selection	<p>V/f CL-V/f OLV CLV AOLV OLV/PM AOLV/PM CLV/PM EZOLV</p> <p>Sets the function for MFDI terminal S4.</p>	14 (0 - 1FF)	839
H1-05 (0402)	Terminal S5 Function Selection	<p>V/f CL-V/f OLV CLV AOLV OLV/PM AOLV/PM CLV/PM EZOLV</p> <p>Sets the function for MFDI terminal S5.</p> <p>Note: The default setting is <i>0</i> when the drive is initialized for <i>3-Wire Initialization</i> [A1-03 = 3330].</p>	3 (0 - 1FF)	840
H1-06 (0403)	Terminal S6 Function Selection	<p>V/f CL-V/f OLV CLV AOLV OLV/PM AOLV/PM CLV/PM EZOLV</p> <p>Sets the function for MFDI terminal S6.</p> <p>Note: The default setting is <i>3</i> when the drive is initialized for <i>3-Wire Initialization</i> [A1-03 = 3330].</p>	4 (0 - 1FF)	840
H1-07 (0404)	Terminal S7 Function Selection	<p>V/f CL-V/f OLV CLV AOLV OLV/PM AOLV/PM CLV/PM EZOLV</p> <p>Sets the function for MFDI terminal S7.</p> <p>Note: The default setting is <i>4</i> when the drive is initialized for <i>3-Wire Initialization</i> [A1-03 = 3330].</p>	6 (0 - 1FF)	840
H1-08 (0405)	Terminal S8 Function Selection	<p>V/f CL-V/f OLV CLV AOLV OLV/PM AOLV/PM CLV/PM EZOLV</p> <p>Sets the function for MFDI terminal S8.</p>	8 (0 - 1FF)	840
H1-21 (0B70)	Terminal S1 Function Selection 2	<p>V/f CL-V/f OLV CLV AOLV OLV/PM AOLV/PM CLV/PM EZOLV</p> <p>Sets the second function for MFDI terminal S1.</p>	F (1 - 19F)	840
H1-22 (0B71)	Terminal S2 Function Select 2	<p>V/f CL-V/f OLV CLV AOLV OLV/PM AOLV/PM CLV/PM EZOLV</p> <p>Sets the second function for MFDI terminal S2.</p>	F (1 - 19F)	840
H1-23 (0B72)	Terminal S3 Function Selection 2	<p>V/f CL-V/f OLV CLV AOLV OLV/PM AOLV/PM CLV/PM EZOLV</p> <p>Sets the second function for MFDI terminal S3.</p>	F (1 - 19F)	840
H1-24 (0B73)	Terminal S4 Function Selection 2	<p>V/f CL-V/f OLV CLV AOLV OLV/PM AOLV/PM CLV/PM EZOLV</p> <p>Sets the second function for MFDI terminal S4.</p>	F (1 - 19F)	841
H1-25 (0B74)	Terminal S5 Function Selection 2	<p>V/f CL-V/f OLV CLV AOLV OLV/PM AOLV/PM CLV/PM EZOLV</p> <p>Sets the second function for MFDI terminal S5.</p>	F (1 - 19F)	841
H1-26 (0B75)	Terminal S6 Function Selection 2	<p>V/f CL-V/f OLV CLV AOLV OLV/PM AOLV/PM CLV/PM EZOLV</p> <p>Sets the second function for MFDI terminal S6.</p>	F (1 - 19F)	841
H1-27 (0B76)	Terminal S7 Function Selection 2	<p>V/f CL-V/f OLV CLV AOLV OLV/PM AOLV/PM CLV/PM EZOLV</p> <p>Sets the second function for MFDI terminal S7.</p>	F (1 - 19F)	841
H1-28 (0B77)	Terminal S8 Function Selection 2	<p>V/f CL-V/f OLV CLV AOLV OLV/PM AOLV/PM CLV/PM EZOLV</p> <p>Sets the second function for MFDI terminal S8.</p>	F (1 - 19F)	841
H1-40 (0B54)	Mbus Reg 15C0h bit0 Input Func	<p>V/f CL-V/f OLV CLV AOLV OLV/PM AOLV/PM CLV/PM EZOLV</p> <p>Sets MFDI function to set to <i>bit 0</i> of the MEMOBUS register <i>15C0</i> (Hex.).</p>	F (1 - 19F)	841
H1-41 (0B55)	Mbus Reg 15C0h bit1 Input Func	<p>V/f CL-V/f OLV CLV AOLV OLV/PM AOLV/PM CLV/PM EZOLV</p> <p>Sets MFDI function to set to <i>bit 1</i> of the MEMOBUS register <i>15C0</i> (Hex.).</p>	F (1 - 19F)	842
H1-42 (0B56)	Mbus Reg 15C0h bit2 Input Func	<p>V/f CL-V/f OLV CLV AOLV OLV/PM AOLV/PM CLV/PM EZOLV</p> <p>Sets MFDI function to set to <i>bit 2</i> of the MEMOBUS register <i>15C0</i> (Hex.).</p>	F (1 - 19F)	842

■ H1-xx: Multi-Function Digital Input Setting Values

Setting Value	Function	Description	Ref.
0	3-Wire Sequence	V/f CL-V/f OLV CLV AOLV OLV/PM AOLV/PM CLV/PM EZOLV Sets the direction of motor rotation for 3-wire sequence.	842
1	LOCAL/REMOTE Selection	V/f CL-V/f OLV CLV AOLV OLV/PM AOLV/PM CLV/PM EZOLV Sets drive control for the keypad (LOCAL) or an external source (REMOTE). ON : LOCAL OFF : REMOTE	843
2	External Reference 1/2 Selection	V/f CL-V/f OLV CLV AOLV OLV/PM AOLV/PM CLV/PM EZOLV Sets the drive to use Run command source 1/2 or Reference command source 1/2 when in REMOTE Mode. ON : b1-15 [Frequency Reference Selection 2], b1-16 [Run Command Selection 2] OFF : b1-01 [Frequency Reference Selection 1], b1-02 [Run Command Selection 1]	843
3	Multi-Step Speed Reference 1	V/f CL-V/f OLV CLV AOLV OLV/PM AOLV/PM CLV/PM EZOLV Uses speed references d1-01 to d1-16 to set a multi-step speed reference.	843
4	Multi-Step Speed Reference 2	V/f CL-V/f OLV CLV AOLV OLV/PM AOLV/PM CLV/PM EZOLV Uses speed references d1-01 to d1-16 to set a multi-step speed reference.	843
5	Multi-Step Speed Reference 3	V/f CL-V/f OLV CLV AOLV OLV/PM AOLV/PM CLV/PM EZOLV Uses speed references d1-01 to d1-16 to set a multi-step speed reference.	844
6	Jog Reference Selection	V/f CL-V/f OLV CLV AOLV OLV/PM AOLV/PM CLV/PM EZOLV Sets the drive to use the JOG Frequency Reference (JOG command) set in d1-17. The JOG Frequency Reference (JOG command) overrides Frequency References 1 to 16 (d1-01 to d1-16).	844
7	Accel/Decel Time Selection 1	V/f CL-V/f OLV CLV AOLV OLV/PM AOLV/PM CLV/PM EZOLV Sets the drive to use C1-01 [Acceleration Time 1] and C1-02 [Deceleration Time 1] or C1-03 [Acceleration Time 2] and C1-04 [Deceleration Time 2].	844
8	Baseblock Command (N. O.)	V/f CL-V/f OLV CLV AOLV OLV/PM AOLV/PM CLV/PM EZOLV Sets the command that stops drive output and coasts the motor to stop when the input is ON. ON : Baseblock (drive output stop) OFF : Normal operation	844
9	Baseblock Command (N. C.)	V/f CL-V/f OLV CLV AOLV OLV/PM AOLV/PM CLV/PM EZOLV Sets the command that stops drive output and coasts the motor to stop when the input terminal is OFF. ON : Normal operation OFF : Baseblock (drive output stop)	844
A	Accel/Decel Ramp Hold	V/f CL-V/f OLV CLV AOLV OLV/PM AOLV/PM CLV/PM EZOLV Momentarily pauses motor acceleration and deceleration when the terminal is turned ON, retains the output frequency that was stored in the drive at the time of the pause, and restarts motor operation.	845
B	Overheat Alarm (oH2)	V/f CL-V/f OLV CLV AOLV OLV/PM AOLV/PM CLV/PM EZOLV Sets the drive to show an oH2 [External Overheat (H1-XX=B)] alarm when the input terminal is ON. The alarm does not have an effect on drive operation.	845
C	Analog Terminal Enable Selection	V/f CL-V/f OLV CLV AOLV OLV/PM AOLV/PM CLV/PM EZOLV Sets the command that enables or disables the terminals selected in H3-14 [Analog Input Terminal Enable Sel]. ON : Terminal selected with H3-14 is enabled OFF : Terminal selected with H3-14 is disabled	845
D	Ignore Speed Fdbk (V/f w/o Enc)	V/f CL-V/f OLV CLV AOLV OLV/PM AOLV/PM CLV/PM EZOLV Sets the command to disable speed feedback control and run the drive in V/f control or use speed feedback from the encoder. ON : Speed feedback control disable (V/f Control) OFF : Speed feedback control enable (Closed Loop V/f Control)	845
E	ASR Integral Reset	V/f CL-V/f OLV CLV AOLV OLV/PM AOLV/PM CLV/PM EZOLV Sets the command to reset the integral value and use PI control or P control for the speed control loop. ON : P control OFF : PI control	845
F	Not Used	V/f CL-V/f OLV CLV AOLV OLV/PM AOLV/PM CLV/PM EZOLV Use this setting for unused terminals or to use terminals in through mode.	845
10	Up Command	V/f CL-V/f OLV CLV AOLV OLV/PM AOLV/PM CLV/PM EZOLV Sets the command to use a push button switch to increase the drive frequency reference. You must also set Setting 11 [Down Command]. ON : Increases the frequency reference. OFF : Holds the current frequency reference.	846
11	Down Command	V/f CL-V/f OLV CLV AOLV OLV/PM AOLV/PM CLV/PM EZOLV Sets the command to use a push button switch to decrease the drive frequency reference. You must also set Setting 10 [Up Command]. ON : Decreases the frequency reference. OFF : Holds the current frequency reference.	847
12	Forward Jog	V/f CL-V/f OLV CLV AOLV OLV/PM AOLV/PM CLV/PM EZOLV Sets the command to operate the motor in the forward direction at the Jog Frequency set in d1-17 [Jog Reference].	848

11.10 H: Terminal Functions

Setting Value	Function	Description	Ref.
13	Reverse Jog	V/f CL-V/f OLV CLV AOLV OLV/PM AOLV/PM CLV/PM EZOLV Sets the command to operate the motor in the reverse direction at the Jog Frequency set in <i>d1-17 [Jog Reference]</i> .	848
14	Fault Reset	V/f CL-V/f OLV CLV AOLV OLV/PM AOLV/PM CLV/PM EZOLV Sets the command to reset the current fault when the Run command is inactive. Note: The drive ignores the fault reset command when the Run command is active. Remove the Run command before trying to reset a fault.	848
15	Fast Stop (N.O.)	V/f CL-V/f OLV CLV AOLV OLV/PM AOLV/PM CLV/PM EZOLV Sets the command to ramp to stop in the deceleration time set in <i>C1-09 [Fast Stop Time]</i> when the input terminal is ON while the drive is operating.	848
16	Motor 2 Selection	V/f CL-V/f OLV CLV AOLV OLV/PM AOLV/PM CLV/PM EZOLV Sets the command for the drive to operate motor 1 or motor 2. Stop the motors before switching. ON : Selects motor 2 OFF : Selects motor 1	849
17	Fast Stop (N.C.)	V/f CL-V/f OLV CLV AOLV OLV/PM AOLV/PM CLV/PM EZOLV Sets the command to ramp to stop in the deceleration time set in <i>C1-09 [Fast Stop Time]</i> when the input terminal is ON while the drive is operating.	849
18	Timer Function	V/f CL-V/f OLV CLV AOLV OLV/PM AOLV/PM CLV/PM EZOLV Sets the command to start the timer function. Use this setting with <i>Timer Output [H2-xx = 12]</i> .	850
19	PID Disable	V/f CL-V/f OLV CLV AOLV OLV/PM AOLV/PM CLV/PM EZOLV Sets the command to disable PID control when <i>b5-01 = 1 to 8 [PID Mode Setting = Enabled]</i> . ON : PID control disabled OFF : PID control enabled	850
1A	Accel/Decel Time Selection 2	V/f CL-V/f OLV CLV AOLV OLV/PM AOLV/PM CLV/PM EZOLV Set this function and <i>H1-xx = 7 [Accel/Decel Time Selection 1]</i> together. Sets the drive to use <i>C1-05 [Acceleration Time 3]</i> and <i>C1-06 [Deceleration Time 3]</i> or <i>C1-07 [Acceleration Time 4]</i> and <i>C1-08 [Deceleration Time 4]</i> .	850
1B	Programming Lockout	V/f CL-V/f OLV CLV AOLV OLV/PM AOLV/PM CLV/PM EZOLV Sets the command to prevent parameter changes when the terminal is OFF. ON : Programming Lockout OFF : Parameter Write Prohibit	850
1E	Reference Sample Hold	V/f CL-V/f OLV CLV AOLV OLV/PM AOLV/PM CLV/PM EZOLV Sets the command to sample the frequency reference at terminals A1, A2, or A3 and hold the frequency reference at that frequency.	851
20	External Fault (NO-Always-Ramp)	V/f CL-V/f OLV CLV AOLV OLV/PM AOLV/PM CLV/PM EZOLV When the terminal activates, the drive ramps to stop in the selected deceleration time. Fault relay output terminal MA-MC will turn ON, and MB-MC will turn OFF. The drive always detects external faults whether the drive is stopped or running.	851
21	External Fault (NC-Always-Ramp)	V/f CL-V/f OLV CLV AOLV OLV/PM AOLV/PM CLV/PM EZOLV When the terminal deactivates, the drive ramps to stop in the selected deceleration time. Fault relay output terminal MA-MC will turn ON, and MB-MC will turn OFF. The drive always detects external faults whether the drive is stopped or running.	851
22	External Fault (NO-@Run-Ramp)	V/f CL-V/f OLV CLV AOLV OLV/PM AOLV/PM CLV/PM EZOLV When the terminal activates during run, the drive ramps to stop in the selected deceleration time. Fault relay output terminal MA-MC will turn ON, and MB-MC will turn OFF. The drive does not detect external faults while the drive is stopped.	851
23	External Fault (NC-@Run-Ramp)	V/f CL-V/f OLV CLV AOLV OLV/PM AOLV/PM CLV/PM EZOLV When the terminal deactivates during run, the drive ramps to stop in the selected deceleration time. Fault relay output terminal MA-MC will turn ON, and MB-MC will turn OFF. The drive does not detect external faults while the drive is stopped.	851
24	External Fault (NO-Always-Coast)	V/f CL-V/f OLV CLV AOLV OLV/PM AOLV/PM CLV/PM EZOLV When the terminal activates, the drive shuts off the output and the motor coasts to stop. Fault relay output terminal MA-MC will turn ON, and MB-MC will turn OFF. The drive always detects external faults whether the drive is stopped or running.	851
25	External Fault (NC-Always-Coast)	V/f CL-V/f OLV CLV AOLV OLV/PM AOLV/PM CLV/PM EZOLV When the terminal deactivates, the drive shuts off the output and the motor coasts to stop. Fault relay output terminal MA-MC will turn ON, and MB-MC will turn OFF. The drive always detects external faults whether the drive is stopped or running.	851
26	External Fault (NO-@Run-Coast)	V/f CL-V/f OLV CLV AOLV OLV/PM AOLV/PM CLV/PM EZOLV When the terminal activates during run, the drive shuts off the output and the motor coasts to stop. Fault relay output terminal MA-MC will turn ON, and MB-MC will turn OFF. The drive does not detect external faults while the drive is stopped.	851
27	External Fault (NC-@Run-Coast)	V/f CL-V/f OLV CLV AOLV OLV/PM AOLV/PM CLV/PM EZOLV When the terminal deactivates during run, the drive shuts off the output and the motor coasts to stop. Fault relay output terminal MA-MC will turn ON, and MB-MC will turn OFF. The drive does not detect external faults while the drive is stopped.	851
28	External Fault (NO-Always-FStop)	V/f CL-V/f OLV CLV AOLV OLV/PM AOLV/PM CLV/PM EZOLV When the terminal activates, the drive stops the motor in the deceleration time set to <i>C1-09 [Fast Stop Time]</i> . Fault relay output terminal MA-MC turns ON, and MB-MC turns OFF. Stopped drives and running drives will detect external faults.	851

Setting Value	Function	Description	Ref.
29	External Fault (NC-Always-FStop)	V/f CL-V/f OLV CLV AOLV OLV/PM AOLV/PM CLV/PM EZOLV When the terminal deactivates, the drive stops the motor in the deceleration time set to <i>C1-09 [Fast Stop Time]</i> . Fault relay output terminal MA-MC turns ON, and MB-MC turns OFF. Stopped drives and running drives will detect external faults.	851
2A	External Fault (NO-@Run-FStop)	V/f CL-V/f OLV CLV AOLV OLV/PM AOLV/PM CLV/PM EZOLV When the terminal activates during run, the drive stops the motor in the deceleration time set to <i>C1-09 [Fast Stop Time]</i> . Fault relay output terminal MA-MC turns ON, and MB-MC turns OFF. Stopped drives will not detect external faults.	851
2B	External Fault (NC-@Run-FStop)	V/f CL-V/f OLV CLV AOLV OLV/PM AOLV/PM CLV/PM EZOLV When the terminal deactivates during run, the drive stops the motor in the deceleration time set to <i>C1-09 [Fast Stop Time]</i> . Fault relay output terminal MA-MC turns ON, and MB-MC turns OFF. Stopped drives will not detect external faults.	851
2C	External Fault (NO-Always-Alarm)	V/f CL-V/f OLV CLV AOLV OLV/PM AOLV/PM CLV/PM EZOLV When the terminal activates, the keypad shows <i>EFx [External Fault (Input Terminal Sx)]</i> and the output terminal set for Alarm [<i>H2-01 to H2-03 = 10</i>] activates. The drive continues operation. Stopped drives and running drives will detect external faults.	851
2D	External Fault (NC-Always-Alarm)	V/f CL-V/f OLV CLV AOLV OLV/PM AOLV/PM CLV/PM EZOLV When the terminal deactivates, the keypad shows <i>EFx [External Fault (Input Terminal Sx)]</i> and the output terminal set for Alarm [<i>H2-01 to H2-03 = 10</i>] activates. The drive continues operation. Stopped drives and running drives will detect external faults.	851
2E	External Fault (NO-@Run-Alarm)	V/f CL-V/f OLV CLV AOLV OLV/PM AOLV/PM CLV/PM EZOLV When the terminal activates during run, the keypad shows <i>EFx [External Fault (Input Terminal Sx)]</i> and the output terminal set for Alarm [<i>H2-01 to H2-03 = 10</i>] activates. The drive continues operation. Stopped drives will not detect external faults.	851
2F	External Fault (NC-@Run-Alarm)	V/f CL-V/f OLV CLV AOLV OLV/PM AOLV/PM CLV/PM EZOLV When the terminal deactivates during run, the keypad shows <i>EFx [External Fault (Input Terminal Sx)]</i> and the output terminal set for Alarm [<i>H2-01 to H2-03 = 10</i>] activates. The drive continues operation. Stopped drives will not detect external faults.	851
30	PID Integrator Reset	V/f CL-V/f OLV CLV AOLV OLV/PM AOLV/PM CLV/PM EZOLV Sets the command to reset and hold the PID control integral to 0 when the terminal is ON.	852
31	PID Integrator Hold	V/f CL-V/f OLV CLV AOLV OLV/PM AOLV/PM CLV/PM EZOLV Sets the command to hold the integral value of the PID control while the terminal is activated.	852
32	Multi-Step Speed Reference 4	V/f CL-V/f OLV CLV AOLV OLV/PM AOLV/PM CLV/PM EZOLV Uses speed references <i>d1-01 to d1-16</i> to set a multi-step speed reference.	852
34	PID Soft Starter Disable	V/f CL-V/f OLV CLV AOLV OLV/PM AOLV/PM CLV/PM EZOLV Sets the PID soft starter function. ON : Disable OFF : Enabled	852
35	PID Input (Error) Invert	V/f CL-V/f OLV CLV AOLV OLV/PM AOLV/PM CLV/PM EZOLV Sets the command to turn the terminal ON and OFF to switch the PID input level (polarity).	853
3E	PID Setpoint Selection 1	V/f CL-V/f OLV CLV AOLV OLV/PM AOLV/PM CLV/PM EZOLV Set this function and <i>H1-xx = 3F [PID Setpoint Selection 2]</i> together. Sets the function to switch the PID setpoint to <i>b5-58 to b5-60 [PID Setpoint 2 to 4]</i> .	853
3F	PID Setpoint Selection 2	V/f CL-V/f OLV CLV AOLV OLV/PM AOLV/PM CLV/PM EZOLV Set this function and <i>H1-xx = 3E [PID Setpoint Selection 1]</i> at the same time. Sets the function to switch the PID setpoint to <i>b5-58 to b5-60 [PID Setpoint 2 to 4]</i> .	853
40	Forward RUN (2-Wire)	V/f CL-V/f OLV CLV AOLV OLV/PM AOLV/PM CLV/PM EZOLV Sets the Forward Run command for 2-wire sequence 1. Set this function and <i>H1-xx = 41 [Reverse RUN (2-Wire)]</i> together. ON : Forward Run OFF : Stop Note: • If you turn ON the Forward Run command terminal and the Reverse Run command terminal, it will cause an <i>EF [FWD/REV Run Command Input Error]</i> alarm and the motor will ramp to stop. • Initialize the drive with a 2-wire sequence to set the Forward Run command to terminal S1. • This function will not operate at the same time as <i>H1-xx = 42, 43 [Run Command (2-Wire Sequence 2), FWD/REV (2-Wire Sequence 2)]</i> .	853
41	Reverse RUN (2-Wire)	V/f CL-V/f OLV CLV AOLV OLV/PM AOLV/PM CLV/PM EZOLV Sets the Forward Run command for 2-wire sequence 1. Set this function and <i>H1-xx = 40 [Forward RUN (2-Wire)]</i> together. ON : Reverse Run OFF : Stop Note: • If you turn ON the Forward Run command terminal and the Reverse Run command terminal, it will cause an <i>EF [FWD/REV Run Command Input Error]</i> alarm and the motor will ramp to stop. • Initialize the drive with a 2-wire sequence to set the Reverse Run command to terminal S2. • This function will not operate at the same time as <i>H1-xx = 42, 43 [Run Command (2-Wire Sequence 2), FWD/REV (2-Wire Sequence 2)]</i> .	853

11.10 H: Terminal Functions

Setting Value	Function	Description	Ref.
42	Run Command (2-Wire Sequence 2)	<p>V/f CL-V/f OLV CLV AOLV OLV/PM AOLV/PM CLV/PM EZOLV</p> <p>Sets the Run command for 2-wire sequence 2. Set this function and $H1-xx = 43$ [FWD/REV (2-Wire Sequence 2)] together. ON : Run OFF : Stop</p> <p>Note: This function will not operate at the same time as $H1-xx = 40, 41$ [Forward RUN (2-Wire), Reverse RUN (2-Wire)].</p>	854
43	FWD/REV (2-Wire Sequence 2)	<p>V/f CL-V/f OLV CLV AOLV OLV/PM AOLV/PM CLV/PM EZOLV</p> <p>Sets the direction of motor rotation for 2-wire sequence 2. Set this function and $H1-xx = 42$ [Run Command (2-Wire Sequence 2)] together. ON : Reverse Run OFF : Forward Run</p> <p>Note: • You must input the Run command to rotate the motor. • This function will not operate at the same time as $H1-xx = 40, 41$ [Forward RUN (2-Wire), Reverse RUN (2-Wire)].</p>	854
44	Add Offset Frequency 1 (d7-01)	<p>V/f CL-V/f OLV CLV AOLV OLV/PM AOLV/PM CLV/PM EZOLV</p> <p>Sets the function to add the offset frequency set in $d7-01$ [Offset Frequency 1] to the frequency reference when the terminal activates.</p>	854
45	Add Offset Frequency 2 (d7-02)	<p>V/f CL-V/f OLV CLV AOLV OLV/PM AOLV/PM CLV/PM EZOLV</p> <p>Sets the function to add the offset frequency set in $d7-02$ [Offset Frequency 2] to the frequency reference when the terminal activates.</p>	854
46	Add Offset Frequency 3 (d7-03)	<p>V/f CL-V/f OLV CLV AOLV OLV/PM AOLV/PM CLV/PM EZOLV</p> <p>Sets the function to add the offset frequency set in $d7-03$ [Offset Frequency 3] to the frequency reference when the terminal activates.</p>	854
47	Node Setup (CANopen)	<p>V/f CL-V/f OLV CLV AOLV OLV/PM AOLV/PM CLV/PM EZOLV</p> <p>Sets the function in CANopen communications to start the Node Setup function to set the drive node address from the host controller.</p>	854
60	DC Injection Braking Command	<p>V/f CL-V/f OLV CLV AOLV OLV/PM AOLV/PM CLV/PM EZOLV</p> <p>Sets the command to use DC Injection Braking to stop the motor.</p> <p>Note: When $A1-02 = 8$ [Control Method Selection = EZOLV], this function is available with a PM motor.</p>	855
61	Speed Search from Fmax	<p>V/f CL-V/f OLV CLV AOLV OLV/PM AOLV/PM CLV/PM EZOLV</p> <p>Sets the function to use an external reference to start speed search although $b3-01 = 0$ [Speed Search Selection at Start = Disabled] to not allow speed search at start.</p> <p>Note: The drive will detect $oPE03$ [Multi-Function Input Setting Err] when $H1-xx = 61$ [Speed Search from Fmax] and $H1-xx = 62$ [Speed Search from Fref] are set at the same time.</p>	855
62	Speed Search from Fref	<p>V/f CL-V/f OLV CLV AOLV OLV/PM AOLV/PM CLV/PM EZOLV</p> <p>Sets the function to use an external reference to start speed search although $b3-01 = 0$ [Speed Search Selection at Start = Disabled] to not allow speed search at start.</p> <p>Note: The drive will detect $oPE03$ [Multi-Function Input Setting Err] when $H1-xx = 61$ [Speed Search from Fmax] and $H1-xx = 62$ [Speed Search from Fref] are set at the same time.</p>	855
63	Field Weakening	<p>V/f CL-V/f OLV CLV AOLV OLV/PM AOLV/PM CLV/PM EZOLV</p> <p>Sets the function to send the Field Weakening Level and Field Weakening Frequency Limit commands set in $d6-01$ [Field Weakening Level] and $d6-02$ [Field Weakening Frequency Limit] when the input terminal is activated.</p>	855
65	KEB Ride-Thru 1 Activate (N.C.)	<p>V/f CL-V/f OLV CLV AOLV OLV/PM AOLV/PM CLV/PM EZOLV</p> <p>Sets operation of the KEB1 function through the KEB Ride-Thru 1 (N.C.). ON : Normal operation OFF : Deceleration during momentary power loss</p>	855
66	KEB Ride-Thru 1 Activate (N.O.)	<p>V/f CL-V/f OLV CLV AOLV OLV/PM AOLV/PM CLV/PM EZOLV</p> <p>Sets operation of the KEB1 function through the KEB Ride-Thru 1 (N.O.). ON : Deceleration during momentary power loss OFF : Normal operation</p>	856
67	Communications Test Mode	<p>V/f CL-V/f OLV CLV AOLV OLV/PM AOLV/PM CLV/PM EZOLV</p> <p>Set the function for the drive to self-test RS-485 serial communications operation.</p>	856
68	High Slip Braking (HSB) Activate	<p>V/f CL-V/f OLV CLV AOLV OLV/PM AOLV/PM CLV/PM EZOLV</p> <p>Sets the command to use high-slip braking to stop the motor.</p>	856
6 A	Drive Enable	<p>V/f CL-V/f OLV CLV AOLV OLV/PM AOLV/PM CLV/PM EZOLV</p> <p>Sets the function to show dnE [Drive Disabled] on the keypad and ignore Run commands when the terminal is OFF.</p>	856
71	Torque Control	<p>V/f CL-V/f OLV CLV AOLV OLV/PM AOLV/PM CLV/PM EZOLV</p> <p>Sets the function to switch between torque control and speed control. ON : Torque control OFF : Speed control</p>	856
72	Zero Servo	<p>V/f CL-V/f OLV CLV AOLV OLV/PM AOLV/PM CLV/PM EZOLV</p> <p>Sets the function to hold a stopped motor.</p>	857

Setting Value	Function	Description	Ref.
75	Up 2 Command	<p>V/f CL-V/f OLV CLV AOLV OLV/PM AOLV/PM CLV/PM EZOLV</p> <p>Sets the function to increase the frequency reference bias value to accelerate the motor when the terminal is activated. Set this function and $H1-xx = 76$ [Down 2 Command] together.</p> <p>Note: When you use this function, set the optimal bias limit values with $d4-08$ and $d4-09$ [Up/Down 2 Bias Upper Limit/Lower Limit].</p>	857
76	Down 2 Command	<p>V/f CL-V/f OLV CLV AOLV OLV/PM AOLV/PM CLV/PM EZOLV</p> <p>Sets the function to decrease the frequency reference bias value to decelerate the motor when the terminal is activated. Set this function and $H1-xx = 75$ [Up 2 Command] together.</p> <p>Note: When you use this function, set the optimal bias limit values with $d4-08$ and $d4-09$ [Up/Down 2 Bias Upper Limit/Lower Limit].</p>	858
77	ASR Gain (C5-03) Select	<p>V/f CL-V/f OLV CLV AOLV OLV/PM AOLV/PM CLV/PM EZOLV</p> <p>Sets the function to switch the ASR proportional gain to $C5-01$ [ASR Proportional Gain 1] or $C5-03$ [ASR Proportional Gain 2]. ON : C5-03 OFF : C5-01</p>	859
78	Analog TorqueRef Polarity Invert	<p>V/f CL-V/f OLV CLV AOLV OLV/PM AOLV/PM CLV/PM EZOLV</p> <p>Sets the rotation direction of the external torque reference. ON : External torque reference reverse direction OFF : External torque reference forward direction</p>	859
7A	KEB Ride-Thru 2 Activate (N.C.)	<p>V/f CL-V/f OLV CLV AOLV OLV/PM AOLV/PM CLV/PM EZOLV</p> <p>Sets operation of the KEB2 function through the KEB Ride-Thru 2 (N.C.). ON : Normal operation OFF : Deceleration during momentary power loss</p>	859
7B	KEB Ride-Thru 2 Activate (N.O.)	<p>V/f CL-V/f OLV CLV AOLV OLV/PM AOLV/PM CLV/PM EZOLV</p> <p>Sets operation of the KEB2 function through the KEB Ride-Thru 2 (N.O.). ON : Deceleration during momentary power loss OFF : Normal operation</p>	859
7C	Short Circuit Braking (N.O.)	<p>V/f CL-V/f OLV CLV AOLV OLV/PM AOLV/PM CLV/PM EZOLV</p> <p>Sets operation of Short Circuit Braking (N.O.). ON : Short Circuit Braking is enabled. OFF : Normal operation</p> <p>Note: When $A1-02 = 8$ [Control Method Selection = EZOLV], this function is available only when you use a PM motor.</p>	859
7D	Short Circuit Braking (N.C.)	<p>V/f CL-V/f OLV CLV AOLV OLV/PM AOLV/PM CLV/PM EZOLV</p> <p>Sets operation of Short Circuit Braking (N.C.). ON : Normal operation OFF : Short Circuit Braking is enabled.</p> <p>Note: When $A1-02 = 8$ [Control Method Selection = EZOLV], this function is available only when you use a PM motor.</p>	860
7E	Reverse Rotation Identifier	<p>V/f CL-V/f OLV CLV AOLV OLV/PM AOLV/PM CLV/PM EZOLV</p> <p>Sets the rotation direction of the motor when in Simple Closed Loop V/f Control method and $F1-21, F1-37 = 0$ [Encoder Option Function Selection = A pulse detection], or when in Closed Loop V/f Control method. ON : Reverse run OFF : Forward run</p>	860
7F	PID Bi-Directional Enable	<p>V/f CL-V/f OLV CLV AOLV OLV/PM AOLV/PM CLV/PM EZOLV</p> <p>Sets operation of the PID Bi-Directional function. ON : Enabled OFF : Disabled</p>	860
90	DWEZ Digital Input 1	<p>V/f CL-V/f OLV CLV AOLV OLV/PM AOLV/PM CLV/PM EZOLV</p> <p>Sets the DriveWorksEZ digital input 1. Refer to the DriveWorksEZ online manual for more information.</p>	860
91	DWEZ Digital Input 2	<p>V/f CL-V/f OLV CLV AOLV OLV/PM AOLV/PM CLV/PM EZOLV</p> <p>Sets the DriveWorksEZ digital input 2. Refer to the DriveWorksEZ online manual for more information.</p>	860
92	DWEZ Digital Input 3	<p>V/f CL-V/f OLV CLV AOLV OLV/PM AOLV/PM CLV/PM EZOLV</p> <p>Sets the DriveWorksEZ digital input 3. Refer to the DriveWorksEZ online manual for more information.</p>	860
93	DWEZ Digital Input 4	<p>V/f CL-V/f OLV CLV AOLV OLV/PM AOLV/PM CLV/PM EZOLV</p> <p>Sets the DriveWorksEZ digital input 4. Refer to the DriveWorksEZ online manual for more information.</p>	860
94	DWEZ Digital Input 5	<p>V/f CL-V/f OLV CLV AOLV OLV/PM AOLV/PM CLV/PM EZOLV</p> <p>Sets the DriveWorksEZ digital input 5. Refer to the DriveWorksEZ online manual for more information.</p>	860
95	DWEZ Digital Input 6	<p>V/f CL-V/f OLV CLV AOLV OLV/PM AOLV/PM CLV/PM EZOLV</p> <p>Sets the DriveWorksEZ digital input 6. Refer to the DriveWorksEZ online manual for more information.</p>	860
96	DWEZ Digital Input 7	<p>V/f CL-V/f OLV CLV AOLV OLV/PM AOLV/PM CLV/PM EZOLV</p> <p>Sets the DriveWorksEZ digital input 7. Refer to the DriveWorksEZ online manual for more information.</p>	860

11.10 H: Terminal Functions

Setting Value	Function	Description	Ref.
97	DWEZ Digital Input 8	V/f CL-V/f OLV CLV AOLV OLV/PM AOLV/PM CLV/PM EZOLV Sets the DriveWorksEZ digital input 8. Refer to the DriveWorksEZ online manual for more information.	860
9F	DWEZ Disable	V/f CL-V/f OLV CLV AOLV OLV/PM AOLV/PM CLV/PM EZOLV Sets operation of the DriveWorksEZ program saved in the drive. ON : Disabled OFF : Enabled Note: Set $A1-07 = 2$ [DriveWorksEZ Function Selection = Enabled/Disabled wDigital Input] to use this function.	860
101	!LOCAL/REMOTE Selection	V/f CL-V/f OLV CLV AOLV OLV/PM AOLV/PM CLV/PM EZOLV Sets drive control for the keypad (LOCAL) or an external source (REMOTE). ON : REMOTE OFF : LOCAL	861
102	!External Reference 1/2 Selection	V/f CL-V/f OLV CLV AOLV OLV/PM AOLV/PM CLV/PM EZOLV Sets the drive to use Run command source 1/2 or Reference command source 1/2 when in REMOTE Mode. ON : $b1-01 =$ [Frequency Reference Selection 1], $b1-02$ [Run Command Selection 1] OFF : $b1-15 =$ [Frequency Reference Selection 2], $b1-16$ [Run Command Selection 2]	861
103	!Multi-Step Speed Reference 1	V/f CL-V/f OLV CLV AOLV OLV/PM AOLV/PM CLV/PM EZOLV Uses a combination of multi-step speed references 1, 2 and 3 (N.C.) to set $d1-01$ to $d1-08$ [Multi-Step Speed Reference].	861
104	!Multi-Step Speed Reference 2	V/f CL-V/f OLV CLV AOLV OLV/PM AOLV/PM CLV/PM EZOLV Uses a combination of multi-step speed references 1, 2 and 3 (N.C.) to set $d1-01$ to $d1-08$ [Multi-Step Speed Reference].	861
105	!Multi-Step Speed Reference 3	V/f CL-V/f OLV CLV AOLV OLV/PM AOLV/PM CLV/PM EZOLV Uses a combination of multi-step speed references 1, 2 and 3 (N.C.) to set $d1-01$ to $d1-08$ [Multi-Step Speed Reference].	861
106	!Jog Reference Selection	V/f CL-V/f OLV CLV AOLV OLV/PM AOLV/PM CLV/PM EZOLV Sets the drive to use the JOG Frequency Reference (JOG command) set in $d1-17$ [Jog Reference]. The JOG Frequency Reference (JOG command) overrides the $d1-01$ to $d1-16$ [References 1 to 16].	861
107	!Accel/Decel Time Selection 1	V/f CL-V/f OLV CLV AOLV OLV/PM AOLV/PM CLV/PM EZOLV Sets the drive to use $C1-01$, $C1-02$ [Acceleration/Deceleration Time 1] or $C1-03$, $C1-04$ [Acceleration/Deceleration Time 2].	861
10 A	!Accel/Decel Ramp Hold	V/f CL-V/f OLV CLV AOLV OLV/PM AOLV/PM CLV/PM EZOLV Momentarily pauses motor acceleration and deceleration when the terminal deactivates, retains the output frequency that was stored in the drive at the time of the pause, and restarts motor operation.	861
10B	!Overheat Alarm (oH2)	V/f CL-V/f OLV CLV AOLV OLV/PM AOLV/PM CLV/PM EZOLV Sets the drive to display an $oH2$ [Drive Overheat Warning] alarm when the input terminal deactivates. The alarm does not have an effect on drive operation.	861
10C	!Analog Terminal Enable Selection	V/f CL-V/f OLV CLV AOLV OLV/PM AOLV/PM CLV/PM EZOLV Enables and disables the terminal selected with the $H3-14$ [Analog Input Term Enable Select] function. ON : Input to the terminal selected with $H3-14$ is disabled OFF : Input to the terminal selected with $H3-14$ is enabled	861
10D	!Ignore Speed Fdbk (V/f w/o Enc)	V/f CL-V/f OLV CLV AOLV OLV/PM AOLV/PM CLV/PM EZOLV When the terminal deactivates, the drive ignores the feedback control from the encoder and operates in V/f control. When the terminal activates, the drive uses the feedback from the encoder to control the motor speed again. ON : Speed feedback control enable (Closed Loop V/f Control) OFF : Speed feedback control disable (V/f Control)	861
10E	!ASR Integral Reset	V/f CL-V/f OLV CLV AOLV OLV/PM AOLV/PM CLV/PM EZOLV Sets the command to reset the integral value and use PI control or P control for the speed control loop. ON : PI control OFF : P control	861
110	!Up Command	V/f CL-V/f OLV CLV AOLV OLV/PM AOLV/PM CLV/PM EZOLV Set this function and 111 [!Down Command] together. Sets the Up command and Down command to use the two push button switches to increase and decrease the drive frequency reference. ON : Holds the current frequency reference. OFF : Increases the frequency reference.	861
111	!Down Command	V/f CL-V/f OLV CLV AOLV OLV/PM AOLV/PM CLV/PM EZOLV Set this function and 110 [!Up Command] together. Sets the Up command and Down command to use the two push button switches to increase and decrease the drive frequency reference. ON : Holds the current frequency reference. OFF : Decreases the frequency reference.	861
114	!Fault Reset	V/f CL-V/f OLV CLV AOLV OLV/PM AOLV/PM CLV/PM EZOLV Sets the command to reset the current fault when the Run command is not active. Note: The drive ignores the fault reset command when the Run command is active. Remove the Run command before you try to reset a fault.	861

Setting Value	Function	Description	Ref.
116	!Motor 2 Selection	V/f CL-V/f OLV CLV AOLV OLV/PM AOLV/PM CLV/PM EZOLV Switches between motor 1 or motor 2. Switch the motor while the motor is stopped. ON : Selects motor 1 OFF : Selects motor 2	861
118	!Timer Function	V/f CL-V/f OLV CLV AOLV OLV/PM AOLV/PM CLV/PM EZOLV Sets the command to start the timer function. Use this setting with $H2-xx = 112$ [!Timer Output].	861
119	!PID Disable	V/f CL-V/f OLV CLV AOLV OLV/PM AOLV/PM CLV/PM EZOLV Sets the command to disable PID control with an external input when $b5-01 = 1$ to 8 [PID Function Setting = Enabled]. ON : PID control enabled OFF : PID control disabled	861
11 A	!Accel/Decel Time Selection 2	V/f CL-V/f OLV CLV AOLV OLV/PM AOLV/PM CLV/PM EZOLV Set this function and $H1-xx = 107$ [!Accel/Decel Time Selection 1] together. Sets the drive to use $C1-01$ to $C1-08$ [Acceleration/Deceleration Times 1 to 4].	861
11B	!Programming Lockout	V/f CL-V/f OLV CLV AOLV OLV/PM AOLV/PM CLV/PM EZOLV Sets the command to prevent parameter changes when the terminal is OFF. You can continue to view parameter setting values when the terminal is ON [Parameter Write Prohibit]. ON : Parameter Write Prohibit OFF : Programming Lockout	861
11E	!Reference Sample Hold	V/f CL-V/f OLV CLV AOLV OLV/PM AOLV/PM CLV/PM EZOLV Samples the analog frequency reference input to the terminals A1, A2, or A3, and continues operation at the sampled frequency.	861
130	!PID Integrator Reset	V/f CL-V/f OLV CLV AOLV OLV/PM AOLV/PM CLV/PM EZOLV Sets the command to reset and hold the PID control integral to 0 when the terminal deactivates.	861
131	!PID Integrator Hold	V/f CL-V/f OLV CLV AOLV OLV/PM AOLV/PM CLV/PM EZOLV Sets the command to hold the integral value of the PID control while the terminal deactivates.	861
132	!Multi-Step Speed Reference 4	V/f CL-V/f OLV CLV AOLV OLV/PM AOLV/PM CLV/PM EZOLV Uses a combination of multi-step speed references 1, 2 and 3 (N.C.) to switch $d1-09$ to $d1-16$ [Reference 9 to 16].	861
134	!PID Soft Starter Disable	V/f CL-V/f OLV CLV AOLV OLV/PM AOLV/PM CLV/PM EZOLV Sets the PID soft starter function. ON : Enabled OFF : Disable	861
135	!PID Input (Error) Invert	V/f CL-V/f OLV CLV AOLV OLV/PM AOLV/PM CLV/PM EZOLV Sets the command to turn the terminal ON and OFF to switch the PID input level (polarity).	861
13E	!PID Setpoint Selection 1	V/f CL-V/f OLV CLV AOLV OLV/PM AOLV/PM CLV/PM EZOLV Set this function and $H1-xx = 13F$ [!PID Setpoint Selection 2] together. Sets the function to use the PID setpoint set in $b5-58$ to $b5-60$ [PID setpoint2 to 4].	861
13F	!PID Setpoint Selection 2	V/f CL-V/f OLV CLV AOLV OLV/PM AOLV/PM CLV/PM EZOLV Set this function and $H1-xx = 13E$ [!PID Setpoint Selection 1] together. Sets the function to use the PID setpoint set in $b5-58$ to $b5-60$ [PID setpoint2 to 4].	861
144	!Add Offset Frequency 1 (d7-01)	V/f CL-V/f OLV CLV AOLV OLV/PM AOLV/PM CLV/PM EZOLV Sets the function to add the offset frequency set in $d7-01$ to the frequency reference when the terminal deactivates.	861
145	!Add Offset Frequency 2 (d7-02)	V/f CL-V/f OLV CLV AOLV OLV/PM AOLV/PM CLV/PM EZOLV Sets the function to add the offset frequency set in $d7-02$ to the frequency reference when the terminal deactivates.	861
146	!Add Offset Frequency 3 (d7-03)	V/f CL-V/f OLV CLV AOLV OLV/PM AOLV/PM CLV/PM EZOLV Sets the function to add the offset frequency set in $d7-03$ to the frequency reference when the terminal deactivates.	861
147	!Node Setup (CANopen)	V/f CL-V/f OLV CLV AOLV OLV/PM AOLV/PM CLV/PM EZOLV Sets the function in CANopen communications to start the Node Setup function to set the drive node address from the host controller.	861
160	!DC Injection Braking Command	V/f CL-V/f OLV CLV AOLV OLV/PM AOLV/PM CLV/PM EZOLV Sets the command to use DC Injection Braking to stop the motor. Note: When $A1-02 = 8$ [Control Method Selection = EZ Vector Control], this function is available if you use a PM motor.	861
161	!Speed Search from Fmax	V/f CL-V/f OLV CLV AOLV OLV/PM AOLV/PM CLV/PM EZOLV Sets the function to use an external reference to start speed search although $b3-01 = 0$ [Speed Search Selection at Start = Disabled] to not allow speed search at start. Note: The drive will detect $oPE03$ [Multi-Function Input Setting Err] when $H1-xx = 161$ [!Speed Search from Fmax] and $H1-xx = 162$ [!Speed Search from Fref] are set at the same time.	861
162	!Speed Search from Fref	V/f CL-V/f OLV CLV AOLV OLV/PM AOLV/PM CLV/PM EZOLV Sets the function to use an external reference to start speed search although $b3-01 = 0$ [Speed Search Selection at Start = Disabled] to not allow speed search at start. Note: The drive will detect $oPE03$ [Multi-Function Input Setting Err] when $H1-xx = 161$ [!Speed Search from Fmax] and $H1-xx = 162$ [!Speed Search from Fref] are set at the same time.	861

11.10 H: Terminal Functions

Setting Value	Function	Description	Ref.
163	!Field Weakening	<input type="checkbox"/> V/f <input type="checkbox"/> CL-V/f <input type="checkbox"/> OLV <input type="checkbox"/> CLV <input type="checkbox"/> AOLV <input type="checkbox"/> OLV/PM <input type="checkbox"/> AOLV/PM <input type="checkbox"/> CLV/PM <input type="checkbox"/> EZOLV Sets the function to send the Field Weakening Level and Field Weakening Frequency Limit commands set in <i>d6-01</i> and <i>d6-02</i> when the input terminal deactivates.	861
167	!Communications Test Mode	<input type="checkbox"/> V/f <input type="checkbox"/> CL-V/f <input type="checkbox"/> OLV <input type="checkbox"/> CLV <input type="checkbox"/> AOLV <input type="checkbox"/> OLV/PM <input type="checkbox"/> AOLV/PM <input type="checkbox"/> CLV/PM <input type="checkbox"/> EZOLV Set the function for the drive to self-test RS-485 serial communications operation.	861
168	!High Slip Braking (HSB) Activate	<input type="checkbox"/> V/f <input type="checkbox"/> CL-V/f <input type="checkbox"/> OLV <input type="checkbox"/> CLV <input type="checkbox"/> AOLV <input type="checkbox"/> OLV/PM <input type="checkbox"/> AOLV/PM <input type="checkbox"/> CLV/PM <input type="checkbox"/> EZOLV Sets the command to use high-slip braking to stop the motor.	861
16 A	!Drive Enable	<input type="checkbox"/> V/f <input type="checkbox"/> CL-V/f <input type="checkbox"/> OLV <input type="checkbox"/> CLV <input type="checkbox"/> AOLV <input type="checkbox"/> OLV/PM <input type="checkbox"/> AOLV/PM <input type="checkbox"/> CLV/PM <input type="checkbox"/> EZOLV Sets the function to show <i>dnE [Drive Enabled]</i> on the keypad and ignore Run commands when the terminal activates.	861
171	!Torque Control	<input type="checkbox"/> V/f <input type="checkbox"/> CL-V/f <input type="checkbox"/> OLV <input type="checkbox"/> CLV <input type="checkbox"/> AOLV <input type="checkbox"/> OLV/PM <input type="checkbox"/> AOLV/PM <input type="checkbox"/> CLV/PM <input type="checkbox"/> EZOLV Switches between the speed control and the torque control. ON : Speed Control OFF : Torque Control	861
172	!Zero Servo	<input type="checkbox"/> V/f <input type="checkbox"/> CL-V/f <input type="checkbox"/> OLV <input type="checkbox"/> CLV <input type="checkbox"/> AOLV <input type="checkbox"/> OLV/PM <input type="checkbox"/> AOLV/PM <input type="checkbox"/> CLV/PM <input type="checkbox"/> EZOLV Holds a stopped motor.	861
175	!Up 2 Command	<input type="checkbox"/> V/f <input type="checkbox"/> CL-V/f <input type="checkbox"/> OLV <input type="checkbox"/> CLV <input type="checkbox"/> AOLV <input type="checkbox"/> OLV/PM <input type="checkbox"/> AOLV/PM <input type="checkbox"/> CLV/PM <input type="checkbox"/> EZOLV When the terminal deactivates, the motor accelerates by increasing the frequency reference bias value. Set !Up 2 Command and !Down 2 Command together. Note: When you use the functions, set the optimal bias limit values with <i>d4-08</i> and <i>d4-09 [Up/Down 2 Bias Upper Limit/Lower Limit (Up/Down 2)]</i> .	861
176	!Down 2 Command	<input type="checkbox"/> V/f <input type="checkbox"/> CL-V/f <input type="checkbox"/> OLV <input type="checkbox"/> CLV <input type="checkbox"/> AOLV <input type="checkbox"/> OLV/PM <input type="checkbox"/> AOLV/PM <input type="checkbox"/> CLV/PM <input type="checkbox"/> EZOLV When the terminal deactivates, the motor decelerates by decreasing the frequency reference bias value. Set !Up 2 Command and !Down 2 Command together. Note: When you use the functions, set the optimal bias limit values with <i>d4-08</i> and <i>d4-09 [Up/Down 2 Bias Upper Limit/Lower Limit (Up/Down 2)]</i> .	861
177	!ASR Gain (C5-03) Select	<input type="checkbox"/> V/f <input type="checkbox"/> CL-V/f <input type="checkbox"/> OLV <input type="checkbox"/> CLV <input type="checkbox"/> AOLV <input type="checkbox"/> OLV/PM <input type="checkbox"/> AOLV/PM <input type="checkbox"/> CLV/PM <input type="checkbox"/> EZOLV Sets the function to switch the ASR proportional gain to <i>C5-01 [ASR Proportional Gain 1]</i> or <i>C5-03 [ASR Proportional Gain 2]</i> . ON : C5-01 OFF : C5-03	861
178	!Analog TorqueRef Polarity Invert	<input type="checkbox"/> V/f <input type="checkbox"/> CL-V/f <input type="checkbox"/> OLV <input type="checkbox"/> CLV <input type="checkbox"/> AOLV <input type="checkbox"/> OLV/PM <input type="checkbox"/> AOLV/PM <input type="checkbox"/> CLV/PM <input type="checkbox"/> EZOLV Switches the rotation direction of the external torque reference. ON : External torque reference forward direction OFF : External torque reference reverse direction	861
17E	!Reverse Rotation Identifier	<input type="checkbox"/> V/f <input type="checkbox"/> CL-V/f <input type="checkbox"/> OLV <input type="checkbox"/> CLV <input type="checkbox"/> AOLV <input type="checkbox"/> OLV/PM <input type="checkbox"/> AOLV/PM <input type="checkbox"/> CLV/PM <input type="checkbox"/> EZOLV Lets you set the rotation direction of the motor when <i>F1-21, F1-37 = 0 [Encoder Option Function Selection = A pulse detection]</i> for Simple Closed Loop V/f Control method and Closed Loop V/f Control method. ON : Forward run OFF : Reverse run	861
17F	!PID Bi-Directional Enable	<input type="checkbox"/> V/f <input type="checkbox"/> CL-V/f <input type="checkbox"/> OLV <input type="checkbox"/> CLV <input type="checkbox"/> AOLV <input type="checkbox"/> OLV/PM <input type="checkbox"/> AOLV/PM <input type="checkbox"/> CLV/PM <input type="checkbox"/> EZOLV Switches the PID Bi-Directional output to enable or disable. ON : Disable OFF : Enabled	861
19F	!DWEZ Disable	<input type="checkbox"/> V/f <input type="checkbox"/> CL-V/f <input type="checkbox"/> OLV <input type="checkbox"/> CLV <input type="checkbox"/> AOLV <input type="checkbox"/> OLV/PM <input type="checkbox"/> AOLV/PM <input type="checkbox"/> CLV/PM <input type="checkbox"/> EZOLV Switches the DriveWorksEZ program saved in the drive to enable or disable. ON : Enabled OFF : Disable Note: Set <i>A1-07 = 2 [DriveWorksEZ Function Selection = Digital input]</i> to use this function.	861

◆ H2: Multi-function Digital Output

No. (Hex.)	Name	Description	Default (Range)	Ref.
H2-01 (040B)	Term M1-M2 Function Selection	<input type="checkbox"/> V/f <input type="checkbox"/> CL-V/f <input type="checkbox"/> OLV <input type="checkbox"/> CLV <input type="checkbox"/> AOLV <input type="checkbox"/> OLV/PM <input type="checkbox"/> AOLV/PM <input type="checkbox"/> CLV/PM <input type="checkbox"/> EZOLV Sets the function for MFDO terminal M1-M2. Note: When you do not use the terminal or when you use the terminal in through mode, set this parameter to <i>F</i> .	0 (0 - 1FF)	863
H2-02 (040C)	Term M3-M4 Function Selection	<input type="checkbox"/> V/f <input type="checkbox"/> CL-V/f <input type="checkbox"/> OLV <input type="checkbox"/> CLV <input type="checkbox"/> AOLV <input type="checkbox"/> OLV/PM <input type="checkbox"/> AOLV/PM <input type="checkbox"/> CLV/PM <input type="checkbox"/> EZOLV Sets the function for MFDO terminal M3-M4. Note: When you do not use the terminal or when you use the terminal in through mode, set this parameter to <i>F</i> .	1 (0 - 1FF)	863

No. (Hex.)	Name	Description	Default (Range)	Ref.
H2-03 (040D)	Term M5-M6 Function Selection	V/f CL-V/f OLV CLV AOLV OLV/PM AOLV/PM CLV/PM EZOLV Sets the function for MFDO terminal M5-M6. Note: When you do not use the terminal or when you use the terminal in through mode, set this parameter to <i>F</i> .	2 (0 - 1FF)	863
H2-06 (0437)	Watt Hour Output Unit Selection	V/f CL-V/f OLV CLV AOLV OLV/PM AOLV/PM CLV/PM EZOLV Sets the unit for the output signal when H2-01 to H2-03 = 39 [MFDO Function Selection = Watt Hour Pulse Output]. 0 : 0.1 kWh units 1 : 1 kWh units 2 : 10 kWh units 3 : 100 kWh units 4 : 1000 kWh units	0 (0 - 4)	863
H2-07 (0B3A)	Modbus Register 1 Address Select	V/f CL-V/f OLV CLV AOLV OLV/PM AOLV/PM CLV/PM EZOLV Sets the address of the MEMOBUS/Modbus register output to the MFDO terminal.	0001 (0001 - 1FFF)	864
H2-08 (0B3B)	Modbus Register 1 Bit Select	V/f CL-V/f OLV CLV AOLV OLV/PM AOLV/PM CLV/PM EZOLV Sets the bit of the MEMOBUS/Modbus register output to the MFDO terminal.	0000 (0000 - FFFF)	864
H2-09 (0B3C)	Modbus Register 2 Address Select	V/f CL-V/f OLV CLV AOLV OLV/PM AOLV/PM CLV/PM EZOLV Sets the address of the MEMOBUS/Modbus register output to the MFDO terminal.	0001 (0001 - 1FFF)	864
H2-10 (0B3D)	Modbus Register 2 Bit Select	V/f CL-V/f OLV CLV AOLV OLV/PM AOLV/PM CLV/PM EZOLV Sets the bit of the MEMOBUS/Modbus register output to the MFDO terminal.	0000 (0000 - FFFF)	864
H2-20 (1540)	Comparator 1 Monitor Selection	V/f CL-V/f OLV CLV AOLV OLV/PM AOLV/PM CLV/PM EZOLV Sets the monitor number (<i>Ux-xx</i>) for comparator 1. Note: Set the <i>x-xx</i> part of the <i>Ux-xx</i> [Monitor]. For example, set H2-20 = 102 to monitor U1-02 [Output Frequency]. When the <i>x</i> part of <i>Ux</i> is a letter, replace the letter (hexadecimal number) with a decimal number. For example, set H2-20 = 1301 to monitor Ud-01.	102 (000 - 9999)	865
H2-21 (1541)	Comparator 1 Lower Limit	V/f CL-V/f OLV CLV AOLV OLV/PM AOLV/PM CLV/PM EZOLV Sets the lower limit detection level for comparator 1 when the full scale analog output for the monitor selected in H2-20 [Comparator 1 Monitor Selection] is the 100% value.	0.0% (0.0 - 300.0%)	865
H2-22 (1542)	Comparator 1 Upper Limit	V/f CL-V/f OLV CLV AOLV OLV/PM AOLV/PM CLV/PM EZOLV Sets the upper limit detection level for comparator 1 when the full scale analog output for the monitor selected in H2-20 [Comparator 1 Monitor Selection] is the 100% value.	0.0% (0.0 - 300.0%)	865
H2-23 (1543)	Comparator 1 Hysteresis	V/f CL-V/f OLV CLV AOLV OLV/PM AOLV/PM CLV/PM EZOLV Sets the hysteresis level for comparator 1 as a percentage of the full scale analog output for the monitor selected in H2-20 [Comparator 1 Monitor Selection].	0.0% (0.0 - 10.0%)	865
H2-24 (1544)	Comparator 1 On-Delay Time	V/f CL-V/f OLV CLV AOLV OLV/PM AOLV/PM CLV/PM EZOLV Sets the on-delay time for comparator 1.	0.0 s (0.0 - 600.0 s)	865
H2-25 (1545)	Comparator 1 Off-Delay Time	V/f CL-V/f OLV CLV AOLV OLV/PM AOLV/PM CLV/PM EZOLV Sets the off-delay time for comparator 1.	0.0 s (0.0 - 600.0 s)	865
H2-26 (1546)	Comparator 2 Monitor Selection	V/f CL-V/f OLV CLV AOLV OLV/PM AOLV/PM CLV/PM EZOLV Sets the monitor number (<i>Ux-xx</i>) for comparator 2. Note: Set the <i>x-xx</i> part of the <i>Ux-xx</i> [Monitor]. For example, set H2-26 = 103 to monitor U1-03 [Output Current]. When the <i>x</i> part of <i>Ux</i> is a letter, replace the letter (hexadecimal number) with a decimal number. For example, set H2-26 = 1301 to monitor Ud-01.	103 (000 - 9999)	866
H2-27 (1547)	Comparator 2 Lower Limit	V/f CL-V/f OLV CLV AOLV OLV/PM AOLV/PM CLV/PM EZOLV Sets the lower limit detection level for comparator 2 as a percentage of the full scale analog output for the monitor selected in H2-26 [Comparator 2 Monitor Selection].	0.0% (0.0 - 300.0%)	866
H2-28 (1548)	Comparator 2 Upper Limit	V/f CL-V/f OLV CLV AOLV OLV/PM AOLV/PM CLV/PM EZOLV Sets the upper limit detection level for comparator 2 as a percentage of the full scale analog output for the monitor selected in H2-26 [Comparator 2 Monitor Selection].	0.0% (0.0 - 300.0%)	866
H2-29 (1549)	Comparator 2 Hysteresis	V/f CL-V/f OLV CLV AOLV OLV/PM AOLV/PM CLV/PM EZOLV Sets the hysteresis level for comparator 2 as a percentage of the full scale analog output for the monitor selected in H2-26 [Comparator 2 Monitor Selection].	0.0% (0.0 - 10.0%)	866
H2-30 (154A)	Comparator 2 On-Delay Time	V/f CL-V/f OLV CLV AOLV OLV/PM AOLV/PM CLV/PM EZOLV Sets the on-delay time for comparator 2.	0.0 s (0.0 - 600.0 s)	866
H2-31 (154B)	Comparator 2 Off-Delay Time	V/f CL-V/f OLV CLV AOLV OLV/PM AOLV/PM CLV/PM EZOLV Sets the off-delay time for comparator 2.	0.0 s (0.0 - 600.0 s)	866
H2-32 (159A)	Comparator 1 Filter Time	V/f CL-V/f OLV CLV AOLV OLV/PM AOLV/PM CLV/PM EZOLV Sets the time constant that is applied to the primary delay filter used for the analog output of the monitor selected with H2-20 [Comparator 1 Monitor Selection].	0.0s (0.0 - 10.0 s)	867

11.10 H: Terminal Functions

No. (Hex.)	Name	Description	Default (Range)	Ref.
H2-33 (159B)	Comparator1 Protection Selection	<p>V/f CL-V/f OLV CLV AOLV OLV/PM AOLV/PM CLV/PM EZOLV</p> <p>Sets drive operation when it detects CP1 [Comparator1 Limit Fault]. 0 : Ramp to Stop 1 : Coast to Stop 2 : Fast Stop (Use C1-09) 3 : Alarm Only 4 : Digital Output Only</p>	4 (0 - 4)	867
H2-34 (159C)	Comparator 2 Filter Time	<p>V/f CL-V/f OLV CLV AOLV OLV/PM AOLV/PM CLV/PM EZOLV</p> <p>Sets the time constant that is applied to the primary delay filter used for the analog output of the monitor selected with H2-26 [Comparator 2 Monitor Selection].</p>	0.0s (0.0 - 10.0 s)	867
H2-35 (159D)	Comparator2 Protection Selection	<p>V/f CL-V/f OLV CLV AOLV OLV/PM AOLV/PM CLV/PM EZOLV</p> <p>Sets drive operation when it detects CP2 [Comparator2 Limit Fault]. 0 : Ramp to Stop 1 : Coast to Stop 2 : Fast Stop (Use C1-09) 3 : Alarm Only 4 : Digital Output Only</p>	4 (0 - 4)	867
H2-36 (159E)	Comparator 1 Ineffective Time	<p>V/f CL-V/f OLV CLV AOLV OLV/PM AOLV/PM CLV/PM EZOLV</p> <p>Sets the length of time that CP1 [Comparator1 Limit Fault] is disabled.</p>	0.0 s (0.0 - 1000.0 s)	868
H2-37 (159F)	Comparator 2 Ineffective Time	<p>V/f CL-V/f OLV CLV AOLV OLV/PM AOLV/PM CLV/PM EZOLV</p> <p>Sets the length of time that CP2 [Comparator2 Limit Fault] is disabled.</p>	0.0 s (0.0 - 1000.0 s)	868
H2-40 (0B58)	Mbus Reg 15E0h bit0 Output Func	<p>V/f CL-V/f OLV CLV AOLV OLV/PM AOLV/PM CLV/PM EZOLV</p> <p>Sets the MFDO for bit 0 of MEMOBUS register 15E0 (Hex.).</p>	F (0 - 1FF)	868
H2-41 (0B59)	Mbus Reg 15E0h bit1 Output Func	<p>V/f CL-V/f OLV CLV AOLV OLV/PM AOLV/PM CLV/PM EZOLV</p> <p>Sets the MFDO for bit 1 of MEMOBUS register 15E0 (Hex.).</p>	F (0 - 1FF)	868
H2-42 (0B5A)	Mbus Reg 15E0h bit2 Output Func	<p>V/f CL-V/f OLV CLV AOLV OLV/PM AOLV/PM CLV/PM EZOLV</p> <p>Sets the MFDO for bit 2 of MEMOBUS register 15E0 (Hex.).</p>	F (0 - 1FF)	868
H2-60 (1B46) Expert	Term M1-M2 Secondary Function	<p>V/f CL-V/f OLV CLV AOLV OLV/PM AOLV/PM CLV/PM EZOLV</p> <p>Sets the second function for terminal M1-M2. Outputs the logical calculation results of the terminals assigned to functions by H2-01 [Term M1-M2 Function Selection].</p>	F (0 - FF)	868
H2-61 (1B47) Expert	Terminal M1-M2 Logical Operation	<p>V/f CL-V/f OLV CLV AOLV OLV/PM AOLV/PM CLV/PM EZOLV</p> <p>Sets the logical operation for the functions set in H2-01 [Term M1-M2 Function Selection] and H2-60 [Term M1-M2 Secondary Function].</p>	0 (0 - 8)	868
H2-62 (1B48) Expert	Terminal M1-M2 Delay Time	<p>V/f CL-V/f OLV CLV AOLV OLV/PM AOLV/PM CLV/PM EZOLV</p> <p>Sets the minimum on time used to output the logical calculation results from terminal M1-M2.</p>	0.1 s (0.0 - 25.0 s)	869
H2-63 (1B49) Expert	Term M3-M4 Secondary Function	<p>V/f CL-V/f OLV CLV AOLV OLV/PM AOLV/PM CLV/PM EZOLV</p> <p>Sets the second function for terminal M3-M4. Outputs the logical calculation results of the terminals assigned to functions by H2-02 [Term M3-M4 Function Selection].</p>	F (0 - FF)	869
H2-64 (1B4A) Expert	Terminal M3-M4 Logical Operation	<p>V/f CL-V/f OLV CLV AOLV OLV/PM AOLV/PM CLV/PM EZOLV</p> <p>Sets the logical operation for the functions set in H2-02 [Term M3-M4 Function Selection] and H2-63 [Term M3-M4 Secondary Function].</p>	0 (0 - 8)	869
H2-65 (1B4B) Expert	Terminal M3-M4 Delay Time	<p>V/f CL-V/f OLV CLV AOLV OLV/PM AOLV/PM CLV/PM EZOLV</p> <p>Sets the minimum on time used to output the logical calculation results from terminal M3-M4.</p>	0.1 s (0.0 - 25.0 s)	869
H2-66 (1B4C) Expert	Term M5-M6 Secondary Function	<p>V/f CL-V/f OLV CLV AOLV OLV/PM AOLV/PM CLV/PM EZOLV</p> <p>Sets the second function for terminal M5-M6. Outputs the logical calculation results of the terminals assigned to functions by H2-03 [Terminal M5-M6 Function Select].</p>	F (0 - FF)	869
H2-67 (1B4D) Expert	Terminal M5-M6 Logical Operation	<p>V/f CL-V/f OLV CLV AOLV OLV/PM AOLV/PM CLV/PM EZOLV</p> <p>Sets the logical operation for the functions set in H2-03 [Term M5-M6 Function Selection] and H2-66 [Term M5-M6 Secondary Function].</p>	0 (0 - 8)	869
H2-68 (1B4E) Expert	Terminal M5-M6 Delay Time	<p>V/f CL-V/f OLV CLV AOLV OLV/PM AOLV/PM CLV/PM EZOLV</p> <p>Sets the minimum on time used to output the logical calculation results from terminal M5-M6.</p>	0.1 s (0.0 - 25.0 s)	869

■ H2-xx: MFDO Setting Values

Setting Value	Function	Description	Ref.																														
0	During Run	<p>V/f CL-V/f OLV CLV AOLV OLV/PM AOLV/PM CLV/PM EZOLV</p> <p>The terminal activates when you input a Run command and when the drive is outputting voltage. ON : Drive is running OFF : Drive is stopping</p>	870																														
1	Zero Speed	<p>V/f CL-V/f OLV CLV AOLV OLV/PM AOLV/PM CLV/PM EZOLV</p> <p>The terminal activates when the output frequency < E1-09 [Minimum Output Frequency] or b2-01 [DC Injection/Zero SpeedThreshold].</p> <p>Note: Parameter A1-02 [Control Method Selection] selects which parameter is the reference.</p> <table border="1"> <thead> <tr> <th>A1-02 Setting</th> <th>Control method selection</th> <th>Parameter Used as the Reference</th> </tr> </thead> <tbody> <tr> <td>0</td> <td>V/f</td> <td>E1-09</td> </tr> <tr> <td>1</td> <td>CL-V/f</td> <td>E1-09</td> </tr> <tr> <td>2</td> <td>OLV</td> <td>b2-01</td> </tr> <tr> <td>3</td> <td>CLV</td> <td>E1-09</td> </tr> <tr> <td>4</td> <td>AOLV</td> <td>E1-09</td> </tr> <tr> <td>5</td> <td>OLV/PM</td> <td>E1-09</td> </tr> <tr> <td>6</td> <td>AOLV/PM</td> <td>E1-09</td> </tr> <tr> <td>7</td> <td>CLV/PM</td> <td>b2-01</td> </tr> <tr> <td>8</td> <td>EZOLV</td> <td>E1-09</td> </tr> </tbody> </table> <p>ON : Output frequency < value of E1-09 or b2-01. OFF : Output frequency ≥ value of E1-09 or b2-01.</p>	A1-02 Setting	Control method selection	Parameter Used as the Reference	0	V/f	E1-09	1	CL-V/f	E1-09	2	OLV	b2-01	3	CLV	E1-09	4	AOLV	E1-09	5	OLV/PM	E1-09	6	AOLV/PM	E1-09	7	CLV/PM	b2-01	8	EZOLV	E1-09	870
A1-02 Setting	Control method selection	Parameter Used as the Reference																															
0	V/f	E1-09																															
1	CL-V/f	E1-09																															
2	OLV	b2-01																															
3	CLV	E1-09																															
4	AOLV	E1-09																															
5	OLV/PM	E1-09																															
6	AOLV/PM	E1-09																															
7	CLV/PM	b2-01																															
8	EZOLV	E1-09																															
2	Speed Agree 1	<p>V/f CL-V/f OLV CLV AOLV OLV/PM AOLV/PM CLV/PM EZOLV</p> <p>The terminal turns on when the output frequency is in the range of the frequency reference ± L4-02 [Speed Agree Detection Width].</p> <p>Note:</p> <ul style="list-style-type: none"> The detection function operates in the two motor rotation directions. The drive outputs the motor speed status when A1-02 = 3, 7 [CLV, CLV/PM]. It also outputs the motor speed status when A1-02 = 4 and n4-72 = 1. <p>ON : The output frequency is in the range of “frequency reference ± L4-02”. OFF : The output frequency does not align with the frequency reference although the drive is running.</p>	870																														
3	User-Set Speed Agree 1	<p>V/f CL-V/f OLV CLV AOLV OLV/PM AOLV/PM CLV/PM EZOLV</p> <p>The terminal activates when the output frequency is in the range of L4-01 [Speed Agree Detection Level] ± L4-02 [Speed Agree Detection Width] and in the range of the frequency reference ± L4-02.</p> <p>Note:</p> <ul style="list-style-type: none"> The detection function operates in the two motor rotation directions. The drive uses the L4-01 value as the forward/reverse detection level. The drive outputs the motor speed status when A1-02 = 3, 7 [CLV, CLV/PM]. It also outputs the motor speed status when A1-02 = 4 and n4-72 = 1. <p>ON : The output frequency is in the range of “L4-01 ± L4-02” and the range of frequency reference ± L4-02. OFF : The output frequency is not in the range of “L4-01 ± L4-02” or the range of frequency reference ± L4-02.</p>	871																														
4	Frequency Detection 1	<p>V/f CL-V/f OLV CLV AOLV OLV/PM AOLV/PM CLV/PM EZOLV</p> <p>The terminal deactivates when the output frequency > “L4-01 [Speed Agree Detection Level] + L4-02 [Speed Agree Detection Width]”. After the terminal deactivates, the terminal stays deactivated until the output frequency is at the value of L4-01.</p> <p>Note:</p> <ul style="list-style-type: none"> The detection function operates in the two motor rotation directions. The drive uses the L4-01 value as the forward/reverse detection level. The drive outputs the motor speed status when A1-02 = 3, 7 [Control Method Selection = CLV, CLV/PM]. It also outputs the motor speed status when A1-02 = 4 [AOLV] and n4-72 = 1 [Speed Feedback Mode = With Encoder]. <p>ON : The output frequency < L4-01, or the output frequency ≤ “L4-01 + L4-02” OFF : The output frequency > “L4-01 + L4-02”</p>	871																														
5	Frequency Detection 2	<p>V/f CL-V/f OLV CLV AOLV OLV/PM AOLV/PM CLV/PM EZOLV</p> <p>The terminal activates when the output frequency > L4-01 [Speed Agree Detection Level]. After the terminal activates, the terminal stays activated until the output frequency is at the value of “L4-01 - L4-02”.</p> <p>Note:</p> <ul style="list-style-type: none"> The detection function operates in the two motor rotation directions. The drive uses the L4-01 value as the forward/reverse detection level. The drive outputs the motor speed status when A1-02 = 3, 7 [Control Method Selection = CLV, CLV/PM]. It also outputs the motor speed status when A1-02 = 4 [AOLV] and n4-72 = 1 [Speed Feedback Mode = With Encoder]. <p>ON : The output frequency > L4-01 OFF : The output frequency < “L4-01 - L4-02”, or the output frequency ≤ L4-01</p>	872																														
6	Drive Ready	<p>V/f CL-V/f OLV CLV AOLV OLV/PM AOLV/PM CLV/PM EZOLV</p> <p>The terminal activates when the drive is ready and running.</p>	872																														

11.10 H: Terminal Functions

Setting Value	Function	Description	Ref.
7	DC Bus Undervoltage	<p>V/f CL-V/f OLV CLV AOLV OLV/PM AOLV/PM CLV/PM EZOLV</p> <p>The terminal activates when the DC bus voltage or control circuit power supply is at the voltage set in L2-05 [Undervoltage Detection Lvl (Uv1)] or less. The terminal also activates when there is a fault with the DC bus voltage. ON : The DC bus voltage \leq L2-05 OFF : The DC bus voltage $>$ L2-05</p>	873
8	During Baseblock (N.O.)	<p>V/f CL-V/f OLV CLV AOLV OLV/PM AOLV/PM CLV/PM EZOLV</p> <p>The terminal activates during baseblock. When the drive is in baseblock, the drive output transistor stops switching and does not make DC bus voltage. ON : During baseblock OFF : The drive is not in baseblock.</p>	873
9	Frequency Reference from Keypad	<p>V/f CL-V/f OLV CLV AOLV OLV/PM AOLV/PM CLV/PM EZOLV</p> <p>Shows the selected frequency reference source. ON : The keypad is the frequency reference source. OFF : Parameter b1-01 or b1-15 [Frequency Reference Selection 1 or 2] is the frequency reference source.</p>	873
A	Run Command Source	<p>V/f CL-V/f OLV CLV AOLV OLV/PM AOLV/PM CLV/PM EZOLV</p> <p>Shows the selected Run command source. ON : The keypad is the Run command source. OFF : Parameter b1-02 or b1-16 [Run Command Selection 1 or 2] is the Run command source.</p>	873
B	Torque Detection 1 (N.O.)	<p>V/f CL-V/f OLV CLV AOLV OLV/PM AOLV/PM CLV/PM EZOLV</p> <p>The terminal activates when the drive detects overtorque or undertorque. ON : The output current/torque $>$ L6-02 [Torque Detection Level 1], or the output current/torque $<$ L6-02 for longer than the time set in L6-03 [Torque Detection Time 1].</p>	873
C	Frequency Reference Loss	<p>V/f CL-V/f OLV CLV AOLV OLV/PM AOLV/PM CLV/PM EZOLV</p> <p>The terminal activates when the drive detects a loss of frequency reference.</p>	873
D	Braking Resistor Fault	<p>V/f CL-V/f OLV CLV AOLV OLV/PM AOLV/PM CLV/PM EZOLV</p> <p>The terminal activates when the mounting-type braking resistor is overheating or when there is a braking transistor fault.</p>	874
E	Fault	<p>V/f CL-V/f OLV CLV AOLV OLV/PM AOLV/PM CLV/PM EZOLV</p> <p>The terminal activates when the drive detects a fault. Note: The terminal will not activate for CPF00 and CPF01 [Control Circuit Error] faults.</p>	874
F	Not Used	<p>V/f CL-V/f OLV CLV AOLV OLV/PM AOLV/PM CLV/PM EZOLV</p> <p>Use this setting for unused terminals or to use terminals in through mode. Also use this setting as the PLC contact output via MEMOBUS/Modbus or the communication option. This signal does not function if you do not configure signals from the PLC.</p>	874
10	Alarm	<p>V/f CL-V/f OLV CLV AOLV OLV/PM AOLV/PM CLV/PM EZOLV</p> <p>The terminal activates when the drive detects a minor fault.</p>	874
11	Fault Reset Command Active	<p>V/f CL-V/f OLV CLV AOLV OLV/PM AOLV/PM CLV/PM EZOLV</p> <p>The terminal activates when the drive receives the Reset command from the control circuit terminal, serial communications, or the communication option.</p>	874
12	Timer Output	<p>V/f CL-V/f OLV CLV AOLV OLV/PM AOLV/PM CLV/PM EZOLV</p> <p>Sets the terminal as the timer output. Use this setting with the timer input set in H1-xx = 18 [MFDI Function Selection = Timer Function].</p>	874
13	Speed Agree 2	<p>V/f CL-V/f OLV CLV AOLV OLV/PM AOLV/PM CLV/PM EZOLV</p> <p>The terminal activates when the output frequency is in the range of the frequency reference \pm L4-04 [Speed Agree Detection Width (+/-)]. Note: <ul style="list-style-type: none"> The detection function operates in the two motor rotation directions. The drive outputs the motor speed status when A1-02 = 3, 7 [Control Method Selection = CLV, CLV/PM]. ON : The output frequency is in the range of "frequency reference \pm L4-04". OFF : The output frequency is not in the range of "frequency reference \pm L4-04".</p>	874
14	User-Set Speed Agree 2	<p>V/f CL-V/f OLV CLV AOLV OLV/PM AOLV/PM CLV/PM EZOLV</p> <p>The terminal activates when the output frequency is in the range of L4-03 [Speed Agree Detection Level (+/-)] \pm L4-04 [Speed Agree Detection Width (+/-)] and in the range of the frequency reference \pm L4-04. Note: <ul style="list-style-type: none"> The detection level set in L4-03 is a signed value. The drive will only detect in one direction. The drive outputs the motor speed status when A1-02 = 3, 7 [Control Method Selection = CLV, CLV/PM]. ON : The output frequency is in the range of "L4-03 \pm L4-04" and the range of frequency reference \pm L4-04. OFF : The output frequency is not in the range of "L4-03 \pm L4-04" or the range of frequency reference \pm L4-04.</p>	875
15	Frequency Detection 3	<p>V/f CL-V/f OLV CLV AOLV OLV/PM AOLV/PM CLV/PM EZOLV</p> <p>The terminal deactivates when the output frequency $>$ "L4-03 [Speed Agree Detection Level(+/-)] + L4-04 [Speed Agree Detection Width(+/-)]". After the terminal deactivates, the terminal stays deactivated until the output frequency is at the value of L4-03. Note: <ul style="list-style-type: none"> The detection level set in L4-03 is a signed value. The drive will only detect in one direction. The drive outputs the motor speed status when A1-02 = 3, 7 [Control Method Selection = CLV, CLV/PM]. ON : The output frequency $<$ L4-03, or the output frequency \leq "L4-03 + L4-04" OFF : The output frequency $>$ "L4-03 + L4-04"</p>	875

Setting Value	Function	Description	Ref.
16	Frequency Detection 4	<p>V/f CL-V/f OLV CLV AOLV OLV/PM AOLV/PM CLV/PM EZOLV</p> <p>The terminal activates when the output frequency > L4-03 [Speed Agree Detection Level(+/-)]. After the terminal activates, the terminal stays activated until the output frequency is at the value of "L4-03 - L4-04".</p> <p>Note:</p> <ul style="list-style-type: none"> The detection level set in L4-03 is a signed value. The drive will only detect in one direction. The drive outputs the motor speed status when A1-02 = 3, 7 [Control Method Selection = CLV, CLV/PM]. <p>ON : The output frequency > L4-03 OFF : The output frequency < "L4-03 - L4-04", or the output frequency ≤ L4-03</p>	876
17	Torque Detection 1 (N.C.)	<p>V/f CL-V/f OLV CLV AOLV OLV/PM AOLV/PM CLV/PM EZOLV</p> <p>The terminal deactivates when the drive detects overtorque or undertorque.</p> <p>OFF : The output current/torque > L6-02 [Torque Detection Level 1], or the output current/torque < L6-02 for longer than the time set in L6-03 [Torque Detection Time 1].</p>	876
18	Torque Detection 2 (N.O.)	<p>V/f CL-V/f OLV CLV AOLV OLV/PM AOLV/PM CLV/PM EZOLV</p> <p>The terminal activates when the drive detects overtorque or undertorque.</p> <p>ON : The output current/torque > L6-05 [Torque Detection Level 2], or the output current/torque < L6-05 for longer than the time set in L6-06 [Torque Detection Time 2].</p>	876
19	Torque Detection 2 (N.C.)	<p>V/f CL-V/f OLV CLV AOLV OLV/PM AOLV/PM CLV/PM EZOLV</p> <p>The terminal deactivates when the drive detects overtorque or undertorque.</p> <p>OFF : The output current/torque > L6-05 [Torque Detection Level 2], or the output current/torque < L6-05 for longer than the time set in L6-06 [Torque Detection Time 2].</p>	877
1A	During Reverse	<p>V/f CL-V/f OLV CLV AOLV OLV/PM AOLV/PM CLV/PM EZOLV</p> <p>The terminal activates when the motor operates in the reverse direction.</p> <p>ON : The motor is operating in the reverse direction. OFF : The motor is operating in the forward direction or the motor stopped.</p>	877
1B	During Baseblock (N.C.)	<p>V/f CL-V/f OLV CLV AOLV OLV/PM AOLV/PM CLV/PM EZOLV</p> <p>The terminal deactivates during baseblock. When the drive is in baseblock, the drive output transistor stops switching and does not make DC bus voltage.</p> <p>ON : The drive is not in baseblock. OFF : During baseblock</p>	877
1C	Motor 2 Selected	<p>V/f CL-V/f OLV CLV AOLV OLV/PM AOLV/PM CLV/PM EZOLV</p> <p>The terminal activates when you select motor 2.</p> <p>ON : Motor 2 Selected OFF : Motor 1 Selected</p>	877
1D	During Regeneration	<p>V/f CL-V/f OLV CLV AOLV OLV/PM AOLV/PM CLV/PM EZOLV</p> <p>The terminal activates on when the motor is regenerating.</p> <p>ON : Motor is regenerating. OFF : Motor is operating or stopped.</p>	877
1E	Executing Auto-Restart	<p>V/f CL-V/f OLV CLV AOLV OLV/PM AOLV/PM CLV/PM EZOLV</p> <p>The terminal activates when the Auto Restart function is trying to restart after a fault.</p>	878
1F	Motor Overload Alarm (oL1)	<p>V/f CL-V/f OLV CLV AOLV OLV/PM AOLV/PM CLV/PM EZOLV</p> <p>The terminal activates when the electronic thermal protection value of the motor overload protective function is a minimum of 90% of the detection level.</p>	878
20	Drive Overheat Pre-Alarm (oH)	<p>V/f CL-V/f OLV CLV AOLV OLV/PM AOLV/PM CLV/PM EZOLV</p> <p>The terminal activates when the drive heatsink temperature is at the level set with L8-02 [Overheat Alarm Level].</p>	878
21	Safety Monitor Output Status	<p>V/f CL-V/f OLV CLV AOLV OLV/PM AOLV/PM CLV/PM EZOLV</p> <p>The terminal activates (safety stop state) when the safety circuit and safety diagnosis circuit are operating correctly and when terminals H1-HC and H2-HC are OFF (Open).</p> <p>ON : Safety stop state OFF : Safety circuit fault or RUN/READY</p>	878
22	Mechanical Weakening Detection	<p>V/f CL-V/f OLV CLV AOLV OLV/PM AOLV/PM CLV/PM EZOLV</p> <p>The terminal activates when the drive detects mechanical weakening.</p>	878
2F	Maintenance Notification	<p>V/f CL-V/f OLV CLV AOLV OLV/PM AOLV/PM CLV/PM EZOLV</p> <p>The terminal activates when drive components are at their estimated maintenance period.</p> <p>Tells you about the maintenance period for these items:</p> <ul style="list-style-type: none"> IGBT Cooling Fan Capacitor Soft charge bypass relay 	878
30	During Torque Limit	<p>V/f CL-V/f OLV CLV AOLV OLV/PM AOLV/PM CLV/PM EZOLV</p> <p>The terminal activates when the torque reference is the torque limit set with L7 parameters, H3-02, H3-06, or H3-10 [MFAl Function Selection].</p>	879
31	During Speed Limit	<p>V/f CL-V/f OLV CLV AOLV OLV/PM AOLV/PM CLV/PM EZOLV</p> <p>The terminal activates when the speed limit is active.</p>	879
32	In Speed Limit During Trq Ctrl	<p>V/f CL-V/f OLV CLV AOLV OLV/PM AOLV/PM CLV/PM EZOLV</p> <p>The motor accelerates in the forward direction or the reverse direction after enabling torque control and the externally input torque reference is disproportionate to the load. The output terminal activates when this speed is not higher than a constant speed and the motor speed is at the speed limit. This does not include operation when the drive is stopped.</p>	879

11.10 H: Terminal Functions

Setting Value	Function	Description	Ref.
33	Zero Servo Complete	<p>V/f CL-V/f OLV CLV AOLV OLV/PM AOLV/PM CLV/PM EZOLV</p> <p>The terminal activates when positioning in the range set with <i>b9-02 [Zero Servo Completion Window]</i> completes after sending the Zero-Servo command.</p>	879
37	During Frequency Output	<p>V/f CL-V/f OLV CLV AOLV OLV/PM AOLV/PM CLV/PM EZOLV</p> <p>The terminal activates when the drive outputs frequency. ON : The drive is outputting frequency. OFF : The drive is not outputting frequency.</p>	879
38	Drive Enabled	<p>V/f CL-V/f OLV CLV AOLV OLV/PM AOLV/PM CLV/PM EZOLV</p> <p>This terminal activates when the <i>H1-xx = 6A [Drive Enable]</i> terminal activates.</p>	880
39	Watt Hour Pulse Output	<p>V/f CL-V/f OLV CLV AOLV OLV/PM AOLV/PM CLV/PM EZOLV</p> <p>Outputs the pulse that shows the watt hours.</p>	880
3C	LOCAL Control Selected	<p>V/f CL-V/f OLV CLV AOLV OLV/PM AOLV/PM CLV/PM EZOLV</p> <p>The terminal activates when the Run command source or frequency reference source is LOCAL. ON : LOCAL OFF : REMOTE</p>	880
3D	During Speed Search	<p>V/f CL-V/f OLV CLV AOLV OLV/PM AOLV/PM CLV/PM EZOLV</p> <p>The terminal activates when the drive is doing speed search.</p>	880
3E	PID Feedback Low	<p>V/f CL-V/f OLV CLV AOLV OLV/PM AOLV/PM CLV/PM EZOLV</p> <p>The terminal activates when the drive detects <i>FbL [PID Feedback Loss]</i>.</p>	880
3F	PID Feedback High	<p>V/f CL-V/f OLV CLV AOLV OLV/PM AOLV/PM CLV/PM EZOLV</p> <p>The terminal activates when the drive detects <i>FbH [Excessive PID Feedback]</i>.</p>	881
4 A	During KEB Ride-Thru	<p>V/f CL-V/f OLV CLV AOLV OLV/PM AOLV/PM CLV/PM EZOLV</p> <p>The activates during KEB Ride-Thru.</p>	881
4B	During Short Circuit Braking	<p>V/f CL-V/f OLV CLV AOLV OLV/PM AOLV/PM CLV/PM EZOLV</p> <p>The terminal activates during Short Circuit Braking. Note: When <i>A1-02 = 8 [Control Method Selection = EZOLV]</i>, this function is available only when you use a PM motor.</p>	881
4C	During Fast Stop	<p>V/f CL-V/f OLV CLV AOLV OLV/PM AOLV/PM CLV/PM EZOLV</p> <p>The terminal activates when the fast stop is in operation.</p>	881
4D	oH Pre-Alarm Time Limit	<p>V/f CL-V/f OLV CLV AOLV OLV/PM AOLV/PM CLV/PM EZOLV</p> <p>The terminal activates when <i>L8-03 = 4 [Overheat Pre-Alarm Selection = Operate at Reduced Speed (L8-19)]</i> and <i>oH [Heatsink Overheat]</i> does not clear after the drive decreases the frequency for 10 cycles.</p>	881
4E	Braking Transistor Fault (rr)	<p>V/f CL-V/f OLV CLV AOLV OLV/PM AOLV/PM CLV/PM EZOLV</p> <p>The terminal activates when the internal braking transistor overheats and the drive detects an <i>rr [Dynamic Braking Transistor Fault]</i> fault.</p>	881
4F	Braking Resistor Overheat (rH)	<p>V/f CL-V/f OLV CLV AOLV OLV/PM AOLV/PM CLV/PM EZOLV</p> <p>The terminal activates when the braking resistor overheats and the drive detects an <i>rH [Braking Resistor Overheat]</i> fault.</p>	881
60	Internal Cooling Fan Failure	<p>V/f CL-V/f OLV CLV AOLV OLV/PM AOLV/PM CLV/PM EZOLV</p> <p>The terminal activates when the drive detects a cooling fan failure in the drive.</p>	881
61	Pole Position Detection Complete	<p>V/f CL-V/f OLV CLV AOLV OLV/PM AOLV/PM CLV/PM EZOLV</p> <p>The terminal activates when drive receives a Run command and the drive detects the motor magnetic pole position of the PM motor.</p>	882
62	Modbus Reg 1 Status Satisfied	<p>V/f CL-V/f OLV CLV AOLV OLV/PM AOLV/PM CLV/PM EZOLV</p> <p>The terminal activates when the bit specified by <i>H2-08 [Modbus Register 1 Bit Select]</i> for the MEMOBUS register address set with <i>H2-07 [Modbus Register 1 Address Select]</i> activates.</p>	882
63	Modbus Reg 2 Status Satisfied	<p>V/f CL-V/f OLV CLV AOLV OLV/PM AOLV/PM CLV/PM EZOLV</p> <p>The terminal activates when the bit specified by <i>H2-10 [Modbus Register 2 Bit Select]</i> for the MEMOBUS register address set with <i>H2-09 [Modbus Register 2 Address Select]</i> activates.</p>	882
65	Standby Output	<p>V/f CL-V/f OLV CLV AOLV OLV/PM AOLV/PM CLV/PM EZOLV</p> <p>The terminal deactivates after the drive stops operating and after the time set with <i>b8-51 [Standby Mode Wait Time]</i>. ON : The Run command turns on and the magnetic contactor on the input side turns on. OFF : The Run command turns off and the drive stops operating. Then, the magnetic contactor on the input side turns off after the time set in <i>b8-51 [Standby Mode Wait Time]</i> elapses.</p>	882
66	Comparator1	<p>V/f CL-V/f OLV CLV AOLV OLV/PM AOLV/PM CLV/PM EZOLV</p> <p>The terminal activates if the monitor value set with <i>H2-20 [Comparator 1 Monitor Selection]</i> is in range of the values of <i>H2-21 [Comparator 1 Lower Limit]</i> and <i>H2-22 [Comparator 1 Upper Limit]</i> for the time set in <i>H2-24 [Comparator 1 On-Delay Time]</i>.</p>	882
67	Comparator2	<p>V/f CL-V/f OLV CLV AOLV OLV/PM AOLV/PM CLV/PM EZOLV</p> <p>The terminal activates if the monitor value set with <i>H2-26 [Comparator 2 Monitor Selection]</i> is not in the range of the values of <i>H2-27 [Comparator 2 Lower Limit]</i> and <i>H2-28 [Comparator 2 Upper Limit]</i> for the time set in <i>H2-30 [Comparator 2 On-Delay Time]</i>.</p>	883

Setting Value	Function	Description	Ref.																														
69	External Power 24V Supply	<p>V/f CL-V/f OLV CLV AOLV OLV/PM AOLV/PM CLV/PM EZOLV</p> <p>The terminal activates when there is an external 24V power supply between terminals PS-AC. ON : The external 24V power supply is supplying power. OFF : The external 24V power supply is not supplying power.</p>	883																														
6 A	Data Logger Error	<p>V/f CL-V/f OLV CLV AOLV OLV/PM AOLV/PM CLV/PM EZOLV</p> <p>The terminal activates when the drive detects a <i>LoG [Com Error / Abnormal SD card]</i>.</p>	883																														
90	DWEZ Digital Output 1	<p>V/f CL-V/f OLV CLV AOLV OLV/PM AOLV/PM CLV/PM EZOLV</p> <p>Sets the DriveWorksEZ digital output 1. Refer to the DriveWorksEZ online manual for more information.</p>	884																														
91	DWEZ Digital Output 2	<p>V/f CL-V/f OLV CLV AOLV OLV/PM AOLV/PM CLV/PM EZOLV</p> <p>Sets the DriveWorksEZ digital output 2. Refer to the DriveWorksEZ online manual for more information.</p>	884																														
92	DWEZ Digital Output 3	<p>V/f CL-V/f OLV CLV AOLV OLV/PM AOLV/PM CLV/PM EZOLV</p> <p>Sets the DriveWorksEZ digital output 3. Refer to the DriveWorksEZ online manual for more information.</p>	884																														
93	DWEZ Digital Output 4	<p>V/f CL-V/f OLV CLV AOLV OLV/PM AOLV/PM CLV/PM EZOLV</p> <p>Sets the DriveWorksEZ digital output 4. Refer to the DriveWorksEZ online manual for more information.</p>	884																														
A0	DWEZ Extended Digital Output 1	<p>V/f CL-V/f OLV CLV AOLV OLV/PM AOLV/PM CLV/PM EZOLV</p> <p>Sets the DriveWorksEZ digital output 1. Refer to the DriveWorksEZ online manual for more information.</p>	884																														
A1	DWEZ Extended Digital Output 2	<p>V/f CL-V/f OLV CLV AOLV OLV/PM AOLV/PM CLV/PM EZOLV</p> <p>Sets the DriveWorksEZ digital output 2. Refer to the DriveWorksEZ online manual for more information.</p>	884																														
A2	DWEZ Extended Digital Output 3	<p>V/f CL-V/f OLV CLV AOLV OLV/PM AOLV/PM CLV/PM EZOLV</p> <p>Sets the DriveWorksEZ digital output 3. Refer to the DriveWorksEZ online manual for more information.</p>	884																														
A3	DWEZ Extended Digital Output 4	<p>V/f CL-V/f OLV CLV AOLV OLV/PM AOLV/PM CLV/PM EZOLV</p> <p>Sets the DriveWorksEZ digital output 4. Refer to the DriveWorksEZ online manual for more information.</p>	884																														
A4	DWEZ Extended Digital Output 5	<p>V/f CL-V/f OLV CLV AOLV OLV/PM AOLV/PM CLV/PM EZOLV</p> <p>Sets the DriveWorksEZ digital output 5. Refer to the DriveWorksEZ online manual for more information.</p>	884																														
A5	DWEZ Extended Digital Output 6	<p>V/f CL-V/f OLV CLV AOLV OLV/PM AOLV/PM CLV/PM EZOLV</p> <p>Sets the DriveWorksEZ digital output 6. Refer to the DriveWorksEZ online manual for more information.</p>	884																														
A6	DWEZ Extended Digital Output 7	<p>V/f CL-V/f OLV CLV AOLV OLV/PM AOLV/PM CLV/PM EZOLV</p> <p>Sets the DriveWorksEZ digital output 7. Refer to the DriveWorksEZ online manual for more information.</p>	884																														
A7	DWEZ Extended Digital Output 8	<p>V/f CL-V/f OLV CLV AOLV OLV/PM AOLV/PM CLV/PM EZOLV</p> <p>Sets the DriveWorksEZ digital output 8. Refer to the DriveWorksEZ online manual for more information.</p>	884																														
100	!During Run	<p>V/f CL-V/f OLV CLV AOLV OLV/PM AOLV/PM CLV/PM EZOLV</p> <p>The terminal deactivates when you input a Run command and when the drive is outputting voltage. ON : Drive is stopping OFF : Drive is running</p>	884																														
101	!Zero Speed	<p>V/f CL-V/f OLV CLV AOLV OLV/PM AOLV/PM CLV/PM EZOLV</p> <p>The terminal deactivates when the output frequency is less than <i>E1-09 [Minimum Output Frequency]</i> or <i>b2-01 [DC Injection/Zero SpeedThreshold]</i>.</p> <p>Note: Parameter <i>A1-02 [Control Method Selection]</i> selects which parameter is the reference.</p> <table border="1"> <thead> <tr> <th>A1-02 Setting</th> <th>Description</th> <th>Parameter Used as the Reference</th> </tr> </thead> <tbody> <tr> <td>0</td> <td>Open Loop V/f Control</td> <td><i>E1-09</i></td> </tr> <tr> <td>1</td> <td>V/f Control with Encoder</td> <td><i>E1-09</i></td> </tr> <tr> <td>2</td> <td>Open Loop Vector</td> <td><i>b2-01</i></td> </tr> <tr> <td>3</td> <td>Closed Loop Vector</td> <td><i>E1-09</i></td> </tr> <tr> <td>4</td> <td>Advanced OpenLoop Vector Control</td> <td><i>E1-09</i></td> </tr> <tr> <td>5</td> <td>PM Open Loop Vector Control</td> <td><i>E1-09</i></td> </tr> <tr> <td>6</td> <td>PM Advanced Open Loop Vector</td> <td><i>E1-09</i></td> </tr> <tr> <td>7</td> <td>PM Closed Loop Vector Control</td> <td><i>b2-01</i></td> </tr> <tr> <td>8</td> <td>EZ Open Loop Vector Control</td> <td><i>E1-09</i></td> </tr> </tbody> </table> <p>ON : The output frequency is the value of <i>E1-09</i> or more, or <i>b2-01</i> or more. OFF : The output frequency is less than the value of <i>E1-09</i> or <i>b2-01</i>.</p>	A1-02 Setting	Description	Parameter Used as the Reference	0	Open Loop V/f Control	<i>E1-09</i>	1	V/f Control with Encoder	<i>E1-09</i>	2	Open Loop Vector	<i>b2-01</i>	3	Closed Loop Vector	<i>E1-09</i>	4	Advanced OpenLoop Vector Control	<i>E1-09</i>	5	PM Open Loop Vector Control	<i>E1-09</i>	6	PM Advanced Open Loop Vector	<i>E1-09</i>	7	PM Closed Loop Vector Control	<i>b2-01</i>	8	EZ Open Loop Vector Control	<i>E1-09</i>	884
A1-02 Setting	Description	Parameter Used as the Reference																															
0	Open Loop V/f Control	<i>E1-09</i>																															
1	V/f Control with Encoder	<i>E1-09</i>																															
2	Open Loop Vector	<i>b2-01</i>																															
3	Closed Loop Vector	<i>E1-09</i>																															
4	Advanced OpenLoop Vector Control	<i>E1-09</i>																															
5	PM Open Loop Vector Control	<i>E1-09</i>																															
6	PM Advanced Open Loop Vector	<i>E1-09</i>																															
7	PM Closed Loop Vector Control	<i>b2-01</i>																															
8	EZ Open Loop Vector Control	<i>E1-09</i>																															
102	!Speed Agree 1	<p>V/f CL-V/f OLV CLV AOLV OLV/PM AOLV/PM CLV/PM EZOLV</p> <p>The terminal deactivates when the output frequency is in the range of the frequency reference \pm <i>L4-02 [Speed Agree Detection Width]</i>.</p> <p>Note: In CLV, the motor speed is the reference. ON : The output frequency does not align with the frequency reference although the drive is running. OFF : The output frequency is in the range of "frequency reference \pm <i>L4-02</i>".</p>	884																														

11.10 H: Terminal Functions

Setting Value	Function	Description	Ref.
103	!User-Set Speed Agree 1	<p>V/f CL-V/f OLV CLV AOLV OLV/PM AOLV/PM CLV/PM EZOLV</p> <p>The terminal deactivates when the output frequency is in the range of $L4-01$ [Speed Agree Detection Level] \pm $L4-02$ [Speed Agree Detection Width] and in the range of the frequency reference \pm $L4-02$.</p> <p>Note:</p> <ul style="list-style-type: none"> The detection function operates in the two motor rotation directions. The drive uses the $L4-01$ value as the forward/reverse detection level. When using Closed Loop Vector Control, this is the value of "Motor Speed \pm $L4-02$." <p>ON : The output frequency is not in the range of "$L4-01 \pm L4-02$" nor the range of frequency reference \pm $L4-02$.</p> <p>OFF : The output frequency is in the range of "$L4-01 \pm L4-02$" and the range of frequency reference \pm $L4-02$.</p>	884
104	!Frequency Detection 1	<p>V/f CL-V/f OLV CLV AOLV OLV/PM AOLV/PM CLV/PM EZOLV</p> <p>The terminal deactivates when the output frequency is higher than the value of $L4-01$ [Speed Agree Detection Level] + $L4-02$ [Speed Agree Detection Width]. When the terminal activates, it stays activated until the output frequency = $L4-01$.</p> <p>Note:</p> <ul style="list-style-type: none"> The detection function operates in the two motor rotation directions. The drive uses the $L4-01$ value as the forward/reverse detection level. In CLV, the motor speed is the reference. <p>ON : The output frequency is higher than $L4-01 + L4-02$.</p> <p>OFF : The output frequency is less than $L4-01$ or is not more than $L4-01 + L4-02$.</p>	884
105	!Frequency Detection 2	<p>V/f CL-V/f OLV CLV AOLV OLV/PM AOLV/PM CLV/PM EZOLV</p> <p>The terminal deactivates when the output frequency is higher than the value of $L4-01$ [Speed Agree Detection Level]. When the terminal deactivates, it stays deactivated until the output frequency = $L4-01 - L4-02$.</p> <p>ON : The output frequency is less than "$L4-01 - L4-02$," or it is not more than $L4-01$.</p> <p>OFF : The output frequency is more than $L4-01$.</p>	884
106	!Drive Ready	<p>V/f CL-V/f OLV CLV AOLV OLV/PM AOLV/PM CLV/PM EZOLV</p> <p>The terminal deactivates when the drive is ready and running.</p>	884
107	!DC Bus Undervoltage	<p>V/f CL-V/f OLV CLV AOLV OLV/PM AOLV/PM CLV/PM EZOLV</p> <p>The terminal deactivates when the DC bus voltage or control circuit power supply is at or below the voltage set in $L2-05$ [Undervoltage Detection Lvl (Uv1)]. The terminal also deactivates when there is a fault with the DC bus voltage.</p> <p>ON : The DC bus voltage is more than the setting value of $L2-05$.</p> <p>OFF : The DC bus voltage is less than the setting value of $L2-05$.</p>	884
108	During Baseblock (N.C.)	<p>V/f CL-V/f OLV CLV AOLV OLV/PM AOLV/PM CLV/PM EZOLV</p> <p>The terminal deactivates during baseblock. When the drive is in baseblock, the drive output transistor stops switching and does not make DC bus voltage.</p> <p>ON : The drive is not in baseblock.</p> <p>OFF : During baseblock</p>	884
109	!Frequency Reference from Keypad	<p>V/f CL-V/f OLV CLV AOLV OLV/PM AOLV/PM CLV/PM EZOLV</p> <p>Shows the selected frequency reference source.</p> <p>ON : $b1-01$ [Frequency Reference Selection 1] or $b1-15$ [Frequency Reference Selection 2] is the frequency reference source.</p> <p>OFF : The keypad is the frequency reference source.</p>	884
10A	!Run Command from Keypad	<p>V/f CL-V/f OLV CLV AOLV OLV/PM AOLV/PM CLV/PM EZOLV</p> <p>Shows the selected Run command source.</p> <p>ON : $b1-02$ [Run Command Selection 1] or $b1-16$ [Run Command Selection 2] is the Run command source.</p> <p>OFF : The keypad is the Run command source.</p>	884
10B	Torque Detection 1 (N.C.)	<p>V/f CL-V/f OLV CLV AOLV OLV/PM AOLV/PM CLV/PM EZOLV</p> <p>The terminal deactivates when the drive detects overtorque or undertorque.</p> <p>OFF : The output current/torque exceeds the torque value set with $L6-02$ [Torque Detection Level 1], or the level has dropped and remained in this state longer than the time set with $L6-03$ [Torque Detection Time 1].</p>	884
10C	!Frequency Reference Loss	<p>V/f CL-V/f OLV CLV AOLV OLV/PM AOLV/PM CLV/PM EZOLV</p> <p>The terminal deactivates when the drive detects a loss of frequency reference.</p>	884
10D	!Braking Resistor Fault	<p>V/f CL-V/f OLV CLV AOLV OLV/PM AOLV/PM CLV/PM EZOLV</p> <p>The terminal deactivates when the mounting-type braking resistor is overheating or when there is a braking transistor fault.</p>	884
10E	!Fault	<p>V/f CL-V/f OLV CLV AOLV OLV/PM AOLV/PM CLV/PM EZOLV</p> <p>The terminal deactivates when the drive detects a fault.</p> <p>Note:</p> <p>Faults $CPF00$ and $CPF01$ [Control Circuit Error] are excluded.</p>	884
110	!Alarm	<p>V/f CL-V/f OLV CLV AOLV OLV/PM AOLV/PM CLV/PM EZOLV</p> <p>The terminal deactivates when the drive detects a minor fault.</p>	884
111	!Fault Reset Command Active	<p>V/f CL-V/f OLV CLV AOLV OLV/PM AOLV/PM CLV/PM EZOLV</p> <p>The terminal deactivates when the drive receives the Reset command from the control circuit terminal, serial communications, or the communication option.</p>	884
112	!Timer Output	<p>V/f CL-V/f OLV CLV AOLV OLV/PM AOLV/PM CLV/PM EZOLV</p> <p>Sets the terminal as the timer output. Use this setting with the timer input set in $H1-xx = 118$ [MFDI Function Selection = !Timer Function].</p>	884

Setting Value	Function	Description	Ref.
113	!Speed Agree 2	<p>V/f CL-V/f OLV CLV AOLV OLV/PM AOLV/PM CLV/PM EZOLV</p> <p>The terminal deactivates when the output frequency is in the range of the frequency reference $\pm L4-04$ [Speed Agree Detection Width(+/-)].</p> <p>Note: The drive uses the motor speed as the reference in CLV and CLV/PM. ON : The output frequency is not in the range of "frequency reference $\pm L4-04$". OFF : The output frequency is in the range of "frequency reference $\pm L4-04$".</p>	884
114	!User-Set Speed Agree 2	<p>V/f CL-V/f OLV CLV AOLV OLV/PM AOLV/PM CLV/PM EZOLV</p> <p>The terminal deactivates when the output frequency is in the range of $L4-03$ [Speed Agree Detection Level(+/-)] $\pm L4-04$ [Speed Agree Detection Width(+/-)] and in the range of the frequency reference $\pm L4-04$.</p> <p>ON : The output frequency is not in the range of "$L4-03 \pm L4-04$" nor the range of frequency reference $\pm L4-04$. OFF : The output frequency is in the range of "$L4-03 \pm L4-04$" and the range of frequency reference $\pm L4-04$.</p>	884
115	!Frequency Detection 3	<p>V/f CL-V/f OLV CLV AOLV OLV/PM AOLV/PM CLV/PM EZOLV</p> <p>The terminal activates when the output frequency is higher than "$L4-03$ [Speed Agree Detection Level(+/-)] + $L4-04$ [Speed Agree Detection Width(+/-)]". When the terminal activates, it stays activated until the output frequency = $L4-03$.</p> <p>Note: • The detection level set in $L4-03$ is a signed value. Detections only occur one specific orientation. • The drive uses the motor speed as the reference in CLV and CLV/PM. ON : The output frequency is higher than $L4-03 + L4-04$. OFF : The output frequency is less than $L4-03$ or is not more than $L4-03 + L4-04$.</p>	884
116	!Frequency Detection 4	<p>V/f CL-V/f OLV CLV AOLV OLV/PM AOLV/PM CLV/PM EZOLV</p> <p>The terminal deactivates when the output frequency is higher than the value of $L4-03$ [Speed Agree Detection Level(+/-)]. After the terminal deactivates, the terminal stays deactivated until the output frequency = $L4-03 - L4-04$.</p> <p>ON : The output frequency is less than "$L4-03 - L4-04$," or it is not more than $L4-03$. OFF : The output frequency is more than $L4-03$.</p>	884
117	Torque Detection 1 (N. O.)	<p>V/f CL-V/f OLV CLV AOLV OLV/PM AOLV/PM CLV/PM EZOLV</p> <p>The terminal activates when the drive detects overtorque or undertorque.</p> <p>ON : The output current/torque exceeds the torque value set with $L6-02$ [Torque Detection Level 1], or the level has dropped and remained in this state longer than the time set with $L6-03$ [Torque Detection Time 1].</p>	884
118	Torque Detection 2 (N. C.)	<p>V/f CL-V/f OLV CLV AOLV OLV/PM AOLV/PM CLV/PM EZOLV</p> <p>The terminal deactivates when the drive detects overtorque or undertorque.</p> <p>OFF : The output current/torque exceeds the torque value set with $L6-05$ [Torque Detection Level 2], or the level has dropped and remained in this state longer than the time set with $L6-06$ [Torque Detection Time 2].</p>	884
119	Torque Detection 2 (N. O.)	<p>V/f CL-V/f OLV CLV AOLV OLV/PM AOLV/PM CLV/PM EZOLV</p> <p>The terminal activates when the drive detects overtorque or undertorque.</p> <p>ON : The output current/torque exceeds the torque value set with $L6-05$ [Torque Detection Level 2], or the level has dropped and remained in this state longer than the time set with $L6-06$ [Torque Detection Time 2].</p>	884
11A	!During Reverse	<p>V/f CL-V/f OLV CLV AOLV OLV/PM AOLV/PM CLV/PM EZOLV</p> <p>The terminal deactivates when the motor operates in the reverse direction.</p> <p>ON : The motor is operating in the forward direction or the motor stopped. OFF : The motor is operating in the reverse direction.</p>	884
11B	During Baseblock (N.O.)	<p>V/f CL-V/f OLV CLV AOLV OLV/PM AOLV/PM CLV/PM EZOLV</p> <p>The terminal activates during baseblock. When the drive is in baseblock, the drive output transistor stops switching and does not make DC bus voltage.</p> <p>ON : During baseblock OFF : The drive is not in baseblock.</p>	884
11C	!Motor 2 Selected	<p>V/f CL-V/f OLV CLV AOLV OLV/PM AOLV/PM CLV/PM EZOLV</p> <p>The terminal deactivates when motor 2 is selected.</p> <p>ON : Motor 1 Selection OFF : Motor 2 Selection</p>	884
11D	!During Regeneration	<p>V/f CL-V/f OLV CLV AOLV OLV/PM AOLV/PM CLV/PM EZOLV</p> <p>The terminal deactivates when the motor is regenerating.</p> <p>ON : Motor is operating or stopped. OFF : Motor is regenerating.</p>	884
11E	!Executing Auto-Restart	<p>V/f CL-V/f OLV CLV AOLV OLV/PM AOLV/PM CLV/PM EZOLV</p> <p>The terminal deactivates when the Auto Restart function is trying to restart after a fault.</p>	884
11F	!Motor Overload Alarm (oL1)	<p>V/f CL-V/f OLV CLV AOLV OLV/PM AOLV/PM CLV/PM EZOLV</p> <p>The terminal deactivates when the electronic thermal protection value of the motor overload protective function is a minimum of 90% of the detection level.</p>	884
120	!Drive Overheat Pre-Alarm (oH)	<p>V/f CL-V/f OLV CLV AOLV OLV/PM AOLV/PM CLV/PM EZOLV</p> <p>The terminal deactivates when the drive heatsink temperature is at the level set with $L8-02$ [Overheat Alarm Level].</p>	884
121	!Safe Torque OFF	<p>V/f CL-V/f OLV CLV AOLV OLV/PM AOLV/PM CLV/PM EZOLV</p> <p>The terminal deactivates (safety stop state) when the safety circuit and safety diagnosis circuit are operating correctly and when terminals H1-HC and H2-HC are OFF (Open).</p> <p>ON : Safety circuit fault or RUN/READY OFF : Safety stop state</p>	884

11.10 H: Terminal Functions

Setting Value	Function	Description	Ref.
122	!Mechanical Weakening Detection	V/f CL-V/f OLV CLV AOLV OLV/PM AOLV/PM CLV/PM EZOLV The terminal deactivates when the drive detects mechanical weakening.	884
12F	!Maintenance Notification	V/f CL-V/f OLV CLV AOLV OLV/PM AOLV/PM CLV/PM EZOLV The terminal deactivates when drive components are at their estimated maintenance period. Tells you about the maintenance period for these items: <ul style="list-style-type: none"> • IGBT • Cooling Fan • Capacitor • Soft charge bypass relay 	884
130	!During Torque Limit	V/f CL-V/f OLV CLV AOLV OLV/PM AOLV/PM CLV/PM EZOLV The terminal deactivates when the torque reference is the torque limit set with <i>L7 parameters, H3-02, H3-06, or H3-10 [MFAI Function Selection]</i> .	884
131	!During Speed Limit	V/f CL-V/f OLV CLV AOLV OLV/PM AOLV/PM CLV/PM EZOLV The terminal deactivates when the speed limit is active.	884
132	!In Speed Limit During Trq Ctrl	V/f CL-V/f OLV CLV AOLV OLV/PM AOLV/PM CLV/PM EZOLV The motor accelerates in the forward direction or the reverse direction after enabling torque control and the externally-input torque reference is disproportionate to the load. The output terminal deactivates when this speed is not higher than a constant speed and the motor speed is at the speed limit. This does not include operation when the drive is stopped.	884
133	!Zero Servo Complete	V/f CL-V/f OLV CLV AOLV OLV/PM AOLV/PM CLV/PM EZOLV The terminal deactivates when positioning in the range set with <i>b9-02 [Zero Servo Completion Window]</i> completes after sending the Zero-Servo command.	884
137	!During Frequency Output	V/f CL-V/f OLV CLV AOLV OLV/PM AOLV/PM CLV/PM EZOLV The terminal deactivates when the drive outputs frequency. ON : The drive is not outputting frequency. OFF : The drive is outputting frequency.	884
138	!Drive Enabled	V/f CL-V/f OLV CLV AOLV OLV/PM AOLV/PM CLV/PM EZOLV This terminal deactivates when the <i>H1-xx = 16A [Drive Enable]</i> terminal deactivates.	884
139	!Watt Hour Pulse Output	V/f CL-V/f OLV CLV AOLV OLV/PM AOLV/PM CLV/PM EZOLV Outputs the pulse that shows the watt hours.	884
13C	!LOCAL Control Selected	V/f CL-V/f OLV CLV AOLV OLV/PM AOLV/PM CLV/PM EZOLV The terminal deactivates when the Run command source or frequency reference source is LOCAL. ON : REMOTE OFF : LOCAL	884
13D	!During Speed Search	V/f CL-V/f OLV CLV AOLV OLV/PM AOLV/PM CLV/PM EZOLV The terminal deactivates when the drive does speed search.	884
13E	!PID Feedback Low	V/f CL-V/f OLV CLV AOLV OLV/PM AOLV/PM CLV/PM EZOLV The terminal deactivates when the drive detects <i>FbL [PID Feedback Loss]</i> .	884
13F	!PID Feedback High	V/f CL-V/f OLV CLV AOLV OLV/PM AOLV/PM CLV/PM EZOLV The terminal deactivates when the drive detects <i>FbH [Excessive PID Feedback]</i> .	884
14A	!During KEB Ride-Thru	V/f CL-V/f OLV CLV AOLV OLV/PM AOLV/PM CLV/PM EZOLV The terminal deactivates when the drive executes the KEB Ride-Thru function.	884
14B	!During Short Circuit Braking	V/f CL-V/f OLV CLV AOLV OLV/PM AOLV/PM CLV/PM EZOLV The terminal deactivates during Short Circuit Braking. Note: When <i>A1-02 = 8 [Control Method Selection = EZ Vector Control]</i> , this function is available when you use a PM motor.	884
14C	!During Fast Stop	V/f CL-V/f OLV CLV AOLV OLV/PM AOLV/PM CLV/PM EZOLV The terminal deactivates when the fast stop is in operation.	884
14D	!oH Pre-Alarm Reduction Limit	V/f CL-V/f OLV CLV AOLV OLV/PM AOLV/PM CLV/PM EZOLV The terminal deactivates when <i>L8-03 = 4 [Overheat Pre-Alarm Selection = Operate at Reduced Speed (L8-19)]</i> and <i>oH [Heatsink Overheat]</i> does not clear after the drive decreases the frequency for 10 cycles.	884
14E	!Braking Transistor Fault (rr)	V/f CL-V/f OLV CLV AOLV OLV/PM AOLV/PM CLV/PM EZOLV The terminal deactivates when the internal braking transistor overheats and the drive detects an <i>rr [Dynamic Braking Transistor Fault]</i> fault.	884
14F	!Braking Resistor Overheat (rH)	V/f CL-V/f OLV CLV AOLV OLV/PM AOLV/PM CLV/PM EZOLV The terminal deactivates when the braking resistor overheats and the drive detects an <i>rH [Braking Resistor Overheat]</i> fault.	884
160	!Internal Cooling Fan Failure	V/f CL-V/f OLV CLV AOLV OLV/PM AOLV/PM CLV/PM EZOLV The terminal deactivates when the drive detects a cooling fan failure in the drive.	884
161	!RotorPositionDetection Complete	V/f CL-V/f OLV CLV AOLV OLV/PM AOLV/PM CLV/PM EZOLV The terminal deactivates when drive receives a Run command and the drive detects the motor magnetic pole position of the PM motor.	884

Setting Value	Function	Description	Ref.
162	!Modbus Reg 1 Status Satisfied	V/f CL-V/f OLV CLV AOLV OLV/PM AOLV/PM CLV/PM EZOLV The terminal deactivates when the bit specified by H2-07 turns on regarding the MEMOBUS register address configured with H2-08.	884
163	!Modbus Reg 2 Status Satisfied	V/f CL-V/f OLV CLV AOLV OLV/PM AOLV/PM CLV/PM EZOLV The terminal deactivates when the bit specified by H2-10 turns on regarding the MEMOBUS register address configured with H2-09.	884
165	!Standby Output	V/f CL-V/f OLV CLV AOLV OLV/PM AOLV/PM CLV/PM EZOLV The terminal activated after the drive stops operating and after the time set with b8-51 [Standby Mode Wait Time]. ON : The Run command turns off and the drive stops operating. When time set in b8-51 [Standby Mode Wait Time] is expired, the magnetic contactor on the input side turns off. OFF : The Run command turns on and the magnetic contactor on the input side turns on.	884
166	!Comparator 1	V/f CL-V/f OLV CLV AOLV OLV/PM AOLV/PM CLV/PM EZOLV The terminal deactivates when the monitor value set with H2-20 is within range of H2-21 and H2-22 for the time set in H2-24.	884
167	!Comparator 2	V/f CL-V/f OLV CLV AOLV OLV/PM AOLV/PM CLV/PM EZOLV The terminal deactivates when the when the monitor value set with H2-26 is outside the range of H2-27 and H2-28 for the time set in H2-30.	884
169	!External Power 24V Supply	V/f CL-V/f OLV CLV AOLV OLV/PM AOLV/PM CLV/PM EZOLV The terminal deactivates when there is an external 24V power supply between terminals PS-AC. ON : The external 24V power supply is not supplying power. OFF : The external 24V power supply is supplying power.	884
16A	!Data Logger Error	V/f CL-V/f OLV CLV AOLV OLV/PM AOLV/PM CLV/PM EZOLV The terminal deactivates when the drive detects a LoG [Com Error / Abnormal SD card].	884
190	!DWEZ Digital Output 1	V/f CL-V/f OLV CLV AOLV OLV/PM AOLV/PM CLV/PM EZOLV Sets the DriveWorksEZ digital output 1. Refer to the DriveWorksEZ online manual for more information.	884
191	!DWEZ Digital Output 2	V/f CL-V/f OLV CLV AOLV OLV/PM AOLV/PM CLV/PM EZOLV Sets the DriveWorksEZ digital output 2. Refer to the DriveWorksEZ online manual for more information.	884
192	!DWEZ Digital Output 3	V/f CL-V/f OLV CLV AOLV OLV/PM AOLV/PM CLV/PM EZOLV Sets the DriveWorksEZ digital output 3. Refer to the DriveWorksEZ online manual for more information.	884
193	!DWEZ Digital Output 4	V/f CL-V/f OLV CLV AOLV OLV/PM AOLV/PM CLV/PM EZOLV Sets the DriveWorksEZ digital output 4. Refer to the DriveWorksEZ online manual for more information.	884
1A0	!DWEZ Extended Digital Output 1	V/f CL-V/f OLV CLV AOLV OLV/PM AOLV/PM CLV/PM EZOLV Sets the digital output 1 for the DriveWorksEZ DO-A3 option. Refer to the DriveWorksEZ online manual for more information.	884
1A1	!DWEZ Extended Digital Output 2	V/f CL-V/f OLV CLV AOLV OLV/PM AOLV/PM CLV/PM EZOLV Sets the digital output 2 for the DriveWorksEZ DO-A3 option. Refer to the DriveWorksEZ online manual for more information.	884
1A2	!DWEZ Extended Digital Output 3	V/f CL-V/f OLV CLV AOLV OLV/PM AOLV/PM CLV/PM EZOLV Sets the digital output 3 for the DriveWorksEZ DO-A3 option. Refer to the DriveWorksEZ online manual for more information.	884
1A3	!DWEZ Extended Digital Output 4	V/f CL-V/f OLV CLV AOLV OLV/PM AOLV/PM CLV/PM EZOLV Sets the digital output 4 for the DriveWorksEZ DO-A3 option. Refer to the DriveWorksEZ online manual for more information.	884
1A4	!DWEZ Extended Digital Output 5	V/f CL-V/f OLV CLV AOLV OLV/PM AOLV/PM CLV/PM EZOLV Sets the digital output 5 for the DriveWorksEZ DO-A3 option. Refer to the DriveWorksEZ online manual for more information.	884
1A5	!DWEZ Extended Digital Output 6	V/f CL-V/f OLV CLV AOLV OLV/PM AOLV/PM CLV/PM EZOLV Sets the digital output 6 for the DriveWorksEZ DO-A3 option. Refer to the DriveWorksEZ online manual for more information.	884
1A6	!DWEZ Extended Digital Output 7	V/f CL-V/f OLV CLV AOLV OLV/PM AOLV/PM CLV/PM EZOLV Sets the digital output 7 for the DriveWorksEZ DO-A3 option. Refer to the DriveWorksEZ online manual for more information.	884
1A7	!DWEZ Extended Digital Output 8	V/f CL-V/f OLV CLV AOLV OLV/PM AOLV/PM CLV/PM EZOLV Sets the digital output 8 for the DriveWorksEZ DO-A3 option. Refer to the DriveWorksEZ online manual for more information.	884

◆ H3: Analog Inputs

No. (Hex.)	Name	Description	Default (Range)	Ref.
H3-01 (0410)	Terminal A1 Signal Level Select	<p>V/f CL-V/f OLV CLV AOLV OLV/PM AOLV/PM CLV/PM EZOLV</p> <p>Sets the input signal level for MFAI terminal A1. 0 : 0-10V (Lower Limit at 0) 1 : -10 to +10V (Bipolar Reference) 2 : 4 to 20 mA 3 : 0 to 20 mA</p>	0 (0 - 3)	886
H3-02 (0434)	Terminal A1 Function Selection	<p>V/f CL-V/f OLV CLV AOLV OLV/PM AOLV/PM CLV/PM EZOLV</p> <p>Sets the function for MFAI terminal A1.</p>	0 (0 - 32)	886
H3-03 (0411) RUN	Terminal A1 Gain Setting	<p>V/f CL-V/f OLV CLV AOLV OLV/PM AOLV/PM CLV/PM EZOLV</p> <p>Sets the gain of the analog signal input to MFAI terminal A1.</p>	100.0% (-999.9 - +999.9%)	886
H3-04 (0412) RUN	Terminal A1 Bias Setting	<p>V/f CL-V/f OLV CLV AOLV OLV/PM AOLV/PM CLV/PM EZOLV</p> <p>Sets the bias of the analog signal input to MFAI terminal A1.</p>	0.0% (-999.9 - +999.9%)	887
H3-05 (0413)	Terminal A3 Signal Level Select	<p>V/f CL-V/f OLV CLV AOLV OLV/PM AOLV/PM CLV/PM EZOLV</p> <p>Sets the input signal level for MFAI terminal A3. 0 : 0-10V (Lower Limit at 0) 1 : -10 to +10V (Bipolar Reference) 2 : 4 to 20 mA 3 : 0 to 20 mA</p>	0 (0 - 3)	887
H3-06 (0414)	Terminal A3 Function Selection	<p>V/f CL-V/f OLV CLV AOLV OLV/PM AOLV/PM CLV/PM EZOLV</p> <p>Sets the function for MFAI terminal A3.</p>	2 (0 - 32)	887
H3-07 (0415) RUN	Terminal A3 Gain Setting	<p>V/f CL-V/f OLV CLV AOLV OLV/PM AOLV/PM CLV/PM EZOLV</p> <p>Sets the gain of the analog signal input to MFAI terminal A3.</p>	100.0% (-999.9 - +999.9%)	887
H3-08 (0416) RUN	Terminal A3 Bias Setting	<p>V/f CL-V/f OLV CLV AOLV OLV/PM AOLV/PM CLV/PM EZOLV</p> <p>Sets the bias of the analog signal input to MFAI terminal A3.</p>	0.0% (-999.9 - +999.9%)	888
H3-09 (0417)	Terminal A2 Signal Level Select	<p>V/f CL-V/f OLV CLV AOLV OLV/PM AOLV/PM CLV/PM EZOLV</p> <p>Sets the input signal level for MFAI terminal A2. 0 : 0-10V (Lower Limit at 0) 1 : -10 to +10V (Bipolar Reference) 2 : 4 to 20 mA 3 : 0 to 20 mA</p>	2 (0 - 3)	888
H3-10 (0418)	Terminal A2 Function Selection	<p>V/f CL-V/f OLV CLV AOLV OLV/PM AOLV/PM CLV/PM EZOLV</p> <p>Sets the function for MFAI terminal A2.</p>	0 (0 - 32)	888
H3-11 (0419) RUN	Terminal A2 Gain Setting	<p>V/f CL-V/f OLV CLV AOLV OLV/PM AOLV/PM CLV/PM EZOLV</p> <p>Sets the gain of the analog signal input to MFAI terminal A2.</p>	100.0% (-999.9 - +999.9%)	888
H3-12 (041A) RUN	Terminal A2 Bias Setting	<p>V/f CL-V/f OLV CLV AOLV OLV/PM AOLV/PM CLV/PM EZOLV</p> <p>Sets the bias of the analog signal input to MFAI terminal A2.</p>	0.0% (-999.9 - +999.9%)	889
H3-13 (041B)	Analog Input Filter Time Constant	<p>V/f CL-V/f OLV CLV AOLV OLV/PM AOLV/PM CLV/PM EZOLV</p> <p>Sets the time constant for primary delay filters on MFAI terminals.</p>	0.03 s (0.00 - 2.00 s)	889
H3-14 (041C)	Analog Input Terminal Enable Sel	<p>V/f CL-V/f OLV CLV AOLV OLV/PM AOLV/PM CLV/PM EZOLV</p> <p>Sets the enabled terminal or terminals when $H1-xx = C$ [MFDI Function Select = Analog Terminal Enable Selection] is ON. 1 : Terminal A1 only 2 : Terminal A2 only 3 : Terminals A1 and A2 4 : Terminal A3 only 5 : Terminals A1 and A3 6 : Terminals A2 and A3 7 : Terminals A1, A2, and A3</p>	7 (1 - 7)	889
H3-16 (02F0)	Terminal A1 Offset	<p>V/f CL-V/f OLV CLV AOLV OLV/PM AOLV/PM CLV/PM EZOLV</p> <p>Sets the offset level for analog signals input to terminal A1. Usually it is not necessary to change this setting.</p>	0 (-500 - +500)	889
H3-17 (02F1)	Terminal A2 Offset	<p>V/f CL-V/f OLV CLV AOLV OLV/PM AOLV/PM CLV/PM EZOLV</p> <p>Sets the offset level for analog signals input to terminal A2. Usually it is not necessary to change this setting.</p>	0 (-500 - +500)	889

No. (Hex.)	Name	Description	Default (Range)	Ref.
H3-18 (02F2)	Terminal A3 Offset	V/f CL-V/f OLV CLV AOLV OLV/PM AOLV/PM CLV/PM EZOLV Sets the offset level for analog signals input to terminal A3. Usually it is not necessary to change this setting.	0 (-500 - +500)	890
H3-40 (0B5C)	Mbus Reg 15C1h Input Function	V/f CL-V/f OLV CLV AOLV OLV/PM AOLV/PM CLV/PM EZOLV Sets the MEMOBUS AI1 function.	F (4 - 2F)	890
H3-41 (0B5F)	Mbus Reg 15C2h Input Function	V/f CL-V/f OLV CLV AOLV OLV/PM AOLV/PM CLV/PM EZOLV Sets the MEMOBUS AI2 function.	F (4 - 2F)	890
H3-42 (0B62)	Mbus Reg 15C3h Input Function	V/f CL-V/f OLV CLV AOLV OLV/PM AOLV/PM CLV/PM EZOLV Sets the MEMOBUS AI3 function.	F (4 - 2F)	890
H3-43 (117F)	Mbus Reg Inputs FilterTime Const	V/f CL-V/f OLV CLV AOLV OLV/PM AOLV/PM CLV/PM EZOLV Sets the time constant to apply a primary delay filter to the MEMOBUS analog input register values.	0.00 s (0.00 - 2.00 s)	890

■ H3-xx: MFAI Function Selections

Setting Value	Function	Description	Ref.
0	Frequency Reference	V/f CL-V/f OLV CLV AOLV OLV/PM AOLV/PM CLV/PM EZOLV The input value from the MFAI terminal set with this function becomes the master frequency reference.	890
1	Frequency Gain	V/f CL-V/f OLV CLV AOLV OLV/PM AOLV/PM CLV/PM EZOLV The drive multiplies the analog frequency reference with the input value from the MFAI set with this function.	891
2	Auxiliary Frequency Reference 1	V/f CL-V/f OLV CLV AOLV OLV/PM AOLV/PM CLV/PM EZOLV Sets Reference 2 through multi-step speed reference to enable the command reference (Auxiliary Frequency Reference 1) from the analog input terminal set here. This value is a percentage where the Maximum Output Frequency setting is a setting value of 100%. Note: Parameter A1-02 [Control Method Selection] selects which parameter is the maximum output frequency. • A1-02 ≠ 8 [EZOLV]: E1-04 [Maximum Output Frequency] • A1-02 = 8: E9-02 [Maximum Speed]	891
3	Auxiliary Frequency Reference 2	V/f CL-V/f OLV CLV AOLV OLV/PM AOLV/PM CLV/PM EZOLV Sets Reference 3 through multi-step speed reference to enable the command reference (Auxiliary Frequency Reference 2) from the analog input terminal set here. This value is a percentage where the Maximum Output Frequency setting is a setting value of 100%. Note: Parameter A1-02 [Control Method Selection] selects which parameter is the maximum output frequency. • A1-02 ≠ 8 [EZOLV]: E1-04 [Maximum Output Frequency] • A1-02 = 8: E9-02 [Maximum Speed]	891
4	Output Voltage Bias	V/f CL-V/f OLV CLV AOLV OLV/PM AOLV/PM CLV/PM EZOLV Set this parameter to input a bias signal and amplify the output voltage.	891
5	Accel/Decel Time Gain	V/f CL-V/f OLV CLV AOLV OLV/PM AOLV/PM CLV/PM EZOLV Enters a signal to adjust the gain used for C1-01 to C1-08 [Acceleration/Deceleration Times 1 to 4] and C1-09 [Fast Stop Time] when the full scale analog signal (10 V or 20 mA) is 100%.	892
6	DC Injection Braking Current	V/f CL-V/f OLV CLV AOLV OLV/PM AOLV/PM CLV/PM EZOLV Enters a signal to adjust the current level used for DC Injection Braking when the drive rated output current is 100%.	892
7	Torque Detection Level	V/f CL-V/f OLV CLV AOLV OLV/PM AOLV/PM CLV/PM EZOLV Enters a signal to adjust the overtorque/undertorque detection level. Note: Use this function with L6-01 [Torque Detection Selection 1]. This parameter functions as an alternative to L6-02 [Torque Detection Level 1].	892
8	Stall Prevent Level During Run	V/f CL-V/f OLV CLV AOLV OLV/PM AOLV/PM CLV/PM EZOLV Enters a signal to adjust the stall prevention level during run if the drive rated current is 100%.	892
9	Output Frequency Lower Limit	V/f CL-V/f OLV CLV AOLV OLV/PM AOLV/PM CLV/PM EZOLV Enters a signal to adjust the output frequency lower limit level as a percentage of the maximum output frequency. Note: Parameter A1-02 [Control Method Selection] selects which parameter is the maximum output frequency. • A1-02 ≠ 8 [EZOLV]: E1-04 [Maximum Output Frequency] • A1-02 = 8: E9-02 [Maximum Speed]	893
B	PID Feedback	V/f CL-V/f OLV CLV AOLV OLV/PM AOLV/PM CLV/PM EZOLV Enter the PID feedback value as a percentage of the maximum output frequency. Note: Parameter A1-02 [Control Method Selection] selects which parameter is the maximum output frequency. • A1-02 ≠ 8 [EZOLV]: E1-04 [Maximum Output Frequency] • A1-02 = 8: E9-02 [Maximum Speed]	893

11.10 H: Terminal Functions

Setting Value	Function	Description	Ref.
C	PID Setpoint	<p>V/f CL-V/f OLV CLV AOLV OLV/PM AOLV/PM CLV/PM EZOLV</p> <p>Enters the PID setpoint as a percentage of the maximum output frequency.</p> <p>Note: Parameter <i>A1-02 [Control Method Selection]</i> selects which parameter is the maximum output frequency. • <i>A1-02 ≠ 8 [EZOLV]: E1-04 [Maximum Output Frequency]</i> • <i>A1-02 = 8: E9-02 [Maximum Speed]</i></p>	893
D	Frequency Bias	<p>V/f CL-V/f OLV CLV AOLV OLV/PM AOLV/PM CLV/PM EZOLV</p> <p>Enters the bias value added to the frequency reference as a percentage of the maximum output frequency.</p> <p>Note: Parameter <i>A1-02 [Control Method Selection]</i> selects which parameter is the maximum output frequency. • <i>A1-02 ≠ 8 [EZOLV]: E1-04 [Maximum Output Frequency]</i> • <i>A1-02 = 8: E9-02 [Maximum Speed]</i></p>	893
E	Motor Temperature (PTC Input)	<p>V/f CL-V/f OLV CLV AOLV OLV/PM AOLV/PM CLV/PM EZOLV</p> <p>Uses the motor Positive Temperature Coefficient (PTC) thermistor to prevent heat damage to the motor as a percentage of the current value when the 10 V analog signal is input.</p>	893
F	Not Used	<p>V/f CL-V/f OLV CLV AOLV OLV/PM AOLV/PM CLV/PM EZOLV</p> <p>Use this setting for unused terminals or to use terminals in through mode.</p>	894
10	Forward Torque Limit	<p>V/f CL-V/f OLV CLV AOLV OLV/PM AOLV/PM CLV/PM EZOLV</p> <p>Enters the forward torque limit if the motor rated torque is 100%.</p>	894
11	Reverse Torque Limit	<p>V/f CL-V/f OLV CLV AOLV OLV/PM AOLV/PM CLV/PM EZOLV</p> <p>Enters the load torque limit if the motor rated torque is 100%.</p>	895
12	Regenerative Torque Limit	<p>V/f CL-V/f OLV CLV AOLV OLV/PM AOLV/PM CLV/PM EZOLV</p> <p>Enters the regenerative torque limit if the motor rated torque is 100%.</p>	895
13	Torque Reference / Torque Limit	<p>V/f CL-V/f OLV CLV AOLV OLV/PM AOLV/PM CLV/PM EZOLV</p> <p>Enters the torque reference if the motor rated torque is 100%. This setting is the torque limit for speed control.</p>	895
14	Torque Compensation	<p>V/f CL-V/f OLV CLV AOLV OLV/PM AOLV/PM CLV/PM EZOLV</p> <p>Enters the torque compensation value if the motor rated torque is 100%.</p>	895
15	General Torque Limit	<p>V/f CL-V/f OLV CLV AOLV OLV/PM AOLV/PM CLV/PM EZOLV</p> <p>Enters the torque limit that is the same for all quadrants for forward, reverse, and regenerative operation if the motor rated torque is 100%.</p>	895
16	Differential PID Feedback	<p>V/f CL-V/f OLV CLV AOLV OLV/PM AOLV/PM CLV/PM EZOLV</p> <p>Enters the PID differential feedback value if the full scale analog signal (10 V or 20 mA) is 100%.</p>	895
1F	Not Used	<p>V/f CL-V/f OLV CLV AOLV OLV/PM AOLV/PM CLV/PM EZOLV</p> <p>Use this setting for unused terminals or to use terminals in through mode.</p>	896
30	DWEZ Analog Input 1	<p>V/f CL-V/f OLV CLV AOLV OLV/PM AOLV/PM CLV/PM EZOLV</p> <p>Use with DriveWorksEZ. Refer to the DriveWorksEZ online manual for more information.</p>	896
31	DWEZ Analog Input 2	<p>V/f CL-V/f OLV CLV AOLV OLV/PM AOLV/PM CLV/PM EZOLV</p> <p>Use with DriveWorksEZ. Refer to the DriveWorksEZ online manual for more information.</p>	896
32	DWEZ Analog Input 3	<p>V/f CL-V/f OLV CLV AOLV OLV/PM AOLV/PM CLV/PM EZOLV</p> <p>Use with DriveWorksEZ. Refer to the DriveWorksEZ online manual for more information.</p>	896

◆ H4: Analog Outputs

No. (Hex.)	Name	Description	Default (Range)	Ref.
H4-01 (041D)	Terminal FM Analog Output Select	<p>V/f CL-V/f OLV CLV AOLV OLV/PM AOLV/PM CLV/PM EZOLV</p> <p>Sets the monitoring number (<i>Ux-xx</i>) to be output from MFAO terminal FM.</p> <p>Note: Set the <i>x-xx</i> part of the <i>Ux-xx [Monitors]</i>. For example, set <i>H4-01 = 102</i> to monitor <i>U1-02 [Output Frequency]</i>. If the <i>x</i> part of <i>Ux</i> is a letter, replace the letter (hexadecimal number) with a decimal number. For example, set <i>H4-01 = 1301</i> to monitor <i>Ud-01</i>.</p>	102 (000 - 9999)	897
H4-02 (041E) RUN	Terminal FM Analog Output Gain	<p>V/f CL-V/f OLV CLV AOLV OLV/PM AOLV/PM CLV/PM EZOLV</p> <p>Sets the gain of the monitor signal that is sent from MFAO terminal FM.</p> <p>Sets the analog signal output level from the terminal FM at 10 V or 20 mA as 100% when an output for monitoring items is 100%.</p>	100.0% (-999.9 - +999.9%)	898
H4-03 (041F) RUN	Terminal FM Analog Output Bias	<p>V/f CL-V/f OLV CLV AOLV OLV/PM AOLV/PM CLV/PM EZOLV</p> <p>Sets the bias of the monitor signal that is sent from MFAO terminal FM.</p> <p>Set the level of the analog signal sent from terminal FM at 10 V or 20 mA as 100% when an output for monitoring items is 0%.</p>	0.0% (-999.9 - +999.9%)	898

No. (Hex.)	Name	Description	Default (Range)	Ref.
H4-04 (0420)	Terminal AM Analog Output Select	<p>V/f CL-V/f OLV CLV AOLV OLV/PM AOLV/PM CLV/PM EZOLV</p> <p>Sets the monitoring number ($Ux-xx$) to be output from MFAO terminal AM.</p> <p>Note: Set the $x-xx$ part of the $Ux-xx$ [Monitor]. For example, set $H4-04 = 103$ to monitor $U1-03$ [Output Current]. If the x part of Ux is a letter, replace the letter (hexadecimal number) with a decimal number. For example, set $H4-04 = 1301$ to monitor $Ud-01$.</p>	103 (000 - 9999)	898
H4-05 (0421) RUN	Terminal AM Analog Output Gain	<p>V/f CL-V/f OLV CLV AOLV OLV/PM AOLV/PM CLV/PM EZOLV</p> <p>Sets the gain of the monitor signal that is sent from MFAO terminal AM.</p> <p>When an output for monitoring items is 0%, this parameter sets the analog signal output level from the AM terminal at 10 V or 20 mA as 100%.</p>	50.0% (-999.9 - +999.9%)	898
H4-06 (0422) RUN	Terminal AM Analog Output Bias	<p>V/f CL-V/f OLV CLV AOLV OLV/PM AOLV/PM CLV/PM EZOLV</p> <p>Sets the bias of the monitor signal that is sent from MFAO terminal AM.</p> <p>When an output for monitoring items is 0%, this parameter sets the analog signal output level from the AM terminal at 10 V or 20 mA as 0%.</p>	0.0% (-999.9 - +999.9%)	899
H4-07 (0423)	Terminal FM Signal Level Select	<p>V/f CL-V/f OLV CLV AOLV OLV/PM AOLV/PM CLV/PM EZOLV</p> <p>Sets the MFAO terminal FM output signal level.</p> <p>Note: Set jumper S5 on the control circuit terminal block accordingly when changing these parameters. 0 : 0-10V (Lower Limit at 0) 1 : -10 to +10V (Bipolar Reference) 2 : 4 to 20 mA</p>	0 (0 - 2)	899
H4-08 (0424)	Terminal AM Signal Level Select	<p>V/f CL-V/f OLV CLV AOLV OLV/PM AOLV/PM CLV/PM EZOLV</p> <p>Sets the MFAO terminal AM output signal level.</p> <p>Note: Set jumper S5 on the control circuit terminal block accordingly when changing these parameters. 0 : 0 to 10 Vdc 1 : -10 to +10 Vdc 2 : 4 to 20 mA</p>	0 (0 - 2)	899
H4-20 (0B53)	Analog Power Monitor 100% Level	<p>V/f CL-V/f OLV CLV AOLV OLV/PM AOLV/PM CLV/PM EZOLV</p> <p>Sets the level at 10 V when $U1-08$ [Output Power] is set for analog output.</p> <p>Note: On drive models 2xxx, and 4002 to 4675, the setting unit is 0.01 kW. The setting range is 0.00 kW to 650.00 kW. On drive models 4810 to 4H12, the setting unit is 0.1 kW. The setting range is 0.0 kW to 1000.0 kW.</p>	0.00 kW (0.00 - 1000.0 kW)	899

◆ H5: Modbus Communication

No. (Hex.)	Name	Description	Default (Range)	Ref.
H5-01 (0425)	Drive Node Address	<p>V/f CL-V/f OLV CLV AOLV OLV/PM AOLV/PM CLV/PM EZOLV</p> <p>Sets the communication slave address for drives.</p> <p>Note: • Re-energize the drive or set $H5-20 = 1$ [Communication Parameters Reload = Reload Now] after you change the parameter setting. • Setting 0 will not let the drive respond to MEMOBUS/Modbus communications.</p>	1FH (0 - FFH)	900
H5-02 (0426)	Communication Speed Selection	<p>V/f CL-V/f OLV CLV AOLV OLV/PM AOLV/PM CLV/PM EZOLV</p> <p>Sets the communications speed for MEMOBUS/Modbus communications.</p> <p>Note: Re-energize the drive or set $H5-20 = 1$ [Communication Parameters Reload = Reload Now] after you change the parameter setting.</p> <p>0 : 1200 bps 1 : 2400 bps 2 : 4800 bps 3 : 9600 bps 4 : 19.2 kbps 5 : 38.4 kbps 6 : 57.6 kbps 7 : 76.8 kbps 8 : 115.2 kbps</p>	3 (0 - 8)	900
H5-03 (0427)	Communication Parity Selection	<p>V/f CL-V/f OLV CLV AOLV OLV/PM AOLV/PM CLV/PM EZOLV</p> <p>Sets the communications parity used for MEMOBUS/Modbus communications.</p> <p>Note: Re-energize the drive or set $H5-20 = 1$ [Communication Parameters Reload = Reload Now] after you change the parameter setting.</p> <p>0 : No parity 1 : Even parity 2 : Odd parity</p>	0 (0 - 2)	900

11.10 H: Terminal Functions

No. (Hex.)	Name	Description	Default (Range)	Ref.
H5-04 (0428)	Communication Error Stop Method	<p>V/f CL-V/f OLV CLV AOLV OLV/PM AOLV/PM CLV/PM EZOLV</p> <p>Sets the motor Stopping Method when the drive detects <i>CE [Modbus Communication Error]</i> issues.</p> <p>0 : Ramp to Stop 1 : Coast to Stop 2 : Fast Stop (Use C1-09) 3 : Alarm Only</p>	3 (0 - 3)	900
H5-05 (0429)	Comm Fault Detection Selection	<p>V/f CL-V/f OLV CLV AOLV OLV/PM AOLV/PM CLV/PM EZOLV</p> <p>Sets the function that detects <i>CE [Modbus Communication Error]</i> issues during MEMOBUS/Modbus communications.</p> <p>0 : Disabled 1 : Enabled</p>	1 (0, 1)	901
H5-06 (042A)	Drive Transmit Wait Time	<p>V/f CL-V/f OLV CLV AOLV OLV/PM AOLV/PM CLV/PM EZOLV</p> <p>Sets the time to wait to send a response message after the drive receives a command message from the master.</p> <p>Note: Restart the drive after changing the parameter setting.</p>	5 ms (0 - 65 ms)	901
H5-09 (0435)	CE Detection Time	<p>V/f CL-V/f OLV CLV AOLV OLV/PM AOLV/PM CLV/PM EZOLV</p> <p>Sets the detection time for <i>CE [Modbus Communication Error]</i> issues when communication stops.</p>	2.0 s (0.0 - 10.0 s)	901
H5-10 (0436)	Modbus Register 0025H Unit Sel	<p>V/f CL-V/f OLV CLV AOLV OLV/PM AOLV/PM CLV/PM EZOLV</p> <p>Sets the unit of measure used for the MEMOBUS/Modbus communications monitor register 0025H (output voltage reference monitor).</p> <p>0 : 0.1 V units 1 : 1 V units</p>	0 (0, 1)	901
H5-11 (043C)	Comm ENTER Command Mode	<p>V/f CL-V/f OLV CLV AOLV OLV/PM AOLV/PM CLV/PM EZOLV</p> <p>Sets the function to make the Enter command necessary to change parameters through MEMOBUS/Modbus communications.</p> <p>0 : ENTER Command Required 1 : ENTER Command Not Required</p>	0 (0, 1)	901
H5-12 (043D)	Run Command Method Selection	<p>V/f CL-V/f OLV CLV AOLV OLV/PM AOLV/PM CLV/PM EZOLV</p> <p>Sets the input method for the Run command when <i>b1-02 = 2 [Run Command Selection 1 = Memobus/Modbus Communications]</i> or <i>b1-16 = 2 [Run Command Selection 2 = Memobus/Modbus Communications]</i>.</p> <p>0 : FWD/Stop, REV/Stop 1 : Run/Stop, FWD/REV</p>	0 (0, 1)	902
H5-17 (11A1) Expert	ENTER command response @CPU BUSY	<p>V/f CL-V/f OLV CLV AOLV OLV/PM AOLV/PM CLV/PM EZOLV</p> <p>Sets operation when the EEPROM write command is sent without EEPROM write available. Usually it is not necessary to change this setting.</p> <p>0 : Ignore Command(No ROM/RAM Write) 1 : Write to RAM Only</p>	0 (0, 1)	902
H5-18 (11A2)	Motor Speed Filter over Comms	<p>V/f CL-V/f OLV CLV AOLV OLV/PM AOLV/PM CLV/PM EZOLV</p> <p>Sets the filter time constant used when monitoring motor speed during MEMOBUS/Modbus communications or with a communication option.</p>	0 ms (0 - 100 ms)	902
H5-20 (0B57)	Communication Parameters Reload	<p>V/f CL-V/f OLV CLV AOLV OLV/PM AOLV/PM CLV/PM EZOLV</p> <p>Sets the function to immediately enable updated MEMOBUS/Modbus communications parameters.</p> <p>0 : Reload at Next Power Cycle 1 : Reload Now</p>	0 (0, 1)	902
H5-22 (11CF)	Speed Search from MODBUS	<p>V/f CL-V/f OLV CLV AOLV OLV/PM AOLV/PM CLV/PM EZOLV</p> <p>Enables the MEMOBUS/Modbus communication register Speed Search function (bit0 of 15DFH).</p> <p>0 : Disabled 1 : Enabled</p>	0 (0, 1)	903
H5-25 (1589) RUN	Function 5A Register 1 Selection	<p>V/f CL-V/f OLV CLV AOLV OLV/PM AOLV/PM CLV/PM EZOLV</p> <p>Returns the contents of the specified MEMOBUS/Modbus communications register when responding to the master device.</p>	0044H (U1-05) (0000H - FFFFH)	903
H5-26 (158A) RUN	Function 5A Register 2 Selection	<p>V/f CL-V/f OLV CLV AOLV OLV/PM AOLV/PM CLV/PM EZOLV</p> <p>Returns the contents of the specified MEMOBUS/Modbus communications register when responding to the master device.</p>	0045H (U1-06) (0000H - FFFFH)	903
H5-27 (158B) RUN	Function 5A Register 3 Selection	<p>V/f CL-V/f OLV CLV AOLV OLV/PM AOLV/PM CLV/PM EZOLV</p> <p>Returns the contents of the specified MEMOBUS/Modbus communications register when responding to the master device.</p>	0042H (U1-03) (0000H - FFFFH)	903
H5-28 (158C) RUN	Function 5A Register 4 Selection	<p>V/f CL-V/f OLV CLV AOLV OLV/PM AOLV/PM CLV/PM EZOLV</p> <p>Returns the contents of the specified MEMOBUS/Modbus communications register when responding to the master device.</p>	0049H (U1-10) (0000H - FFFFH)	903

◆ H6: Pulse Train Input/Output

No. (Hex.)	Name	Description	Default (Range)	Ref.
H6-01 (042C)	Terminal RP Pulse Train Function	V/f CL-V/f OLV CLV AOLV OLV/PM AOLV/PM CLV/PM EZOLV Sets the function for pulse train input terminal RP. 0 : Frequency Reference 1 : PID Feedback Value 2 : PID Setpoint Value 3 : Speed Feedback (V/F Control)	0 (0 - 3)	904
H6-02 (042D) RUN	Terminal RP Frequency Scaling	V/f CL-V/f OLV CLV AOLV OLV/PM AOLV/PM CLV/PM EZOLV Sets the frequency of the pulse train input signal used when the item selected with H6-01 [Terminal RP Pulse Train Function] is input at 100%.	1440 Hz (100 - 32000 Hz)	905
H6-03 (042E) RUN	Terminal RP Function Gain	V/f CL-V/f OLV CLV AOLV OLV/PM AOLV/PM CLV/PM EZOLV Sets the gain used when the function in H6-01 [Terminal RP Pulse Train Function] is input to terminal RP.	100.0% (0.0 - 1000.0%)	905
H6-04 (042F) RUN	Terminal RP Function Bias	V/f CL-V/f OLV CLV AOLV OLV/PM AOLV/PM CLV/PM EZOLV Sets the bias used when the function in H6-01 [Terminal RP Pulse Train Function] is input to terminal RP. Sets a value at the time when the pulse train is 0 Hz.	0.0% (-100.0 - 100.0%)	905
H6-05 (0430) RUN	Terminal RP Filter Time	V/f CL-V/f OLV CLV AOLV OLV/PM AOLV/PM CLV/PM EZOLV Sets the time constant for the pulse train input primary delay filters.	0.10 s (0.00 - 2.00 s)	905
H6-06 (0431) RUN	Terminal MP Monitor Selection	V/f CL-V/f OLV CLV AOLV OLV/PM AOLV/PM CLV/PM EZOLV Sets a function for pulse train monitor output terminal MP. Sets the "x-xx" part of the Ux-xx monitor.	102 (000, 031, 101, 102, 105, 116, 501, 502, 801 - 809, 821 - 825, 831 - 839, 851 - 855)	905
H6-07 (0432) RUN	Terminal MP Frequency Scaling	V/f CL-V/f OLV CLV AOLV OLV/PM AOLV/PM CLV/PM EZOLV Sets the frequency of the pulse train output signal used when the monitor set with H6-06 [Terminal MP Monitor Selection] is 100%.	1440 Hz (0 - 32000 Hz)	906
H6-08 (043F)	Terminal RP Minimum Frequency	V/f CL-V/f OLV CLV AOLV OLV/PM AOLV/PM CLV/PM EZOLV Sets the minimum frequency of the pulse train signal that terminal RP can detect.	0.5 Hz (0.1 - 1000.0 Hz)	906
H6-09 (156E)	Voltage Phase Sync MP Selection	V/f CL-V/f OLV CLV AOLV OLV/PM AOLV/PM CLV/PM EZOLV Set whether to output the pulse synchronized with drive output voltage phase from the pulse train monitor output terminal MP. This parameter is only enabled when H6-06 = 102 [Terminal MP Monitor Selection = Output Frequency] and H6-07 = 0 [Terminal MP Frequency Scaling = 0 Hz]. 0 : Disabled 1 : Enabled	0 (0, 1)	906

◆ H7: Virtual MFIO selection

No. (Hex.)	Name	Description	Default (Range)	Ref.
H7-00 (116F) Expert	Virtual MFIO selection	V/f CL-V/f OLV CLV AOLV OLV/PM AOLV/PM CLV/PM EZOLV Sets the function to enable and disable the virtual I/O function. Set this parameter to 1 to operate the virtual I/O function. 0 : Disabled 1 : Enabled	0 (0, 1)	907
H7-01 (1185) Expert	Virtual Multi-Function Input 1	V/f CL-V/f OLV CLV AOLV OLV/PM AOLV/PM CLV/PM EZOLV Sets the function that enters the virtual input set in H7-10 [Virtual Multi-Function Output 1].	F (1 - 19F)	907
H7-02 (1186) Expert	Virtual Multi-Function Input 2	V/f CL-V/f OLV CLV AOLV OLV/PM AOLV/PM CLV/PM EZOLV Sets the function that enters the virtual input set in H7-12 [Virtual Multi-Function Output 2].	F (1 - 19F)	907
H7-03 (1187) Expert	Virtual Multi-Function Input 3	V/f CL-V/f OLV CLV AOLV OLV/PM AOLV/PM CLV/PM EZOLV Sets the function that enters the virtual input set in H7-14 [Virtual Multi-Function Output 3].	F (1 - 19F)	908
H7-04 (1188) Expert	Virtual Multi-Function Input 4	V/f CL-V/f OLV CLV AOLV OLV/PM AOLV/PM CLV/PM EZOLV Sets the function that enters the virtual input set in H7-16 [Virtual Multi-Function Output 4].	F (1 - 19F)	908
H7-10 (11A4) Expert	Virtual Multi-Function Output 1	V/f CL-V/f OLV CLV AOLV OLV/PM AOLV/PM CLV/PM EZOLV Sets the function for virtual digital output 1.	F (0 - 1A7)	908

11.10 H: Terminal Functions

No. (Hex.)	Name	Description	Default (Range)	Ref.
H7-11 (11A5) Expert	Virtual Output 1 Delay Time	V/f CL-V/f OLV CLV AOLV OLV/PM AOLV/PM CLV/PM EZOLV Sets the minimum ON time for virtual digital output 1.	0.1 s (0.0 - 25.0 s)	908
H7-12 (11A6) Expert	Virtual Multi-Function Output 2	V/f CL-V/f OLV CLV AOLV OLV/PM AOLV/PM CLV/PM EZOLV Sets the function for virtual digital output 2.	F (0 - 1A7)	908
H7-13 (11A7) Expert	Virtual Output 2 Delay Time	V/f CL-V/f OLV CLV AOLV OLV/PM AOLV/PM CLV/PM EZOLV Sets the minimum ON time for virtual digital output 2.	0.1 s (0.0 - 25.0 s)	908
H7-14 (11A8) Expert	Virtual Multi-Function Output 3	V/f CL-V/f OLV CLV AOLV OLV/PM AOLV/PM CLV/PM EZOLV Sets the function for virtual digital output 3.	F (0 - 1A7)	908
H7-15 (11A9) Expert	Virtual Output 3 Delay Time	V/f CL-V/f OLV CLV AOLV OLV/PM AOLV/PM CLV/PM EZOLV Sets the minimum ON time for virtual digital output 3.	0.1 s (0.0 - 25.0 s)	908
H7-16 (11AA) Expert	Virtual Multi-Function Output 4	V/f CL-V/f OLV CLV AOLV OLV/PM AOLV/PM CLV/PM EZOLV Sets the function for virtual digital output 4.	F (0 - 1A7)	909
H7-17 (11AB) Expert	Virtual Output 4 Delay Time	V/f CL-V/f OLV CLV AOLV OLV/PM AOLV/PM CLV/PM EZOLV Sets the minimum ON time for virtual digital output 4.	0.1 s (0.0 - 25.0 s)	909
H7-30 (1177) Expert	Virtual Analog Input Selection	V/f CL-V/f OLV CLV AOLV OLV/PM AOLV/PM CLV/PM EZOLV Sets the virtual analog input function.	F (0 - 32)	909
H7-31 (1178) RUN Expert	Virtual Analog Input Gain	V/f CL-V/f OLV CLV AOLV OLV/PM AOLV/PM CLV/PM EZOLV Sets the virtual analog input gain.	100.0% (-999.9 - 999.9%)	909
H7-32 (1179) RUN Expert	Virtual Analog Input Bias	V/f CL-V/f OLV CLV AOLV OLV/PM AOLV/PM CLV/PM EZOLV Sets the virtual analog input bias.	0.0% (-999.9 - 999.9%)	909
H7-40 (1163)	Virtual Analog Out Signal Select	V/f CL-V/f OLV CLV AOLV OLV/PM AOLV/PM CLV/PM EZOLV Sets the signal level of the virtual analog output. 0 : 0 to 100% (Absolute Value) 1 : -100 to 100% 2 : 0 to 100% (Lower Limit at 0)	0 (0 - 2)	909
H7-41 (1164)	Virtual Analog Output Function	V/f CL-V/f OLV CLV AOLV OLV/PM AOLV/PM CLV/PM EZOLV Sets the monitor to be output from the virtual analog output. Set the x-xx part of the Ux-xx [Monitor]. For example, set H7-41 = 102 to monitor U1-02 [Output Frequency].	102 (0 - 999)	909
H7-42 (1165)	Virtual Analog Output FilterTime	V/f CL-V/f OLV CLV AOLV OLV/PM AOLV/PM CLV/PM EZOLV Sets the time constant for a primary filter of the virtual analog output.	0.00 s (0.00 - 2.00 s)	910

11.11 L: Protection Functions

◆ L1: Motor Protection

No. (Hex.)	Name	Description	Default (Range)	Ref.
L1-01 (0480)	Motor Overload (oL1) Protection	<p>V/f CL-V/f OLV CLV AOLV OLV/PM AOLV/PM CLV/PM EZOLV</p> <p>Sets the motor overload protection with electronic thermal protectors.</p> <p>0 : Disable 1 : Variable Torque 2 : Constant Torque 10:1 Speed Range 3 : Constant Torque 100:1 SpeedRange 4 : PM Variable Torque 5 : PM Constant Torque 6 : Variable Torque (50Hz)</p> <p>Note: When only one motor is connected to a drive, set <i>L1-01</i> = 1 to 6 [Enabled]. External thermal relays are not necessary in these conditions.</p>	Determined by A1-02 (0 - 6)	283
L1-02 (0481)	Motor Overload Protection Time	<p>V/f CL-V/f OLV CLV AOLV OLV/PM AOLV/PM CLV/PM EZOLV</p> <p>Sets the operation time for the electronic thermal protector of the drive to prevent damage to the motor. Usually it is not necessary to change this setting.</p>	1.0 min (0.1 - 5.0 min)	286
L1-03 (0482)	Motor Thermistor oH Alarm Select	<p>V/f CL-V/f OLV CLV AOLV OLV/PM AOLV/PM CLV/PM EZOLV</p> <p>Sets drive operation when the PTC input signal entered into the drive is at the oH3 [Motor Overheat Alarm] detection level.</p> <p>0 : Ramp to Stop 1 : Coast to Stop 2 : Fast Stop (Use C1-09) 3 : Alarm Only</p>	3 (0 - 3)	286
L1-04 (0483)	Motor Thermistor oH Fault Select	<p>V/f CL-V/f OLV CLV AOLV OLV/PM AOLV/PM CLV/PM EZOLV</p> <p>Sets the drive operation when the PTC input signal to the drive is at the oH4 [Motor Overheat Fault (PTC Input)] detection level.</p> <p>0 : Ramp to Stop 1 : Coast to Stop 2 : Fast Stop (Use C1-09)</p>	1 (0 - 2)	287
L1-05 (0484)	Motor Thermistor Filter Time	<p>V/f CL-V/f OLV CLV AOLV OLV/PM AOLV/PM CLV/PM EZOLV</p> <p>Sets the primary delay time constant for the PTC input signal entered to the drive. This parameter prevents accidental motor overheat faults.</p>	0.20 s (0.00 - 10.00 s)	916
L1-08 (1103)	oL1 Current Level	<p>V/f CL-V/f OLV CLV AOLV OLV/PM AOLV/PM CLV/PM EZOLV</p> <p>Sets the reference current for the motor 1 thermal overload detection. When the current level > 0.0 A, you cannot set this value < 10% of drive rated current.</p>	0.0 A (0.0 A or 10% to 150% of the drive rated current)	916
L1-09 (1104)	oL1 Current Level for Motor 2	<p>V/f CL-V/f OLV CLV AOLV OLV/PM AOLV/PM CLV/PM EZOLV</p> <p>Sets the reference current for the motor 2 thermal overload detection. When the current level > 0.0 A, you cannot set this value < 10% of drive rated current.</p>	0.0 A (0.0 A or 10 to 150% of the drive rated current)	916
L1-13 (046D)	Motor Overload Memory Selection	<p>V/f CL-V/f OLV CLV AOLV OLV/PM AOLV/PM CLV/PM EZOLV</p> <p>Sets the function that keeps the current electronic thermal protector value when the drive stops receiving power.</p> <p>0 : Disabled 1 : Enabled</p>	1 (0, 1)	916

◆ L2: Power Loss Ride Through

No. (Hex.)	Name	Description	Default (Range)	Ref.
L2-01 (0485)	Power Loss Ride Through Select	<p>V/f CL-V/f OLV CLV AOLV OLV/PM AOLV/PM CLV/PM EZOLV</p> <p>Sets the drive operation after a momentary power loss.</p> <p>0 : Disable 1 : Enabled 2 : Enabled while CPU Power Active 3 : Kinetic Energy Backup: L2-02 4 : Kinetic Energy Backup: CPU Power 5 : Kinetic Energy Backup: DecelStop</p> <p>Note: When the CPU is inactive, <i>b1-17</i> [Run Command at Power Up] sets operation at power up.</p>	0 (0 - 5)	921
L2-02 (0486)	Power Loss Ride Through Time	<p>V/f CL-V/f OLV CLV AOLV OLV/PM AOLV/PM CLV/PM EZOLV</p> <p>Sets the length of time that the drive will wait before it tries to restart if the DC bus voltage is less than <i>L2-05</i> [Undervoltage Detection Lvl (Uv1)] after a momentary power loss.</p>	Determined by o2-04, C6-01 (0.0 - 25.5 s)	923

11.11 L: Protection Functions

No. (Hex.)	Name	Description	Default (Range)	Ref.
L2-03 (0487)	Minimum Baseblock Time	<p>V/f CL-V/f OLV CLV AOLV OLV/PM AOLV/PM CLV/PM EZOLV</p> <p>Sets the minimum time to continue the drive output block (baseblock) after a baseblock.</p>	Determined by o2-04, C6-01 (0.1 - 5.0 s)	923
L2-04 (0488)	Powerloss V/f Recovery Ramp Time	<p>V/f CL-V/f OLV CLV AOLV OLV/PM AOLV/PM CLV/PM EZOLV</p> <p>Sets the time for the drive output voltage to go back to correct voltage after completing speed searches.</p>	Determined by o2-04, C6-01 (0.0 - 5.0 s)	923
L2-05 (0489)	Undervoltage Detection Lvl (Uv1)	<p>V/f CL-V/f OLV CLV AOLV OLV/PM AOLV/PM CLV/PM EZOLV</p> <p>Sets the voltage at which a <i>Uv1</i> [DC Bus Undervoltage] fault is triggered or at which the KEB function is activated. Usually it is not necessary to change this setting.</p> <p>NOTICE: Damage to Equipment. When you set this parameter to a value lower than the default, you must install an AC reactor on the input side of the power supply. If you do not install an AC reactor, it will cause damage to the drive circuitry.</p>	Determined by o2-04 and E1-01 (200 V Class: 150 - 210 V, 400 V Class: 300 - 420 V)	923
L2-06 (048A) Expert	Kinetic Energy Backup Decel Time	<p>V/f CL-V/f OLV CLV AOLV OLV/PM AOLV/PM CLV/PM EZOLV</p> <p>Sets the deceleration time during KEB operation used to decrease the maximum output frequency to 0.</p> <p>Note: When L2-29 = 1, 2, or 3 [Kinetic Energy Backup Method = Single Drive KEB Ride-Thru 2, System KEB Ride-Thru 1, or System KEB Ride-Thru 2] and you do KEB Auto-Tuning, the drive will automatically set this value.</p>	0.0 s (0.0 - 6000.0 s)	924
L2-07 (048B) Expert	Kinetic Energy Backup Accel Time	<p>V/f CL-V/f OLV CLV AOLV OLV/PM AOLV/PM CLV/PM EZOLV</p> <p>Sets the acceleration time to return the frequency to the frequency reference before a power loss after canceling KEB operation.</p>	0.0 s (0.0 - 6000.0 s)	924
L2-08 (048C) Expert	Frequency Gain at KEB Start	<p>V/f CL-V/f OLV CLV AOLV OLV/PM AOLV/PM CLV/PM EZOLV</p> <p>Sets the quantity of output frequency reduction used when KEB operation starts as a percentage of the motor rated slip before starting KEB operation.</p>	100% (0 - 300%)	924
L2-09 (048D) Expert	KEB Minimum Frequency Level	<p>V/f CL-V/f OLV CLV AOLV OLV/PM AOLV/PM CLV/PM EZOLV</p> <p>Sets the quantity of output frequency reduction used as a percentage of E2-02 [Motor Rated Slip] when KEB operation starts.</p>	20% (0 - 100%)	925
L2-10 (048E) Expert	Minimum KEB Time	<p>V/f CL-V/f OLV CLV AOLV OLV/PM AOLV/PM CLV/PM EZOLV</p> <p>Sets the minimum length of time to operate the KEB after the drive detects a momentary power loss.</p>	50 ms (0 - 25500 ms)	925
L2-11 (0461) Expert	KEB DC Bus Voltage Setpoint	<p>V/f CL-V/f OLV CLV AOLV OLV/PM AOLV/PM CLV/PM EZOLV</p> <p>Sets the target value that controls the DC bus voltage to a constant level in Single Drive KEB Ride-Thru 2. Sets the DC bus voltage level that completes the KEB operation for all other KEB methods.</p>	Determined by E1-01 (Determined by E1-01)	925
L2-29 (0475) Expert	Kinetic Energy Backup Method	<p>V/f CL-V/f OLV CLV AOLV OLV/PM AOLV/PM CLV/PM EZOLV</p> <p>Sets the KEB function operation mode.</p> <p>0 : Single Drive KEB Ride-Thru 1 1 : Single Drive KEB Ride-Thru 2 2 : System KEB Ride-Thru 1 3 : System KEB Ride-Thru 2</p>	0 (0 - 3)	925
L2-30 (045E) Expert	KEB Zero Speed Operation	<p>V/f CL-V/f OLV CLV AOLV OLV/PM AOLV/PM CLV/PM EZOLV</p> <p>Sets the operation when the output frequency decreases below the zero level (DC braking injection starting frequency) during KEB deceleration when L2-01 = 3 to 5 [Power Loss Ride Through Select = Kinetic Energy Backup: L2-02, Kinetic Energy Backup: CPU Power, or Kinetic Energy Backup: DecelStop].</p> <p>0 : Baseblock 1 : DC/SC Braking</p>	0 (0, 1)	926
L2-31 (045D) Expert	KEB Start Voltage Offset Level	<p>V/f CL-V/f OLV CLV AOLV OLV/PM AOLV/PM CLV/PM EZOLV</p> <p>Sets the KEB start voltage offset.</p>	Determined by A1-02 (200 V Class: 0 - 100 V, 400 V Class: 0 - 200 V)	926

◆ L3: Stall Prevention

No. (Hex.)	Name	Description	Default (Range)	Ref.
L3-01 (048F)	Stall Prevention during Accel	<p>V/f CL-V/f OLV CLV AOLV OLV/PM AOLV/PM CLV/PM EZOLV</p> <p>Sets the method of the Stall Prevention During Acceleration.</p> <p>0 : Disabled 1 : Enabled 2 : Intelligent (Ignore Accel Ramp) 3 : Current Limit Acceleration</p>	1 (0 - 3)	927
L3-02 (0490)	Stall Prevent Level during Accel	<p>V/f CL-V/f OLV CLV AOLV OLV/PM AOLV/PM CLV/PM EZOLV</p> <p>Sets the output current level to activate the Stall Prevention function during acceleration as a percentage of the drive rated output current.</p> <p>Note: The upper limit of the setting range changes when C6-01 [Normal / Heavy Duty Selection] changes. • 150% when C6-01 = 0 [Heavy Duty Rating]. • 110% when C6-01 = 1 [Normal Duty Rating].</p>	Determined by C6-01 and L8-38 (0 - 150%)	929
L3-03 (0491)	Stall Prevent Limit during Accel	<p>V/f CL-V/f OLV CLV AOLV OLV/PM AOLV/PM CLV/PM EZOLV</p> <p>Sets the lower limit for the stall prevention level used in the constant output range as a percentage of the drive rated output current.</p>	50% (0 - 100%)	929
L3-04 (0492)	Stall Prevention during Decel	<p>V/f CL-V/f OLV CLV AOLV OLV/PM AOLV/PM CLV/PM EZOLV</p> <p>Sets the method that the drive will use to prevent overvoltage faults when decelerating.</p> <p>Note:</p> <ol style="list-style-type: none"> To connect a dynamic braking option (braking resistor or braking resistor unit) to the drive, set this parameter to 0 or 3. Parameter values 1, 2, 4, and 5 will enable Stall Prevention function during deceleration, and the dynamic braking option will not function. The setting range changes when the A1-02 [Control Method Selection] value changes: <ul style="list-style-type: none"> When A1-02 = 5 [OLV/PM], the setting range is 0 to 2. When A1-02 = 6, 7, 8 [AOLV/PM, CLV/PM, EZOLV], the setting range is 0, 1. <p>0 : Disabled 1 : General Purpose 2 : Intelligent (Ignore Decel Ramp) 3 : General Purpose w/ DB resistor 4 : Overexcitation/High Flux 1 5 : Overexcitation/High Flux 2</p>	1 (Determined by A1-02)	929
L3-05 (0493)	Stall Prevention during RUN	<p>V/f CL-V/f OLV CLV AOLV OLV/PM AOLV/PM CLV/PM EZOLV</p> <p>Sets the function to enable and disable Stall Prevention During Run.</p> <p>Note:</p> <ol style="list-style-type: none"> An output frequency lower than 6 Hz will disable Stall Prevention during Run. The L3-05 and L3-06 [Stall Prevent Level during Run] settings do not have an effect. The setting range changes when the A1-02 [Control Method] value changes: <ul style="list-style-type: none"> A1-02 = 0, 1, 5 [V/f, CL-V/f, OLV/PM]: 0 to 2 A1-02 = 8[EZOLV]: 0, 3 <p>0 : Disabled 1 : Deceleration Time 1 (C1-02) 2 : Deceleration Time 2 (C1-04) 3 : Intelligent (Ignore Decel Ramp)</p>	Determined by A1-02 (0 - Determined by A1-02)	931
L3-06 (0494)	Stall Prevent Level during Run	<p>V/f CL-V/f OLV CLV AOLV OLV/PM AOLV/PM CLV/PM EZOLV</p> <p>Sets the output current level to enable the Stall Prevention function during operation as a percentage of the drive rated output current.</p> <p>Note:</p> <ul style="list-style-type: none"> This parameter is applicable when L3-05 = 1, 2 [Stall Prevention during RUN = Deceleration Time 1 (C1-02), Deceleration Time 2 (C1-04)]. The upper limit of the setting range changes when C6-01 [Normal / Heavy Duty Selection] changes. <ul style="list-style-type: none"> -150% when C6-01 = 0 [Heavy Duty Rating 1 (HD1) for Constant Torque Applications]. -110% when C6-01 = 1 [Normal Duty Rating 1 (ND1) for Variable Torque Applications]. 	Determined by C6-01 and L8-38 (5 - 150%)	931
L3-11 (04C7)	Overvoltage Suppression Select	<p>V/f CL-V/f OLV CLV AOLV OLV/PM AOLV/PM CLV/PM EZOLV</p> <p>Sets the overvoltage suppression function.</p> <p>0 : Disabled 1 : Enabled</p>	0 (0, 1)	932
L3-17 (0462)	DC Bus Regulation Level	<p>V/f CL-V/f OLV CLV AOLV OLV/PM AOLV/PM CLV/PM EZOLV</p> <p>Sets the target value for the DC bus voltage when the overvoltage suppression function and the Decel Stall Prevention function (Intelligent Stall Prevention) are active.</p>	200 V Class: 375 V, 400 V Class: 750 V (200 V Class: 150 to 400 V, 400 V Class: 300 to 800 V)	932
L3-20 (0465) Expert	DC Bus Voltage Adjustment Gain	<p>V/f CL-V/f OLV CLV AOLV OLV/PM AOLV/PM CLV/PM EZOLV</p> <p>Sets the proportional gain used to control the DC bus voltage.</p>	Determined by A1-02 (0.00 - 5.00)	932

11.11 L: Protection Functions

No. (Hex.)	Name	Description	Default (Range)	Ref.
L3-21 (0466) Expert	OVSuppression Accel/Decel P Gain	<input type="checkbox"/> V/f <input type="checkbox"/> CL-V/f <input type="checkbox"/> OLV <input type="checkbox"/> CLV <input type="checkbox"/> AOLV <input type="checkbox"/> OLV/PM <input type="checkbox"/> AOLV/PM <input type="checkbox"/> CLV/PM <input type="checkbox"/> EZOLV Sets the proportional gain to calculate acceleration and deceleration rates.	Determined by A1-02 (0.10 - 10.00)	933
L3-22 (04F9)	PM Stall Prevention Decel Time	<input type="checkbox"/> V/f <input type="checkbox"/> CL-V/f <input type="checkbox"/> OLV <input type="checkbox"/> CLV <input type="checkbox"/> AOLV <input type="checkbox"/> OLV/PM <input type="checkbox"/> AOLV/PM <input type="checkbox"/> CLV/PM <input type="checkbox"/> EZOLV Sets the momentary deceleration time that the drive will use when it tries to accelerate a PM motor and detected motor stalls. This function is applicable when L3-01 = 1 [Stall Prevention during Accel = Enabled].	0.0 s (0.0 - 6000.0 s)	933
L3-23 (04FD)	Stall P Reduction at Constant HP	<input type="checkbox"/> V/f <input type="checkbox"/> CL-V/f <input type="checkbox"/> OLV <input type="checkbox"/> CLV <input type="checkbox"/> AOLV <input type="checkbox"/> OLV/PM <input type="checkbox"/> AOLV/PM <input type="checkbox"/> CLV/PM <input type="checkbox"/> EZOLV Sets the function to automatically decrease the Stall Prevention Level during Run for Constant Horse Power (CHP) part of the speed range. 0 : Use L3-06 for Entire Speed Range 1 : Automatic Reduction @ CHP Region	0 (0, 1)	933
L3-24 (046E) Expert	Motor Accel Time @ Rated Torque	<input type="checkbox"/> V/f <input type="checkbox"/> CL-V/f <input type="checkbox"/> OLV <input type="checkbox"/> CLV <input type="checkbox"/> AOLV <input type="checkbox"/> OLV/PM <input type="checkbox"/> AOLV/PM <input type="checkbox"/> CLV/PM <input type="checkbox"/> EZOLV Sets the motor acceleration time to reach the maximum frequency at the motor rated torque for stopped single-drive motors.	Determined by o2-04, C6-01, E2-11, and E5-01 (0.001 - 10.000 s)	933
L3-25 (046F) Expert	Load Inertia Ratio	<input type="checkbox"/> V/f <input type="checkbox"/> CL-V/f <input type="checkbox"/> OLV <input type="checkbox"/> CLV <input type="checkbox"/> AOLV <input type="checkbox"/> OLV/PM <input type="checkbox"/> AOLV/PM <input type="checkbox"/> CLV/PM <input type="checkbox"/> EZOLV Sets the ratio between motor inertia and machine inertia.	1.0 (0.1 - 1000.0)	934
L3-26 (0455) Expert	Additional DC Bus Capacitors	<input type="checkbox"/> V/f <input type="checkbox"/> CL-V/f <input type="checkbox"/> OLV <input type="checkbox"/> CLV <input type="checkbox"/> AOLV <input type="checkbox"/> OLV/PM <input type="checkbox"/> AOLV/PM <input type="checkbox"/> CLV/PM <input type="checkbox"/> EZOLV Sets the capacity for external main circuit capacitors. Usually it is not necessary to change this setting. Sets this parameter when you use the KEB Ride-Thru function.	0 μF (0 to 65000 μF)	934
L3-27 (0456)	Stall Prevention Detection Time	<input type="checkbox"/> V/f <input type="checkbox"/> CL-V/f <input type="checkbox"/> OLV <input type="checkbox"/> CLV <input type="checkbox"/> AOLV <input type="checkbox"/> OLV/PM <input type="checkbox"/> AOLV/PM <input type="checkbox"/> CLV/PM <input type="checkbox"/> EZOLV Sets a delay time between reaching the Stall Prevention level and starting the Stall Prevention function.	50 ms (0 - 5000 ms)	935
L3-34 (016F) Expert	Torque Limit Delay Time	<input type="checkbox"/> V/f <input type="checkbox"/> CL-V/f <input type="checkbox"/> OLV <input type="checkbox"/> CLV <input type="checkbox"/> AOLV <input type="checkbox"/> OLV/PM <input type="checkbox"/> AOLV/PM <input type="checkbox"/> CLV/PM <input type="checkbox"/> EZOLV Sets the filter time constant that returns the torque limit to its initial value when KEB operation operates in Single Drive KEB Ride-Thru mode.	Determined by A1-02 (0.000 - 1.000 s)	935
L3-35 (0747) Expert	Speed Agree Width for Auto Decel	<input type="checkbox"/> V/f <input type="checkbox"/> CL-V/f <input type="checkbox"/> OLV <input type="checkbox"/> CLV <input type="checkbox"/> AOLV <input type="checkbox"/> OLV/PM <input type="checkbox"/> AOLV/PM <input type="checkbox"/> CLV/PM <input type="checkbox"/> EZOLV Sets the width for speed agreement when L3-04 = 2 [Stall Prevention during Decel = Intelligent (Ignore Decel Ramp)]. Usually it is not necessary to change this setting.	0.00 Hz (0.00 - 1.00 Hz)	935
L3-36 (11D0)	Current Suppression Gain@Accel	<input type="checkbox"/> V/f <input type="checkbox"/> CL-V/f <input type="checkbox"/> OLV <input type="checkbox"/> CLV <input type="checkbox"/> AOLV <input type="checkbox"/> OLV/PM <input type="checkbox"/> AOLV/PM <input type="checkbox"/> CLV/PM <input type="checkbox"/> EZOLV Sets the gain to suppress current and motor speed hunting during operation when L3-01 = 3 [Stall Prevention during Accel = Current Limit Method]. Usually it is not necessary to change this setting.	Determined by A1-02 (0.0 - 100.0)	935
L3-37 (11D1) Expert	Current Limit P Gain @Accel	<input type="checkbox"/> V/f <input type="checkbox"/> CL-V/f <input type="checkbox"/> OLV <input type="checkbox"/> CLV <input type="checkbox"/> AOLV <input type="checkbox"/> OLV/PM <input type="checkbox"/> AOLV/PM <input type="checkbox"/> CLV/PM <input type="checkbox"/> EZOLV Suppresses current hunting during acceleration. Usually it is not necessary to change this setting.	5 ms (0 - 100 ms)	935
L3-38 (11D2) Expert	Current Limit I Time @ Accel	<input type="checkbox"/> V/f <input type="checkbox"/> CL-V/f <input type="checkbox"/> OLV <input type="checkbox"/> CLV <input type="checkbox"/> AOLV <input type="checkbox"/> OLV/PM <input type="checkbox"/> AOLV/PM <input type="checkbox"/> CLV/PM <input type="checkbox"/> EZOLV Suppresses current hunting and overshooting that occurs when the drive stalls during acceleration. Usually it is not necessary to change this setting.	10.0 (0.0 - 100.0)	935
L3-39 (11D3)	Current Limit Filter Time@Accel	<input type="checkbox"/> V/f <input type="checkbox"/> CL-V/f <input type="checkbox"/> OLV <input type="checkbox"/> CLV <input type="checkbox"/> AOLV <input type="checkbox"/> OLV/PM <input type="checkbox"/> AOLV/PM <input type="checkbox"/> CLV/PM <input type="checkbox"/> EZOLV Sets the time constant to adjust the acceleration rate when L3-01 = 3 [Stall Prevention during Accel = Current Limit Acceleration]. Usually it is not necessary to change this setting.	100.0 ms (1.0 - 1000.0 ms)	936
L3-40 (11D4)	Current Limit S-Curve @ Acc/Dec	<input type="checkbox"/> V/f <input type="checkbox"/> CL-V/f <input type="checkbox"/> OLV <input type="checkbox"/> CLV <input type="checkbox"/> AOLV <input type="checkbox"/> OLV/PM <input type="checkbox"/> AOLV/PM <input type="checkbox"/> CLV/PM <input type="checkbox"/> EZOLV Sets the function to enable and disable the best S-curve characteristic used for current-limited acceleration. 0 : Disable 1 : Enabled	0 (0, 1)	936

◆ L4: Speed Detection

No. (Hex.)	Name	Description	Default (Range)	Ref.
L4-01 (0499)	Speed Agree Detection Level	<input type="checkbox"/> V/f <input type="checkbox"/> CL-V/f <input type="checkbox"/> OLV <input type="checkbox"/> CLV <input type="checkbox"/> AOLV <input type="checkbox"/> OLV/PM <input type="checkbox"/> AOLV/PM <input type="checkbox"/> CLV/PM <input type="checkbox"/> EZOLV Sets the level to detect speed agree or motor speed when H2-01 to H2-03 = 2, 3, 4, 5 [MFDO Function Selection = Speed Agree 1, User-set Speed Agree 1, Frequency Detection 1, Frequency Detection 2].	Determined by A1-02 (Determined by A1-02)	936
L4-02 (049A)	Speed Agree Detection Width	<input type="checkbox"/> V/f <input type="checkbox"/> CL-V/f <input type="checkbox"/> OLV <input type="checkbox"/> CLV <input type="checkbox"/> AOLV <input type="checkbox"/> OLV/PM <input type="checkbox"/> AOLV/PM <input type="checkbox"/> CLV/PM <input type="checkbox"/> EZOLV Sets the width to detect speed agree or motor speed. Sets the width to detect speed agree or motor speed when H2-01 to H2-03 = 2, 3, 4, 5 [MFDO Function Selection = Speed Agree 1, User-set Speed Agree 1, Frequency Detection 1, Frequency Detection 2].	Determined by A1-02 (Determined by A1-02)	936

No. (Hex.)	Name	Description	Default (Range)	Ref.
L4-03 (049B)	Speed Agree Detection Level (+/-)	<p>V/f CL-V/f OLV CLV AOLV OLV/PM AOLV/PM CLV/PM EZOLV</p> <p>Sets the level to detect speed agree or motor speed.</p> <p>Sets the speed agree detection level or motor speed detection level when H2-01 to H2-03 = 13, 14, 15, 16 [MFDO Function Selection = Speed Agree 2, User-set Speed Agree 2, Frequency Detection 3, Frequency Detection 4].</p>	Determined by A1-02 (Determined by A1-02)	936
L4-04 (049C)	Speed Agree Detection Width (+/-)	<p>V/f CL-V/f OLV CLV AOLV OLV/PM AOLV/PM CLV/PM EZOLV</p> <p>Sets the width to detect speed agree or motor speed.</p> <p>Sets the width to detect speed agree or motor speed when H2-01 to H2-03 = 13, 14, 15, 16 [MFDO Function Selection = Speed Agree 2, User-set Speed Agree 2, Frequency Detection 3, Frequency Detection 4].</p>	Determined by A1-02 (Determined by A1-02)	936
L4-05 (049D)	Fref Loss Detection Selection	<p>V/f CL-V/f OLV CLV AOLV OLV/PM AOLV/PM CLV/PM EZOLV</p> <p>Sets the operation when the drive detects a loss of frequency reference.</p> <p>0 : Stop 1 : Run at (L4-06 x Last Reference)</p>	0 (0, 1)	937
L4-06 (04C2)	Frequency Reference @Loss of Ref	<p>V/f CL-V/f OLV CLV AOLV OLV/PM AOLV/PM CLV/PM EZOLV</p> <p>Sets the frequency reference as a percentage to continue drive operation after it detects a frequency reference loss. The value is a percentage of the frequency reference before the drive detected the loss.</p>	80.0% (0.0 - 100.0%)	937
L4-07 (0470)	Speed Agree Detection Selection	<p>V/f CL-V/f OLV CLV AOLV OLV/PM AOLV/PM CLV/PM EZOLV</p> <p>Sets the condition that activates speed detection.</p> <p>0 : No Detection during Baseblock 1 : Detection Always Enabled</p>	0 (0, 1)	937

◆ L5: Fault Restart

No. (Hex.)	Name	Description	Default (Range)	Ref.
L5-01 (049E)	Number of Auto-Restart Attempts	<p>V/f CL-V/f OLV CLV AOLV OLV/PM AOLV/PM CLV/PM EZOLV</p> <p>Sets the number of times that the drive will try to restart.</p>	0 (0 - 10 times)	938
L5-02 (049F)	Fault Contact at Restart Select	<p>V/f CL-V/f OLV CLV AOLV OLV/PM AOLV/PM CLV/PM EZOLV</p> <p>Sets the function that sends signals to the MFDO terminal set for Fault [H2-xx = E] while the drive is automatically restarting.</p> <p>0 : Active Only when Not Restarting 1 : Always Active</p>	0 (0, 1)	938
L5-03 (04A0)	Continuous Method Max Restart T	<p>V/f CL-V/f OLV CLV AOLV OLV/PM AOLV/PM CLV/PM EZOLV</p> <p>Sets the time for which the drive will try to restart. If the drive cannot restart in the time set in L5-03, the drive detects a fault. This is available when L5-05 = 0 [Auto-Restart Method = Continuous/Immediate Attempts].</p>	10.0 s (0.5 - 180.0 s)	938
L5-04 (046C)	Interval Method Restart Time	<p>V/f CL-V/f OLV CLV AOLV OLV/PM AOLV/PM CLV/PM EZOLV</p> <p>Sets the time interval between each Auto Restart attempt. This function is enabled when L5-05 = 1 [Auto Restart Operation Selection = Use L5-04 Time].</p>	10.0 s (0.5 - 600.0 s)	938
L5-05 (0467)	Auto-Restart Method	<p>V/f CL-V/f OLV CLV AOLV OLV/PM AOLV/PM CLV/PM EZOLV</p> <p>Sets the count method for the Auto Restart operation.</p> <p>0 : Continuous/Immediate Attempts 1 : Interval/Attempt after L5-04 sec</p>	0 (0, 1)	938

No. (Hex.)	Name	Description	Default (Range)	Ref.
L6-04 (04A4)	Torque Detection Selection 2	<p>V/f CL-V/f OLV CLV AOLV OLV/PM AOLV/PM CLV/PM EZOLV</p> <p>Sets the speed range that detects overtorque and undertorque and the operation of drives (operation status) after detection.</p> <p>0 : Disabled 1 : oL @ Speed Agree - Alarm only 2 : oL @ RUN - Alarm only 3 : oL @ Speed Agree - Fault 4 : oL @ RUN - Fault 5 : UL @ Speed Agree - Alarm only 6 : UL @ RUN - Alarm only 7 : UL @ Speed Agree - Fault 8 : UL @ RUN - Fault</p>	0 (0 - 8)	943
L6-05 (04A5)	Torque Detection Level 2	<p>V/f CL-V/f OLV CLV AOLV OLV/PM AOLV/PM CLV/PM EZOLV</p> <p>Sets the detection level for Overtorque/Undertorque Detection 2. In V/f control, drive rated output current = 100% value. In vector control, motor rated torque = 100% value.</p>	150% (0 - 300%)	944
L6-06 (04A6)	Torque Detection Time 2	<p>V/f CL-V/f OLV CLV AOLV OLV/PM AOLV/PM CLV/PM EZOLV</p> <p>Sets the detection time for Overtorque/Undertorque Detection 2.</p>	0.1 s (0.0 - 10.0 s)	944
L6-07 (04E5)	Torque Detection Filter Time	<p>V/f CL-V/f OLV CLV AOLV OLV/PM AOLV/PM CLV/PM EZOLV</p> <p>Sets the time constant for a primary filter to the torque reference or to the output current used to detect overtorque/undertorque.</p>	0 ms (0 - 1000 ms)	944
L6-08 (0468)	Mechanical Fatigue Detect Select	<p>V/f CL-V/f OLV CLV AOLV OLV/PM AOLV/PM CLV/PM EZOLV</p> <p>Sets the speed where the drive detects mechanical deterioration and how the drive operates (operation status) after detection.</p> <p>0 : Disabled 1 : oL5 @ Speed > L6-09 - Alarm 2 : oL5 @ Speed > L6-09 - Alarm 3 : oL5 @ Speed > L6-09 - Fault 4 : oL5 @ Speed > L6-09 - Fault 5 : UL5 @ Speed < L6-09 - Alarm 6 : UL5 @ Speed < L6-09 - Alarm 7 : UL5 @ Speed < L6-09 - Fault 8 : UL5 @ Speed < L6-09 - Fault</p>	0 (0 - 8)	944
L6-09 (0469)	Mech Fatigue Detect Speed Level	<p>V/f CL-V/f OLV CLV AOLV OLV/PM AOLV/PM CLV/PM EZOLV</p> <p>Sets the speed level where the drive will operate the mechanical deterioration detection function, as a percentage of the Maximum Output Frequency.</p> <p>Note: Parameter A1-02 [Control Method Selection] selects which parameter is the maximum output frequency. • A1-02 ≠ 8 [EZOLV]: E1-04 [Maximum Output Frequency] • A1-02 = 8: E9-02 [Maximum Speed]</p>	110.0% (-110.0 - 110.0%)	945
L6-10 (046A)	Mech Fatigue Detect Delay Time	<p>V/f CL-V/f OLV CLV AOLV OLV/PM AOLV/PM CLV/PM EZOLV</p> <p>Sets the time for mechanical deterioration detection.</p>	0.1 s (0.0 - 10.0 s)	945
L6-11 (046B)	Mech Fatigue Hold Off Time	<p>V/f CL-V/f OLV CLV AOLV OLV/PM AOLV/PM CLV/PM EZOLV</p> <p>Sets the time that the drive will start mechanical deterioration detection triggered by the cumulative operation time of the drive.</p>	0 h (0 - 65535 h)	945

◆ L7: Torque Limit

No. (Hex.)	Name	Description	Default (Range)	Ref.
L7-01 (04A7) RUN	Forward Torque Limit	<p>V/f CL-V/f OLV CLV AOLV OLV/PM AOLV/PM CLV/PM EZOLV</p> <p>Sets the torque limit value for forward motoring as a percentage, where motor rated torque is the 100% value.</p>	200% (0 - 300%)	946
L7-02 (04A8) RUN	Reverse Torque Limit	<p>V/f CL-V/f OLV CLV AOLV OLV/PM AOLV/PM CLV/PM EZOLV</p> <p>Sets the torque limit value for reversed motoring as a percentage, where motor rated torque is the 100% value.</p>	200% (0 - 300%)	946
L7-03 (04A9) RUN	Forward Regenerative Trq Limit	<p>V/f CL-V/f OLV CLV AOLV OLV/PM AOLV/PM CLV/PM EZOLV</p> <p>Sets the torque limit value for forward regenerative conditions as a percentage of the motor rated torque.</p>	200% (0 - 300%)	946
L7-04 (04AA) RUN	Reverse Regenerative Trq Limit	<p>V/f CL-V/f OLV CLV AOLV OLV/PM AOLV/PM CLV/PM EZOLV</p> <p>Sets the torque limit value for reversed regenerative conditions as a percentage of the motor rated torque.</p>	200% (0 - 300%)	947
L7-06 (04AC)	Torque Limit Integral Time	<p>V/f CL-V/f OLV CLV AOLV OLV/PM AOLV/PM CLV/PM EZOLV</p> <p>Sets the integral time constant for the torque limit function.</p>	200 ms (5 - 10000 ms)	947

11.11 L: Protection Functions

No. (Hex.)	Name	Description	Default (Range)	Ref.
L7-07 (04C9)	Torque Limit during Accel/Decel	<p>V/f CL-V/f OLV CLV AOLV OLV/PM AOLV/PM CLV/PM EZOLV</p> <p>Sets the torque limit function during acceleration and deceleration. 0 : Proportional only 1 : Proportional & Integral control</p>	0 (0, 1)	947
L7-16 (044D)	Torque Limit Process at Start	<p>V/f CL-V/f OLV CLV AOLV OLV/PM AOLV/PM CLV/PM EZOLV</p> <p>Assigns a time filter to allow the torque limit to build at start. 0 : Disabled 1 : Enabled</p>	1 (0, 1)	947
L7-35 (1B57) Expert	Low Freq Regen Torque Limit Lvl	<p>V/f CL-V/f OLV CLV AOLV OLV/PM AOLV/PM CLV/PM EZOLV</p> <p>Sets the torque limit used during low-speed regeneration. Usually it is not necessary to change this setting.</p>	50.0% (0.0 - 200.0%)	948
L7-36 (1B58) Expert	Regen Torque Limit Derate Freq	<p>V/f CL-V/f OLV CLV AOLV OLV/PM AOLV/PM CLV/PM EZOLV</p> <p>Sets the frequency width at which L7-35 [Low Freq Regen Torque Limit Lvl] operates.</p>	6.0 Hz (0.0 - 30.0 Hz)	948

◆ L8: Drive Protection

No. (Hex.)	Name	Description	Default (Range)	Ref.
L8-01 (04AD)	3% ERF DB Resistor Protection	<p>V/f CL-V/f OLV CLV AOLV OLV/PM AOLV/PM CLV/PM EZOLV</p> <p>Sets the function to enable braking resistor protection with a Yaskawa ERF series braking resistor (3% ED) installed on the heatsink. 0 : Disabled 1 : Enabled</p>	0 (0, 1)	948
L8-02 (04AE)	Overheat Alarm Level	<p>V/f CL-V/f OLV CLV AOLV OLV/PM AOLV/PM CLV/PM EZOLV</p> <p>Sets the <i>oH</i> detection level in temperature.</p>	Determined by o2-04, C6-01 (50 - 150 °C)	949
L8-03 (04AF)	Overheat Pre-Alarm Selection	<p>V/f CL-V/f OLV CLV AOLV OLV/PM AOLV/PM CLV/PM EZOLV</p> <p>Sets the operation of drives when an <i>oH</i> alarm is detected. 0 : Ramp to Stop 1 : Coast to Stop 2 : Fast Stop (Use C1-09) 3 : Alarm Only 4 : Operate at Reduced Speed (L8-19)</p>	3 (0 - 4)	949
L8-05 (04B1)	Input Phase Loss Protection Sel	<p>V/f CL-V/f OLV CLV AOLV OLV/PM AOLV/PM CLV/PM EZOLV</p> <p>Sets the function to enable and disable input phase loss detection.</p> <p>Note: The default setting and setting range is different for different drive input power supplies.</p> <ul style="list-style-type: none"> • Three-phase 200 V and 400 V Input Default setting: 1 Setting range: Determined by the drive model –2xxx, 4002 - 4675: 0, 1 –4810 - 4H12: 0 - 4 • 6-Phase/12-Pulse 400 V Input Default setting: 4 Setting range: 0 - 4 <p>0 : Disabled 1 : Enabled 4 : Enabled, with Hardware Detection</p>	1 (0 - 4)	950
L8-07 (04B3)	Output Phase Loss Protection Sel	<p>V/f CL-V/f OLV CLV AOLV OLV/PM AOLV/PM CLV/PM EZOLV</p> <p>Sets the function to enable and disable output phase loss detection. The drive starts output phase loss detection when the output current decreases to less than 5% of the drive rated current.</p> <p>Note: The drive can incorrectly start output phase loss detection in these conditions:</p> <ul style="list-style-type: none"> • The motor rated current is very small compared to the drive rating. • The drive is operating a PM motor with a small load. <p>0 : Disabled 1 : Fault when one phase is lost 2 : Fault when two phases are lost</p>	0 (0 - 2)	950
L8-09 (04B5)	Output Ground Fault Detection	<p>V/f CL-V/f OLV CLV AOLV OLV/PM AOLV/PM CLV/PM EZOLV</p> <p>Sets the function to enable and disable ground fault protection. 0 : Disabled 1 : Enabled</p>	Determined by o2-04 (0, 1)	951

No. (Hex.)	Name	Description	Default (Range)	Ref.
L8-10 (04B6)	Heatsink Fan Operation Selection	<p>V/f CL-V/f OLV CLV AOLV OLV/PM AOLV/PM CLV/PM EZOLV</p> <p>Sets operation of the heatsink cooling fan. 0 : During Run, w/ L8-11 Off-Delay 1 : Always On 2 : Temperature-Dependent Fan Ctrl.</p>	0 (0 - 2)	951
L8-11 (04B7)	Heatsink Fan Off-Delay Time	<p>V/f CL-V/f OLV CLV AOLV OLV/PM AOLV/PM CLV/PM EZOLV</p> <p>Sets the length of time that the drive will wait before it stops the cooling fan after it cancels the Run command when <i>L8-10 = 0</i> [<i>Heatsink Fan Operation Selection = During Run, w/ L8-11 Off-Delay</i>].</p>	60 s (0 - 300 s)	951
L8-12 (04B8)	Ambient Temperature Setting	<p>V/f CL-V/f OLV CLV AOLV OLV/PM AOLV/PM CLV/PM EZOLV</p> <p>Sets the ambient temperature of the drive installation area.</p>	40 °C (-10 °C - +50 °C)	474
L8-15 (04BB)	Drive oL2 @ Low Speed Protection	<p>V/f CL-V/f OLV CLV AOLV OLV/PM AOLV/PM CLV/PM EZOLV</p> <p>Sets the function to decrease the drive overload level at which the drive will trigger <i>oL2</i> [<i>Drive Overload</i>] during low speed operation (6 Hz or slower) to prevent damage to the main circuit transistors.</p> <p>Note: Contact Yaskawa or your nearest sales representative before disabling this function at low speeds. If you frequently operate drives with high output current in low speed ranges, it can cause heat stress and decrease the life span of drive IGBTs.</p> <p>0 : Disabled (No Additional Derate) 1 : Enabled (Reduced oL2 Level)</p>	1 (0, 1)	952
L8-18 (04BE)	Software Current Limit Selection	<p>V/f CL-V/f OLV CLV AOLV OLV/PM AOLV/PM CLV/PM EZOLV</p> <p>Set the software current limit selection function to prevent damage to the main circuit transistor caused by too much current.</p> <p>0 : Disabled 1 : Enabled</p>	0 (0, 1)	952
L8-19 (04BF)	Freq Reduction @ oH Pre-Alarm	<p>V/f CL-V/f OLV CLV AOLV OLV/PM AOLV/PM CLV/PM EZOLV</p> <p>Sets the ratio at which the drive derates the frequency reference during an <i>oH</i> alarm.</p>	0.8 (0.1 - 0.9)	952
L8-20 (04C0) Expert	Control Fault & Step Out Detect	<p>V/f CL-V/f OLV CLV AOLV OLV/PM AOLV/PM CLV/PM EZOLV</p> <p>Sets operation after the drive detects a <i>CF</i> fault when <i>A1-02 = 4</i> [<i>Control Method Selection = Advanced Open Loop Vector</i>].</p> <p>0 : Disabled 1 : CF/STPo Detection Enabled 2 : CF ALM/Stop</p>	1 (0 - 2)	952
L8-27 (04DD)	Overcurrent Detection Gain	<p>V/f CL-V/f OLV CLV AOLV OLV/PM AOLV/PM CLV/PM EZOLV</p> <p>Sets the PM motor overcurrent detection level as a percentage of the motor rated current value.</p> <p>Note: Parameter <i>A1-02</i> [<i>Control Method Selection</i>] selects which parameter is the motor rated current. • <i>A1-02 ≠ 8</i> [<i>EZOLV</i>]: <i>E5-03</i> [<i>PM Motor Rated Current (FLA)</i>] • <i>A1-02 = 8</i>: <i>E9-06</i> [<i>Motor Rated Current (FLA)</i>]</p>	300.0% (0.0 - 1000.0%)	953
L8-29 (04DF)	Output Unbalance Detection Sel	<p>V/f CL-V/f OLV CLV AOLV OLV/PM AOLV/PM CLV/PM EZOLV</p> <p>Sets the function to detect <i>LF2</i> [<i>Output Current Imbalance</i>].</p> <p>0 : Disabled 1 : Enabled</p>	1 (0, 1)	953
L8-31 (04E1)	LF2 Detection Time	<p>V/f CL-V/f OLV CLV AOLV OLV/PM AOLV/PM CLV/PM EZOLV</p> <p>Sets the <i>LF2</i> [<i>Output Current Imbalance</i>] detection time.</p>	3 (1 - 100)	953
L8-35 (04EC)	Installation Method Selection	<p>V/f CL-V/f OLV CLV AOLV OLV/PM AOLV/PM CLV/PM EZOLV</p> <p>Sets the type of drive installation.</p> <p>0 : IP00/IP20/UL Open Type/Ex Heatsink 1 : Side-by-Side Mounting 2 : IP20/UL Type 1 3 : Finless</p>	Determined by the drive (0 - 3)	474
L8-38 (04EF)	Carrier Frequency Reduction	<p>V/f CL-V/f OLV CLV AOLV OLV/PM AOLV/PM CLV/PM EZOLV</p> <p>Sets the carrier frequency reduction function. The drive reduces the carrier frequency when the output current is more than a specified level.</p> <p>0 : Disabled 1 : Enabled below 6 Hz 2 : Enabled for All Speeds</p>	Determined by A1-02, C6-01 and o2-04 (0 - 2)	954
L8-40 (04F1)	Carrier Freq Reduction Off-Delay	<p>V/f CL-V/f OLV CLV AOLV OLV/PM AOLV/PM CLV/PM EZOLV</p> <p>Sets the length of time until the automatically reduced carrier frequency returns to the condition before the reduction.</p>	Determined by A1-02 (0.00 - 2.00 s)	954
L8-41 (04F2)	High Current Alarm Selection	<p>V/f CL-V/f OLV CLV AOLV OLV/PM AOLV/PM CLV/PM EZOLV</p> <p>Sets the function to cause an <i>HCA</i> [<i>Current Alarm</i>] when the output current is more than 150% of the drive rated current.</p> <p>0 : Disabled 1 : Enabled</p>	0 (0, 1)	955

11.11 L: Protection Functions

No. (Hex.)	Name	Description	Default (Range)	Ref.
L8-51 (0471) Expert	STPo I Detection Level	<p>V/f CL-V/f OLV CLV AOLV OLV/PM AOLV/PM CLV/PM EZOLV</p> <p>Sets the STPo [Motor Step-Out Detected] detection level as a percentage of the motor rated current.</p> <p>Note: Parameter A1-02 [Control Method Selection] selects which parameter is the motor rated current. • A1-02 = 5 [OLV/PM]: E5-03 [PM Motor Rated Current (FLA)] • A1-02 = 8 [EZOLV]: E9-06 [Motor Rated Current (FLA)]</p>	0.0% (0.0 - 300.0%)	955
L8-52 (0472) Expert	STPo Integration Level	<p>V/f CL-V/f OLV CLV AOLV OLV/PM AOLV/PM CLV/PM EZOLV</p> <p>Sets the detection level for STPo [Motor Step-Out Detected] related to the ACR integral value.</p>	1.0 (0.1 - 2.0)	955
L8-53 (0473) Expert	STPo Integration Time	<p>V/f CL-V/f OLV CLV AOLV OLV/PM AOLV/PM CLV/PM EZOLV</p> <p>Sets the length of time until the drive detects STPo after it is more than the value of L8-51 [STPo I Detection Level].</p>	1.0 s (1.0 - 10.0 s)	955
L8-54 (0474) Expert	STPo Id Diff Detection	<p>V/f CL-V/f OLV CLV AOLV OLV/PM AOLV/PM CLV/PM EZOLV</p> <p>Sets the Id deviation detection function for STPo [Motor Step-Out Detected]. 0 : Disabled 1 : Enabled</p>	1 (0, 1)	955
L8-55 (045F)	Internal DB TransistorProtection	<p>V/f CL-V/f OLV CLV AOLV OLV/PM AOLV/PM CLV/PM EZOLV</p> <p>Sets the protection function for the internal braking transistor. 0 : Disable 1 : Protection Enabled</p>	1 (0, 1)	955
L8-56 (047D) Expert	Stall P @ Accel Activation Time	<p>V/f CL-V/f OLV CLV AOLV OLV/PM AOLV/PM CLV/PM EZOLV</p> <p>Sets the length time that the acceleration stall prevention function can continue to operate before the drive detects an STPo [Motor Step-Out Detected].</p>	5000 ms (100 - 5000 ms)	956
L8-57 (047E) Expert	Stall Prevention Retry Counts	<p>V/f CL-V/f OLV CLV AOLV OLV/PM AOLV/PM CLV/PM EZOLV</p> <p>Sets the number of times the acceleration stall prevention function can operate until speeds agree before the drive detects an STPo [Motor Step-Out Detected].</p>	10 (1 - 10 times)	956
L8-90 (0175) Expert	STPo Detection Level (Low Speed)	<p>V/f CL-V/f OLV CLV AOLV OLV/PM AOLV/PM CLV/PM EZOLV</p> <p>Sets the detection level that the control fault must be equal to or more than to cause an STPo [Motor Step-Out Detected].</p>	Determined by A1-02 (0 - 5000 times)	956
L8-93 (073C) Expert	Low Speed Pull-out DetectionTime	<p>V/f CL-V/f OLV CLV AOLV OLV/PM AOLV/PM CLV/PM EZOLV</p> <p>Sets the length of time the drive will wait to start baseblock after detecting LSo [Low Speed Motor Step-Out].</p>	1.0 s (0.0 - 10.0 s)	956
L8-94 (073D) Expert	Low Speed Pull-out Detect Level	<p>V/f CL-V/f OLV CLV AOLV OLV/PM AOLV/PM CLV/PM EZOLV</p> <p>Sets the detection level for LSo [Low Speed Motor Step-Out] as a percentage of E1-04 [Maximum Output Frequency].</p>	3% (0 - 10%)	956
L8-95 (077F) Expert	Low Speed Pull-out Amount	<p>V/f CL-V/f OLV CLV AOLV OLV/PM AOLV/PM CLV/PM EZOLV</p> <p>Sets the average count of LSo [Low Speed Motor Step-Out] detections.</p>	10 (1 - 50 times)	957

◆ L9: Drive Protection 2

No. (Hex.)	Name	Description	Default (Range)	Ref.
L9-16 (11DC) Expert	FAnI Detect Time	<p>V/f CL-V/f OLV CLV AOLV OLV/PM AOLV/PM CLV/PM EZOLV</p> <p>Sets the detection time for FAnI [Drive Cooling Fan Fault]. Yaskawa recommends that you do not change this parameter value.</p>	4.0 s (0.0 - 30.0 s)	957

11.12 n: Special Adjustment

◆ n1: Hunting Prevention

No. (Hex.)	Name	Description	Default (Range)	Ref.
n1-01 (0580)	Hunting Prevention Selection	V/f CL-V/f OLV CLV AOLV OLV/PM AOLV/PM CLV/PM EZOLV Sets the function to prevent hunting. 0 : Disabled 1 : Enabled (Normal) 2 : Enabled (High Carrier Frequency)	Determined by o2-04 (0 to 2)	958
n1-02 (0581) Expert	Hunting Prevention Gain Setting	V/f CL-V/f OLV CLV AOLV OLV/PM AOLV/PM CLV/PM EZOLV Sets the performance of the hunting prevention function. Usually it is not necessary to change this parameter.	1.00 (0.00 - 2.50)	958
n1-03 (0582) Expert	Hunting Prevention Time Constant	V/f CL-V/f OLV CLV AOLV OLV/PM AOLV/PM CLV/PM EZOLV Sets the primary delay time constant of the hunting prevention function. Usually it is not necessary to change this parameter.	Determined by o2-04 (0 - 500 ms)	958
n1-05 (0530) Expert	Hunting Prevent Gain in Reverse	V/f CL-V/f OLV CLV AOLV OLV/PM AOLV/PM CLV/PM EZOLV Sets the performance of the hunting prevention function. This parameter adjusts Reverse run. Usually it is not necessary to change this parameter.	0.00 (0.00 - 2.50)	958
n1-08 (1105) Expert	Current Detection Method	V/f CL-V/f OLV CLV AOLV OLV/PM AOLV/PM CLV/PM EZOLV Sets how the drive decreases the motor vibration that is caused by leakage current. Usually it is not necessary to change this parameter. 0 : 2-Phases 1 : 3-Phases	0 (0, 1)	959
n1-13 (1B59) Expert	DC Bus Stabilization Control	V/f CL-V/f OLV CLV AOLV OLV/PM AOLV/PM CLV/PM EZOLV Sets the oscillation suppression function for the DC bus voltage. 0 : Disabled 1 : Enabled	0 (0, 1)	959
n1-14 (1B5A) Expert	DC Bus Stabilization Time	V/f CL-V/f OLV CLV AOLV OLV/PM AOLV/PM CLV/PM EZOLV Adjusts the responsiveness of the oscillation suppression function for the DC bus voltage. Set $n1-13 = 1$ [DC Bus Stabilization Control = Enabled] to enable this parameter.	100.0 ms (50.0 - 500.0 ms)	959
n1-15 (0BF8) Expert	PWM Voltage Offset Calibration	V/f CL-V/f OLV CLV AOLV OLV/PM AOLV/PM CLV/PM EZOLV Sets the calibration method that the drive uses to decrease torque/current ripple. 0 : No Calibration 1 : One Time Calibrate at Next Start 2 : Calibrate Every Time at Start	Determined by A1-02 (0 - 2)	959
n1-16 (0BFB)	Hunting Prevention High Fc Gain	V/f CL-V/f OLV CLV AOLV OLV/PM AOLV/PM CLV/PM EZOLV Sets the gain for the hunting prevention function. This parameter functions best with a high carrier frequency. Usually it is not necessary to change this parameter.	Determined by o2-04 (0.00 - 2.50)	960
n1-17 (0BFC) Expert	Hunting Prevent High Fc Filter	V/f CL-V/f OLV CLV AOLV OLV/PM AOLV/PM CLV/PM EZOLV Sets the responsiveness of the hunting prevention function. Usually it is not necessary to change this parameter.	500 ms (0 - 1000 ms)	960
n1-20 (1588) Expert	Voltage Calibration Duration	V/f CL-V/f OLV CLV AOLV OLV/PM AOLV/PM CLV/PM EZOLV Sets the calibration time at start. Usually it is not necessary to change this parameter.	50 ms (10 - 500 ms)	960

◆ n2: Auto Freq Regulator (AFR)

No. (Hex.)	Name	Description	Default (Range)	Ref.
n2-01 (0584)	Automatic Freq Regulator Gain	V/f CL-V/f OLV CLV AOLV OLV/PM AOLV/PM CLV/PM EZOLV Sets the gain of the AFR function as a magnification value. Usually it is not necessary to change this setting.	1.00 (0.00 - 10.00)	960
n2-02 (0585)	Automatic Freq Regulator Time 1	V/f CL-V/f OLV CLV AOLV OLV/PM AOLV/PM CLV/PM EZOLV Sets the time constant that sets the rate of change for the AFR function. Usually it is not necessary to change this setting.	50 ms (0 - 2000 ms)	960
n2-03 (0586)	Automatic Freq Regulator Time 2	V/f CL-V/f OLV CLV AOLV OLV/PM AOLV/PM CLV/PM EZOLV Sets the time constant that sets the speed difference of the AFR function. Use this parameter for speed searches or regeneration. Usually it is not necessary to change this setting.	750 ms (0 - 2000 ms)	961

◆ n3: High Slip/Overexcite Braking

No. (Hex.)	Name	Description	Default (Range)	Ref.
n3-01 (0588) Expert	HSB Deceleration Frequency Width	<input type="checkbox"/> V/f <input type="checkbox"/> CL-V/f <input type="checkbox"/> OLV <input type="checkbox"/> CLV <input type="checkbox"/> AOLV <input type="checkbox"/> OLV/PM <input type="checkbox"/> AOLV/PM <input type="checkbox"/> CLV/PM <input type="checkbox"/> EZOLV Sets the amount by which the output frequency is to be lowered during high-slip braking, as a percentage of E1-04 [Maximum Output Frequency], which represents the 100% value.	5% (1 - 20%)	962
n3-02 (0589) Expert	HSB Current Limit Level	<input type="checkbox"/> V/f <input type="checkbox"/> CL-V/f <input type="checkbox"/> OLV <input type="checkbox"/> CLV <input type="checkbox"/> AOLV <input type="checkbox"/> OLV/PM <input type="checkbox"/> AOLV/PM <input type="checkbox"/> CLV/PM <input type="checkbox"/> EZOLV Sets the maximum current output during high-slip braking as a percentage, where E2-01 [Motor Rated Current (FLA)] is 100%. Also set the current suppression to prevent exceeding drive overload tolerance. Note: The upper limit to the setting range changes when the setting for C6-01 [Normal / Heavy Duty Selection] changes. • 150% when C6-01 = 0 [Heavy Duty Rating] • 110% when C6-01 = 1 [Normal Duty Rating]	Determined by C6-01 and L8-38 (0 - 150%)	963
n3-03 (058A) Expert	HSB Dwell Time at Stop	<input type="checkbox"/> V/f <input type="checkbox"/> CL-V/f <input type="checkbox"/> OLV <input type="checkbox"/> CLV <input type="checkbox"/> AOLV <input type="checkbox"/> OLV/PM <input type="checkbox"/> AOLV/PM <input type="checkbox"/> CLV/PM <input type="checkbox"/> EZOLV Sets the dwell time, a length of time when high-slip braking is ending and during which the motor speed decreases and runs at a stable speed. For a set length of time, the drive will hold the actual output frequency at the minimum output frequency set in E1-09.	1.0 s (0.0 - 10.0 s)	963
n3-04 (058B) Expert	HSB Overload Time	<input type="checkbox"/> V/f <input type="checkbox"/> CL-V/f <input type="checkbox"/> OLV <input type="checkbox"/> CLV <input type="checkbox"/> AOLV <input type="checkbox"/> OLV/PM <input type="checkbox"/> AOLV/PM <input type="checkbox"/> CLV/PM <input type="checkbox"/> EZOLV Sets the time used to detect oL7 [High Slip Braking Overload], which occurs when the output frequency does not change during high-slip braking. Usually it is not necessary to change this parameter.	40 s (30 - 1200 s)	963
n3-13 (0531)	Overexcitation Braking (OEB) Gain	<input type="checkbox"/> V/f <input type="checkbox"/> CL-V/f <input type="checkbox"/> OLV <input type="checkbox"/> CLV <input type="checkbox"/> AOLV <input type="checkbox"/> OLV/PM <input type="checkbox"/> AOLV/PM <input type="checkbox"/> CLV/PM <input type="checkbox"/> EZOLV Sets the gain value that the drive multiplies by the V/f pattern output value during overexcitation deceleration to calculate the overexcitation level.	1.10 (1.00 - 1.40)	963
n3-14 (0532) Expert	OEB High Frequency Injection	<input type="checkbox"/> V/f <input type="checkbox"/> CL-V/f <input type="checkbox"/> OLV <input type="checkbox"/> CLV <input type="checkbox"/> AOLV <input type="checkbox"/> OLV/PM <input type="checkbox"/> AOLV/PM <input type="checkbox"/> CLV/PM <input type="checkbox"/> EZOLV Sets the function that injects harmonic signals during overexcitation deceleration. 0 : Disabled 1 : Enabled	0 (0, 1)	964
n3-21 (0579)	HSB Current Suppression Level	<input type="checkbox"/> V/f <input type="checkbox"/> CL-V/f <input type="checkbox"/> OLV <input type="checkbox"/> CLV <input type="checkbox"/> AOLV <input type="checkbox"/> OLV/PM <input type="checkbox"/> AOLV/PM <input type="checkbox"/> CLV/PM <input type="checkbox"/> EZOLV Sets the upper limit of the current that is suppressed at the time of overexcitation deceleration as a percentage of the drive rated current.	100% (0 - 150%)	964
n3-23 (057B)	Overexcitation Braking Operation	<input type="checkbox"/> V/f <input type="checkbox"/> CL-V/f <input type="checkbox"/> OLV <input type="checkbox"/> CLV <input type="checkbox"/> AOLV <input type="checkbox"/> OLV/PM <input type="checkbox"/> AOLV/PM <input type="checkbox"/> CLV/PM <input type="checkbox"/> EZOLV Sets the direction of motor rotation where the drive will enable overexcitation. 0 : Disabled 1 : Enabled Only when Rotating FWD 2 : Enabled Only when Rotating REV	0 (0 - 2)	964

◆ n4: Adv Open Loop Vector Tune

No. (Hex.)	Name	Description	Default (Range)	Ref.
n4-60 (1B80)	Motoring Low Speed Comp Gain	<input type="checkbox"/> V/f <input type="checkbox"/> CL-V/f <input type="checkbox"/> OLV <input type="checkbox"/> CLV <input checked="" type="checkbox"/> AOLV <input type="checkbox"/> OLV/PM <input type="checkbox"/> AOLV/PM <input type="checkbox"/> CLV/PM <input type="checkbox"/> EZOLV Sets a compensation gain to improve the control qualities for motoring loads in the low speed range.	100.0 % (50.0 - 200.0%)	965
n4-61 (1B81)	Low Speed Comp Frequency Level	<input type="checkbox"/> V/f <input type="checkbox"/> CL-V/f <input type="checkbox"/> OLV <input type="checkbox"/> CLV <input checked="" type="checkbox"/> AOLV <input type="checkbox"/> OLV/PM <input type="checkbox"/> AOLV/PM <input type="checkbox"/> CLV/PM <input type="checkbox"/> EZOLV Sets a frequency at which the settings n4-60 [Motoring Low Speed Comp Gain] and n4-62 [Regen Low Speed Comp Gain] are enabled. When the output frequency < n4-61, the drive adjusts the torque to agree with the settings for n4-60 and n4-62. Usually it is not necessary to change this setting.	6.00 Hz (0.50 - 12.00 Hz)	965
n4-62 (1B82)	Regen Low Speed Comp Gain	<input type="checkbox"/> V/f <input type="checkbox"/> CL-V/f <input type="checkbox"/> OLV <input type="checkbox"/> CLV <input checked="" type="checkbox"/> AOLV <input type="checkbox"/> OLV/PM <input type="checkbox"/> AOLV/PM <input type="checkbox"/> CLV/PM <input type="checkbox"/> EZOLV Sets a compensation gain to improve the control qualities for regenerative loads in the low speed range.	100.0 % (50.0 - 500.0%)	965
n4-63 (1B83)	Speed Estimate Response@ High Freq	<input type="checkbox"/> V/f <input type="checkbox"/> CL-V/f <input type="checkbox"/> OLV <input type="checkbox"/> CLV <input checked="" type="checkbox"/> AOLV <input type="checkbox"/> OLV/PM <input type="checkbox"/> AOLV/PM <input type="checkbox"/> CLV/PM <input type="checkbox"/> EZOLV Sets the responsiveness of the speed estimation in high speed ranges, where the output frequency is ≥ n4-67 [Estimate Gain Switchover Freq].	60.0 (0.1 - 300.0)	965
n4-64 (1B84)	Speed Estimate Response@Low Freq	<input type="checkbox"/> V/f <input type="checkbox"/> CL-V/f <input type="checkbox"/> OLV <input type="checkbox"/> CLV <input checked="" type="checkbox"/> AOLV <input type="checkbox"/> OLV/PM <input type="checkbox"/> AOLV/PM <input type="checkbox"/> CLV/PM <input type="checkbox"/> EZOLV Sets the responsiveness of the speed estimation in low speed ranges, where 0 ≤ the output frequency, which is < n4-67 [Estimate Gain Switchover Freq].	60.0 (0.1 - 300.0)	965
n4-65 (1B85)	Flux Estimate Response@High Freq	<input type="checkbox"/> V/f <input type="checkbox"/> CL-V/f <input type="checkbox"/> OLV <input checked="" type="checkbox"/> CLV <input checked="" type="checkbox"/> AOLV <input type="checkbox"/> OLV/PM <input type="checkbox"/> AOLV/PM <input type="checkbox"/> CLV/PM <input type="checkbox"/> EZOLV Sets the responsiveness of the magnetic flux estimation in high speed ranges, where the output frequency is ≥ n4-67 [Estimate Gain Switchover Freq]. Usually it is not necessary to change this setting.	1.00 (0.50 - 3.00)	966
n4-66 (1B86)	Flux Estimate Response @Low Freq	<input type="checkbox"/> V/f <input type="checkbox"/> CL-V/f <input type="checkbox"/> OLV <input checked="" type="checkbox"/> CLV <input checked="" type="checkbox"/> AOLV <input type="checkbox"/> OLV/PM <input type="checkbox"/> AOLV/PM <input type="checkbox"/> CLV/PM <input type="checkbox"/> EZOLV Sets the responsiveness of the magnetic flux estimation in low speed ranges, where 0 ≤ the output frequency, which is < n4-67 [Estimate Gain Switchover Freq]. Usually it is not necessary to change this setting.	1.50 (0.50 - 3.00)	966

No. (Hex.)	Name	Description	Default (Range)	Ref.
n4-67 (1B87)	Estimate Gain Switchover Freq	V/f CL-V/f OLV CLV AOLV OLV/PM AOLV/PM CLV/PM EZOLV Sets the switching frequency for estimation gain for these parameters: n4-63 [Speed EstimateResponse@High Freq] n4-64 [Speed Estimate Response@Low Freq] n4-65 [Flux Estimate Response@High Freq] n4-66 [Flux Estimate Response @Low Freq] Usually it is not necessary to change this setting.	6.00 Hz (0.00 - E1-04 setting)	966
n4-68 (1B88)	Speed Estimation Filter Time	V/f CL-V/f OLV CLV AOLV OLV/PM AOLV/PM CLV/PM EZOLV Sets the primary delay time constant for the speed estimation value. Usually it is not necessary to change this setting.	0.001 s (0.001 - 0.010 s)	966
n4-69 (1B89)	Flux Control Response	V/f CL-V/f OLV CLV AOLV OLV/PM AOLV/PM CLV/PM EZOLV Unifies control of magnetic flux to make motor vibrations more stable.	1.00 (0.00 - 60.00)	966
n4-70 (1B8A)	Speed Command Comp @ Low Freq	V/f CL-V/f OLV CLV AOLV OLV/PM AOLV/PM CLV/PM EZOLV Sets the function to make the drive more stable when operating at low speeds. Usually it is not necessary to change this setting.	1.00 Hz (0.00 - 6.00 Hz)	966
n4-71 (1B8B) Expert	Flux Estimation Method	V/f CL-V/f OLV CLV AOLV OLV/PM AOLV/PM CLV/PM EZOLV Sets the flux estimation method. Usually it is not necessary to change this setting. 0 : Method 1 1 : Method 2	0 (0, 1)	967
n4-72 (1B8C)	Speed Feedback Mode	V/f CL-V/f OLV CLV AOLV OLV/PM AOLV/PM CLV/PM EZOLV Sets the requirement for an encoder option when A1-02 = 4 [Control Method Selection = Advanced Open Loop Vector]. 0 : Without Encoder 1 : With Encoder	0 (0, 1)	967
n4-73 (1B8D)	PGo Recovery Selection	V/f CL-V/f OLV CLV AOLV OLV/PM AOLV/PM CLV/PM EZOLV Sets the restart mode to Without Encoder Mode or the With Encoder Mode when an encoder is disconnected. 0 : Without Encoder 1 : With Encoder	0 (0, 1)	967
n4-74 (1B8E)	Limit of Flux Loop	V/f CL-V/f OLV CLV AOLV OLV/PM AOLV/PM CLV/PM EZOLV Sets the control level for flux loop control output.	250% (100 - 500%)	967

◆ n5: Feed Forward Control

No. (Hex.)	Name	Description	Default (Range)	Ref.
n5-01 (05B0)	Feed Forward Control Selection	V/f CL-V/f OLV CLV AOLV OLV/PM AOLV/PM CLV/PM EZOLV Sets the feed forward function. 0 : Disabled 1 : Enabled	0 (0, 1)	969
n5-02 (05B1)	Motor Inertia Acceleration Time	V/f CL-V/f OLV CLV AOLV OLV/PM AOLV/PM CLV/PM EZOLV Sets the length of time for the motor to accelerate from the stopped to the maximum frequency with a single motor at the rated torque. Inertia Tuning automatically sets the motor acceleration time.	Determined by C6-01, E5-01, and o2-04 (0.001 - 10.000 s)	969
n5-03 (05B2)	Feed Forward Control Gain	V/f CL-V/f OLV CLV AOLV OLV/PM AOLV/PM CLV/PM EZOLV Sets the ratio between load inertia and motor inertia. Inertia Tuning automatically sets the Feedforward Control Gain value.	1.00 (0.00 - 100.00)	969
n5-04 (05B3) RUN Expert	Speed Response Frequency	V/f CL-V/f OLV CLV AOLV OLV/PM AOLV/PM CLV/PM EZOLV Sets the response frequency for the speed reference. Usually it is not necessary to change this parameter.	Determined by A1-02 (0.00 - 500.00 Hz)	970

◆ n6: Online Tuning

No. (Hex.)	Name	Description	Default (Range)	Ref.
n6-01 (0570)	Online Tuning Selection	<p>V/f CL-V/f OLV CLV AOLV OLV/PM AOLV/PM CLV/PM EZOLV</p> <p>Sets the type of motor data that Online Tuning uses for OLV control. 0 : Disabled 1 : Line-to-Line Resistance Tuning 2 : Voltage Correction Tuning</p>	0 (0 - 2)	970
n6-05 (05C7) Expert	Online Tuning Gain	<p>V/f CL-V/f OLV CLV AOLV OLV/PM AOLV/PM CLV/PM EZOLV</p> <p>Sets the compensation gain when $n6-01 = 2$ [Online Tuning Selection = Voltage Correction Tuning]. Usually it is not necessary to change this parameter.</p>	1.0 (0.1 - 50.0)	971
n6-11 (1B56) Expert	Online Resistance Tuning	<p>V/f CL-V/f OLV CLV AOLV OLV/PM AOLV/PM CLV/PM EZOLV</p> <p>Sets the responsiveness for online resistor tuning. Set this parameter to approximately 1.000 to enable the function. The function is disabled when the value is 0.000.</p>	0.000 (0.000 - 1.000)	971

◆ n7: EZ Drive

No. (Hex.)	Name	Description	Default (Range)	Ref.
n7-01 (3111) Expert	Damping Gain for Low Frequency	<p>V/f CL-V/f OLV CLV AOLV OLV/PM AOLV/PM CLV/PM EZOLV</p> <p>Sets the oscillation suppression gain for the low speed range.</p>	1.0 (0.1 - 10.0)	971
n7-05 (3115) Expert	Response Gain for Load Changes	<p>V/f CL-V/f OLV CLV AOLV OLV/PM AOLV/PM CLV/PM EZOLV</p> <p>Sets the response gain related to changes in the load.</p>	100 (10 - 1000)	971
n7-07 (3117) Expert	Speed Calculation Gain1	<p>V/f CL-V/f OLV CLV AOLV OLV/PM AOLV/PM CLV/PM EZOLV</p> <p>Sets the speed calculation gain during usual operation. Usually it is not necessary to change this setting.</p>	15.0 (1.0 - 50.0)	971
n7-08 (3118) Expert	Speed Calculation Gain2	<p>V/f CL-V/f OLV CLV AOLV OLV/PM AOLV/PM CLV/PM EZOLV</p> <p>Sets the speed calculation gain during a speed search.</p>	25.0 (1.0 - 50.0)	971
n7-10 (311A) Expert	Pull-in Current Switching Speed	<p>V/f CL-V/f OLV CLV AOLV OLV/PM AOLV/PM CLV/PM EZOLV</p> <p>Sets the speed range to operate with the pull-in current command. Drive rated frequency = 100% value. If there is a large quantity of oscillation when you operate in the low speed range, increase the setting value.</p>	10.0% (0.0 - 100.0%)	972
n7-11 (311B) Expert	Drv Mode Switch Hysteresis Band	<p>V/f CL-V/f OLV CLV AOLV OLV/PM AOLV/PM CLV/PM EZOLV</p> <p>Usually it is not necessary to change this setting. Sets the hysteresis level for Switching Speed set in $n7-10$ [Pull-in Current Switching Speed]. When the speed is lower than $n7-10 + n7-11$ during acceleration, the drive enables pull-in current. Note: • When the drive accelerates, it enables these settings: –Motor speed $\leq n7-10 + n7-11: n8-51$ [Pull-in Current @ Acceleration] –Motor speed $> n7-10 + n7-11: b8-01$ [Energy Saving Control Selection] • If there is a large quantity of oscillation when you operate in the low speed range, increase the setting value. • When it is most important to save energy in the low speed range, decrease the setting value.</p>	5.0% (1.0 - 20.0%)	972
n7-13 (311D) Expert	Driving Method Switching Time	<p>V/f CL-V/f OLV CLV AOLV OLV/PM AOLV/PM CLV/PM EZOLV</p> <p>Sets a time to enable the pull-in current commands. If there is a large quantity of oscillation at speeds around $n7-10$ [Pull-in Current Switching Speed], decrease the setting in 20 ms decrements.</p>	100 ms (0 - 1000 ms)	972
n7-17 (3122)	Resistance TemperatureCorrection	<p>V/f CL-V/f OLV CLV AOLV OLV/PM AOLV/PM CLV/PM EZOLV</p> <p>Sets the function to adjust for changes in the motor resistance value caused by changes in the temperature. 0 : Invalid 1 : Valid (Only 1 time) 2 : Valid (Every time)</p>	1 (0 to 2)	972

◆ n8: PM Motor Control Tuning

No. (Hex.)	Name	Description	Default (Range)	Ref.
n8-01 (0540) Expert	Pole Position Detection Current	V/f CL-V/f OLV CLV AOLV OLV/PM AOLV/PM CLV/PM EZOLV Sets the Initial Rotor Position Estimated Current as a percentage where <i>E5-03 [PM Motor Rated Current (FLA)] = 100%</i> . Usually it is not necessary to change this setting.	50% (0 - 100%)	973
n8-02 (0541) Expert	Pole Alignment Current Level	V/f CL-V/f OLV CLV AOLV OLV/PM AOLV/PM CLV/PM EZOLV Sets the current at the time of polar attraction as a percentage where <i>E5-03 [PM Motor Rated Current (FLA)] = 100%</i> . Usually it is not necessary to change this setting.	80% (0 - 150%)	973
n8-03 (0542)	Pole Position Detection Time	V/f CL-V/f OLV CLV AOLV OLV/PM AOLV/PM CLV/PM EZOLV Sets the length of the Current Starting Time, which is used for Z Pulse Offset Tuning. Usually it is not necessary to change this setting.	1.5 s (1.5 - 5.0 s)	973
n8-04 (0543) Expert	Pole Alignment Time	V/f CL-V/f OLV CLV AOLV OLV/PM AOLV/PM CLV/PM EZOLV Sets the length of the Polar Attraction Time, which is used for Z Pulse Offset Tuning. Usually it is not necessary to change this setting.	1.5 s (1.5 - 5.0 s)	973
n8-11 (054A)	Observer Calculation Gain 2	V/f CL-V/f OLV CLV AOLV OLV/PM AOLV/PM CLV/PM EZOLV Sets the gain for speed estimation. Usually it is not necessary to change this setting.	Determined by n8-72 (0.0 - 1000.0)	973
n8-14 (054D) Expert	Polarity Compensation Gain 3	V/f CL-V/f OLV CLV AOLV OLV/PM AOLV/PM CLV/PM EZOLV Sets the gain for speed estimation. Usually it is not necessary to change this setting.	1.000 (0.000 - 10.000)	974
n8-15 (054E) Expert	Polarity Compensation Gain 4	V/f CL-V/f OLV CLV AOLV OLV/PM AOLV/PM CLV/PM EZOLV Sets the gain for speed estimation. Usually it is not necessary to change this setting.	0.500 (0.000 - 10.000)	974
n8-21 (0554) Expert	Motor Back-EMF (K _e) Gain	V/f CL-V/f OLV CLV AOLV OLV/PM AOLV/PM CLV/PM EZOLV Sets the gain for speed estimation. Usually it is not necessary to change this setting.	0.90 (0.80 - 1.00)	974
n8-35 (0562)	Initial Pole Detection Method	V/f CL-V/f OLV CLV AOLV OLV/PM AOLV/PM CLV/PM EZOLV Sets how the drive detects the position of the rotor at start. Note: • When you operate an SPM motor, set <i>n8-35 = 0</i> . When you operate an IPM motor, you can set <i>n8-35 = 0 to 2</i> . • When you set <i>n8-35 = 1</i> , do High Frequency Injection Auto-Tuning. 0 : Pull-in 1 : High Frequency Injection 2 : Pulse Injection	Determined by A1-02 (0 - 2)	974
n8-36 (0563)	HFI Frequency Level for L Tuning	V/f CL-V/f OLV CLV AOLV OLV/PM AOLV/PM CLV/PM EZOLV Sets the injection frequency for high frequency injection. Note: • Set <i>n8-35 = 1 [Initial Pole Detection Method = High Frequency Injection]</i> or <i>n8-57 = 1 [HFI Overlap Selection = Enabled]</i> to enable this parameter. • The drive automatically calculates this value when High Frequency Injection Auto-Tuning completes successfully.	500 Hz (200 - 1000 Hz)	974
n8-37 (0564) Expert	HFI Voltage Amplitude Level	V/f CL-V/f OLV CLV AOLV OLV/PM AOLV/PM CLV/PM EZOLV Sets the high frequency injection amplitude as a percentage where 200 V = 100% for 200 V class drives and 400 V = 100% for a 400 V class drives. Usually it is not necessary to change this setting. Note: • Set <i>n8-35 = 1 [Initial Pole Detection Method = High Frequency Injection]</i> or <i>n8-57 = 1 [HFI Overlap Selection = Enabled]</i> to enable this parameter. • The drive automatically calculates this value when High Frequency Injection Auto-Tuning completes successfully.	20.0% (0.0 - 50.0%)	975
n8-39 (0566)	HFI LPF Cutoff Freq	V/f CL-V/f OLV CLV AOLV OLV/PM AOLV/PM CLV/PM EZOLV Sets the low-pass filter shut-off frequency for high frequency injection. Note: • Set <i>n8-35 = 1 [Initial Pole Detection Method = High Frequency Injection]</i> or <i>n8-57 = 1 [HFI Overlap Selection = Enabled]</i> to enable this parameter. • The drive automatically calculates this value when High Frequency Injection Auto-Tuning completes successfully.	250 Hz (0 - 1000 Hz)	975
n8-41 (0568) Expert	HFI P Gain	V/f CL-V/f OLV CLV AOLV OLV/PM AOLV/PM CLV/PM EZOLV Sets the response gain for the high frequency injection speed estimation. Note: • Set <i>n8-35 = 1 [Initial Pole Detection Method = High Frequency Injection]</i> or <i>n8-57 = 1 [HFI Overlap Selection = Enabled]</i> to enable this parameter. • When <i>A1-02 = 6 [Control Method Selection = AOLV/PM]</i> and you do High Frequency Injection Auto-Tuning, the drive automatically sets this parameter.	2.5 (-10.0 - +10.0)	975
n8-42 (0569) Expert	HFI I Time	V/f CL-V/f OLV CLV AOLV OLV/PM AOLV/PM CLV/PM EZOLV Sets the integral time constant for the high frequency injection speed estimation. Usually it is not necessary to change this setting.	0.10 s (0.00 - 9.99 s)	975

11.12 n: Special Adjustment

No. (Hex.)	Name	Description	Default (Range)	Ref.
n8-45 (0538)	Speed Feedback Detection Gain	<input type="checkbox"/> V/f <input type="checkbox"/> CL-V/f <input type="checkbox"/> OLV <input type="checkbox"/> CLV <input type="checkbox"/> AOLV <input checked="" type="checkbox"/> OLV/PM <input type="checkbox"/> AOLV/PM <input type="checkbox"/> CLV/PM <input type="checkbox"/> EZOLV Sets the internal speed feedback detection reduction unit gain as a magnification value. Usually it is not necessary to change this setting.	0.80 (0.00 - 10.00)	975
n8-47 (053A)	Pull-in Current Comp Filter Time	<input type="checkbox"/> V/f <input type="checkbox"/> CL-V/f <input type="checkbox"/> OLV <input type="checkbox"/> CLV <input type="checkbox"/> AOLV <input checked="" type="checkbox"/> OLV/PM <input type="checkbox"/> AOLV/PM <input type="checkbox"/> CLV/PM <input type="checkbox"/> EZOLV Sets the time constant the drive uses to align the pull-in current reference value with the actual current value. Usually it is not necessary to change this setting.	5.0 s (0.0 - 100.0 s)	976
n8-48 (053B)	Pull-in/Light Load Id Current	<input type="checkbox"/> V/f <input type="checkbox"/> CL-V/f <input type="checkbox"/> OLV <input type="checkbox"/> CLV <input type="checkbox"/> AOLV <input checked="" type="checkbox"/> OLV/PM <input type="checkbox"/> AOLV/PM <input type="checkbox"/> CLV/PM <input type="checkbox"/> EZOLV Sets the d-axis current that flows to the motor during run at constant speed as a percentage where <i>E5-03 [PM Motor Rated Current (FLA)]</i> = 100%.	30% (20 - 200%)	976
n8-49 (053C) Expert	Heavy Load Id Current	<input type="checkbox"/> V/f <input type="checkbox"/> CL-V/f <input type="checkbox"/> OLV <input type="checkbox"/> CLV <input type="checkbox"/> AOLV <input checked="" type="checkbox"/> OLV/PM <input type="checkbox"/> AOLV/PM <input type="checkbox"/> CLV/PM <input type="checkbox"/> EZOLV Sets the d-axis current to that the drive will supply to the motor to run it at a constant speed with a heavy load. Considers <i>E5-03 [PM Motor Rated Current (FLA)]</i> to be 100%. Usually it is not necessary to change this setting.	Determined by E5-01 (-200.0 - 0.0%)	976
n8-51 (053E)	Pull-in Current @ Acceleration	<input type="checkbox"/> V/f <input type="checkbox"/> CL-V/f <input type="checkbox"/> OLV <input type="checkbox"/> CLV <input type="checkbox"/> AOLV <input checked="" type="checkbox"/> OLV/PM <input type="checkbox"/> AOLV/PM <input type="checkbox"/> CLV/PM <input checked="" type="checkbox"/> EZOLV Sets the pull-in current allowed to flow during acceleration/deceleration as a percentage of the motor rated current. Note: Parameter <i>A1-02 [Control Method Selection]</i> selects which parameter is the motor rated current. • <i>A1-02 = 5 [OLV/PM]: E5-03 [PM Motor Rated Current (FLA)]</i> • <i>A1-02 = 8 [EZOLV]: E9-06 [Motor Rated Current (FLA)]</i>	Determined by A1-02 (0 - 200%)	976
n8-54 (056D) Expert	Voltage Error Compensation Time	<input type="checkbox"/> V/f <input type="checkbox"/> CL-V/f <input type="checkbox"/> OLV <input type="checkbox"/> CLV <input type="checkbox"/> AOLV <input checked="" type="checkbox"/> OLV/PM <input type="checkbox"/> AOLV/PM <input type="checkbox"/> CLV/PM <input type="checkbox"/> EZOLV Sets the time constant that the drive uses when adjusting for voltage errors.	1.00 s (0.00 - 10.00 s)	976
n8-55 (056E)	Motor to Load Inertia Ratio	<input type="checkbox"/> V/f <input type="checkbox"/> CL-V/f <input type="checkbox"/> OLV <input type="checkbox"/> CLV <input type="checkbox"/> AOLV <input checked="" type="checkbox"/> OLV/PM <input type="checkbox"/> AOLV/PM <input type="checkbox"/> CLV/PM <input type="checkbox"/> EZOLV Sets the ratio between motor inertia and machine inertia. 0 : Below 1:10 1 : Between 1:10 and 1:30 2 : Between 1:30 and 1:50 3 : Beyond 1:50	0 (0 - 3)	977
n8-57 (0574)	HFI Overlap Selection	<input type="checkbox"/> V/f <input type="checkbox"/> CL-V/f <input type="checkbox"/> OLV <input type="checkbox"/> CLV <input type="checkbox"/> AOLV <input type="checkbox"/> OLV/PM <input checked="" type="checkbox"/> AOLV/PM <input type="checkbox"/> CLV/PM <input type="checkbox"/> EZOLV Sets the function that detects motor speed with high frequency injection. Note: When you set <i>n8-57 = 1</i> , do High Frequency Injection Auto-Tuning. 0 : Disabled 1 : Enabled	0 (0, 1)	977
n8-62 (057D) Expert	Output Voltage Limit Level	<input type="checkbox"/> V/f <input type="checkbox"/> CL-V/f <input type="checkbox"/> OLV <input type="checkbox"/> CLV <input type="checkbox"/> AOLV <input checked="" type="checkbox"/> OLV/PM <input type="checkbox"/> AOLV/PM <input type="checkbox"/> CLV/PM <input checked="" type="checkbox"/> EZOLV Sets the output voltage limit to prevent saturation of the output voltage. Usually it is not necessary to change this parameter. Note: • When <i>A1-02 = 7, 8 [Control Method Selection = CLV/PM EZOLV]</i> , this parameter is available in Expert mode. • 200 V Class: 230.0 V • 400 V Class: 460.0 V	200 V Class: 200.0 V, 400 V Class: 400.0 V (200 V Class: 0.0 to 230.0 V, 400 V Class: 0.0 to 460.0 V)	978
n8-65 (065C) Expert	Speed Fdbk Gain @ oV Suppression	<input type="checkbox"/> V/f <input type="checkbox"/> CL-V/f <input type="checkbox"/> OLV <input type="checkbox"/> CLV <input type="checkbox"/> AOLV <input checked="" type="checkbox"/> OLV/PM <input type="checkbox"/> AOLV/PM <input type="checkbox"/> CLV/PM <input type="checkbox"/> EZOLV Sets the gain of internal speed feedback detection suppression while the overvoltage suppression function is operating as a magnification value. Usually it is not necessary to change this parameter.	1.50 (0.00 - 10.00)	978
n8-69 (065D) Expert	Speed Observer Control P Gain	<input type="checkbox"/> V/f <input type="checkbox"/> CL-V/f <input type="checkbox"/> OLV <input type="checkbox"/> CLV <input type="checkbox"/> AOLV <input type="checkbox"/> OLV/PM <input checked="" type="checkbox"/> AOLV/PM <input type="checkbox"/> CLV/PM <input type="checkbox"/> EZOLV Usually it is not necessary to change this setting. Sets the Proportional gain that the drive uses for speed estimation.	1.00 (0.00 - 20.00)	978
n8-72 (0655) Expert	Speed Estimation Method Select	<input type="checkbox"/> V/f <input type="checkbox"/> CL-V/f <input type="checkbox"/> OLV <input type="checkbox"/> CLV <input type="checkbox"/> AOLV <input type="checkbox"/> OLV/PM <input checked="" type="checkbox"/> AOLV/PM <input type="checkbox"/> CLV/PM <input type="checkbox"/> EZOLV Selects the speed estimation method. Usually it is not necessary to change this setting. 0 : Method 1 1 : Method 2	1 (0, 1)	978
n8-74 (05C3) Expert	Light Load Iq Level	<input type="checkbox"/> V/f <input type="checkbox"/> CL-V/f <input type="checkbox"/> OLV <input type="checkbox"/> CLV <input type="checkbox"/> AOLV <input checked="" type="checkbox"/> OLV/PM <input type="checkbox"/> AOLV/PM <input type="checkbox"/> CLV/PM <input type="checkbox"/> EZOLV Set <i>n8-48 [Pull-in/Light Load Id Current]</i> to the percentage of load current (q-axis current) that you will apply, where <i>E5-03 [PM Motor Rated Current (FLA)]</i> = a setting value of 100%.	30% (0 - 255%)	978
n8-75 (05C4) Expert	Medium Load Iq Level (low)	<input type="checkbox"/> V/f <input type="checkbox"/> CL-V/f <input type="checkbox"/> OLV <input type="checkbox"/> CLV <input type="checkbox"/> AOLV <input checked="" type="checkbox"/> OLV/PM <input type="checkbox"/> AOLV/PM <input type="checkbox"/> CLV/PM <input type="checkbox"/> EZOLV Set <i>n8-78 [Medium Load Id Current]</i> to the percentage of load current (q-axis current) that you will apply, where <i>E5-03 [PM Motor Rated Current (FLA)]</i> = a setting value of 100%.	50% (0 - 255%)	979
n8-77 (05CE) Expert	Heavy Load Iq Level	<input type="checkbox"/> V/f <input type="checkbox"/> CL-V/f <input type="checkbox"/> OLV <input type="checkbox"/> CLV <input type="checkbox"/> AOLV <input checked="" type="checkbox"/> OLV/PM <input type="checkbox"/> AOLV/PM <input type="checkbox"/> CLV/PM <input type="checkbox"/> EZOLV Set <i>n8-49 [Heavy Load Id Current]</i> to the percentage of load current (q-axis current) that you will apply, where <i>E5-03 [PM Motor Rated Current (FLA)]</i> = a setting value of 100%.	90% (0 - 255%)	979
n8-78 (05F4) Expert	Medium Load Id Current	<input type="checkbox"/> V/f <input type="checkbox"/> CL-V/f <input type="checkbox"/> OLV <input type="checkbox"/> CLV <input type="checkbox"/> AOLV <input checked="" type="checkbox"/> OLV/PM <input type="checkbox"/> AOLV/PM <input type="checkbox"/> CLV/PM <input type="checkbox"/> EZOLV Sets the level of the pull-in current for mid-range loads.	0% (0 - 255%)	979

No. (Hex.)	Name	Description	Default (Range)	Ref.
n8-79 (05FE)	Pull-in Current @ Deceleration	<p>V/f CL-V/f OLV CLV AOLV OLV/PM AOLV/PM CLV/PM EZOLV</p> <p>Sets the pull-in current that can flow during deceleration as a percentage of the E5-03 [PM Motor Rated Current (FLA)].</p> <p>Note: When n8-79 = 0, the drive will use the value set in n8-51 [Pull-in Current @ Acceleration].</p>	50% (0 - 200%)	979
n8-84 (02D3) Expert	Polarity Detection Current	<p>V/f CL-V/f OLV CLV AOLV OLV/PM AOLV/PM CLV/PM EZOLV</p> <p>Sets the current that the drive uses to estimate the initial motor magnetic pole as a percentage where E5-03 [PM Motor Rated Current (FLA)] = 100%.</p> <p>Note: The drive automatically calculates this value when High Frequency Injection Auto-Tuning completes successfully.</p>	100% (0 - 150%)	979
n8-94 (012D) Expert	Flux Position Estimation Method	<p>V/f CL-V/f OLV CLV AOLV OLV/PM AOLV/PM CLV/PM EZOLV</p> <p>Sets the criteria that the drive uses to find changes in speed or load. Usually it is not necessary to change this setting.</p> <p>0 : Softstarter 1 : Speed Feedback</p>	Determined by d5-01 (0, 1)	980
n8-95 (012E) Expert	Flux Position Est Filter Time	<p>V/f CL-V/f OLV CLV AOLV OLV/PM AOLV/PM CLV/PM EZOLV</p> <p>Sets the time constant of the filter used for the recognition criteria value for speed and load changes. Usually it is not necessary to change this setting.</p>	30 ms (0 - 100 ms)	980

11.13 o: Keypad-Related Settings

◆ o1: Keypad Display Selection

No. (Hex.)	Name	Description	Default (Range)	Ref.
o1-01 (0500) RUN	User Monitor Selection	V/f CL-V/f OLV CLV AOLV OLV/PM AOLV/PM CLV/PM EZOLV Sets the <i>U</i> monitor for the Drive Mode. This parameter is only available with an LED keypad.	106 (104 - 855)	982
o1-02 (0501) RUN	Monitor Selection at Power-up	V/f CL-V/f OLV CLV AOLV OLV/PM AOLV/PM CLV/PM EZOLV Sets the monitor item that the keypad screen shows after you energize the drive. Refer to "U: Monitors" for information about the monitor items that the keypad screen can show. This parameter is only available with an LED keypad. 1 : Frequency Reference (U1-01) 2 : Direction 3 : Output Frequency (U1-02) 4 : Output Current (U1-03) 5 : User Monitor (<i>o1-01</i>)	1 (1 - 5)	982
o1-03 (0502)	Frequency Display Unit Selection	V/f CL-V/f OLV CLV AOLV OLV/PM AOLV/PM CLV/PM EZOLV Sets the display units for the frequency reference and output frequency. 0 : 0.01 Hz 1 : 0.01% (100% = E1-04) 2 : min ⁻¹ (r/min) units 3 : User Units (o1-10 & o1-11)	Determined by A1-02 (0 - 3)	982
o1-04 (0503)	V/f Pattern Display Unit	V/f CL-V/f OLV CLV AOLV OLV/PM AOLV/PM CLV/PM EZOLV Sets the setting unit for parameters that set the V/f pattern frequency. 0 : Hz 1 : min ⁻¹ (r/min) units	Determined by A1-02 (0, 1)	983
o1-05 (0504) RUN	LCD Contrast Adjustment	V/f CL-V/f OLV CLV AOLV OLV/PM AOLV/PM CLV/PM EZOLV Sets the contrast of the LCD display on the keypad.	5 (0 - 10)	983
o1-10 (0520)	User Units Maximum Value	V/f CL-V/f OLV CLV AOLV OLV/PM AOLV/PM CLV/PM EZOLV Sets the value that the drive shows as the maximum output frequency.	Determined by o1-03 (1 - 60000)	983
o1-11 (0521)	User Units Decimal Position	V/f CL-V/f OLV CLV AOLV OLV/PM AOLV/PM CLV/PM EZOLV Sets the number of decimal places for frequency reference and monitor values. 0 : No Decimal Places (XXXXX) 1 : One Decimal Places (XXXX.X) 2 : Two Decimal Places (XXX.XX) 3 : Three Decimal Places (XX.XXX)	Determined by o1-03 (0 - 3)	984
o1-24 (11AD) RUN	Custom Monitor 1	V/f CL-V/f OLV CLV AOLV OLV/PM AOLV/PM CLV/PM EZOLV You can select a maximum of 12 monitors as user monitors and set them to parameters <i>o1-24</i> to <i>o1-35</i> . This parameter sets the user monitor to show on the first line. The registered monitor is also used for different monitor displays of bar graph, analog meter, and waveform.	101 (0,101 - 9999)	984
o1-25 (11AE) RUN	Custom Monitor 2	V/f CL-V/f OLV CLV AOLV OLV/PM AOLV/PM CLV/PM EZOLV You can select a maximum of 12 monitors as user monitors and set them to parameters <i>o1-24</i> to <i>o1-35</i> . This parameter sets the user monitor to show on the second line. The registered monitor is also used for different monitor displays of bar graph and waveform.	102 (0,101 - 9999)	984
o1-26 (11AF) RUN	Custom Monitor 3	V/f CL-V/f OLV CLV AOLV OLV/PM AOLV/PM CLV/PM EZOLV You can select a maximum of 12 monitors as user monitors and set them to parameters <i>o1-24</i> to <i>o1-35</i> . This parameter sets the user monitor to show on the third line. The registered monitor is also used for the monitor display of the bar graph.	103 (0,101 - 9999)	984
o1-27 (11B0) RUN	Custom Monitor 4	V/f CL-V/f OLV CLV AOLV OLV/PM AOLV/PM CLV/PM EZOLV You can select a maximum of 12 monitors as user monitors and set them to parameters <i>o1-24</i> to <i>o1-35</i> . This parameter sets the user monitor to show on the fourth line.	0 (0,101 - 9999)	984
o1-28 (11B1) RUN	Custom Monitor 5	V/f CL-V/f OLV CLV AOLV OLV/PM AOLV/PM CLV/PM EZOLV You can select a maximum of 12 monitors as user monitors and set them to parameters <i>o1-24</i> to <i>o1-35</i> . This parameter sets the user monitor to show on the fifth line.	0 (0,101 - 9999)	984
o1-29 (11B2) RUN	Custom Monitor 6	V/f CL-V/f OLV CLV AOLV OLV/PM AOLV/PM CLV/PM EZOLV You can select a maximum of 12 monitors as user monitors and set them to parameters <i>o1-24</i> to <i>o1-35</i> . This parameter sets the user monitor to show on the sixth line.	0 (0,101 - 9999)	984
o1-30 (11B3) RUN	Custom Monitor 7	V/f CL-V/f OLV CLV AOLV OLV/PM AOLV/PM CLV/PM EZOLV You can select a maximum of 12 monitors as user monitors and set them to parameters <i>o1-24</i> to <i>o1-35</i> . This parameter sets the user monitor to show on the seventh line.	0 (0,101 - 9999)	984

No. (Hex.)	Name	Description	Default (Range)	Ref.
o1-31 (11B4) RUN	Custom Monitor 8	V/f CL-V/f OLV CLV AOLV OLV/PM AOLV/PM CLV/PM EZOLV You can select a maximum of 12 monitors as user monitors and set them to parameters o1-24 to o1-35. This parameter sets the user monitor to show on the eighth line.	0 (0,101 - 9999)	984
o1-32 (11B5) RUN	Custom Monitor 9	V/f CL-V/f OLV CLV AOLV OLV/PM AOLV/PM CLV/PM EZOLV You can select a maximum of 12 monitors as user monitors and set them to parameters o1-24 to o1-35. This parameter sets the user monitor to show on the ninth line.	0 (0,101 - 9999)	984
o1-33 (11B6) RUN	Custom Monitor 10	V/f CL-V/f OLV CLV AOLV OLV/PM AOLV/PM CLV/PM EZOLV You can select a maximum of 12 monitors as user monitors and set them to parameters o1-24 to o1-35. This parameter sets the user monitor to show on the 10th line.	0 (0,101 - 9999)	984
o1-34 (11B7) RUN	Custom Monitor 11	V/f CL-V/f OLV CLV AOLV OLV/PM AOLV/PM CLV/PM EZOLV You can select a maximum of 12 monitors as user monitors and set them to parameters o1-24 to o1-35. This parameter sets the user monitor to show on the 11th line.	0 (0,101 - 9999)	984
o1-35 (11B8) RUN	Custom Monitor 12	V/f CL-V/f OLV CLV AOLV OLV/PM AOLV/PM CLV/PM EZOLV You can select a maximum of 12 monitors as user monitors and set them to parameters o1-24 to o1-35. This parameter sets the user monitor to show on the 12th line.	0 (0,101 - 9999)	984
o1-36 (11B9) RUN	LCD Backlight Brightness	V/f CL-V/f OLV CLV AOLV OLV/PM AOLV/PM CLV/PM EZOLV Sets the intensity of the LCD keypad backlight.	3 (1 - 5)	984
o1-37 (11BA) RUN	LCD Backlight ON/OFF Selection	V/f CL-V/f OLV CLV AOLV OLV/PM AOLV/PM CLV/PM EZOLV Sets the automatic shut off function for the LCD backlight. 0 : OFF 1 : ON	1 (0, 1)	985
o1-38 (11BB) RUN	LCD Backlight Off-Delay	V/f CL-V/f OLV CLV AOLV OLV/PM AOLV/PM CLV/PM EZOLV Sets the time until the LCD backlight automatically turns off.	60 s (10 - 300 s)	985
o1-39 (11BC) RUN	Show Initial Setup Screen	V/f CL-V/f OLV CLV AOLV OLV/PM AOLV/PM CLV/PM EZOLV Sets the function to show the LCD keypad initial setup screen each time you energize the drive. This parameter is only available with an LCD keypad. 0 : No 1 : Yes	1 (0, 1)	985
o1-40 (11BD) RUN	Home Screen Display Selection	V/f CL-V/f OLV CLV AOLV OLV/PM AOLV/PM CLV/PM EZOLV Sets the monitor display mode for the Home screen. This parameter is only available with an LCD keypad. 0 : Custom Monitor 1 : Bar Graph 2 : Analog Gauge 3 : Trend Plot	0 (0 - 3)	985
o1-41 (11C1) RUN	1st Monitor Area Selection	V/f CL-V/f OLV CLV AOLV OLV/PM AOLV/PM CLV/PM EZOLV Sets the horizontal axis value used to display the monitor set in o1-24 [Custom Monitor 1] as a bar graph. This parameter is only available with an LCD keypad. 0 : +/- Area (- o1-42 ~ o1-42) 1 : + Area (0 ~ o1-42)	0 (0 - 1)	986
o1-42 (11C2) RUN	1st Monitor Area Setting	V/f CL-V/f OLV CLV AOLV OLV/PM AOLV/PM CLV/PM EZOLV Sets the horizontal axis value used to display the monitor set in o1-24 [Custom Monitor 1] as a bar graph. This parameter is only available with an LCD keypad.	100.0% (0.0 - 100.0%)	986
o1-43 (11C3) RUN	2nd Monitor Area Selection	V/f CL-V/f OLV CLV AOLV OLV/PM AOLV/PM CLV/PM EZOLV Selects the horizontal range used to display the monitor set in o1-25 [Custom Monitor 2] as a bar graph. This parameter is only available with an LCD keypad. 0 : +/- Area (- o1-44 ~ o1-44) 1 : + Area (0 ~ o1-44)	0 (0 - 1)	986
o1-44 (11C4) RUN	2nd Monitor Area Setting	V/f CL-V/f OLV CLV AOLV OLV/PM AOLV/PM CLV/PM EZOLV Sets the horizontal axis value used to display the monitor set in o1-25 [Custom Monitor 2] as a bar graph. This parameter is only available with an LCD keypad.	100.0% (0.0 - 100.0%)	986
o1-45 (11C5) RUN	3rd Monitor Area Selection	V/f CL-V/f OLV CLV AOLV OLV/PM AOLV/PM CLV/PM EZOLV Sets the horizontal axis value used to display the monitor set in o1-26 [Custom Monitor 3] as a bar graph. This parameter is only available with an LCD keypad. 0 : +/- Area (- o1-46 ~ o1-46) 1 : + Area (0 ~ o1-46)	0 (0 - 1)	986
o1-46 (11C6) RUN	3rd Monitor Area Setting	V/f CL-V/f OLV CLV AOLV OLV/PM AOLV/PM CLV/PM EZOLV Sets the horizontal axis value used to display the monitor set in o1-26 [Custom Monitor 3] as a bar graph. This parameter is only available with an LCD keypad.	100.0% (0.0 - 100.0%)	986
o1-47 (11C7) RUN	Trend Plot 1 Scale Minimum Value	V/f CL-V/f OLV CLV AOLV OLV/PM AOLV/PM CLV/PM EZOLV Sets the horizontal axis minimum value used to display the monitor set in o1-24 [Custom Monitor 1] as a trend plot. This parameter is only available with an LCD keypad.	-100.0% (-300.0 - +299.9%)	986

11.13 o: Keypad-Related Settings

No. (Hex.)	Name	Description	Default (Range)	Ref.
o1-48 (11C8) RUN	Trend Plot 1 Scale Maximum Value	 Sets the maximum value for the vertical axis used to display the monitor that was set in o1-24 [Custom Monitor 1] as a trend plot. This parameter is only available with an LCD keypad.	100.0% (-299.9 - +300.0%)	987
o1-49 (11C9) RUN	Trend Plot 2 Scale Minimum Value	 Sets the horizontal axis minimum value used to display the monitor set in o1-25 [Custom Monitor 2] as a trend plot. This parameter is only available with an LCD keypad.	-100.0% (-300.0 - +299.9%)	987
o1-50 (11CA) RUN	Trend Plot 2 Scale Maximum Value	 Sets the maximum value for the vertical axis used to display the monitor that was set in o1-25 [Custom Monitor 2] as a trend plot. This parameter is only available with an LCD keypad.	100.0% (-299.9 - +300.0%)	987
o1-51 (11CB) RUN	Trend Plot Time Scale Setting	 Sets the time scale (horizontal axis) to display the trend plot. When you change this setting, the drive automatically adjusts the data sampling time. This parameter is only available with an LCD keypad.	300 s (1 - 3600 s)	987
o1-55 (11EE) RUN	Analog Gauge Area Selection	 Sets the range used to display the monitor set in o1-24 [Custom Monitor 1] as an analog gauge. This parameter is only available with an LCD keypad. 0 : +/- Area (- o1-56 ~ o1-56) 1 : + Area (0 ~ o1-56)	1 (0, 1)	987
o1-56 (11EF) RUN	Analog Gauge Area Setting	 Sets the value used to display the monitor set in o1-24 [Custom Monitor 1] as an analog meter. This parameter is only available with an LCD keypad.	100.0% (0.0 - 100.0%)	987
o1-58 (3125)	Motor Power Unit Selection	 Sets the setting unit for parameters that set the motor rated power. 0 : kW 1 : HP	0 (0, 1)	988

◆ o2: Keypad Operation

No. (Hex.)	Name	Description	Default (Range)	Ref.
o2-01 (0505)	LO/RE Key Function Selection	 Sets the function that lets you use to switch between LOCAL and REMOTE Modes. 0 : Disabled 1 : Enabled	1 (0, 1)	988
o2-02 (0506)	STOP Key Function Selection	 Sets the function to use on the keypad to stop the drive when the Run command source for the drive is REMOTE (external) and not assigned to the keypad. 0 : Disabled 1 : Enabled	1 (0, 1)	989
o2-03 (0507)	User Parameter Default Value	 Sets the function to keep the settings of changed parameters as user parameter defaults to use during initialization. 0 : No change 1 : Set defaults 2 : Clear all	0 (0 - 2)	989
o2-04 (0508)	Drive Model (KVA) Selection	 Sets the Drive Model code. Set this parameter after replacing the control board.	Determined by the drive (-)	989
o2-05 (0509)	Home Mode Freq Ref Entry Mode	 Sets the function that makes it necessary to push to use the keypad to change the frequency reference value while in Drive Mode. 0 : ENTER Key Required 1 : Immediate / MOP-style	0 (0, 1)	990
o2-06 (050A)	Keypad Disconnect Detection	 Sets the function that stops the drive if you disconnect the keypad connection cable from the drive or if you damage the cable while the keypad is the Run command source. 0 : Disabled 1 : Enabled	0 (0, 1)	990
o2-07 (0527)	Keypad RUN Direction @ Power-up	 Sets the direction of motor rotation when the drive is energized and the keypad is the Run command source. 0 : Forward 1 : Reverse	0 (0, 1)	991

No. (Hex.)	Name	Description	Default (Range)	Ref.
o2-09 (050D)	Reserved	-	-	991
o2-23 (11F8) RUN	External 24V Powerloss Detection	V/f CL-V/f OLV CLV AOLV OLV/PM AOLV/PM CLV/PM EZOLV Sets the function to give a warning if the backup external 24 V power supply turns off when the main circuit power supply is in operation. 0 : Disabled 1 : Enabled	0 (0, 1)	991
o2-24 (11FE)	LED Light Function Selection	V/f CL-V/f OLV CLV AOLV OLV/PM AOLV/PM CLV/PM EZOLV Sets the function to show the LED status rings and keypad LED lamps. 0 : Enable Status Ring & Keypad LED 1 : LED Status Ring Disable 2 : Keypad LED Light Disable	0 (0 - 2)	991
o2-26 (1563)	Alarm Display at Ext. 24V Power	V/f CL-V/f OLV CLV AOLV OLV/PM AOLV/PM CLV/PM EZOLV When you connect a backup external 24 V power supply, this parameter sets the function to trigger an alarm when the main circuit power supply voltage decreases. Note: The drive will not run when it is operating from one 24-V external power supply. 0 : Disabled 1 : Enabled	0 (0, 1)	991
o2-27 (1565)	bCE Detection Selection	V/f CL-V/f OLV CLV AOLV OLV/PM AOLV/PM CLV/PM EZOLV Sets drive operation if the Bluetooth device is disconnected when you operate the drive in Bluetooth Mode. 0 : Ramp to Stop 1 : Coast to Stop 2 : Fast Stop (Use <i>CI-09</i>) 3 : Alarm Only 4 : No Alarm Display	3 (0 - 4)	992
o2-33 (1BB6) Expert	Initial Pole Detection (External 24 V Power Supply)	V/f CL-V/f OLV CLV AOLV OLV/PM AOLV/PM CLV/PM EZOLV Sets initial pole detection during the first run after an external 24 V power supply energizes the main circuit. While the main circuit is energized, the drive does not do initial pole detection from the second Run command. Usually it is not necessary to change this setting. 0 : Initial pole detection disabled 1 : Initial pole detection enabled	1 (0, 1)	992

◆ o3: Copy Keypad Function

No. (Hex.)	Name	Description	Default (Range)	Ref.
o3-01 (0515)	Copy Keypad Function Selection	V/f CL-V/f OLV CLV AOLV OLV/PM AOLV/PM CLV/PM EZOLV Sets the function that saves and copies drive parameters to a different drive with the keypad. 0 : Copy Select 1 : Backup (drive → keypad) 2 : Restore (keypad → drive) 3 : Verify (check for mismatch) 4 : Erase (backup data of keypad)	0 (0 - 4)	992
o3-02 (0516)	Copy Allowed Selection	V/f CL-V/f OLV CLV AOLV OLV/PM AOLV/PM CLV/PM EZOLV Sets the copy function when <i>o3-01</i> = 1 [<i>Copy Keypad Function Selection</i> = Backup (drive → keypad)]. 0 : Disabled 1 : Enabled	0 (0, 1)	992
o3-04 (0B3E)	Select Backup/Restore Location	V/f CL-V/f OLV CLV AOLV OLV/PM AOLV/PM CLV/PM EZOLV Sets the storage location for drive parameters when you back up and restore parameters. This parameter is only available when using an LCD keypad. 0 : Memory Location 1 1 : Memory Location 2 2 : Memory Location 3 3 : Memory Location 4	0 (0 - 3)	993
o3-05 (0BDA)	Select Items to Backup/Restore	V/f CL-V/f OLV CLV AOLV OLV/PM AOLV/PM CLV/PM EZOLV Sets which parameters are backed up, restored, and referenced. This parameter is only available when using an LCD keypad. 0 : Standard Parameters 1 : Standard + DWEZ Parameters	0 (0, 1)	993

11.13 o: Keypad-Related Settings

No. (Hex.)	Name	Description	Default (Range)	Ref.
o3-06 (0BDE)	Auto Parameter Backup Selection	<p>V/f CL-V/f OLV CLV AOLV OLV/PM AOLV/PM CLV/PM EZOLV</p> <p>Sets the function that automatically backs up parameters. This parameter is only available when using an LCD keypad.</p> <p>0 : Disabled 1 : Enabled</p>	1 (0, 1)	993
o3-07 (0BDF)	Auto Parameter Backup Interval	<p>V/f CL-V/f OLV CLV AOLV OLV/PM AOLV/PM CLV/PM EZOLV</p> <p>Sets the interval at which the automatic parameter backup function saves parameters from the drive to the keypad.</p> <p>Note: This parameter is only available when using an LCD keypad.</p> <p>0 : Every 10 minutes 1 : Every 30 minutes 2 : Every 60 minutes 3 : Every 12 hours</p>	1 (0 - 3)	993

◆ o4: Maintenance Monitors

No. (Hex.)	Name	Description	Default (Range)	Ref.
o4-01 (050B)	Elapsed Operating Time Setting	<p>V/f CL-V/f OLV CLV AOLV OLV/PM AOLV/PM CLV/PM EZOLV</p> <p>Sets the initial value of the cumulative drive operation time in 10-hour units.</p>	0 h (0 - 9999 h)	994
o4-02 (050C)	Elapsed Operating Time Selection	<p>V/f CL-V/f OLV CLV AOLV OLV/PM AOLV/PM CLV/PM EZOLV</p> <p>Sets the condition that counts the cumulative operation time.</p> <p>0 : U4-01 Shows Total Power-up Time 1 : U4-01 Shows Total RUN Time</p>	0 (0, 1)	994
o4-03 (050E)	Fan Operation Time Setting	<p>V/f CL-V/f OLV CLV AOLV OLV/PM AOLV/PM CLV/PM EZOLV</p> <p>Sets the value from which to start the cumulative drive cooling fan operation time in 10-hour units.</p>	0 h (0 - 9999 h)	994
o4-05 (051D)	Capacitor Maintenance Setting	<p>V/f CL-V/f OLV CLV AOLV OLV/PM AOLV/PM CLV/PM EZOLV</p> <p>Sets the U4-05 [CapacitorMaintenance] monitor value.</p>	0% (0 - 150%)	994
o4-07 (0523)	Softcharge Relay Maintenance Set	<p>V/f CL-V/f OLV CLV AOLV OLV/PM AOLV/PM CLV/PM EZOLV</p> <p>Sets the U4-06 [PreChargeRelayMainte] monitor value.</p>	0% (0 - 150%)	995
o4-09 (0525)	IGBT Maintenance Setting	<p>V/f CL-V/f OLV CLV AOLV OLV/PM AOLV/PM CLV/PM EZOLV</p> <p>Sets the U4-07 [IGBT Maintenance] monitor value.</p>	0% (0 - 150%)	995
o4-11 (0510)	Fault Trace/History Init (U2/U3)	<p>V/f CL-V/f OLV CLV AOLV OLV/PM AOLV/PM CLV/PM EZOLV</p> <p>Resets the records of Monitors U2-xx [Fault Trace] and U3-xx [Fault History].</p> <p>0 : Disabled 1 : Enabled</p>	0 (0, 1)	995
o4-12 (0512)	kWh Monitor Initialization	<p>V/f CL-V/f OLV CLV AOLV OLV/PM AOLV/PM CLV/PM EZOLV</p> <p>Resets the monitor values for U4-10 [kWh, Lower 4 Digits] and U4-11 [kWh, Upper 5 Digits].</p> <p>0 : No Reset 1 : Reset</p>	0 (0, 1)	995
o4-13 (0528)	RUN Command Counter @ Initialize	<p>V/f CL-V/f OLV CLV AOLV OLV/PM AOLV/PM CLV/PM EZOLV</p> <p>Resets the monitor values for U4-02 [Num of Run Commands], U4-24 [Number of Runs (Low)], and U4-25 [Number of Runs (High)].</p> <p>0 : No Reset 1 : Reset</p>	0 (0, 1)	995
o4-22 (154F) RUN	Time Format	<p>V/f CL-V/f OLV CLV AOLV OLV/PM AOLV/PM CLV/PM EZOLV</p> <p>Sets the time display format. This parameter is only available when using an LCD keypad.</p> <p>0 : 24 Hour Clock 1 : 12 Hour Clock 2 : 12 Hour JP Clock</p>	0 (0 - 2)	996
o4-23 (1550) RUN	Date Format	<p>V/f CL-V/f OLV CLV AOLV OLV/PM AOLV/PM CLV/PM EZOLV</p> <p>Sets the date display format. This parameter is only available when using an LCD keypad.</p> <p>0 : YYYY/MM/DD 1 : DD/MM/YYYY 2 : MM/DD/YYYY</p>	0 (0 - 2)	996
o4-24 (310F) RUN	bAT Detection Selection	<p>V/f CL-V/f OLV CLV AOLV OLV/PM AOLV/PM CLV/PM EZOLV</p> <p>Sets operation when the drive detects bAT [Keypad Battery Low Voltage] and TiM [Keypad Time Not Set].</p> <p>0 : Disable 1 : Enable (Alarm Detected) 2 : Enable (Fault Detected)</p>	0 (0 - 2)	996

◆ o5: Log Function

No. (Hex.)	Name	Description	Default (Range)	Ref.
o5-00 (1E81) RUN	Log Type	<p>V/f CL-V/f OLV CLV AOLV OLV/PM AOLV/PM CLV/PM EZOLV</p> <p>Sets the type of data log function. This parameter is only available when you use an LCD keypad.</p> <p>0 : Long Term Log 1 : Short Term Log</p>	0 (0, 1)	1000
o5-01 (1551) RUN	Log Start/Stop Selection	<p>V/f CL-V/f OLV CLV AOLV OLV/PM AOLV/PM CLV/PM EZOLV</p> <p>Sets the data log function. This parameter is only available when using an LCD keypad.</p> <p>0 : OFF 1 : ON</p>	0 (0 - 1)	1000
o5-02 (1552) RUN	Log Sampling Interval	<p>V/f CL-V/f OLV CLV AOLV OLV/PM AOLV/PM CLV/PM EZOLV</p> <p>Sets the data log sampling cycle. This parameter is only available when you use an LCD keypad.</p> <p>Note: The default setting and setting range change when o5-00 [Normal / Heavy Duty Selection] changes.</p> <ul style="list-style-type: none"> • o5-00 = 0 [Long Term Log] <ul style="list-style-type: none"> –Default setting: 1000 ms –Setting range: 100 - 60000 ms • o5-00 = 1 [Short Term Log] <ul style="list-style-type: none"> –Default setting: 10 ms –Setting range: 1 - 99 ms 	Determined by o5-00 (Determined by o5-00)	1000
o5-03 (1553) RUN	Log Monitor Data 1	<p>V/f CL-V/f OLV CLV AOLV OLV/PM AOLV/PM CLV/PM EZOLV</p> <p>Sets the data log monitor. This parameter is only available with an LCD keypad.</p>	101 (000, 101 - 999)	1000
o5-04 (1554) RUN	Log Monitor Data 2	<p>V/f CL-V/f OLV CLV AOLV OLV/PM AOLV/PM CLV/PM EZOLV</p> <p>Sets the data log monitor (Ux-xx). This parameter is only available when you use an LCD keypad.</p> <p>Note: Set the x-xx part of the Ux-xx [Monitor]. For example, set o5-04 = 102 to monitor U1-02 [Output Frequency]. When the x part of Ux is a letter, replace the letter (hexadecimal number) with a decimal number. For example, set o5-04 = 1301 to monitor Ud-01.</p>	102 (000, 101 - 999)	1001
o5-05 (1555) RUN	Log Monitor Data 3	<p>V/f CL-V/f OLV CLV AOLV OLV/PM AOLV/PM CLV/PM EZOLV</p> <p>Sets the data log monitor. This parameter is only available with an LCD keypad.</p>	103 (000, 101 - 999)	1001
o5-06 (1556) RUN	Log Monitor Data 4	<p>V/f CL-V/f OLV CLV AOLV OLV/PM AOLV/PM CLV/PM EZOLV</p> <p>Sets the data log monitor. This parameter is only available with an LCD keypad.</p>	107 (000, 101 - 999)	1001
o5-07 (1557) RUN	Log Monitor Data 5	<p>V/f CL-V/f OLV CLV AOLV OLV/PM AOLV/PM CLV/PM EZOLV</p> <p>Sets the data log monitor. This parameter is only available with an LCD keypad.</p>	108 (000, 101 - 999)	1001
o5-08 (1558) RUN	Log Monitor Data 6	<p>V/f CL-V/f OLV CLV AOLV OLV/PM AOLV/PM CLV/PM EZOLV</p> <p>Sets the data log monitor (Ux-xx). This parameter is only available when you use an LCD keypad.</p> <p>Note: Set the x-xx part of the Ux-xx [Monitor]. For example, set o5-08 = 101 to monitor U1-01 [Frequency Reference]. When the x part of Ux is a letter, replace the letter (hexadecimal number) with a decimal number. For example, set o5-08 = 1301 to monitor Ud-01.</p>	000 (000, 101 - 999)	1001
o5-09 (1559) RUN	Log Monitor Data 7	<p>V/f CL-V/f OLV CLV AOLV OLV/PM AOLV/PM CLV/PM EZOLV</p> <p>Sets the data log monitor (Ux-xx). This parameter is only available when you use an LCD keypad.</p> <p>Note: Set the x-xx part of the Ux-xx [Monitor]. For example, set o5-09 = 101 to monitor U1-01 [Frequency Reference]. When the x part of Ux is a letter, replace the letter (hexadecimal number) with a decimal number. For example, set o5-09 = 1301 to monitor Ud-01.</p>	000 (000, 101 - 999)	1002
o5-10 (155A) RUN	Log Monitor Data 8	<p>V/f CL-V/f OLV CLV AOLV OLV/PM AOLV/PM CLV/PM EZOLV</p> <p>Sets the data log monitor. This parameter is only available with an LCD keypad.</p>	000 (000, 101 - 999)	1002
o5-11 (155B) RUN	Log Monitor Data 9	<p>V/f CL-V/f OLV CLV AOLV OLV/PM AOLV/PM CLV/PM EZOLV</p> <p>Sets the data log monitor. This parameter is only available with an LCD keypad.</p>	000 (000, 101 - 999)	1002
o5-12 (155C) RUN	Log Monitor Data 10	<p>V/f CL-V/f OLV CLV AOLV OLV/PM AOLV/PM CLV/PM EZOLV</p> <p>Sets the data log monitor. This parameter is only available with an LCD keypad.</p>	000 (000, 101 - 999)	1002

11.13 o: Keypad-Related Settings

No. (Hex.)	Name	Description	Default (Range)	Ref.
o5-15 (1E82) RUN	Trigger Type Selection	<p>V/f CL-V/f OLV CLV AOLV OLV/PM AOLV/PM CLV/PM EZOLV</p> <p>Sets the type of trigger for the short-term data log. This parameter is only available when you use an LCD keypad.</p> <p>0 : Digital Trigger 1 : Analog Trigger</p>	0 (0, 1)	1002
o5-16 (1E83) RUN	Digital Trigger Object	<p>V/f CL-V/f OLV CLV AOLV OLV/PM AOLV/PM CLV/PM EZOLV</p> <p>Sets the function for the digital trigger target from the setting values for multi-function digital outputs. This parameter is only available when you use an LCD keypad.</p>	E (0 - FF)	1003
o5-17 (1E84) RUN	Analog Trigger Object	<p>V/f CL-V/f OLV CLV AOLV OLV/PM AOLV/PM CLV/PM EZOLV</p> <p>Sets the monitor for the analog trigger target. This parameter is only available when you use an LCD keypad.</p> <p>Note:</p> <ul style="list-style-type: none"> Set the <i>x-xx</i> part of the <i>Ux-xx</i> [Monitor]. For example, set <i>o5-17 = 101</i> to monitor <i>U1-01</i> [Frequency Reference]. When the <i>x</i> part of <i>Ux</i> is a letter, replace the letter (hexadecimal number) with a decimal number. For example, set <i>o5-17 = 1301</i> to monitor <i>Ud-01</i>. When it is not necessary to set a data log monitor, set this parameter to <i>000</i>. 	102 (0 - 9999)	1003
o5-18 (1E85) RUN	Analog Trigger Level	<p>V/f CL-V/f OLV CLV AOLV OLV/PM AOLV/PM CLV/PM EZOLV</p> <p>Sets the level to compare with the analog trigger target. This parameter is only available when you use an LCD keypad.</p>	0.0% (-999.9% - +999.9%)	1003
o5-19 (1E86) RUN	Trigger Condition	<p>V/f CL-V/f OLV CLV AOLV OLV/PM AOLV/PM CLV/PM EZOLV</p> <p>Sets the condition with which to detect the trigger. This parameter is only available when you use an LCD keypad.</p> <p>0 : Rising Edge 1 : Falling Edge</p>	0 (0, 1)	1003
o5-20 (1E87) RUN	Pre-Trigger Setting	<p>V/f CL-V/f OLV CLV AOLV OLV/PM AOLV/PM CLV/PM EZOLV</p> <p>Sets the percentage of data to save before the drive detects the trigger for the short-term data log. This parameter is only available when you use an LCD keypad.</p>	90% (0% - 100%)	1003
o5-21 (1E88) RUN	Trend Log Sampling Time Selection	<p>V/f CL-V/f OLV CLV AOLV OLV/PM AOLV/PM CLV/PM EZOLV</p> <p>Sets the sampling cycle for the trend log to save data before the drive detects the trigger. The trend log works at the same time as the short-term data log. This parameter is only available when you use an LCD keypad.</p> <p>0 : Trend Log Disabled 1 : 0.1 s (About 1 hour) 2 : 1 s (About 10 hours) 3 : 10 s (About 100 hours) 4 : 60 s (About 600 hours)</p>	0 (0 - 4)	1004

11.14 q: DriveWorksEZ Parameters

◆ q1-01 to qx-xx: Reserved for DriveWorksEZ

No. (Hex.)	Name	Description	Default (Range)
q1-01 to qx-xx (1600 - xxxx)	Reserved for DriveWorksEZ	V/f CL-V/f OLV CLV AOLV OLV/PM AOLV/PM CLV/PM EZOLV These parameters are reserved for use with DriveWorksEZ.	Refer to "DriveWorksEZ Operation Manual".

11.15 r: DWEZ Connection 1-20

◆ r1-01 to r1-40: DriveWorksEZ Connection Parameters 1 to 20 (Upper / Lower)

No. (Hex.)	Name	Description	Default (Range)
r1-01 to r1-40: (1840 - 1867)	DriveWorksEZ Connection Parameters 1 to 20 (Upper / Lower)	V/f CL-V/f OLV CLV AOLV OLV/PM AOLV/PM CLV/PM EZOLV DriveWorksEZ Connection Parameters 1 to 20 (Upper / Lower)	0 (0 - FFFFH)

11.16 T: Motor Tuning

◆ T0: Tuning Mode Selection

No. (Hex.)	Name	Description	Default (Range)	Ref.
T0-00 (1197)	Tuning Mode Selection	<p>V/f CL-V/f OLV CLV AOLV OLV/PM AOLV/PM CLV/PM EZOLV</p> <p>Sets the type of Auto-Tuning. 0 : Motor Parameter Tuning 1 : Control Tuning</p>	0 (0, 1)	1005

◆ T1: InductionMotor Auto-Tuning

No. (Hex.)	Name	Description	Default (Range)	Ref.
T1-00 (0700)	Motor 1/Motor 2 Selection	<p>V/f CL-V/f OLV CLV AOLV OLV/PM AOLV/PM CLV/PM EZOLV</p> <p>Sets which motor to tune when motor 1/2 switching is enabled. You can only use the keypad to set this parameter. You cannot use external input terminals to set it.</p> <p>Note: This parameter is enabled when $HI-xx = 16$ [Motor 2 Selection] is set. When $HI-xx \neq 16$ the keypad will not show this parameter. 1 : Motor 1 (sets E1-xx, E2-xx) 2 : Motor 2 (sets E3-xx, E4-xx)</p>	1 (1, 2)	1005
T1-01 (0701)	Auto-Tuning Mode Selection	<p>V/f CL-V/f OLV CLV AOLV OLV/PM AOLV/PM CLV/PM EZOLV</p> <p>Sets the type of Auto-Tuning. 0 : Rotational Auto-Tuning 1 : Stationary Auto-Tuning 1 2 : Stationary Line-Line Resistance</p>	Determined by A1-02 (Determined by A1-02)	1006
T1-02 (0702)	Motor Rated Power	<p>V/f CL-V/f OLV CLV AOLV OLV/PM AOLV/PM CLV/PM EZOLV</p> <p>Sets the motor rated output in the units from 01-58 [Motor Power Unit Selection].</p> <p>Note: On drive models 2xxx, and 4002 to 4675, the setting unit is 0.01 kW. The setting range is 0.00 kW to 650.00 kW (0.00 HP to 650.00 HP). On drive models 4810 to 4H12, the setting unit is 0.1 kW. The setting range is 0.0 kW to 1000.0 kW (0.0 HP to 1340.5 HP).</p>	Determined by o2-04, C6-01 (0.00 - 1000.0)	1006
T1-03 (0703)	Motor Rated Voltage	<p>V/f CL-V/f OLV CLV AOLV OLV/PM AOLV/PM CLV/PM EZOLV</p> <p>Sets the rated voltage (V) of the motor. Enter the base speed voltage for constant output motors.</p>	Determined by o2-04, C6-01 (200 V Class: 0.0 - 255.5 V, 400 V Class: 0.0 - 511.0 V)	1006
T1-04 (0704)	Motor Rated Current	<p>V/f CL-V/f OLV CLV AOLV OLV/PM AOLV/PM CLV/PM EZOLV</p> <p>Sets the rated current (A) of the motor.</p>	Determined by o2-04 (10% to 200% of the drive rated current)	1006
T1-05 (0705)	Motor Base Frequency	<p>V/f CL-V/f OLV CLV AOLV OLV/PM AOLV/PM CLV/PM EZOLV</p> <p>Sets the base frequency (Hz) of the motor.</p>	50.0 Hz (0.0 - 590.0 Hz)	1006
T1-06 (0706)	Number of Motor Poles	<p>V/f CL-V/f OLV CLV AOLV OLV/PM AOLV/PM CLV/PM EZOLV</p> <p>Sets the number of motor poles.</p>	4 (2 to 120)	1007
T1-07 (0707)	Motor Base Speed	<p>V/f CL-V/f OLV CLV AOLV OLV/PM AOLV/PM CLV/PM EZOLV</p> <p>Sets the motor base speed for Auto-Tuning (min^{-1} (r/min)).</p>	1450 min^{-1} (r/min) (0 - 35400 min^{-1} (r/min))	1007
T1-08 (0708)	Encoder Pulse Count (PPR)	<p>V/f CL-V/f OLV CLV AOLV OLV/PM AOLV/PM CLV/PM EZOLV</p> <p>Sets the number of PG (pulse generator, encoder) pulses.</p>	1024 ppr (0 - 60,000 ppr)	1007
T1-09 (0709)	Motor No-Load Current	<p>V/f CL-V/f OLV CLV AOLV OLV/PM AOLV/PM CLV/PM EZOLV</p> <p>Sets the no-load current of the motor.</p>	- (0 A - T1-04; max. of 2999.9)	1007
T1-10 (070A)	Motor Rated Slip Frequency	<p>V/f CL-V/f OLV CLV AOLV OLV/PM AOLV/PM CLV/PM EZOLV</p> <p>Sets motor rated slip.</p>	- (0.000 - 20.000 Hz)	1007
T1-11 (070B)	Motor Iron Loss	<p>V/f CL-V/f OLV CLV AOLV OLV/PM AOLV/PM CLV/PM EZOLV</p> <p>Sets the iron loss to calculate the energy-saving coefficient.</p>	Determined by E2-10 or E4-10 (0 - 65535 W)	1007

11.16 T: Motor Tuning

No. (Hex.)	Name	Description	Default (Range)	Ref.
T1-12 (0BDB)	Test Mode Selection	<p>V/f CL-V/f OLV CLV AOLV OLV/PM AOLV/PM CLV/PM EZOLV</p> <p>Sets the function to enable Test Mode after Stationary Auto-Tuning. When you can operate the motor with a light load attached after Stationary Auto-Tuning is complete, enable this parameter.</p> <p>Note: You must first set $T1-10 = 0$ [Motor Rated Slip Frequency = 0 Hz] to enable this parameter. 0 : No 1 : Yes</p>	0 (0, 1)	1008
T1-13 (0BDC)	No-load voltage	<p>V/f CL-V/f OLV CLV AOLV OLV/PM AOLV/PM CLV/PM EZOLV</p> <p>Sets the no-load voltage of the motor. When the no-load voltage at rated speed is available, for example on the motor test report, set the voltage in this parameter. If the no-load voltage is not available, do not change this parameter.</p> <p>Note: To get the same qualities as a Yaskawa 1000-series drive or previous series drive, set this parameter = $T1-03$ [Motor Rated Voltage].</p>	$T1-03 \times 0.85$ (200 V Class: 0.0 - 255.0 V, 400 V Class: 0.0 - 510.0 V)	1008

◆ T2: PM Motor Auto-Tuning

No. (Hex.)	Name	Description	Default (Range)	Ref.
T2-01 (0750)	PM Auto-Tuning Selection	<p>V/f CL-V/f OLV CLV AOLV OLV/PM AOLV/PM CLV/PM EZOLV</p> <p>Sets the type of Auto-Tuning for PM motors. 0 : Manual Entry w/ Motor Data Sheet 1 : Stationary (Ld, Lq, R) 2 : Stationary (R Only) 3 : Z-Pulse Offset (Pole Position) 4 : Rotational (Ld, Lq, R, back-EMF) 5 : High Frequency Injection</p>	0 (Determined by A1-02)	1008
T2-02 (0751)	PM Motor Code Selection	<p>V/f CL-V/f OLV CLV AOLV OLV/PM AOLV/PM CLV/PM EZOLV</p> <p>Enter the PM motor code as specified by the rotation speed and motor output.</p>	Determined by A1-02 and o2-04 (0000 - FFFF)	1009
T2-03 (0752)	PM Motor Type	<p>V/f CL-V/f OLV CLV AOLV OLV/PM AOLV/PM CLV/PM EZOLV</p> <p>Sets the type of PM motor the drive will operate. 0 : IPM motor 1 : SPM motor</p>	1 (0, 1)	1009
T2-04 (0730)	PM Motor Rated Power	<p>V/f CL-V/f OLV CLV AOLV OLV/PM AOLV/PM CLV/PM EZOLV</p> <p>Sets the PM motor rated output in the units from o1-58 [Motor Power Unit Selection].</p> <p>Note: On drive models 2xxx, and 4002 to 4675, the setting unit is 0.01 kW. The setting range is 0.00 kW to 650.00 kW (0.00 HP to 650.00 HP). On drive models 4810 to 4H12, the setting unit is 0.1 kW. The setting range is 0.0 kW to 1000.0 kW (0.0 HP to 1340.5 HP).</p>	Determined by o2-04, C6-01 (0.00 - 1000.0)	1009
T2-05 (0732)	PM Motor Rated Voltage	<p>V/f CL-V/f OLV CLV AOLV OLV/PM AOLV/PM CLV/PM EZOLV</p> <p>Sets the rated voltage (V) of the motor.</p>	200 V Class: 200.0 V, 400 V Class: 400.0 V (200 V Class: 0.0 - 255.0 V, 400 V Class: 0.0 - 510.0 V)	1009
T2-06 (0733)	PM Motor Rated Current	<p>V/f CL-V/f OLV CLV AOLV OLV/PM AOLV/PM CLV/PM EZOLV</p> <p>Sets the rated current (A) of the motor.</p>	Determined by o2-04 (10% to 200% of the drive rated current)	1009
T2-07 (0753)	PM Motor Base Frequency	<p>V/f CL-V/f OLV CLV AOLV OLV/PM AOLV/PM CLV/PM EZOLV</p> <p>Sets the base frequency (Hz) of the motor.</p>	87.5 Hz (0.0 - 590.0 Hz)	1009
T2-08 (0734)	Number of PM Motor Poles	<p>V/f CL-V/f OLV CLV AOLV OLV/PM AOLV/PM CLV/PM EZOLV</p> <p>Sets the number of motor poles.</p>	6 (2 - 120)	1010
T2-09 (0731)	PM Motor Base Speed	<p>V/f CL-V/f OLV CLV AOLV OLV/PM AOLV/PM CLV/PM EZOLV</p> <p>Sets the motor base speed (min⁻¹ (r/min)).</p>	1750 min ⁻¹ (r/min) (0 - 34500 min ⁻¹ (r/min))	1010
T2-10 (0754)	PM Motor Stator Resistance	<p>V/f CL-V/f OLV CLV AOLV OLV/PM AOLV/PM CLV/PM EZOLV</p> <p>Sets the stator resistance for each motor phase.</p> <p>Note: • This parameter does not set line-to-line resistance. • On drive models 4810 to 4H12, the unit is mΩ, and the setting range is 0.000 mΩ to 65.000 mΩ.</p>	Determined by T2-02 (0.000 - 65.000 Ω)	1010
T2-11 (0735)	PM Motor d-Axis Inductance	<p>V/f CL-V/f OLV CLV AOLV OLV/PM AOLV/PM CLV/PM EZOLV</p> <p>Sets the d-axis inductance of the motor on a per phase basis.</p>	Determined by T2-02 (0.00 - 600.00 mH)	1010
T2-12 (0736)	PM Motor q-Axis Inductance	<p>V/f CL-V/f OLV CLV AOLV OLV/PM AOLV/PM CLV/PM EZOLV</p> <p>Sets the q-axis inductance of the motor on a per phase basis.</p>	Determined by T2-02 (0.00 - 600.00 mH)	1010

No. (Hex.)	Name	Description	Default (Range)	Ref.
T2-13 (0755)	Back-EMF Units Selection	V/f CL-V/f OLV CLV AOLV OLV/PM AOLV/PM CLV/PM EZOLV Sets the units that the drive uses to set the induced voltage constant. 0 : mV/(rev/min) 1 : mV/(rad/sec)	1 (0, 1)	1010
T2-14 (0737)	Back-EMF Voltage Constant (Ke)	V/f CL-V/f OLV CLV AOLV OLV/PM AOLV/PM CLV/PM EZOLV Sets the motor induced voltage constant (Ke).	Determined by T2-13 (0.0 - 2000.0)	1010
T2-15 (0756)	Pull-In Current Level	V/f CL-V/f OLV CLV AOLV OLV/PM AOLV/PM CLV/PM EZOLV Sets the level of the pull-in current as a percentage of E5-03 [PM Motor Rated Current (FLA)]. Usually it is not necessary to change this setting.	30% (0 - 120%)	1010
T2-16 (0738)	Encoder Pulse Count (PPR)	V/f CL-V/f OLV CLV AOLV OLV/PM AOLV/PM CLV/PM EZOLV Sets the number of PG (pulse generator, encoder) pulses.	1024 ppr (1 - 15000 ppr)	1011
T2-17 (0757)	Encoder Z-Pulse Offset	V/f CL-V/f OLV CLV AOLV OLV/PM AOLV/PM CLV/PM EZOLV Sets the encoder Z-pulse offset ($\Delta\theta$) (pulse generator, encoder) that is listed on the motor nameplate.	0.0° (-180.0 - +180.0°)	1011

◆ T3: ASR and Inertia Tuning

No. (Hex.)	Name	Description	Default (Range)	Ref.
T3-00 (1198)	Control Loop Tuning Selection	V/f CL-V/f OLV CLV AOLV OLV/PM AOLV/PM CLV/PM EZOLV Sets the type of Control Auto-Tuning. 0 : Inertia Tuning 1 : ASR (Speed Regulator) 2 : Deceleration Rate Tuning 3 : KEB Tuning Note: Settings 0 and 1 are available only when A1-02 = 3, 7 [Control Method Selection = CLV, CLV/PM].	0 (0 - 3)	1011
T3-01 (0760)	Test Signal Frequency	V/f CL-V/f OLV CLV AOLV OLV/PM AOLV/PM CLV/PM EZOLV Sets the frequency of the test signal applied to the motor during Inertia Tuning. Usually it is not necessary to change this setting.	3.0 Hz (0.1 - 20.0 Hz)	1011
T3-02 (0761)	Test Signal Amplitude	V/f CL-V/f OLV CLV AOLV OLV/PM AOLV/PM CLV/PM EZOLV Sets the amplitude of the test signal applied to the motor during Inertia Tuning. Usually it is not necessary to change this setting.	0.5 rad (0.1 - 10.0 rad)	1011
T3-03 (0762)	Motor Inertia	V/f CL-V/f OLV CLV AOLV OLV/PM AOLV/PM CLV/PM EZOLV Sets the inertia of the motor. This value uses the test signal response to calculate the load inertia. Note: The display units for the default setting and setting range are different for different models: • 0.0001 kgm ² units (setting range: 0.0001 kgm ² to 6.0000 kgm ²): 2004 to 2021, 4002 to 4012 • 0.001 kgm ² units (setting range: 0.001 kgm ² to 60.000 kgm ²): 2030 to 2211, 4018 to 4103 • 0.01 kgm ² units (setting range: 0.01 kgm ² to 600.00 kgm ²): 2257 to 2415, 4140 to 4H12	Determined by o2-04, C6-01, and E5-01 (0.0001 - 600.00 kgm ²)	1011
T3-04 (0763)	System Response Frequency	V/f CL-V/f OLV CLV AOLV OLV/PM AOLV/PM CLV/PM EZOLV This parameter uses the load inertia value from the Inertia Tuning process to automatically calculate and set C5-01 [ASR Proportional Gain 1].	10.0 Hz (0.1 - 50.0 Hz)	1012

◆ T4: EZ Tuning

No. (Hex.)	Name	Description	Default (Range)	Ref.
T4-01 (3130)	EZ Tuning Mode Selection	V/f CL-V/f OLV CLV AOLV OLV/PM AOLV/PM CLV/PM EZOLV Sets the type of Auto-Tuning for EZOLV control. 0 : Motor Parameter Setting 1 : Line-to-Line Resistance	0 (0, 1)	1012
T4-02 (3131)	Motor Type Selection	V/f CL-V/f OLV CLV AOLV OLV/PM AOLV/PM CLV/PM EZOLV Sets the type of motor. 0 : Induction (IM) 1 : Permanent Magnet (PM) 2 : Synchronous Reluctance (SynRM)	0 (0, 1, 2)	1012
T4-04 (3133)	Motor Rated Revolutions	V/f CL-V/f OLV CLV AOLV OLV/PM AOLV/PM CLV/PM EZOLV Sets rated rotation speed (min ⁻¹) of the motor.	- ((40 Hz to 120 Hz) × 60 × 2/E9-08)	1012

11.16 T: Motor Tuning

No. (Hex.)	Name	Description	Default (Range)	Ref.
T4-05 (3134)	Motor Rated Frequency	<p>V/f CL-V/f OLV CLV AOLV OLV/PM AOLV/PM CLV/PM EZOLV</p> <p>Sets the rated frequency (Hz) of the motor.</p>	Determined by E9-01 and o2-04 (40.0 - 120.0 Hz)	1013
T4-06 (3135)	Motor Rated Voltage	<p>V/f CL-V/f OLV CLV AOLV OLV/PM AOLV/PM CLV/PM EZOLV</p> <p>Sets the rated voltage (V) of the motor.</p>	200 V Class: 200.0 V, 400 V Class: 400.0 V (200 V Class: 0.0 - 255.0 V, 400 V Class: 0.0 - 510.0 V)	1013
T4-07 (3136)	Motor Rated Current	<p>V/f CL-V/f OLV CLV AOLV OLV/PM AOLV/PM CLV/PM EZOLV</p> <p>Sets the rated current (A) of the motor.</p>	Determined by o2-04, C6-01 (10% to 200% of the drive rated current)	1013
T4-08 (3137)	PM Motor Rated Power	<p>V/f CL-V/f OLV CLV AOLV OLV/PM AOLV/PM CLV/PM EZOLV</p> <p>Sets the motor rated output in the units from o1-58 [Motor Power Unit Selection].</p> <p>Note: On drive models 2xxx, and 4002 to 4675, the setting unit is 0.01 kW. The setting range is 0.10 kW to 650.00 kW (0.10 HP to 650.00 HP). On drive models 4810 to 4H12, the setting unit is 0.1 kW. The setting range is 0.1 kW to 1000.0 kW (0.1 HP to 1340.5 HP).</p>	Determined by E9-10 (0.10 - 1000.0)	1013
T4-09 (3138)	Number of Poles	<p>V/f CL-V/f OLV CLV AOLV OLV/PM AOLV/PM CLV/PM EZOLV</p> <p>Sets the number of motor poles.</p>	Determined by E9-01 (2 - 120)	1013

11.17 U: Monitors

◆ U1: Operation Status Monitors

No. (Hex.)	Name	Description	MFAO Signal Level
U1-01 (0040)	Frequency Reference	<p>V/f CL-V/f OLV CLV AOLV OLV/PM AOLV/PM CLV/PM EZOLV</p> <p>Shows the frequency reference value. Parameter <i>o1-03</i> [Keypad Display Unit Selection] sets the display units. Unit: 0.01 Hz</p>	10 V = Maximum frequency (0 V to +10 V)
U1-02 (0041)	Output frequency	<p>V/f CL-V/f OLV CLV AOLV OLV/PM AOLV/PM CLV/PM EZOLV</p> <p>Shows the output frequency. Parameter <i>o1-03</i> [Keypad Display Unit Selection] sets the display units. Unit: 0.01 Hz</p>	10 V = Maximum frequency (0 V to +10 V)
U1-03 (0042)	Output current	<p>V/f CL-V/f OLV CLV AOLV OLV/PM AOLV/PM CLV/PM EZOLV</p> <p>Shows the output current. The keypad shows the value of <i>U1-03</i> in amperes (A). When you use MEMOBUS/Modbus communications to show the monitor, the current is "8192 = drive rated current (A)". Use the formula: "Numerals being displayed / 8192 × drive rated current (A)" to use the MEMOBUS/Modbus communication current value shown in the monitor. Unit: When the drive model changes, the display units for this parameter also change.</p> <ul style="list-style-type: none"> • 0.01 A: 2004 - 2042, 4002 - 4023 • 0.1 A: 2056 - 2415, 4031 - 4675 • 1 A: 4810 - 4H12 	10 V = Drive rated current
U1-04 (0043)	Control Method	<p>V/f CL-V/f OLV CLV AOLV OLV/PM AOLV/PM CLV/PM EZOLV</p> <p>Shows the drive control method.</p> <p>0 : V/f Control 1 : V/f Control with Encoder 2 : Open Loop Vector 3 : Closed Loop Vector 4 : Advanced Open Loop Vector 5 : PM Open Loop Vector 6 : PM Advanced Open Loop Vector 7 : PM Closed Loop Vector 8 : EZ Vector Control</p>	No signal output available
U1-05 (0044)	Motor Speed	<p>V/f CL-V/f OLV CLV AOLV OLV/PM AOLV/PM CLV/PM EZOLV</p> <p>Shows the detected motor speed. Parameter <i>o1-03</i> [Keypad Display Unit Selection] sets the display units. Unit: 0.01 Hz</p>	10 V = Maximum frequency (0 V to +10 V)
U1-06 (0045)	Output Voltage Ref	<p>V/f CL-V/f OLV CLV AOLV OLV/PM AOLV/PM CLV/PM EZOLV</p> <p>Shows the output voltage reference. Unit: 0.1 V</p>	200 V Class: 10 V = 200 Vrms 400 V Class: 10 V = 400 Vrms
U1-07 (0046)	DC Bus Voltage	<p>V/f CL-V/f OLV CLV AOLV OLV/PM AOLV/PM CLV/PM EZOLV</p> <p>Shows the DC bus voltage. Unit: 1 V</p>	200 V Class: 10 V = 400 V 400 V Class: 10 V = 800 V
U1-08 (0047)	Output Power	<p>V/f CL-V/f OLV CLV AOLV OLV/PM AOLV/PM CLV/PM EZOLV</p> <p>Shows the internally-calculated output power. When you change <i>A1-02</i> [Control Method Selection], it will also change the signal level of the analog output.</p> <ul style="list-style-type: none"> • <i>A1-02</i> = 0, 1: Drive capacity (kW) • <i>A1-02</i> = 2, 3, 4: PM Motor Rated Power [E2-11] (kW) • <i>A1-02</i> = 5, 6, 7: PM Motor Rated Power [E5-02] (kW) • <i>A1-02</i> = 8: Motor Rated Power [E9-07] (kW) <p>Unit: The display units are different for different models:</p> <ul style="list-style-type: none"> • 0.01 kW: 2004 - 2042, 4002 - 4023 • 0.1 kW: 2056 - 2415, 4031 - 4H12 	10 V: Drive capacity (motor rated power) kW (-10 V to +10 V)
U1-09 (0048)	Torque Reference	<p>V/f CL-V/f OLV CLV AOLV OLV/PM AOLV/PM CLV/PM EZOLV</p> <p>Shows the internal torque reference value. Unit: 0.1%</p>	10 V = Motor rated torque (0 V to +10 V)

No. (Hex.)	Name	Description	MFAO Signal Level
U1-10 (0049)	Input Terminal Status	<p>V/f CL-V/f OLV CLV AOLV OLV/PM AOLV/PM CLV/PM EZOLV</p> <p>Shows the status of the MFDI terminal where 1 = ON, 0 = OFF. For example, <i>U1-10</i> shows "0000011" when terminals S1 and S2 are ON. bit0 : Terminal S1 (MFDI 1) bit1 : Terminal S2 (MFDI 2) bit2 : Terminal S3 (MFDI 3) bit3 : Terminal S4 (MFDI 4) bit4 : Terminal S5 (MFDI 5) bit5 : Terminal S6 (MFDI 6) bit6 : Terminal S7 (MFDI 7) bit7 : Terminal S8 (MFDI 8)</p>	No signal output available
U1-11 (004A)	Output Terminal Status	<p>V/f CL-V/f OLV CLV AOLV OLV/PM AOLV/PM CLV/PM EZOLV</p> <p>Shows the status of the MFDO terminal where 1 = ON and 0 = OFF. For example, <i>U1-11</i> shows "0000011" when terminals M1 and M3 are ON. Note: When <i>H2-xx = 100 to 1A7</i> [Inverse Output of Function], <i>U1-11</i> does not show the status in inverse. bit0 : Terminal M1-M2 bit1 : Terminal M3-M4 bit2 : Terminal M5-M6 bit3 : Not used (normal value of 0). bit4 : Not used (normal value of 0). bit5 : Not used (normal value of 0). bit6 : Not used (normal value of 0). bit7 : Fault relay MA/MB-MC</p>	No signal output available
U1-12 (004B)	Drive Status	<p>V/f CL-V/f OLV CLV AOLV OLV/PM AOLV/PM CLV/PM EZOLV</p> <p>Shows drive status where 1 = ON and 0 = OFF. For example, <i>U1-12</i> shows "0000101" during run with the Reverse Run command. bit0 : During Run bit1 : During zero-speed bit2 : During reverse bit3 : During fault reset signal input bit4 : During speed agreement bit5 : Drive ready bit6 : During minor fault detection bit7 : During fault detection</p>	No signal output available
U1-13 (004E)	Terminal A1 Level	<p>V/f CL-V/f OLV CLV AOLV OLV/PM AOLV/PM CLV/PM EZOLV</p> <p>Shows the signal level of terminal A1. Unit: 0.1%</p>	10 V = 100% (0 V to +10 V)
U1-14 (004F)	Terminal A2 Level	<p>V/f CL-V/f OLV CLV AOLV OLV/PM AOLV/PM CLV/PM EZOLV</p> <p>Shows the signal level of terminal A2. Unit: 0.1%</p>	10 V = 100% (0 V to +10 V)
U1-15 (0050)	Terminal A3 Level	<p>V/f CL-V/f OLV CLV AOLV OLV/PM AOLV/PM CLV/PM EZOLV</p> <p>Shows the signal level of terminal A3. Unit: 0.1%</p>	10 V = 100% (-10 V to +10 V)
U1-16 (0053)	SFS Output Frequency	<p>V/f CL-V/f OLV CLV AOLV OLV/PM AOLV/PM CLV/PM EZOLV</p> <p>Shows the output frequency after soft start. Shows the frequency with acceleration and deceleration times and S-curves. Parameter <i>o1-03</i> [Keypad Display Unit Selection] sets the display units. Unit: 0.01 Hz</p>	10 V = Maximum frequency (0 V to +10 V)
U1-17 (0058)	DI-A3 Input Status	<p>V/f CL-V/f OLV CLV AOLV OLV/PM AOLV/PM CLV/PM EZOLV</p> <p>Shows the reference value input from DI-A3 option. Shows the input signal for DI-A3 in hexadecimal as set in <i>F3-01</i> [Digital Input Function Selection]. 3FFFF: Set (1 bit) + Sign (1 bit) + 16 bit</p>	No signal output available
U1-18 (0061)	oPE Fault Parameter	<p>V/f CL-V/f OLV CLV AOLV OLV/PM AOLV/PM CLV/PM EZOLV</p> <p>Shows the parameter number that caused the <i>oPE02</i> [Parameter Range Setting Error] or <i>oPE08</i> [Parameter Selection Error].</p>	No signal output available

No. (Hex.)	Name	Description	MFAO Signal Level
U1-19 (0066)	MEMOBUS/Modbus Error Code	<p>V/f CL-V/f OLV CLV AOLV OLV/PM AOLV/PM CLV/PM EZOLV</p> <p>Shows the contents of the MEMOBUS/Modbus communication error where 1 = "error" and 0 = "no error". For example, U1-19 shows "0000001" when there is a CRC error.</p> <p>bit0 : CRC Error bit1 : Data Length Error bit2 : Not used (normal value of 0). bit3 : Parity Error bit4 : Overrun Error bit5 : Framing Error bit6 : Timed Out bit7 : Not used (normal value of 0).</p>	No signal output available
U1-21 (0077)	AI-A3 Term V1 Level	<p>V/f CL-V/f OLV CLV AOLV OLV/PM AOLV/PM CLV/PM EZOLV</p> <p>Shows the analog reference of terminal V1 on analog input option card AI-A3. Unit: 0.1%</p>	10 V = 100% (-10 V to +10 V)
U1-22 (072A)	AI-A3 Term V2 Level	<p>V/f CL-V/f OLV CLV AOLV OLV/PM AOLV/PM CLV/PM EZOLV</p> <p>Shows the analog reference of terminal V2 on analog input option card AI-A3. Unit: 0.1%</p>	10 V = 100% (-10 V to +10 V)
U1-23 (072B)	AI-A3 Term V3 Level	<p>V/f CL-V/f OLV CLV AOLV OLV/PM AOLV/PM CLV/PM EZOLV</p> <p>Shows the analog reference of terminal V3 on analog input option card AI-A3. Unit: 0.1%</p>	10 V = 100% (-10 V to +10 V)
U1-24 (007D)	Input Pulse Monitor	<p>V/f CL-V/f OLV CLV AOLV OLV/PM AOLV/PM CLV/PM EZOLV</p> <p>Shows the frequency to pulse train input terminal RP. Unit: 1 Hz</p>	Determined by H6-02
U1-25 (004D)	SoftwareNumber Flash	<p>V/f CL-V/f OLV CLV AOLV OLV/PM AOLV/PM CLV/PM EZOLV</p> <p>Shows the FLASH ID.</p>	No signal output available
U1-26 (005B)	SoftwareNumber ROM	<p>V/f CL-V/f OLV CLV AOLV OLV/PM AOLV/PM CLV/PM EZOLV</p> <p>Shows the ROM ID.</p>	No signal output available
U1-50 (1199) Expert	Virtual Analog Input	<p>V/f CL-V/f OLV CLV AOLV OLV/PM AOLV/PM CLV/PM EZOLV</p> <p>Shows the virtual analog input value.</p>	Determined by H7-40
U1-91 (154E) Expert	Output Voltage	<p>V/f CL-V/f OLV CLV AOLV OLV/PM AOLV/PM CLV/PM EZOLV</p> <p>Shows the drive internal output voltage reference. Unit: 0.1 V</p>	200 V Class: 10 V = 200 Vrms 400 V Class: 10 V = 400 Vrms

◆ U2: Fault Trace

No. (Hex.)	Name	Description	MFAO Signal Level
U2-01 (0080)	Current Fault	<p>V/f CL-V/f OLV CLV AOLV OLV/PM AOLV/PM CLV/PM EZOLV</p> <p>Shows the fault that the drive has when viewing the monitor.</p>	No signal output available
U2-02 (0081)	Previous Fault	<p>V/f CL-V/f OLV CLV AOLV OLV/PM AOLV/PM CLV/PM EZOLV</p> <p>Shows the fault that occurred most recently.</p>	No signal output available
U2-03 (0082)	Freq Reference@Fault	<p>V/f CL-V/f OLV CLV AOLV OLV/PM AOLV/PM CLV/PM EZOLV</p> <p>Shows the frequency reference at the fault that occurred most recently. Use U1-01 [Frequency Reference] to monitor the frequency reference value. Unit: 0.01 Hz</p>	No signal output available
U2-04 (0083)	Output Freq @ Fault	<p>V/f CL-V/f OLV CLV AOLV OLV/PM AOLV/PM CLV/PM EZOLV</p> <p>Shows the output frequency at the fault that occurred most recently. Use U1-02 [Output Frequency] to monitor the actual output frequency. Unit: 0.01 Hz</p>	No signal output available
U2-05 (0084)	Output Current@Fault	<p>V/f CL-V/f OLV CLV AOLV OLV/PM AOLV/PM CLV/PM EZOLV</p> <p>Shows the output current at the fault that occurred most recently. Use U1-03 [Output Current] to monitor the output current. The keypad shows the value of U1-03 in amperes (A). When you use MEMOBUS/Modbus communications to show the monitor, the current is "8192 = drive rated current (A)". Use the formula: "Numerals being displayed / 8192 × drive rated current (A)" to use the MEMOBUS/Modbus communication current value shown in the monitor. Unit: When the drive model changes, the display units for this parameter also change.</p> <ul style="list-style-type: none"> 0.01 A: 2004 - 2042, 4002 - 4023 0.1 A: 2056 - 2415, 4031 - 4675 1 A: 4810 - 4H12 	No signal output available

11.17 U: Monitors

No. (Hex.)	Name	Description	MFAO Signal Level
U2-06 (0085)	Motor Speed @ Fault	<p>V/f CL-V/f OLV CLV AOLV OLV/IPM AOLV/IPM CLV/IPM EZOLV</p> <p>Shows the motor speed at the fault that occurred most recently. Use <i>U1-05 [Motor Speed]</i> to monitor the motor speed. Unit: 0.01 Hz</p>	No signal output available
U2-07 (0086)	Output Voltage@Fault	<p>V/f CL-V/f OLV CLV AOLV OLV/IPM AOLV/IPM CLV/IPM EZOLV</p> <p>Shows the output voltage reference at the fault that occurred most recently. Use <i>U1-06 [Output Voltage Ref]</i> to monitor the output voltage reference. Unit: 0.1 V</p>	No signal output available
U2-08 (0087)	DC Bus Voltage@Fault	<p>V/f CL-V/f OLV CLV AOLV OLV/IPM AOLV/IPM CLV/IPM EZOLV</p> <p>Shows the DC bus voltage at the fault that occurred most recently. Use <i>U1-07 [DC Bus Voltage]</i> to monitor the DC bus voltage. Unit: 1 V</p>	No signal output available
U2-09 (0088)	Output Power @ Fault	<p>V/f CL-V/f OLV CLV AOLV OLV/IPM AOLV/IPM CLV/IPM EZOLV</p> <p>Shows the output power at the fault that occurred most recently. Use <i>U1-08 [Output Power]</i> to monitor the output power. Unit: 0.1 kW</p>	No signal output available
U2-10 (0089)	Torque Ref @ Fault	<p>V/f CL-V/f OLV CLV AOLV OLV/IPM AOLV/IPM CLV/IPM EZOLV</p> <p>Shows the torque reference at the fault that occurred most recently as a percentage of the motor rated torque. Use <i>U1-09 [Torque Reference]</i> to monitor the torque reference. Unit: 0.1%</p>	No signal output available
U2-11 (008A)	Input Terminal Status @ Fault	<p>V/f CL-V/f OLV CLV AOLV OLV/IPM AOLV/IPM CLV/IPM EZOLV</p> <p>Shows the status of the MFDI terminals at the most recent fault where 1 = (ON) and 0 = (OFF). For example, <i>U2-11</i> shows "00000011" when terminals S1 and S2 are ON. Use <i>U1-10 [Input Terminal Status]</i> to monitor the MFDI terminal status. bit0 : Terminal S1 bit1 : Terminal S2 bit2 : Terminal S3 bit3 : Terminal S4 bit4 : Terminal S5 bit5 : Terminal S6 bit6 : Terminal S7 bit7 : Terminal S8</p>	No signal output available
U2-12 (008B)	Output Terminal Status @ Fault	<p>V/f CL-V/f OLV CLV AOLV OLV/IPM AOLV/IPM CLV/IPM EZOLV</p> <p>Shows the status of the MFDO terminals at the most recent fault where 1 = (ON) and 0 = (OFF). For example, <i>U2-12</i> shows "00000011" when terminals M1 and M3 are ON. Use <i>U1-11 [Output Terminal Status]</i> to monitor the MFDO terminal status. bit0 : Terminal M1-M2 bit1 : Terminal M3-M4 bit2 : Terminal M5-M6 bit3 : Not used (normal value of 0). bit4 : Not used (normal value of 0). bit5 : Not used (normal value of 0). bit6 : Not used (normal value of 0). bit7 : Fault relay MA/MB-MC</p>	No signal output available
U2-13 (008C)	Operation Status @ Fault	<p>V/f CL-V/f OLV CLV AOLV OLV/IPM AOLV/IPM CLV/IPM EZOLV</p> <p>Shows the status of the MFDO terminals at the most recent fault where 1 = (ON) and 0 = (OFF). For example, <i>U2-13</i> shows "00000001" during run. Use <i>U1-12 [Drive Status]</i> to monitor the MFDO terminal status. bit0 : During Run bit1 : During zero-speed bit2 : During reverse bit3 : During fault reset signal input bit4 : During speed agreement bit5 : Drive ready bit6 : During minor fault detection bit7 : During fault detection</p>	No signal output available
U2-14 (008D)	Elapsed Time @ Fault	<p>V/f CL-V/f OLV CLV AOLV OLV/IPM AOLV/IPM CLV/IPM EZOLV</p> <p>Shows the cumulative operation time of the drive at the fault that occurred most recently. Use <i>U4-01 [Cumulative Ope Time]</i> to monitor the cumulative operation time. Unit: 1 h</p>	No signal output available
U2-15 (07E0)	SFS Output @ Fault	<p>V/f CL-V/f OLV CLV AOLV OLV/IPM AOLV/IPM CLV/IPM EZOLV</p> <p>Shows the output frequency after soft start at the fault that occurred most recently. Use <i>U1-16 [SFS Output Frequency]</i> to monitor the output frequency after soft start. Unit: 0.01 Hz</p>	No signal output available

No. (Hex.)	Name	Description	MFAO Signal Level
U2-16 (07E1)	q-Axis Current@Fault	V/f CL-V/f OLV CLV AOLV OLV/PM AOLV/PM CLV/PM EZOLV Shows the q-Axis current of the motor at the fault that occurred most recently. Use U6-01 [<i>Iq Secondary Current</i>] to monitor the q-Axis current of the motor. Unit: 0.1 %	No signal output available
U2-17 (07E2)	d-Axis Current@Fault	V/f CL-V/f OLV CLV AOLV OLV/PM AOLV/PM CLV/PM EZOLV Shows the d-Axis current of the motor at the fault that occurred most recently. Use U6-02 [<i>Id Excitation Current</i>] to monitor the d-Axis current of the motor. Unit: 0.1%	No signal output available
U2-19 (07E4)	ControlDeviation@Flt	V/f CL-V/f OLV CLV AOLV OLV/PM AOLV/PM CLV/PM EZOLV Shows the amount of control axis deviation ($\Delta\theta$) at the fault that occurred most recently. Use U6-10 [<i>ContAxisDeviation $\Delta\theta$</i>] to monitor the actual amount of control axis deviation ($\Delta\theta$). Unit: 0.1 °	No signal output available
U2-20 (008E)	Heatsink Temp @Fault	V/f CL-V/f OLV CLV AOLV OLV/PM AOLV/PM CLV/PM EZOLV Shows the heatsink temperature at the fault that occurred most recently. Use U4-08 [<i>Heatsink Temperature</i>] to monitor the temperature of the heatsink. Unit: 1 °C	No signal output available
U2-21 (1166) Expert	STPo Detect @ Fault	V/f CL-V/f OLV CLV AOLV OLV/PM AOLV/PM CLV/PM EZOLV Monitors conditions to detect STPo [<i>Motor Step-Out Detected</i>] faults. The bit for each condition is shown as ON or OFF. bit0 : Excessive current bit1 : Induced voltage deviation bit2 : d-axis current deviation bit3 : Motor lock at startup bit4 : Acceleration stall continue bit5 : Acceleration stall repeat bit6 : Not used (normal value of 0). bit7 : Not used (normal value of 0).	No signal output available

◆ U3: Fault History

No. (Hex.)	Name	Description	MFAO Signal Level
U3-01 (0090)	1st MostRecent Fault	V/f CL-V/f OLV CLV AOLV OLV/PM AOLV/PM CLV/PM EZOLV Shows the fault history of the most recent fault. Note: The drive saves this fault history to two types of registers at the same time for the MEMOBUS/Modbus communications.	No signal output available
U3-02 (0091)	2nd MostRecent Fault	V/f CL-V/f OLV CLV AOLV OLV/PM AOLV/PM CLV/PM EZOLV Shows the fault history of the second most recent fault. Note: The drive saves this fault history to two types of registers at the same time for the MEMOBUS/Modbus communications.	No signal output available
U3-03 (0092)	3rd MostRecent Fault	V/f CL-V/f OLV CLV AOLV OLV/PM AOLV/PM CLV/PM EZOLV Shows the fault history of the third most recent fault. Note: The drive saves this fault history to two types of registers at the same time for the MEMOBUS/Modbus communications.	No signal output available
U3-04 (0093)	4th MostRecent Fault	V/f CL-V/f OLV CLV AOLV OLV/PM AOLV/PM CLV/PM EZOLV Shows the fault history of the fourth most recent fault. Note: The drive saves this fault history to two types of registers at the same time for the MEMOBUS/Modbus communications.	No signal output available
U3-05 (0804)	5th MostRecent Fault	V/f CL-V/f OLV CLV AOLV OLV/PM AOLV/PM CLV/PM EZOLV Shows the fault history of the fifth most recent fault.	No signal output available
U3-06 (0805)	6th MostRecent Fault	V/f CL-V/f OLV CLV AOLV OLV/PM AOLV/PM CLV/PM EZOLV Shows the fault history of the sixth most recent fault.	No signal output available
U3-07 (0806)	7th MostRecent Fault	V/f CL-V/f OLV CLV AOLV OLV/PM AOLV/PM CLV/PM EZOLV Shows the fault history of the seventh most recent fault.	No signal output available
U3-08 (0807)	8th MostRecent Fault	V/f CL-V/f OLV CLV AOLV OLV/PM AOLV/PM CLV/PM EZOLV Shows the fault history of the eighth most recent fault.	No signal output available
U3-09 (0808)	9th MostRecent Fault	V/f CL-V/f OLV CLV AOLV OLV/PM AOLV/PM CLV/PM EZOLV Shows the fault history of the ninth most recent fault.	No signal output available
U3-10 (0809)	10th MostRecentFault	V/f CL-V/f OLV CLV AOLV OLV/PM AOLV/PM CLV/PM EZOLV Shows the fault history of the tenth most recent fault.	No signal output available

No. (Hex.)	Name	Description	MFAO Signal Level
U3-11 (0094)	ElapsedTime@1stFault	<p>V/f CL-V/f OLV CLV AOLV OLV/PM AOLV/PM CLV/PM EZOLV</p> <p>Shows the cumulative operation time when the most recent fault occurred.</p> <p>Note: The drive saves this cumulative operation time to two types of registers at the same time for the MEMOBUS/Modbus communications. Unit: 1 h</p>	No signal output available
U3-12 (0095)	ElapsedTime@2ndFault	<p>V/f CL-V/f OLV CLV AOLV OLV/PM AOLV/PM CLV/PM EZOLV</p> <p>Shows the cumulative operation time when the second most recent fault occurred.</p> <p>Note: The drive saves this cumulative operation time to two types of registers at the same time for the MEMOBUS/Modbus communications. Unit: 1 h</p>	No signal output available
U3-13 (0096)	ElapsedTime@3rdFault	<p>V/f CL-V/f OLV CLV AOLV OLV/PM AOLV/PM CLV/PM EZOLV</p> <p>Shows the cumulative operation time when the third most recent fault occurred.</p> <p>Note: The drive saves this cumulative operation time to two types of registers at the same time for the MEMOBUS/Modbus communications. Unit: 1 h</p>	No signal output available
U3-14 (0097)	ElapsedTime@4thFault	<p>V/f CL-V/f OLV CLV AOLV OLV/PM AOLV/PM CLV/PM EZOLV</p> <p>Shows the cumulative operation time when the fourth most recent fault occurred.</p> <p>Note: The drive saves this cumulative operation time to two types of registers at the same time for the MEMOBUS/Modbus communications. Unit: 1 h</p>	No signal output available
U3-15 (080E)	ElapsedTime@5thFault	<p>V/f CL-V/f OLV CLV AOLV OLV/PM AOLV/PM CLV/PM EZOLV</p> <p>Shows the cumulative operation time when the fifth most recent fault occurred. Unit: 1 h</p>	No signal output available
U3-16 (080F)	ElapsedTime@6thFault	<p>V/f CL-V/f OLV CLV AOLV OLV/PM AOLV/PM CLV/PM EZOLV</p> <p>Shows the cumulative operation time when the sixth most recent fault occurred. Unit: 1 h</p>	No signal output available
U3-17 (0810)	ElapsedTime@7thFault	<p>V/f CL-V/f OLV CLV AOLV OLV/PM AOLV/PM CLV/PM EZOLV</p> <p>Shows the cumulative operation time when the seventh most recent fault occurred. Unit: 1 h</p>	No signal output available
U3-18 (0811)	ElapsedTime@8thFault	<p>V/f CL-V/f OLV CLV AOLV OLV/PM AOLV/PM CLV/PM EZOLV</p> <p>Shows the cumulative operation time when the eighth most recent fault occurred. Unit: 1 h</p>	No signal output available
U3-19 (0812)	ElapsedTime@9thFault	<p>V/f CL-V/f OLV CLV AOLV OLV/PM AOLV/PM CLV/PM EZOLV</p> <p>Shows the cumulative operation time when the ninth most recent fault occurred. Unit: 1 h</p>	No signal output available
U3-20 (0813)	ElapsedTime@10 Fault	<p>V/f CL-V/f OLV CLV AOLV OLV/PM AOLV/PM CLV/PM EZOLV</p> <p>Shows the cumulative operation time when the tenth most recent fault occurred. Unit: 1 h</p>	No signal output available

◆ U4: Maintenance Monitors

No. (Hex.)	Name	Description	MFAO Signal Level
U4-01 (004C)	Cumulative Ope Time	<p>V/f CL-V/f OLV CLV AOLV OLV/PM AOLV/PM CLV/PM EZOLV</p> <p>Shows the cumulative operation time of the drive.</p> <p>Use parameter <i>o4-01 [Elapsed Operating Time Setting]</i> to reset this monitor. Use parameter <i>o4-02 [Elapsed Operating Time Selection]</i> to select the cumulative operation times from:</p> <ul style="list-style-type: none"> The time from when the drive is energized until it is de-energized. The time at which the Run command is turned ON. <p>The maximum value that the monitor will show is 99999. After this value is more than 99999, the drive automatically resets it and starts to count from 0 again. Unit: 1 h</p> <p>Note: The MEMOBUS/Modbus communication data is shown in 10 h units. Use register 0099H for data in 1 h units.</p>	10 V: 99999 h
U4-02 (0075)	Num of Run Commands	<p>V/f CL-V/f OLV CLV AOLV OLV/PM AOLV/PM CLV/PM EZOLV</p> <p>Shows how many times that the drive has received a Run command.</p> <p>Use parameter <i>o4-13 [RUN Command Counter @ Initialize]</i> to reset this monitor. The maximum value that the monitor will show is 65535. After this value is more than 65535, the drive automatically resets it and starts to count from 0 again. Unit: 1</p>	10 V: 65535 times

No. (Hex.)	Name	Description	MFAO Signal Level
U4-03 (0067)	Cooling Fan Ope Time	<p>V/f CL-V/f OLV CLV AOLV OLV/PM AOLV/PM CLV/PM EZOLV</p> <p>Shows the cumulative operation time of the cooling fans.</p> <p>Use parameter <i>o4-03</i> [<i>Fan Operation Time Setting</i>] to reset this monitor. The maximum value that the monitor will show is 99999. After this value is more than 99999, the drive automatically resets it and starts to count from 0 again.</p> <p>Unit: 1 h</p> <p>Note: The MEMOBUS/Modbus communication data is shown in 10 h units. Use register 009BH for data in 1 h units.</p>	10 V: 99999 h
U4-04 (007E)	Cool Fan Maintenance	<p>V/f CL-V/f OLV CLV AOLV OLV/PM AOLV/PM CLV/PM EZOLV</p> <p>Shows the cumulative operation time of the cooling fans as a percentage of the estimated performance life of the cooling fans.</p> <p>The default value is 0. The value counts up from 0.</p> <p>Use <i>o4-03</i> [<i>Fan Operation Time Setting</i>] to reset this monitor.</p> <p>Unit: 1%</p> <p>Note: Replace the cooling fans when this monitor is at 90%.</p>	10 V: 100%
U4-05 (007C)	CapacitorMaintenance	<p>V/f CL-V/f OLV CLV AOLV OLV/PM AOLV/PM CLV/PM EZOLV</p> <p>Shows the operation time of the electrolytic capacitors for the main circuit and control circuit as a percentage of the estimated performance life of the electrolytic capacitors.</p> <p>The default value is 0. The value counts up from 0.</p> <p>Use <i>o4-05</i> [<i>Capacitor Maintenance Setting</i>] to reset this monitor.</p> <p>Unit: 1%</p> <p>Note: Replace the electrolytic capacitor when this monitor is at 90%.</p>	10 V: 100%
U4-06 (07D6)	PreChargeRelayMainte	<p>V/f CL-V/f OLV CLV AOLV OLV/PM AOLV/PM CLV/PM EZOLV</p> <p>Shows the operation time of the soft charge bypass relay as a percentage of the estimated performance life of the soft charge bypass relay.</p> <p>The default value is 0. The value counts up from 0.</p> <p>Use <i>o4-07</i> [<i>Softcharge Relay Maintenance Set</i>] to reset this monitor.</p> <p>Unit: 1%</p> <p>Note: Replace the drive when this monitor is at 90%.</p>	10 V: 100%
U4-07 (07D7)	IGBT Maintenance	<p>V/f CL-V/f OLV CLV AOLV OLV/PM AOLV/PM CLV/PM EZOLV</p> <p>Shows the operation time of the IGBTs as a percentage of the estimated performance life of the IGBTs.</p> <p>The default value is 0. The value counts up from 0.</p> <p>Use <i>o4-09</i> [<i>IGBT Maintenance Setting</i>] to reset this monitor.</p> <p>Unit: 1%</p> <p>Note: Replace the drive when this monitor is at 90%.</p>	10 V: 100%
U4-08 (0068)	Heatsink Temperature	<p>V/f CL-V/f OLV CLV AOLV OLV/PM AOLV/PM CLV/PM EZOLV</p> <p>Shows the heatsink temperature of the drive.</p> <p>Unit: 1 °C</p>	10 V: 100 °C
U4-09 (005E)	LED Check	<p>V/f CL-V/f OLV CLV AOLV OLV/PM AOLV/PM CLV/PM EZOLV</p> <p>Turns on the LED Status Ring and all of the keypad LEDs to make sure that the LEDs operate correctly.</p> <p>Note: A damaged LED Status Ring board will prevent an accurate estimate of the internal status of the drive. Do not use only the LED Status Ring to estimate the status of the drive and motors.</p> <ol style="list-style-type: none"> Set <i>o2-24</i> = 0 [<i>LED Light Function Selection = Enable Status Ring & Keypad LED</i>]. Push  when <i>U4-09</i> is the top monitor shown on the keypad. All LEDs on the keypad and LED Status Ring will turn on. <p>Note: When Safety input 2 CH is open (STo), READY will flash.</p>	No signal output available
U4-10 (005C)	kWh, Lower 4 Digits	<p>V/f CL-V/f OLV CLV AOLV OLV/PM AOLV/PM CLV/PM EZOLV</p> <p>Shows the lower 4 digits of the watt hour value for the drive.</p> <p>Unit: 1 kWh</p> <p>Note: The watt hour is displayed in 9 digits. Monitor <i>U4-11</i> [<i>kWh, Upper 5 Digits</i>] shows the upper 5 digits and <i>U4-10</i> shows the lower 4 digits. Example for 12345678.9 kWh: <i>U4-10</i>: 678.9 kWh <i>U4-11</i>: 12345 MWh</p>	No signal output available

11.17 U: Monitors

No. (Hex.)	Name	Description	MFAO Signal Level
U4-11 (005D)	kWh, Upper 5 Digits	<p>V/f CL-V/f OLV CLV AOLV OLV/IPM AOLV/IPM CLV/IPM EZOLV</p> <p>Shows the upper 5 digits of the watt hour value for the drive. Unit: 1 MWh Note: Monitor <i>U4-11</i> shows the upper 5 digits and <i>U4-10 [kWh, Lower 4 Digits]</i> shows the lower 4 digits. Example for 12345678.9 kWh: <i>U4-10</i>: 678.9 kWh <i>U4-11</i>: 12345 MWh</p>	No signal output available
U4-13 (07CF)	Peak Hold Current	<p>V/f CL-V/f OLV CLV AOLV OLV/IPM AOLV/IPM CLV/IPM EZOLV</p> <p>Shows the hold value of the peak value (rms) for the drive output current. Use <i>U4-14 [PeakHold Output Freq]</i> to show the drive output frequency at the time that the drive holds the output current. The drive will hold the peak hold current at the next start up and restart of the power supply. The drive keeps the value that was under hold during baseblock (during stop). The keypad shows the value of <i>U4-13</i> in amperes (A). When you use MEMOBUS/Modbus communications to show the monitor, the current is "8192 = drive rated current (A)". Use the formula: "Numerals being displayed / 8192 × drive rated current (A)" to use the MEMOBUS/Modbus communication current value shown in the monitor. Unit: When the drive model changes, the display units for this parameter also change. • 0.01 A: 2004 - 2042, 4002 - 4023 • 0.1 A: 2056 - 2415, 4031 - 4675 • 1 A: 4810 - 4H12</p>	No signal output available
U4-14 (07D0)	PeakHold Output Freq	<p>V/f CL-V/f OLV CLV AOLV OLV/IPM AOLV/IPM CLV/IPM EZOLV</p> <p>Shows the output frequency at which the peak value (rms) of the drive output current is held. The peak hold current can be monitored by <i>U4-13 [Peak Hold Current]</i>. The peak hold output frequency will be cleared at the next startup and restart of the power supply. The drive keeps the value that was under hold during baseblock (during stop). Unit: 0.01 Hz</p>	No signal output available
U4-16 (07D8)	Motor oL1 Level	<p>V/f CL-V/f OLV CLV AOLV OLV/IPM AOLV/IPM CLV/IPM EZOLV</p> <p>Shows the integrated value of <i>oL1 [Motor Overload]</i> as a percentage of <i>oL1</i> detection level. Unit: 0.1%</p>	10 V: 100%
U4-18 (07DA)	Reference Source	<p>V/f CL-V/f OLV CLV AOLV OLV/IPM AOLV/IPM CLV/IPM EZOLV</p> <p>Shows the selected frequency reference source. The keypad shows the frequency reference source as "XY-nn" as specified by these rules: X: External Reference 1/2 Selection [<i>H1-xx = 2</i>] selection status • 1: <i>b1-01 [Frequency Reference Selection 1]</i> • 2: <i>b1-15 [Frequency Reference Selection 2]</i> Y-nn: Frequency reference source • 0-01: Keypad (<i>d1-01 [Reference 1]</i>) • 1-00: Analog input (unassigned) • 1-01: MFAI terminal A1 • 1-02: MFAI terminal A2 • 1-03: MFAI terminal A3 • 2-02 to 2-17: Multi-step speed reference (<i>d1-02 to d1-17 [Reference 2 to 16, Jog Reference]</i>) • 3-01: MEMOBUS/Modbus communications • 4-01: Communication option card • 5-01: Pulse train input • 7-01: DriveWorksEZ • 9-01: Up/Down command</p>	No signal output available
U4-19 (07DB)	Modbus FreqRef(dec)	<p>V/f CL-V/f OLV CLV AOLV OLV/IPM AOLV/IPM CLV/IPM EZOLV</p> <p>Shows the frequency reference sent to the drive from the MEMOBUS/Modbus communications as a decimal. Unit: 0.01%</p>	10 V: Maximum frequency (0 V to +10 V)
U4-20 (07DC)	Option Freq Ref(dec)	<p>V/f CL-V/f OLV CLV AOLV OLV/IPM AOLV/IPM CLV/IPM EZOLV</p> <p>Shows the frequency reference sent to the drive from the communication option as a decimal. Unit: 0.01 %</p>	10 V: Maximum frequency (0 V to +10 V)

No. (Hex.)	Name	Description	MFAO Signal Level
U4-21 (07DD)	Run Command Source	<p>V/f CL-V/f OLV CLV AOLV OLV/PM AOLV/PM CLV/PM EZOLV</p> <p>Shows the selected Run command source. The keypad shows the Run command source as "XY-nn" as specified by these rules: X: External Reference 1/2 Selection [H1-xx = 2] selection status</p> <ul style="list-style-type: none"> • 1: b1-02 [Run Command Selection 1] • 2: b1-16 [Run Command Selection 2] <p>Y: Run command source</p> <ul style="list-style-type: none"> • 0: Keypad • 1: Control circuit terminal • 3: MEMOBUS/Modbus communications • 4: Communication option card • 7: DriveWorksEZ <p>nn: Run command limit status data</p> <ul style="list-style-type: none"> • 00: No limit status. • 01: The Run command was left ON when the drive stopped in the Programming Mode. • 02: The Run command was left ON when switching from LOCAL Mode to REMOTE Mode. • 03: The Run command is in standby after the drive was energized until the soft charge bypass contactor turns ON. <p>Note: The drive will detect <i>Uv1</i> [DC Bus Undervoltage] or <i>Uv</i> [Undervoltage] if the soft charge bypass contactor does not turn ON after 10 s.</p> <ul style="list-style-type: none"> • 04: Restart after run stop is prohibited. • 05: Fast stop has been executed using the MFDI terminal. Or, the motor has ramped to stop by pressing the STOP key on the keypad. • 06: b1-17 = 0 [Run Command at Power Up = Disregard Existing RUN Command] is set. • 07: During baseblock while coast to stop with timer. • 08: Frequency reference is below E1-09 [Minimum Output Frequency] during baseblock. • 09: Waiting for the Enter command from PLC. 	No signal output The keypad shows the Run command source as "XY-nn" as specified by these rules: available
U4-22 (07DE)	Modbus CmdData (hex)	<p>V/f CL-V/f OLV CLV AOLV OLV/PM AOLV/PM CLV/PM EZOLV</p> <p>Shows the operation signal (register 0001H) sent to the drive from MEMOBUS/Modbus communications as a 4-digit hexadecimal number (zero suppress). The keypad shows the operation signal as specified by these rules:</p> <p>bit0 : Forward run/Stop bit1 : Reverse run/Stop bit2 : External fault bit3 : Fault Reset bit4 : Multi-function input 1 bit5 : Multi-function input 2 bit6 : Multi-function input 3 bit7 : Multi-function input 4 bit8 : Multi-function input 5 bit9 : Multi-function input 6 bitA : Multi-function input 7 bitB : Multi-function input 8 bitC : Not used (normal value of 0). bitD : Not used (normal value of 0). bitE : Not used (normal value of 0). bitF : Not used (normal value of 0).</p>	No signal output available
U4-23 (07DF)	Option CmdData (hex)	<p>V/f CL-V/f OLV CLV AOLV OLV/PM AOLV/PM CLV/PM EZOLV</p> <p>Shows the operation signal (register 0001H) sent to the drive from MEMOBUS/Modbus communications as a 4-digit hexadecimal number. The keypad shows the operation signal as specified by these rules:</p> <p>bit 0 : Forward run/Stop bit 1 : Reverse run/Stop bit 2 : External fault bit 3 : Fault Reset bit 4 : Multi-function input 1 bit 5 : Multi-function input 2 bit 6 : Multi-function input 3 bit 7 : Multi-function input 4 bit 8 : Multi-function input 5 bit 9 : Multi-function input 6 bit A : Multi-function input 7 bit B : Multi-function input 8 bit C : Not used (normal value of 0). bit D : Not used (normal value of 0). bit E : Not used (normal value of 0). bit F : Not used (normal value of 0).</p>	No signal output available

11.17 U: Monitors

No. (Hex.)	Name	Description	MFAO Signal Level
U4-24 (07E6)	Number of Runs (Low)	<p>V/f CL-V/f OLV CLV AOLV OLV/PM AOLV/PM CLV/PM EZOLV</p> <p>Shows the lower 4 digits of the drive run count.</p> <p>Note: The drive run count is an 8-digit number. Monitor <i>U4-25 [Number of Runs(High)]</i> shows the upper 4 digits and <i>U4-24</i> shows the lower 4 digits.</p>	No signal output available
U4-25 (07E7)	Number of Runs(High)	<p>V/f CL-V/f OLV CLV AOLV OLV/PM AOLV/PM CLV/PM EZOLV</p> <p>Shows the upper 4 digits of the drive run count.</p> <p>Note: The drive run count is an 8-digit number. Monitor <i>U4-25</i> shows the upper 4 digits and <i>U4-24 [Number of Runs (Low)]</i> shows the lower 4 digits.</p>	No signal output available
U4-52 (1592)	Torque Ref from Comm	<p>V/f CL-V/f OLV CLV AOLV OLV/PM AOLV/PM CLV/PM EZOLV</p> <p>Shows the torque reference that the drive received from a serial communication option card or from MEMOBUS/Modbus communications as a decimal number.</p> <p>Unit: 0.1%</p>	10 V: 100% (0 V to +10 V)
U4-75 (1BC4)	Comm Option Type	<p>V/f CL-V/f OLV CLV AOLV OLV/PM AOLV/PM CLV/PM EZOLV</p> <p>Shows the protocol of the communication option currently connected to the drive.</p> <p>1 : Modbus TCP/IP (SI-EM3) 2 : EtherNet/IP (SI-EN3) or PROFINET (SI-EP3) 4 : EtherCAT (SI-ES3) 8 : CC-Link (SI-C3) 9 : DeviceNet (SI-N3) A : PROFIBUS-DP (SI-P3) B : CANopen (SI-S3) D : MECHATROLINK-II (SI-T3) 11 : LONWORKS (SI-W3) 12 : MECHATROLINK-III (SI-ET3) 70 : Protocol not set (JOHB-SMP3) 71 : Modbus TCP/IP (JOHB-SMP3) 72 : EtherNet/IP (JOHB-SMP3) 74 : EtherCAT (JOHB-SMP3) 78 : PROFINET (JOHB-SMP3) FF : Communication Option not Connected</p>	No signal output available
U4-76 (1BC5)	MAC Address 1 1, 2	<p>V/f CL-V/f OLV CLV AOLV OLV/PM AOLV/PM CLV/PM EZOLV</p> <p>Shows the first and second octets of MAC address 1.</p> <p>Note: This monitor is for JOHB-SMP3. When you connect a communication option that is not a JOHB-SMP3, the drive shows "00-00".</p>	No signal output available
U4-77 (1BC6)	MAC Address 1 3, 4	<p>V/f CL-V/f OLV CLV AOLV OLV/PM AOLV/PM CLV/PM EZOLV</p> <p>Shows the third and fourth octets of MAC address 1.</p> <p>Note: This monitor is for JOHB-SMP3. When you connect a communication option that is not a JOHB-SMP3, the drive shows "00-00".</p>	No signal output available
U4-78 (1BC7)	MAC Address 1 5, 6	<p>V/f CL-V/f OLV CLV AOLV OLV/PM AOLV/PM CLV/PM EZOLV</p> <p>Shows the fifth and sixth octets of MAC address 1.</p> <p>Note: This monitor is for JOHB-SMP3. When you connect a communication option that is not a JOHB-SMP3, the drive shows "00-00".</p>	No signal output available
U4-79 (1BC8) Expert	MAC Address 2 1, 2	<p>V/f CL-V/f OLV CLV AOLV OLV/PM AOLV/PM CLV/PM EZOLV</p> <p>Shows the first and second octets of MAC address 2.</p> <p>Note: This monitor is for JOHB-SMP3. When you connect a communication option that is not a JOHB-SMP3, the drive shows "00-00".</p>	No signal output available
U4-80 (1BC9) Expert	MAC Address 2 3, 4	<p>V/f CL-V/f OLV CLV AOLV OLV/PM AOLV/PM CLV/PM EZOLV</p> <p>Shows the third and fourth octets of MAC address 2.</p> <p>Note: This monitor is for JOHB-SMP3. When you connect a communication option that is not a JOHB-SMP3, the drive shows "00-00".</p>	No signal output available
U4-81 (1BCA) Expert	MAC Address 2 5, 6	<p>V/f CL-V/f OLV CLV AOLV OLV/PM AOLV/PM CLV/PM EZOLV</p> <p>Shows the fifth and sixth octets of MAC address 2.</p> <p>Note: This monitor is for JOHB-SMP3. When you connect a communication option that is not a JOHB-SMP3, the drive shows "00-00".</p>	No signal output available

No. (Hex.)	Name	Description	MFAO Signal Level
U4-82 (1BCB) Expert	MAC Address 3 1, 2	V/f CL-V/f OLV CLV AOLV OLV/PM AOLV/PM CLV/PM EZOLV Shows the first and second octets of MAC address 3. Note: This monitor is for JOHB-SMP3. When you connect a communication option that is not a JOHB-SMP3, the drive shows "00-00".	No signal output available
U4-83 (1BCC) Expert	MAC Address 3 3, 4	V/f CL-V/f OLV CLV AOLV OLV/PM AOLV/PM CLV/PM EZOLV Shows the third and fourth octets of MAC address 3. Note: This monitor is for JOHB-SMP3. When you connect a communication option that is not a JOHB-SMP3, the drive shows "00-00".	No signal output available
U4-84 (1BCD) Expert	MAC Address 3 5, 6	V/f CL-V/f OLV CLV AOLV OLV/PM AOLV/PM CLV/PM EZOLV Shows the fifth and sixth octets of MAC address 3. Note: This monitor is for JOHB-SMP3. When you connect a communication option that is not a JOHB-SMP3, the drive shows "00-00".	No signal output available

◆ U5: PID Monitors

No. (Hex.)	Name	Description	MFAO Signal Level
U5-01 (0057)	PID Feedback	V/f CL-V/f OLV CLV AOLV OLV/PM AOLV/PM CLV/PM EZOLV Shows the PID control feedback value. Parameter <i>b5-20 [PID Unit Selection]</i> sets the display units. Unit: 0.01%	10 V: Maximum frequency (0 V to +10 V)
U5-02 (0063)	PID Input	V/f CL-V/f OLV CLV AOLV OLV/PM AOLV/PM CLV/PM EZOLV Shows the change between the PID setpoint and PID feedback (the quantity of PID input) as a percentage of the maximum output frequency. Unit: 0.01%	10 V: Maximum frequency (0 V to +10 V)
U5-03 (0064)	PID Output	V/f CL-V/f OLV CLV AOLV OLV/PM AOLV/PM CLV/PM EZOLV Shows the PID control output as a percentage of the maximum output frequency. Unit: 0.01%	10 V: Maximum frequency (0 V to +10 V)
U5-04 (0065)	PID Setpoint	V/f CL-V/f OLV CLV AOLV OLV/PM AOLV/PM CLV/PM EZOLV Shows the PID setpoint. Parameter <i>b5-20 [PID Unit Selection]</i> sets the display units. Unit: 0.01%	10 V: Maximum frequency (0 V to +10 V)
U5-05 (07D2)	PID DifferentialFdbk	V/f CL-V/f OLV CLV AOLV OLV/PM AOLV/PM CLV/PM EZOLV Shows the PID differential feedback value as a percentage of the maximum output frequency. This monitor is available after you set <i>H3-02, H3-10, or H3-06 = 16 [MFAI Function Selection = Differential PID Feedback]</i> . Unit: 0.01%	10 V = Maximum frequency (-10 V to +10 V)
U5-06 (07D3)	PID Fdbk-Diff PID Fdbk	V/f CL-V/f OLV CLV AOLV OLV/PM AOLV/PM CLV/PM EZOLV Shows the difference from calculating <i>U5-05 - U5-01 [PID DifferentialFdbk] - [PID Feedback]</i> . Unit: 0.01% Note: <i>U5-01 [PID Feedback] = U5-06</i> when <i>H3-02, H3-10, or H3-06 ≠ 16 [MFAI Function Selection ≠ Differential PID Feedback]</i> .	10 V = Maximum frequency (-10 V to +10 V)
U5-21 (0872) Expert	Energy Save Coeff Ki	V/f CL-V/f OLV CLV AOLV OLV/PM AOLV/PM CLV/PM EZOLV Shows the energy-saving coefficient Ki value for PM. Unit: 0.01	No signal output available
U5-22 (0873) Expert	Energy Save Coeff Kt	V/f CL-V/f OLV CLV AOLV OLV/PM AOLV/PM CLV/PM EZOLV Shows the energy-saving coefficient Kt value for PM. Unit: 0.01	No signal output available
U5-99 (1599)	PID Setpoint Command	V/f CL-V/f OLV CLV AOLV OLV/PM AOLV/PM CLV/PM EZOLV Shows the PID setpoint command. Parameter <i>b5-20 [PID Unit Selection]</i> sets the display units. Unit: 0.01%	10 V: Maximum frequency (0 V to +10 V)

◆ U6: Operation Status Monitors

No. (Hex.)	Name	Description	MFAO Signal Level
U6-01 (0051)	Iq Secondary Current	V/f CL-V/f OLV CLV AOLV OLV/PM AOLV/PM CLV/PM EZOLV Shows the value calculated for the motor secondary current (q-Axis) as a percentage of the motor rated secondary current. Unit: 0.1%	10 V: Motor secondary rated current (0 V to +10 V)
U6-02 (0052)	Id ExcitationCurrent	V/f CL-V/f OLV CLV AOLV OLV/PM AOLV/PM CLV/PM EZOLV Shows the value calculated for the motor excitation current (d-Axis) as a percentage of the motor rated secondary current. Unit: 0.1%	10 V: Motor secondary rated current (0 V to +10 V)
U6-03 (0054)	ASR Input	V/f CL-V/f OLV CLV AOLV OLV/PM AOLV/PM CLV/PM EZOLV Shows the ASR input value as a percentage of the maximum frequency. Unit: 0.01%	10 V: Maximum frequency (0 V to +10 V)
U6-04 (0055)	ASR Output	V/f CL-V/f OLV CLV AOLV OLV/PM AOLV/PM CLV/PM EZOLV Shows the ASR output value as a percentage of the motor rated secondary current. Unit: 0.01%	10 V: Motor secondary rated current (0 V to +10 V)
U6-05 (0059)	OutputVoltageRef: Vq	V/f CL-V/f OLV CLV AOLV OLV/PM AOLV/PM CLV/PM EZOLV Shows the drive internal voltage reference for motor secondary current control (q-Axis). Unit: 0.1 V	200 V Class: 10 V = 200 Vrms 400 V Class: 10 V = 400 Vrms (0 V to +10 V)
U6-06 (005A)	OutputVoltageRef: Vd	V/f CL-V/f OLV CLV AOLV OLV/PM AOLV/PM CLV/PM EZOLV Shows the drive internal voltage reference for motor excitation current control (d-Axis). Unit: 0.1 V	200 V Class: 10 V = 200 Vrms 400 V Class: 10 V = 400 Vrms (0 V to +10 V)
U6-07 (005F) Expert	q-Axis ACR Output	V/f CL-V/f OLV CLV AOLV OLV/PM AOLV/PM CLV/PM EZOLV Shows the output value for current control related to motor secondary current (q axis). Unit: 0.1 %	200 V Class: 10 V = 200 Vrms 400 V Class: 10 V = 400 Vrms (0 V to +10 V)
U6-08 (0060) Expert	d-Axis ACR Output	V/f CL-V/f OLV CLV AOLV OLV/PM AOLV/PM CLV/PM EZOLV Shows the output value for current control related to motor excitation current (d axis). Unit: 0.1 %	200 V Class: 10 V = 200 Vrms 400 V Class: 10 V = 400 Vrms (0 V to +10 V)
U6-09 (07C0) Expert	AdvPhase Compn Δθcmp	V/f CL-V/f OLV CLV AOLV OLV/PM AOLV/PM CLV/PM EZOLV Displays the data on forward phase compensation for the calculation results of the amount of control axis deviation. Unit: 1 °	5 V: 180 ° (-10 V to +10 V)
U6-10 (07C1) Expert	ContAxisDeviation Δθ	V/f CL-V/f OLV CLV AOLV OLV/PM AOLV/PM CLV/PM EZOLV Shows the deviation between the γδ-Axis that the drive uses for motor control and the dq-Axis. Unit: 0.1 °	5 V: 180 ° (-10 V to +10 V)
U6-13 (07CA) Expert	MagPolePosition(Enc)	V/f CL-V/f OLV CLV AOLV OLV/PM AOLV/PM CLV/PM EZOLV Shows the value of the flux position detection. Unit: 0.1 °	10 V: 180° (-10 V to +10 V)
U6-14 (07CB) Expert	MagPolePosition(Obs)	V/f CL-V/f OLV CLV AOLV OLV/PM AOLV/PM CLV/PM EZOLV Shows the value of the flux position estimation. Unit: 0.1 °	10 V: 180 ° (-10 V to +10 V)
U6-17 (07D1) Expert	Energy Save Coeff	V/f CL-V/f OLV CLV AOLV OLV/PM AOLV/PM CLV/PM EZOLV Shows the total time of direction of motor rotation detections for Speed Estimation Speed Searches. This value adjusts b3-26 [Direction Determination Level]. Note: Upper limit is +32767 and lower limit is -32767.	No signal output available
U6-18 (07CD)	Enc 1 Pulse Counter	V/f CL-V/f OLV CLV AOLV OLV/PM AOLV/PM CLV/PM EZOLV Shows the number of pulses for speed detection (PG1). Unit: 1 pulse	10 V: 65536
U6-19 (07E5)	Enc 2 Pulse Counter	V/f CL-V/f OLV CLV AOLV OLV/PM AOLV/PM CLV/PM EZOLV Shows the number of pulses for speed detection (PG2). Unit: 1 pulse	10 V: 65536
U6-20 (07D4)	UP/DOWN 2 Bias Value	V/f CL-V/f OLV CLV AOLV OLV/PM AOLV/PM CLV/PM EZOLV Shows the bias value used to adjust the frequency reference. Unit: 0.1%	10 V: Maximum Frequency
U6-21 (07D5)	Offset Frequency	V/f CL-V/f OLV CLV AOLV OLV/PM AOLV/PM CLV/PM EZOLV Shows the total value of d7-01 to d7-03 [Offset Frequency 1 to 3] selected with Add Offset Frequency 1 to 3 [H1-xx = 44 to 46]. Unit: 0.1%	10 V: Maximum Frequency

No. (Hex.)	Name	Description	MFAO Signal Level
U6-22 (0062)	ZeroServo Pulse Move	<input type="checkbox"/> V/f <input type="checkbox"/> CL-V/f <input type="checkbox"/> OLV <input checked="" type="checkbox"/> CLV <input type="checkbox"/> AOLV <input type="checkbox"/> OLV/PM <input type="checkbox"/> AOLV/PM <input type="checkbox"/> CLV/PM <input type="checkbox"/> EZOLV Shows the distance that the rotor moved from its last position when Zero Servo is available. The value shown in this monitor = 4 X [No. of PG pulses]. Unit: 1 pulse	10 V = Number of pulses per revolution (-10 V to +10 V)
U6-25 (006B) Expert	ASR Output Level	<input type="checkbox"/> V/f <input type="checkbox"/> CL-V/f <input type="checkbox"/> OLV <input checked="" type="checkbox"/> CLV <input type="checkbox"/> AOLV <input type="checkbox"/> OLV/PM <input type="checkbox"/> AOLV/PM <input type="checkbox"/> CLV/PM <input type="checkbox"/> EZOLV Shows the primary delay filter input value of the ASR (speed control loop). Unit: 0.01%	10 V = Motor secondary rated current (-10 V to +10 V)
U6-26 (006C) Expert	Feed Fwd Cont Output	<input type="checkbox"/> V/f <input type="checkbox"/> CL-V/f <input type="checkbox"/> OLV <input checked="" type="checkbox"/> CLV <input type="checkbox"/> AOLV <input type="checkbox"/> OLV/PM <input type="checkbox"/> AOLV/PM <input type="checkbox"/> CLV/PM <input type="checkbox"/> EZOLV Shows the Feed Forward control output. Unit: 0.01%	10 V = Motor secondary rated current (-10 V to +10 V)
U6-27 (006D) Expert	FeedFwd Estimate Spd	<input type="checkbox"/> V/f <input type="checkbox"/> CL-V/f <input type="checkbox"/> OLV <input checked="" type="checkbox"/> CLV <input type="checkbox"/> AOLV <input type="checkbox"/> OLV/PM <input type="checkbox"/> AOLV/PM <input type="checkbox"/> CLV/PM <input type="checkbox"/> EZOLV Shows the feed forward estimated speed. Unit: 0.01%	10 V = Maximum frequency (-10 V to +10 V)
U6-31 (007B)	TorqueDetect Monitor	<input type="checkbox"/> V/f <input type="checkbox"/> CL-V/f <input type="checkbox"/> OLV <input checked="" type="checkbox"/> CLV <input type="checkbox"/> AOLV <input type="checkbox"/> OLV/PM <input type="checkbox"/> AOLV/PM <input type="checkbox"/> CLV/PM <input type="checkbox"/> EZOLV Monitors the torque reference or the output current after applying the filter set to L6-07 [Torque Detection Filter Time]. Unit: 0.1%	10 V:100%
U6-36 (0720) Expert	Comm Errors-Host	<input type="checkbox"/> V/f <input type="checkbox"/> CL-V/f <input type="checkbox"/> OLV <input checked="" type="checkbox"/> CLV <input type="checkbox"/> AOLV <input type="checkbox"/> OLV/PM <input type="checkbox"/> AOLV/PM <input type="checkbox"/> CLV/PM <input type="checkbox"/> EZOLV Shows the number of inter-CPU communication errors. When you de-energize the drive, this value resets to 0.	No signal output available
U6-37 (0721) Expert	Comm Errors-Sensor	<input type="checkbox"/> V/f <input type="checkbox"/> CL-V/f <input type="checkbox"/> OLV <input checked="" type="checkbox"/> CLV <input type="checkbox"/> AOLV <input type="checkbox"/> OLV/PM <input type="checkbox"/> AOLV/PM <input type="checkbox"/> CLV/PM <input type="checkbox"/> EZOLV Shows the number of inter-CPU communication errors. When you de-energize the drive, this value resets to 0.	No signal output available
U6-48 (072E) Expert	ASIC Comm Errors	<input type="checkbox"/> V/f <input type="checkbox"/> CL-V/f <input type="checkbox"/> OLV <input checked="" type="checkbox"/> CLV <input type="checkbox"/> AOLV <input type="checkbox"/> OLV/PM <input type="checkbox"/> AOLV/PM <input type="checkbox"/> CLV/PM <input type="checkbox"/> EZOLV Shows the number of inter-ASIC communication errors detected by the ASIC. When you de-energize the drive, this value resets to 0.	No signal output available
U6-57 (07C4)	PolePolarityDeterVal	<input type="checkbox"/> V/f <input type="checkbox"/> CL-V/f <input type="checkbox"/> OLV <input checked="" type="checkbox"/> CLV <input type="checkbox"/> AOLV <input type="checkbox"/> OLV/PM <input type="checkbox"/> AOLV/PM <input type="checkbox"/> CLV/PM <input type="checkbox"/> EZOLV Shows the change from the integrated current when the drive finds the polarity. Unit: 1 Note: If the change from the integrated current is less than 819, increase n8-84 [Polarity Detection Current]. U6-57 = 8192 is equivalent to the motor rated current.	No signal output available
U6-80 (07B0)	Option IP Address 1	<input type="checkbox"/> V/f <input type="checkbox"/> CL-V/f <input type="checkbox"/> OLV <input checked="" type="checkbox"/> CLV <input type="checkbox"/> AOLV <input type="checkbox"/> OLV/PM <input type="checkbox"/> AOLV/PM <input type="checkbox"/> CLV/PM <input type="checkbox"/> EZOLV Shows the currently available local IP Address (1st octet).	No signal output available
U6-81 (07B1)	Option IP Address 2	<input type="checkbox"/> V/f <input type="checkbox"/> CL-V/f <input type="checkbox"/> OLV <input checked="" type="checkbox"/> CLV <input type="checkbox"/> AOLV <input type="checkbox"/> OLV/PM <input type="checkbox"/> AOLV/PM <input type="checkbox"/> CLV/PM <input type="checkbox"/> EZOLV Shows the currently available local IP Address (2nd octet).	No signal output available
U6-82 (07B2)	Option IP Address 3	<input type="checkbox"/> V/f <input type="checkbox"/> CL-V/f <input type="checkbox"/> OLV <input checked="" type="checkbox"/> CLV <input type="checkbox"/> AOLV <input type="checkbox"/> OLV/PM <input type="checkbox"/> AOLV/PM <input type="checkbox"/> CLV/PM <input type="checkbox"/> EZOLV Shows the currently available local IP Address (3rd octet).	No signal output available
U6-83 (07B3)	Option IP Address 4	<input type="checkbox"/> V/f <input type="checkbox"/> CL-V/f <input type="checkbox"/> OLV <input checked="" type="checkbox"/> CLV <input type="checkbox"/> AOLV <input type="checkbox"/> OLV/PM <input type="checkbox"/> AOLV/PM <input type="checkbox"/> CLV/PM <input type="checkbox"/> EZOLV Shows the currently available local IP Address (4th octet).	No signal output available
U6-84 (07B4)	Online Subnet 1	<input type="checkbox"/> V/f <input type="checkbox"/> CL-V/f <input type="checkbox"/> OLV <input checked="" type="checkbox"/> CLV <input type="checkbox"/> AOLV <input type="checkbox"/> OLV/PM <input type="checkbox"/> AOLV/PM <input type="checkbox"/> CLV/PM <input type="checkbox"/> EZOLV Shows the currently available subnet mask (1st octet).	No signal output available
U6-85 (07B5)	Online Subnet 2	<input type="checkbox"/> V/f <input type="checkbox"/> CL-V/f <input type="checkbox"/> OLV <input checked="" type="checkbox"/> CLV <input type="checkbox"/> AOLV <input type="checkbox"/> OLV/PM <input type="checkbox"/> AOLV/PM <input type="checkbox"/> CLV/PM <input type="checkbox"/> EZOLV Shows the currently available subnet mask (2nd octet).	No signal output available
U6-86 (07B6)	Online Subnet 3	<input type="checkbox"/> V/f <input type="checkbox"/> CL-V/f <input type="checkbox"/> OLV <input checked="" type="checkbox"/> CLV <input type="checkbox"/> AOLV <input type="checkbox"/> OLV/PM <input type="checkbox"/> AOLV/PM <input type="checkbox"/> CLV/PM <input type="checkbox"/> EZOLV Shows the currently available subnet mask (3rd octet).	No signal output available
U6-87 (07B7)	Online Subnet 4	<input type="checkbox"/> V/f <input type="checkbox"/> CL-V/f <input type="checkbox"/> OLV <input checked="" type="checkbox"/> CLV <input type="checkbox"/> AOLV <input type="checkbox"/> OLV/PM <input type="checkbox"/> AOLV/PM <input type="checkbox"/> CLV/PM <input type="checkbox"/> EZOLV Shows the currently available subnet mask (4th octet).	No signal output available
U6-88 (07B8)	Online Gateway 1	<input type="checkbox"/> V/f <input type="checkbox"/> CL-V/f <input type="checkbox"/> OLV <input checked="" type="checkbox"/> CLV <input type="checkbox"/> AOLV <input type="checkbox"/> OLV/PM <input type="checkbox"/> AOLV/PM <input type="checkbox"/> CLV/PM <input type="checkbox"/> EZOLV Shows the currently available Gateway address (1st octet).	No signal output available
U6-89 (07B9)	Online Gateway 2	<input type="checkbox"/> V/f <input type="checkbox"/> CL-V/f <input type="checkbox"/> OLV <input checked="" type="checkbox"/> CLV <input type="checkbox"/> AOLV <input type="checkbox"/> OLV/PM <input type="checkbox"/> AOLV/PM <input type="checkbox"/> CLV/PM <input type="checkbox"/> EZOLV Shows the currently available Gateway address (2nd octet).	No signal output available
U6-90 (07F0)	Online Gateway 3	<input type="checkbox"/> V/f <input type="checkbox"/> CL-V/f <input type="checkbox"/> OLV <input checked="" type="checkbox"/> CLV <input type="checkbox"/> AOLV <input type="checkbox"/> OLV/PM <input type="checkbox"/> AOLV/PM <input type="checkbox"/> CLV/PM <input type="checkbox"/> EZOLV Shows the currently available Gateway address (3rd octet).	No signal output available
U6-91 (07F1)	Online Gateway 4	<input type="checkbox"/> V/f <input type="checkbox"/> CL-V/f <input type="checkbox"/> OLV <input checked="" type="checkbox"/> CLV <input type="checkbox"/> AOLV <input type="checkbox"/> OLV/PM <input type="checkbox"/> AOLV/PM <input type="checkbox"/> CLV/PM <input type="checkbox"/> EZOLV Shows the currently available Gateway address (4th octet).	No signal output available
U6-92 (07F2)	Online Speed	<input type="checkbox"/> V/f <input type="checkbox"/> CL-V/f <input type="checkbox"/> OLV <input checked="" type="checkbox"/> CLV <input type="checkbox"/> AOLV <input type="checkbox"/> OLV/PM <input type="checkbox"/> AOLV/PM <input type="checkbox"/> CLV/PM <input type="checkbox"/> EZOLV Shows the currently available communications speed. 10: 10 Mbps 100: 100 Mbps	No signal output available
U6-93 (07F3)	Online Duplex	<input type="checkbox"/> V/f <input type="checkbox"/> CL-V/f <input type="checkbox"/> OLV <input checked="" type="checkbox"/> CLV <input type="checkbox"/> AOLV <input type="checkbox"/> OLV/PM <input type="checkbox"/> AOLV/PM <input type="checkbox"/> CLV/PM <input type="checkbox"/> EZOLV Shows the currently available Duplex setting.	No signal output available

No. (Hex.)	Name	Description	MFAO Signal Level
U6-98 (07F8)	First Fault	V/f CL-V/f OLV CLV AOLV OLV/PM AOLV/PM CLV/PM EZOLV Shows the contents of the most recent communication options fault (DeviceNet, Modbus TCP/IP, EtherNet/IP).	No signal output available
U6-99 (07F9)	Current Fault	V/f CL-V/f OLV CLV AOLV OLV/PM AOLV/PM CLV/PM EZOLV Shows the contents of current fault from communication options (DeviceNet, Modbus TCP/IP, EtherNet/IP).	No signal output available

◆ U8: DriveWorksEZ Monitors

No. (Hex.)	Name	Description	MFAO Signal Level
U8-01 (1950)	DWEZ Monitor 1	V/f CL-V/f OLV CLV AOLV OLV/PM AOLV/PM CLV/PM EZOLV Shows DWEZ Monitor 1. (Display range: 0.00% to 999.99%) Unit: 0.01%	10 V = 100%
U8-02 (1951)	DWEZ Monitor 2	V/f CL-V/f OLV CLV AOLV OLV/PM AOLV/PM CLV/PM EZOLV Shows DWEZ Monitor 2. (Display range: 0.00% to 999.99%) Unit: 0.01%	10 V = 100%
U8-03 (1952)	DWEZ Monitor 3	V/f CL-V/f OLV CLV AOLV OLV/PM AOLV/PM CLV/PM EZOLV Shows DWEZ Monitor 3. (Display range: 0.00% to 999.99%) Unit: 0.01%	10 V = 100%
U8-04 (1953)	DWEZ Monitor 4	V/f CL-V/f OLV CLV AOLV OLV/PM AOLV/PM CLV/PM EZOLV Shows DWEZ Monitor 4. (Display range: 0.00% to 999.99%) Unit: 0.01%	10 V = 100%
U8-05 (1954)	DWEZ Monitor 5	V/f CL-V/f OLV CLV AOLV OLV/PM AOLV/PM CLV/PM EZOLV Shows DWEZ Monitor 5. (Display range: 0.00% to 999.99%) Unit: 0.01%	10 V = 100%
U8-06 (1955)	DWEZ Monitor 6	V/f CL-V/f OLV CLV AOLV OLV/PM AOLV/PM CLV/PM EZOLV Shows DWEZ Monitor 6. (Display range: 0.00% to 999.99%) Unit: 0.01%	10 V = 100%
U8-07 (1956)	DWEZ Monitor 7	V/f CL-V/f OLV CLV AOLV OLV/PM AOLV/PM CLV/PM EZOLV Shows DWEZ Monitor 7. (Display range: -999.9% to +999.99%) Unit: 0.01%	10 V = 100%
U8-08 (1957)	DWEZ Monitor 8	V/f CL-V/f OLV CLV AOLV OLV/PM AOLV/PM CLV/PM EZOLV Shows DWEZ Monitor 8. (Display range: -999.9% to +999.99%) Unit: 0.01%	10 V = 100%
U8-09 (1958)	DWEZ Monitor 9	V/f CL-V/f OLV CLV AOLV OLV/PM AOLV/PM CLV/PM EZOLV Shows DWEZ Monitor 9. (Display range: -999.9% to +999.99%) Unit: 0.01%	10 V = 100%
U8-10 (1959)	DWEZ Monitor 10	V/f CL-V/f OLV CLV AOLV OLV/PM AOLV/PM CLV/PM EZOLV Shows DWEZ Monitor 10.	No signal output available
U8-11 (195A)	DWEZ Version 1	V/f CL-V/f OLV CLV AOLV OLV/PM AOLV/PM CLV/PM EZOLV Shows the Upper three digits of the user ID. When you click the setting button on the title bar of the PC tool to open the setting screen, you can confirm the user ID with the primary user ID display.	No signal output available
U8-12 (195B)	DWEZ Version 2	V/f CL-V/f OLV CLV AOLV OLV/PM AOLV/PM CLV/PM EZOLV Shows the lower five digits of the user ID. When you click the setting button on the title bar of the PC tool to open the setting screen, you can confirm the user ID with the primary user ID display.	No signal output available
U8-13 (195C)	DWEZ Version 3	V/f CL-V/f OLV CLV AOLV OLV/PM AOLV/PM CLV/PM EZOLV Shows the software ID.	No signal output available
U8-18 (1961)	DWEZ Platform Ver	V/f CL-V/f OLV CLV AOLV OLV/PM AOLV/PM CLV/PM EZOLV Shows the DriveWorksEZ platform version.	No signal output available
U8-21 (1964)	DWEZ Monitor 21	V/f CL-V/f OLV CLV AOLV OLV/PM AOLV/PM CLV/PM EZOLV Shows DWEZ Monitor 21. (Display range: -999.9% to +999.99%) Unit: 0.01%	10 V = 100%
U8-22 (1965)	DWEZ Monitor 22	V/f CL-V/f OLV CLV AOLV OLV/PM AOLV/PM CLV/PM EZOLV Shows DWEZ Monitor 22. Unit: The number of decimal points shown is set with Q2-21.	10 V = 100%
U8-23 (1966)	DWEZ Monitor 23	V/f CL-V/f OLV CLV AOLV OLV/PM AOLV/PM CLV/PM EZOLV Shows DWEZ Monitor 23. Unit: The number of decimal points shown is set with Q2-22.	10 V = 100%

No. (Hex.)	Name	Description	MFAO Signal Level
U8-24 (1967)	DWEZ Monitor 24	V/f CL-V/f OLV CLV AOLV OLV/PM AOLV/PM CLV/PM EZOLV Shows DWEZ Monitor 24. Unit: The number of decimal points shown is set with Q2-23.	10 V = 100%
U8-25 (1968)	DWEZ Monitor 25	V/f CL-V/f OLV CLV AOLV OLV/PM AOLV/PM CLV/PM EZOLV Shows DWEZ Monitor 25. Unit: The number of decimal points shown is set with Q2-24.	10 V = 100%
U8-31 (196E)	DWEZ Monitor 31	V/f CL-V/f OLV CLV AOLV OLV/PM AOLV/PM CLV/PM EZOLV Shows DWEZ Monitor 31. (Display range: 0.00% to 999.99%) Unit: 0.01%	10 V = 100%
U8-32 (196F)	DWEZ Monitor 32	V/f CL-V/f OLV CLV AOLV OLV/PM AOLV/PM CLV/PM EZOLV Shows DWEZ Monitor 32. (Display range: 0.00% to 999.99%) Unit: 0.01%	10 V = 100%
U8-33 (1970)	DWEZ Monitor 33	V/f CL-V/f OLV CLV AOLV OLV/PM AOLV/PM CLV/PM EZOLV Shows DWEZ Monitor 33. (Display range: 0.00% to 999.99%) Unit: 0.01%	10 V = 100%
U8-34 (1971)	DWEZ Monitor 34	V/f CL-V/f OLV CLV AOLV OLV/PM AOLV/PM CLV/PM EZOLV Shows DWEZ Monitor 34. (Display range: 0.00% to 999.99%) Unit: 0.01%	10 V = 100%
U8-35 (1972)	DWEZ Monitor 35	V/f CL-V/f OLV CLV AOLV OLV/PM AOLV/PM CLV/PM EZOLV Shows DWEZ Monitor 35. (Display range: 0.00% to 999.99%) Unit: 0.01%	10 V = 100%
U8-36 (1973)	DWEZ Monitor 36	V/f CL-V/f OLV CLV AOLV OLV/PM AOLV/PM CLV/PM EZOLV Shows DWEZ Monitor 36. (Display range: 0.00% to 999.99%) Unit: 0.01%	10 V = 100%
U8-37 (1974)	DWEZ Monitor 37	V/f CL-V/f OLV CLV AOLV OLV/PM AOLV/PM CLV/PM EZOLV Shows DWEZ Monitor 37. (Display range: -999.9% to +999.99%) Unit: 0.01%	10 V = 100%
U8-38 (1975)	DWEZ Monitor 38	V/f CL-V/f OLV CLV AOLV OLV/PM AOLV/PM CLV/PM EZOLV Shows DWEZ Monitor 38. (Display range: -999.9% to +999.99%) Unit: 0.01%	10 V = 100%
U8-39 (1976)	DWEZ Monitor 39	V/f CL-V/f OLV CLV AOLV OLV/PM AOLV/PM CLV/PM EZOLV Shows DWEZ Monitor 39. (Display range: -999.9% to +999.99%) Unit: 0.01%	10 V = 100%
U8-40 (1977)	DWEZ Monitor 40	V/f CL-V/f OLV CLV AOLV OLV/PM AOLV/PM CLV/PM EZOLV Shows DWEZ Monitor 40.	No signal output available
U8-51 (1982)	DWEZ Monitor 51	V/f CL-V/f OLV CLV AOLV OLV/PM AOLV/PM CLV/PM EZOLV Shows DWEZ Monitor 51. (Display range: -999.9% to +999.99%) Unit: 0.01%	10 V = 100%
U8-52 (1983)	DWEZ Monitor 52	V/f CL-V/f OLV CLV AOLV OLV/PM AOLV/PM CLV/PM EZOLV Shows DWEZ Monitor 52. Unit: The number of decimal points shown is set with Q2-41.	10 V = 100%
U8-53 (1984)	DWEZ Monitor 53	V/f CL-V/f OLV CLV AOLV OLV/PM AOLV/PM CLV/PM EZOLV Shows DWEZ Monitor 53. Unit: The number of decimal points shown is set with Q2-42.	10 V = 100%
U8-54 (1985)	DWEZ Monitor 54	V/f CL-V/f OLV CLV AOLV OLV/PM AOLV/PM CLV/PM EZOLV Shows DWEZ Monitor 54. Unit: The number of decimal points shown is set with Q2-43.	10 V = 100%
U8-55 (1986)	DWEZ Monitor 55	V/f CL-V/f OLV CLV AOLV OLV/PM AOLV/PM CLV/PM EZOLV Shows DWEZ Monitor 55. Unit: The number of decimal points shown is set with Q2-44.	10 V = 100%
U8-60 (198B)	RemoteIO Status	V/f CL-V/f OLV CLV AOLV OLV/PM AOLV/PM CLV/PM EZOLV Shows the operation status of Remote IO as 1 (ON) and 0 (OFF). If the DriveWorksEZ MEMOBUS master active signal is ON, for example, the monitor shows U8-60 = 00000001. bit 0 : Bit 0: DriveWorksEZ MEMOBUS Master Active bit 1 : Not used (normal value of 0) bit 2 : Not used (normal value of 0) bit 3 : Not used (normal value of 0) bit 4 : Not used (normal value of 0) bit 5 : Not used (normal value of 0) bit 6 : Not used (normal value of 0) bit 7 : Not used (normal value of 0)	No signal output available

No. (Hex.)	Name	Description	MFAO Signal Level
U8-61 (198C)	RemoteDI Monitor 0-7bit	<p>V/f CL-V/f OLV CLV AOLV OLV/PM AOLV/PM CLV/PM EZOLV</p> <p>Shows the operation status of Remote DI1 to DI8 as 1 (ON) and 0 (OFF). If Remote DI1 and DI2 are ON, for example, the monitor shows <i>U8-61 = 00000011</i>.</p> <p>bit 0 : Remote DI1 bit 1 : Remote DI2 bit 2 : Remote DI3 bit 3 : Remote DI4 bit 4 : Remote DI5 bit 5 : Remote DI6 bit 6 : Remote DI7 bit 7 : Remote DI8</p>	No signal output available
U8-62 (198D)	RemoteDI Monitor 8-Fbit	<p>V/f CL-V/f OLV CLV AOLV OLV/PM AOLV/PM CLV/PM EZOLV</p> <p>Shows the operation status of Remote DI9 to DI16 as 1 (ON) and 0 (OFF). If Remote DI9 and DI10 are ON, for example, the monitor shows <i>U8-62 = 00000011</i>.</p> <p>bit 0 : Remote DI9 bit 1 : Remote DI10 bit 2 : Remote DI11 bit 3 : Remote DI12 bit 4 : Remote DI13 bit 5 : Remote DI14 bit 6 : Remote DI15 bit 7 : Remote DI16</p>	No signal output available
U8-63 (198E)	RemoteDO Monitor 0-7bit	<p>V/f CL-V/f OLV CLV AOLV OLV/PM AOLV/PM CLV/PM EZOLV</p> <p>Shows the operation status of Remote DO1 to DO8 as 1 (ON) and 0 (OFF). If Remote DO1 and DO2 are ON, for example, the monitor shows <i>U8-63 = 00000011</i>.</p> <p>bit 0 : Remote DO1 bit 1 : Remote DO2 bit 2 : Remote DO3 bit 3 : Remote DO4 bit 4 : Remote DO5 bit 5 : Remote DO6 bit 6 : Remote DO7 bit 7 : Remote DO8</p>	No signal output available
U8-64 (198F)	RemoteDO Monitor 8-Fbit	<p>V/f CL-V/f OLV CLV AOLV OLV/PM AOLV/PM CLV/PM EZOLV</p> <p>Shows the operation status of Remote DO9 to DO16 as 1 (ON) and 0 (OFF). If Remote DO9 and DO10 are ON, for example, the monitor shows <i>U8-64 = 00000011</i>.</p> <p>bit 0 : Remote DO9 bit 1 : Remote DO10 bit 2 : Remote DO11 bit 3 : Remote DO12 bit 4 : Remote DO13 bit 5 : Remote DO14 bit 6 : Remote DO15 bit 7 : Remote DO16</p>	No signal output available

◆ Ud: Control Monitors

No. (Hex.)	Name	Description	MFAO Signal Level
Ud-01 (1BF2)	ASR Integral Output	<p>V/f CL-V/f OLV CLV AOLV OLV/PM AOLV/PM CLV/PM EZOLV</p> <p>Shows the ASR output value of the integrated component as a percentage of the motor rated secondary current. Unit: 0.01%</p>	10 V = Motor secondary rated current (-10 V to +10 V)

11.18 Parameters that Change from the Default Settings with A1-02 [Control Method Selection]

The values for the parameters in these tables depend on the values for *A1-02*. When you change *A1-02*, the default settings will change.

◆ A1-02 = 0 to 4 [Induction Motor Control Methods]

No.	Name	Range	Unit	Control Method (A1-02 Setting)				
				V/f (0)	CL-V/f (1)	OLV (2)	CLV (3)	AOLV (4)
b2-01	DC Injection/ Zero SpeedThreshold	0.0 - 10.0	0.1 Hz	0.5	0.5	0.5	0.5	0.5
b2-04	DC Inject Braking Time at Stop	0.00 - 10.00	0.01 s	0.50	0.50	0.50	0.50	0.50
b3-01	Speed Search at Start Selection	0, 1	1	0	1	0	-	0
b3-02	SpeedSearch Deactivation Current	0 - 200	1%	120	-	100	-	-
b3-08	Speed Estimation ACR P Gain	0.00 - 6.00	0.01	0.50 *1	0.50 *1	0.50 *1	0.50 *1	0.50 *1
b3-09	Speed Estimation ACR I Time	0.0 - 1000.0	0.1 ms	2.0	2.0	2.0	2.0	2.0
b3-14	Bi-directional Speed Search	0, 1	1	0	0	0	-	1
b5-15	PID Sleep Function Start Level	0.0 - 400.0	0.1 Hz	0.0	0.0	0.0	0.0	0.0
b6-01	Dwell Reference at Start	0.0 - 400.0	0.1 Hz	0.0	0.0	0.0	0.0	0.0
b6-03	Dwell Reference at Stop	0.0 - 400.0	0.1 Hz	0.0	0.0	0.0	0.0	0.0
b8-02	Energy Saving Gain	0.0 - 10.0	0.1	-	-	0.7	1.0	1.0
b8-03	Energy Saving Filter Time	0.00 - 10.00	0.01 s	-	-	0.50 *2	0.01 *2	0.01 *2
b8-19	E-Save Search Injection Freq	10 - 300	1 Hz	-	-	-	-	-
C1-11	Accel/Decel Time Switchover Freq	0.0 - 400.0	0.1 Hz	0.0	0.0	0.0	0.0	0.0
C2-01	S-Curve Time @ Start of Accel	0.00 - 10.00	0.01 s	0.20	0.20	0.20	0.20	0.20
C3-01	Slip Compensation Gain	0.0 - 2.5	0.1	0.0	-	1.0	1.0	0.0
C3-02	Slip Compensation Delay Time	0 - 10000	1 ms	2000	-	200	-	-
C4-01	Torque Compensation Gain	0.00 - 2.50	0.01	1.00	1.00	1.00	-	-
C4-02	Torque Compensation Delay Time	0 - 60000	1 ms	200	200	20	-	-
C4-25	High-Speed Voltage Compensation	0, 1	1	0	1	1	1	1
C5-01	ASR Proportional Gain 1	0.00 - 300.00	0.01	-	0.20	-	20.00	10.00
C5-02	ASR Integral Time 1	0.000 - 60.000	0.001 s	-	0.200	-	0.500	0.500
C5-03	ASR Proportional Gain 2	0.00 - 300.00	0.01	-	0.02	-	20.00	20.00

11.18 Parameters that Change from the Default Settings with A1-02 [Control Method Selection]

No.	Name	Range	Unit	Control Method (A1-02 Setting)				
				V/f (0)	CL-V/f (1)	OLV (2)	CLV (3)	AOLV (4)
C5-04	ASR Integral Time 2	0.000 - 60.000	0.001 s	-	0.050	-	0.500	0.500
C5-06	ASR Delay Time	0.000 - 0.500	0.001 s	-	-	-	0.004	0.004
C5-07	ASR Gain Switchover Frequency	0.0 - 400.0	0.1 Hz	-	-	-	0.0	0.0
C6-02	Carrier Frequency Selection	1 - F	1	1 *3	1 *3	1 *3	1	1
d3-01	Jump Frequency 1	0.0 - 400.0	0.1 Hz	0.0	0.0	0.0	0.0	0.0
d3-02	Jump Frequency 2	0.0 - 400.0	0.1 Hz	0.0	0.0	0.0	0.0	0.0
d3-03	Jump Frequency 3	0.0 - 400.0	0.1 Hz	0.0	0.0	0.0	0.0	0.0
d3-04	Jump Frequency Width	0.0 - 20.0	0.1 Hz	1.0	1.0	1.0	1.0	1.0
d5-02	Torque Reference Delay Time	0 - 1000	1 ms	-	-	-	0	0
E1-04	Maximum Output Frequency	40.0 - 590.0 *3 *4	0.1 Hz	60.0 *5	60.0 *5	60.0	60.0	60.0
E1-05	Maximum Output Voltage	0.0 - 255.0 *6	0.1 V	200.0 *5	200.0 *5	200.0	200.0	200.0
E1-06	Base Frequency	0.0 - 590.0 *4	0.1 Hz	60.0 *5	60.0 *5	60.0	60.0	60.0
E1-07	Mid Point A Frequency	0.0 - 590.0 *7	0.1 Hz	3.0 *5	3.0 *5	3.0	-	0.0
E1-08	Mid Point A Voltage	0.0 - 255.0 *6	0.1 V	15.0 *5	15.0 *5	11.0	-	0.0
E1-09	Minimum Output Frequency	0.0 - 590.0 *4	0.1 Hz	1.5 *5	1.5 *5	0.5	0.0	0.0
E1-10	Minimum Output Voltage	0.0 - 255.0 *6	0.1 V	9.0 *5	9.0 *5	2.0	-	0.0
E1-11	Mid Point B Frequency	0.0 - 400.0	0.1 Hz	0.0	0.0	0.0	0.0	0.0
E1-12	Mid Point A Voltage	0.0 - 255.0 *6	0.1 V	0.0	0.0	0.0	0.0	0.0
E1-13	Base Voltage	0.0 - 255.0 *6	0.1 V	0.0	0.0	0.0	0.0	0.0
F1-01	Encoder 1 Pulse Count (PPR)	0 - 60000	1 ppr	-	600	-	600	600
F1-05	Encoder 1 Rotation Selection	0, 1	1	-	0	-	0	0
F1-09	Overspeed Detection Delay Time	0.0 - 2.0	0.1 s	-	1.0	-	0.0	0.1
L1-01	Motor Overload (oL1) Protection	0 - 6	1	1	1	1	1	1
L2-31	KEB Start Voltage Offset Level	0 - 100 *6	1 V	0	0	0	0	0
L3-05	Stall Prevention during RUN	0 - 3	1	1	1	-	-	-
L3-20	DC Bus Voltage Adjustment Gain	0.00 - 5.00	0.01	1.00	1.00	0.30	0.30	0.30
L3-21	OVSsuppression Accel/Decel P Gain	0.10 - 10.00	0.01	1.00	1.00	1.00	1.00	1.00
L3-36	Current Suppression Gain@Accel	0.0 - 100.0	0.1	10.0	10.0	20.0	-	-
L4-01	Speed Agree Detection Level	0.0 - 590.0 *4	0.1	0.0 Hz	0.0 Hz	0.0 Hz	0.0 Hz	0.0 Hz
L4-02	Speed Agree Detection Width	0.0 - 20.0	0.1	2.0 Hz	2.0 Hz	2.0 Hz	2.0 Hz	2.0 Hz

11.18 Parameters that Change from the Default Settings with A1-02 [Control Method Selection]

No.	Name	Range	Unit	Control Method (A1-02 Setting)				
				V/f (0)	CL-V/f (1)	OLV (2)	CLV (3)	AOLV (4)
L4-03	Speed Agree Detection Level (+/-)	-590.0 - +590.0 <i>*4 *8</i>	0.1	0.0 Hz	0.0 Hz	0.0 Hz	0.0 Hz	0.0 Hz
L4-04	Speed Agree Detection Width (+/-)	0.0 - 20.0	0.1	2.0 Hz	2.0 Hz	2.0 Hz	2.0 Hz	2.0 Hz
L8-38	Carrier Frequency Reduction	0 - 2	1	<i>*3</i>	<i>*3</i>	<i>*3</i>	<i>*3</i>	-
L8-40	Carrier Freq Reduction Off-Delay	0.00 - 2.00	0.01 s	0.50	0.50	0.50	0.50	-
L8-90	STPo Detection Level (Low Speed)	0 - 5000	1	-	-	-	-	-
n1-15	PWM Voltage Offset Calibration	0 - 2	1	1	1	1	1	2
n5-04	Speed Response Frequency	0.00 - 500.00	0.01 Hz	-	-	-	50.00	50.00
n8-35	Initial Pole Detection Method	0 - 2	1	-	-	-	-	-
n8-51	Pull-in Current @ Acceleration	0 - 200	1%	-	-	-	-	-
o1-03	Frequency Display Unit Selection	0 - 3	1	0	0	0	0	0
o1-04	V/f Pattern Display Unit	0, 1	1	-	-	-	0	0

- *1 The default setting changes when the setting for o2-04 [Drive Model Selection] changes.
- *2 Models 2211 to 2415 and 4103 to 4H12 use these default settings when C6-01 = 1 [Normal / Heavy Duty Selection = Normal Duty Rating]. Models 2257 to 2415 and 4140 to 4H12 use these default settings when C6-01 = 0 [Heavy Duty Rating].
- A1-02 = 2 [Open Loop Vector]: 2.00
 - A1-02 = 3, 4 [Closed Loop Vector, Advanced Open Loop Vector]: 0.05
- *3 The default setting changes when C6-01 [Normal / Heavy Duty Selection] changes.
- *4 The maximum value changes when A1-02 changes:
- When A1-02 = 0, 2 [V/f Control, Open Loop Vector], the maximum value is 590.0 Hz.
 - When A1-02 = 1, 3 [V/f Control with Encoder, Closed Loop Vector], the maximum value is 400.0 Hz.
 - When A1-02 = 4 [Advanced Open Loop Vector], the maximum value is 120.0 Hz.
- *5 The default setting changes when the drive model and E1-03 [V/f Pattern Selection] change.
- *6 This is the value for 200 V class drives. Double the value for 400 V class drives.
- *7 The maximum value changes when A1-02 changes:
- When A1-02 = 0, 2 [V/f Control, Open Loop Vector], the maximum value is 590.0 Hz.
 - When A1-02 = 1 [V/f Control with Encoder], the maximum value is 400.0 Hz.
 - When A1-02 = 4 [Advanced Open Loop Vector], the maximum value is 120.0 Hz.
- *8 The minimum value changes when A1-02 changes:
- When A1-02 = 0, 2 [V/f Control, Open Loop Vector], the minimum value is -590.0 Hz.
 - When A1-02 = 1, 3 [V/f Control with Encoder, Closed Loop Vector], the minimum value is -400.0 Hz.
 - When A1-02 = 4 [Advanced Open Loop Vector], the minimum value is -120.0 Hz.

◆ A1-02 = 5 to 8 [Control Method for PM Motors and EZ Vector Control]

No.	Name	Range	Unit	Control Method (A1-02 Setting)			
				OLV/PM (5)	AOLV/PM (6)	CLV/PM (7)	EZOLV (8)
b2-01	DC Injection/Zero SpeedThreshold	0.0 - 10.0	0.1	0.5 Hz	1.0%	0.5%	0.5 Hz
b2-04	DC Inject Braking Time at Stop	0.00 - 10.00	0.01 s	0.00	0.00	0.00	0.00
b3-01	Speed Search at Start Selection	0, 1	1	0	0	-	0
b3-02	SpeedSearch Deactivation Current	0 - 200	1%	-	-	-	-

11.18 Parameters that Change from the Default Settings with A1-02 [Control Method Selection]

No.	Name	Range	Unit	Control Method (A1-02 Setting)			
				OLV/PM (5)	AOLV/PM (6)	CLV/PM (7)	EZOLV (8)
b3-08	Speed Estimation ACR P Gain	0.00 - 6.00	0.01	0.30	0.30	-	0.60 *1
b3-09	Speed Estimation ACR I Time	0.0 - 1000.0	0.1 ms	4.0	4.0	-	10.0
b3-14	Bi-directional Speed Search	0, 1	1	-	-	-	0
b5-15	PID Sleep Function Start Level	0.0 - 400.0 *3	0.1	0.0 Hz	0.0%	0.0%	0.0 Hz
b6-01	Dwell Reference at Start	0.0 - 400.0 *3	0.1	0.0 Hz	0.0%	0.0%	0.0 Hz
b6-03	Dwell Reference at Stop	0.0 - 400.0 *3	0.1	0.0 Hz	0.0%	0.0%	0.0 Hz
b8-02	Energy Saving Gain	0.0 - 10.0	0.1	-	-	-	-
b8-03	Energy Saving Filter Time	0.00 - 10.00	0.01 s	-	-	-	-
b8-19	E-Save Search Injection Freq	10 - 300	1 Hz	-	100	100	20
C1-11	Accel/Decel Time Switchover Freq	0.0 - 400.0 *3	0.1	0.0 Hz	0.0%	0.0%	0.0 Hz
C2-01	S-Curve Time @ Start of Accel	0.00 - 10.00	0.01 s	1.00	0.20	0.20	1.00
C3-01	Slip Compensation Gain	0.0 - 2.5	0.1	-	-	-	0.0
C3-02	Slip Compensation Delay Time	0 - 10000	1 ms	-	-	-	200
C4-01	Torque Compensation Gain	0.00 - 2.50	0.01	0.00	-	-	0.00
C4-02	Torque Compensation Delay Time	0 - 60000	1 ms	100	-	-	200
C4-25	High-Speed Voltage Compensation	0, 1	1	1	1	-	1
C5-01	ASR Proportional Gain 1	0.00 - 300.00	0.01	-	10.00	20.00	10.00
C5-02	ASR Integral Time 1	0.000 - 60.000	0.001 s	-	0.500	0.500	0.500
C5-03	ASR Proportional Gain 2	0.00 - 300.00	0.01	-	10.00	20.00	10.00
C5-04	ASR Integral Time 2	0.000 - 60.000	0.001 s	-	0.500	0.500	0.500
C5-06	ASR Delay Time	0.000 - 0.500	0.001 s	-	0.016	0.004	0.004
C5-07	ASR Gain Switchover Frequency	0.0 - 400.0 *3	0.1	-	0.0%	0.0%	0.0 Hz
C6-02	Carrier Frequency Selection	1 - F	1	2	2	2	2
d3-01	Jump Frequency 1	0.0 - 400.0 *3	0.1	0.0 Hz	0.0%	0.0%	0.0 Hz
d3-02	Jump Frequency 2	0.0 - 400.0 *3	0.1	0.0 Hz	0.0%	0.0%	0.0 Hz
d3-03	Jump Frequency 3	0.0 - 400.0 *3	0.1	0.0 Hz	0.0%	0.0%	0.0 Hz
d3-04	Jump Frequency Width	0.0 - 20.0 *4	0.1	1.0 Hz	1.0%	1.0%	1.0 Hz
d5-02	Torque Reference Delay Time	0 - 1000	1 ms	-	0	0	-
E1-04	Maximum Output Frequency	40.0 - 590.0 *5 *6	0.1 Hz	Determined by E5-01	Determined by E5-01	Determined by E5-01	-
E1-05	Maximum Output Voltage	0.0 - 255.0 *7	0.1 V	Determined by E5-01	Determined by E5-01	Determined by E5-01	-
E1-06	Base Frequency	0.0 - 590.0 *6	0.1 Hz	Determined by E5-01	Determined by E5-01	Determined by E5-01	-
E1-07	Mid Point A Frequency	0.0 - 590.0	0.1 Hz	-	-	-	-
E1-08	Mid Point A Voltage	0.0 - 255.0 *7	0.1 V	-	-	-	-
E1-09	Minimum Output Frequency	0.0 - 590.0 *6	0.1 Hz	Determined by E5-01	Determined by E5-01	Determined by E5-01	-
E1-10	Minimum Output Voltage	0.0 - 255.0 *7	0.1 V	-	-	-	-

11.18 Parameters that Change from the Default Settings with A1-02 [Control Method Selection]

No.	Name	Range	Unit	Control Method (A1-02 Setting)			
				OLV/PM (5)	AOLV/PM (6)	CLV/PM (7)	EZOLV (8)
E1-11	Mid Point B Frequency	0.0 - 590.0 *6	0.1 Hz	-	-	-	-
E1-12	Mid Point A Voltage	0.0 - 255.0 *7	0.1 V	-	-	-	-
E1-13	Base Voltage	0.0 - 255.0 *7	0.1 V	-	-	-	-
F1-01	Encoder 1 Pulse Count (PPR)	0 - 60000	1 ppr	-	-	1024	-
F1-05	Encoder 1 Rotation Selection	0, 1	1	-	-	1	-
F1-09	Overspeed Detection Delay Time	0.0 - 2.0	0.1 s	-	0.0	0.0	0.0
L1-01	Motor Overload (oL1) Protection	0 - 6	1	4	4	5	1 *8
L2-31	KEB Start Voltage Offset Level	0 - 100 *7	1 V	50	50	50	50
L3-05	Stall Prevention during RUN	0 - 3	1	1	-	-	3
L3-20	DC Bus Voltage Adjustment Gain	0.00 - 5.00	0.01	0.65	0.65	0.65	0.65
L3-21	OV/Suppression Accel/Decel P Gain	0.10 - 10.00	0.01	1.00	1.00	1.00	1.00
L3-36	Current Suppression Gain@Accel	0.0 - 100.0	0.1	-	-	-	-
L4-01	Speed Agree Detection Level	0.0 - 590.0 *10	0.1	0.0 Hz	0.0%	0.0%	0.0 Hz
L4-02	Speed Agree Detection Width	0.0 - 20.0 *4	0.1	2.0 Hz	4.0%	4.0%	2.0 Hz
L4-03	Speed Agree Detection Level(+/-)	-590.0 - +590.0 *10 *11	0.1	0.0 Hz	0.0%	0.0%	0.0 Hz
L4-04	Speed Agree Detection Width(+/-)	0.0 - 20.0 *4	0.1	2.0 Hz	4.0%	4.0%	2.0 Hz
L8-38	Carrier Frequency Reduction	0 - 2	1	0	-	0	0
L8-40	Carrier Freq Reduction Off-Delay	0.00 - 2.00	0.01 s	0.00	-	0.00	0.00
L8-90	STPo Detection Level (Low Speed)	0 - 5000	1	0	80	-	0
n1-15	PWM Voltage Offset Calibration	0 - 2	1	1	1	1	1
n5-04	Speed Response Frequency	0.00 - 500.00	0.01 Hz	-	20.00	50.00	-
n8-35	Initial Pole Detection Method	0 - 2	1	0	1	1	-
n8-51	Pull-in Current @ Acceleration	0 - 200	1%	50%	-	-	80%
o1-03	Frequency Display Unit Selection	0 - 3	1	0	1	1	0 *9
o1-04	V/f Pattern Display Unit	0, 1	1	-	1	1	0 *9

*1 The default setting is different for different models.

- 2138 - 2415, 4089 - 4H12: 0.30

*2 The default setting changes when the setting for o2-04 [Drive Model Selection] changes.

*3 The setting range is 0.0 to 100.0 when A1-02 = 6 or 7 [PM Advanced Open Loop Vector or PM Closed Loop Vector].

*4 The setting range is 0.0 to 40.0 when A1-02 = 6 or 7 [PM Advanced Open Loop Vector or PM Closed Loop Vector].

*5 The default setting changes when C6-01 [Normal / Heavy Duty Selection] changes.

*6 The maximum value changes when A1-02 changes:

- When A1-02 = 5 [PM Open Loop Vector], the maximum value is 590.0 Hz. The maximum value of the setting range changes when E5-01 [PM Motor Code Selection] changes. When E5-01 = FFFF [PM Motor Code Selection = FFFF], the maximum value is 590.0 Hz.
- When A1-02 = 6 or 7 [PM Advanced Open Loop Vector or PM Closed Loop Vector], the maximum value is 400.0 Hz. The maximum value of the setting range changes when E5-01 changes. When E5-01 = FFFF, the maximum value is 400.0 Hz.

*7 This is the value for 200 V class drives. Double the value for 400 V class drives.

11.18 Parameters that Change from the Default Settings with A1-02 [Control Method Selection]

- *8 The default setting changes when *E9-01 [Motor Type Selection]* changes.
 - *E9-01 = 0 [Induction (IM)]*: 1
 - *E9-01 = 1, 2 [Permanent Magnet (PM), Synchronous Reluctance (SynRM)]*: 4
- *9 The default setting changes when *E9-01 [Motor Type Selection]* changes.
 - *E9-01 = 0 [Induction (IM)]*: 0
 - *E9-01 = 1, 2 [Permanent Magnet (PM), Synchronous Reluctance (SynRM)]*: 1
- *10 The maximum value changes when *A1-02* changes:
 - When *A1-02 = 5 [PM Open Loop Vector]*, the maximum value is 590.0 Hz.
 - When *A1-02 = 6 or 7 [PM Advanced Open Loop Vector or PM Closed Loop Vector]*, the maximum value is 100.0%.
 - When *A1-02 = 8 [EZ Vector Control]*, the maximum value is 120.0 Hz.
- *11 The minimum value changes when *A1-02* changes:
 - When *A1-02 = 5 [PM Open Loop Vector]*, the minimum value is -590.0 Hz.
 - When *A1-02 = 6 or 7 [PM Advanced Open Loop Vector or PM Closed Loop Vector]*, the minimum value is -100.0%.
 - When *A1-02 = 8 [EZ Vector Control]*, the minimum value is -120.0 Hz.

11.19 Parameters that Change from the Default Settings with E3-01 [Motor 2 Control Mode Selection]

The values for the parameters in these tables depend on the values for parameter *E3-01*. When you change the setting for *E3-01*, the default settings will change.

No.	Name	Range	Unit	Motor 2 Control Method (setting value of E3-01)			
				V/f (0)	CL-V/f (1)	OLV (2)	CLV (3)
C3-21	Motor 2 Slip Compensation Gain	0.0 - 2.50	0.1	0.0	-	1.0	1.0
C3-22	Motor 2 Slip Comp Delay Time	0 - 10000	1 ms	2000	-	200	-
C5-21	Motor 2 ASR Proportional Gain 1 (P)	0.00 - 300.00	0.01	-	0.20	-	20.00
C5-22	Motor 2 ASR Integral Time 1 (I)	0.000 - 10.000	0.001 s	-	0.200	-	0.500
C5-23	Motor 2 ASR Proportional Gain 2 (P)	0.00 - 300.00	0.01	-	0.02	-	20.00
C5-24	Motor 2 ASR Integral Time 2 (I)	0.000 - 10.000	0.001 s	-	0.050	-	0.500
C5-26	Motor 2 ASR Delay Time	0.000 - 0.500	0.001 s	-	-	-	0.004
E3-04	Motor 2 Maximum Output Frequency	40.0 - 590.0	0.1 Hz	60.0	60.0	60.0	60.0
E3-05	Motor 2 Maximum Output Voltage	0.0 - 255.0 *1	0.1 V	200.0	200.0	200.0	200.0
E3-06	Motor 2 Base Frequency	0.0 - 590.0	0.1 Hz	60.0	60.0	60.0	60.0
E3-07	Motor 2 Mid Point A Frequency	0.0 - 590.0	0.1 Hz	3.0	3.0	3.0	-
E3-08	Motor 2 Mid Point A Voltage	0.0 - 255.0 *1	0.1 V	15.0	15.0	11.0	-
E3-09	Motor 2 Minimum Output Frequency	0.0 - 590.0	0.1 Hz	1.5	1.5	0.5	0.0
E3-10	Motor 2 Minimum Output Voltage	0.0 - 255.0 *1	0.1 V	9.0	9.0	2.0	-
E3-11	Motor 2 Mid Point B Frequency	0.0 - 590.0	Determined by o1-04	0.0	0.0	0.0	0.0
E3-12	Motor 2 Mid Point B Voltage	0.0 - 255.0 *1	0.1 V	0.0	0.0	0.0	0.0
E3-13	Motor 2 Base Voltage	0.0 - 255.0 *1	0.1 V	0.0	0.0	0.0	0.0

*1 This is the value for 200 V class drives. Double the value for 400 V class drives.

11.20 Parameters Changed by E1-03 [V/f Pattern Selection]

The values for parameters *A1-02* [Control Method Selection] and *E1-03* [V/f Pattern Selection] change the default settings for the parameters in these tables:

Table 11.1 Parameters Changed by E1-03 (2004 - 2021 and 4002 - 4012)

No.	E1-03	E1-04	E1-05 ^{*1}	E1-06	E1-07	E1-08 ^{*1}	E1-09	E1-10 ^{*1}
Unit	-	Hz	V	Hz	Hz	V	Hz	V
Setting Value	0	50.0	200.0	50.0	2.5	15.0	1.3	9.0
	1	60.0	200.0	60.0	3.0	15.0	1.5	9.0
	2	60.0	200.0	50.0	3.0	15.0	1.5	9.0
	3	72.0	200.0	60.0	3.0	15.0	1.5	9.0
	4	50.0	200.0	50.0	25.0	35.0	1.3	8.0
	5	50.0	200.0	50.0	25.0	50.0	1.3	9.0
	6	60.0	200.0	60.0	30.0	35.0	1.5	8.0
	7	60.0	200.0	60.0	30.0	50.0	1.5	9.0
	8	50.0	200.0	50.0	2.5	19.0	1.3	11.0
	9	50.0	200.0	50.0	2.5	24.0	1.3	13.0
	A	60.0	200.0	60.0	3.0	19.0	1.5	11.0
	B	60.0	200.0	60.0	3.0	24.0	1.5	15.0
	C	90.0	200.0	60.0	3.0	15.0	1.5	9.0
	D	120.0	200.0	60.0	3.0	15.0	1.5	9.0
	E	180.0	200.0	60.0	3.0	15.0	1.5	9.0
	F	50.0 ^{*2}	200.0 ^{*2}	50.0 ^{*2}	2.5 ^{*2}	15.0 ^{*2}	1.3 ^{*2}	9.0 ^{*2}
Control Method Selection (A1-02 Setting)	OLV (2)	50.0	200.0	50.0	3.0	14.4	0.5	3.0
	CLV (3)	50.0	200.0	50.0	0.0	0.0	0.0	0.0
	OLV/PM (5)	^{*3}	^{*3}	^{*3}	-	-	^{*3}	-
	AOLV/PM (6)	^{*3}	^{*3}	^{*3}	-	-	^{*3}	-
	CLV/PM (7)	^{*3}	^{*3}	^{*3}	-	-	0.0	-

*1 This is the value for 200 V class drives. Double the value for 400 V class drives.

*2 These values are the default settings for *E1-04* to *E1-10* and *E3-04* to *E3-10* [V/f Pattern for Motor 2]. These settings are the same as the settings for the V/f pattern when *E1-03* = 0 [Const Trq, 60Hz base, 60Hz max].

*3 The default setting varies depending on the setting of *E5-01* [PM Motor Code Selection].

Table 11.2 Parameters Changed by E1-03 (2030 - 2211 and 4018 - 4103)

No.	E1-03	E1-04	E1-05 *1	E1-06	E1-07	E1-08 *1	E1-09	E1-10 *1
Unit	-	Hz	V	Hz	Hz	V	Hz	V
Setting Value	0	50.0	200.0	50.0	2.5	14.0	1.3	7.0
	1	60.0	200.0	60.0	3.0	14.0	1.5	7.0
	2	60.0	200.0	50.0	3.0	14.0	1.5	7.0
	3	72.0	200.0	60.0	3.0	14.0	1.5	7.0
	4	50.0	200.0	50.0	25.0	35.0	1.3	6.0
	5	50.0	200.0	50.0	25.0	50.0	1.3	7.0
	6	60.0	200.0	60.0	30.0	35.0	1.5	6.0
	7	60.0	200.0	60.0	30.0	50.0	1.5	7.0
	8	50.0	200.0	50.0	2.5	18.0	1.3	9.0
	9	50.0	200.0	50.0	2.5	23.0	1.3	11.0
	A	60.0	200.0	60.0	3.0	18.0	1.5	9.0
	B	60.0	200.0	60.0	3.0	23.0	1.5	13.0
	C	90.0	200.0	60.0	3.0	14.0	1.5	7.0
	D	120.0	200.0	60.0	3.0	14.0	1.5	7.0
	E	180.0	200.0	60.0	3.0	14.0	1.5	7.0
	F	50.0 *2	200.0 *2	50.0 *2	2.5 *2	14.0 *2	1.3 *2	7.0 *2
Control Method Selection (A1-02 Setting)	OLV (2)	50.0	200.0	50.0	3.0	13.2	0.5	2.4
	CLV (3)	50.0	200.0	50.0	0.0	0.0	0.0	0.0
	OLV/PM (5)	*3	*3	*3	-	-	*3	-
	AOLV/PM (6)	*3	*3	*3	-	-	*3	-
	CLV/PM (7)	*3	*3	*3	-	-	0.0	-

*1 This is the value for 200 V class drives. Double the value for 400 V class drives.

*2 These values are the default settings for E1-04 to E1-10 and E3-04 to E3-10 [V/f Pattern for Motor 2]. These settings are the same as the settings for the V/f pattern when E1-03 = 0 [Const Trq, 60Hz base, 60Hz max].

*3 The default setting varies depending on the setting of E5-01 [PM Motor Code Selection].

Table 11.3 Parameters Changed by E1-03 (2257 - 2415 and 4140 - 4H12)

No.	E1-03	E1-04	E1-05 *1	E1-06	E1-07	E1-08 *1	E1-09	E1-10 *1
Unit	-	Hz	V	Hz	Hz	V	Hz	V
Setting Value	0	50.0	200.0	50.0	2.5	12.0	1.3	6.0
	1	60.0	200.0	60.0	3.0	12.0	1.5	6.0
	2	60.0	200.0	50.0	3.0	12.0	1.5	6.0
	3	72.0	200.0	60.0	3.0	12.0	1.5	6.0
	4	50.0	200.0	50.0	25.0	35.0	1.3	5.0
	5	50.0	200.0	50.0	25.0	50.0	1.3	6.0
	6	60.0	200.0	60.0	30.0	35.0	1.5	5.0
	7	60.0	200.0	60.0	30.0	50.0	1.5	6.0
	8	50.0	200.0	50.0	2.5	15.0	1.3	7.0
	9	50.0	200.0	50.0	2.5	20.0	1.3	9.0
	A	60.0	200.0	60.0	3.0	15.0	1.5	7.0
	B	60.0	200.0	60.0	3.0	20.0	1.5	11.0
	C	90.0	200.0	60.0	3.0	12.0	1.5	6.0
	D	120.0	200.0	60.0	3.0	12.0	1.5	6.0
	E	180.0	200.0	60.0	3.0	12.0	1.5	6.0
F	50.0 *2	200.0 *2	50.0 *2	2.5 *2	12.0 *2	1.3 *2	6.0 *2	
Control Method Selection (A1-02 Setting)	OLV (2)	50.0	200.0	50.0	3.0	13.2	0.5	2.4
	CLV (3)	50.0	200.0	50.0	0.0	0.0	0.0	0.0
	OLV/PM (5)	*3	*3	*3	-	-	*3	-
	AOLV/PM (6)	*3	*3	*3	-	-	*3	-
	CLV/PM (7)	*3	*3	*3	-	-	0.0	-

*1 This is the value for 200 V class drives. Double the value for 400 V class drives.

*2 These values are the default settings for E1-04 to E1-10 and E3-04 to E3-10 [V/f Pattern for Motor 2]. These settings are the same as the settings for the V/f pattern when E1-03 = 0 [Const Trq, 60Hz base, 60Hz max].

*3 The default setting varies depending on the setting of E5-01 [PM Motor Code Selection].

11.21 Defaults by Drive Model and Duty Rating ND/HD

The values for the parameters in these tables depend on the values for parameters *o2-04* and *C6-01*. Changing the settings for *o2-04* and *C6-01* will change the default settings.

◆ Three-Phase 200 V Class

No. *1	Name	Unit	Default					
			2004		2006		2010	
-	Drive Model	-	HD	ND	HD	ND	HD	ND
C6-01	Normal / Heavy Duty Selection	-	0	1	0	1	0	1
o2-04	Drive Model (KVA) Selection	Hex.	62		63		65	
E2-11 (E4-11)	Motor Rated Power	kW	0.4	0.75	0.75	1.1	1.5	2.2
b3-04	V/f Gain during Speed Search	%	100	100	100	100	100	100
b3-06	Speed Estimation Current Level 1	-	1	1	0.5	0.5	0.5	0.5
b3-07	Speed Estimation Current Level 2	-	1.0	1.0	1.0	1.0	1.0	1.0
b3-08	Speed Estimation ACR P Gain	-	0.5	0.5	0.5	0.5	0.5	0.5
b3-26	Direction Determination Level	-	1000	1000	1000	1000	1000	1000
b8-03	Energy Saving Filter Time	s	0.50	0.50	0.50	0.50	0.50	0.50
b8-04	Energy Saving Coefficient Value	-	288.2	223.7	223.7	196.6	169.4	156.8
C5-17 (C5-37)	Motor Inertia	kgm ²	0.0015	0.0028	0.0028	0.0068	0.0068	0.0088
C6-02	Carrier Frequency Selection	-	1	7	1	7	1	7
E2-01 (E4-01)	Motor Rated Current (FLA)	A	1.9	3.3	3.3	4.9	6.2	8.5
E2-02 (E4-02)	Motor Rated Slip	Hz	2.9	2.5	2.5	2.6	2.6	2.9
E2-03 (E4-03)	Motor No-Load Current	A	1.2	1.8	1.8	2.3	2.8	3
E2-05 (E4-05)	Motor Line-to-Line Resistance	$\Omega/m\Omega$ *2	9.842	5.156	5.156	3.577	1.997	1.601
E2-06 (E4-06)	Motor Leakage Inductance	%	18.2	13.8	13.8	18.5	18.5	18.4
E2-10 (E4-10)	Motor Iron Loss	W	14	26	26	38	53	77
E5-01	PM Motor Code Selection	-	1202	1202	1203	1203	1205	1205
L2-02	Power Loss Ride Through Time	s	0.1	0.1	0.2	0.2	0.3	0.3
L2-03	Minimum Baseblock Time	s	0.2	0.3	0.3	0.4	0.4	0.5
L2-04	Powerloss V/f Recovery Ramp Time	s	0.3	0.3	0.3	0.3	0.3	0.3
L2-05	Undervoltage Detection Lvl (Uv1)	-	190	190	190	190	190	190
L3-24	Motor Accel Time @ Rated Torque	s	0.178	0.142	0.142	0.142	0.166	0.145
L8-02	Overheat Alarm Level	°C	115	115	115	115	115	115

11.21 Defaults by Drive Model and Duty Rating ND/HD

No. */	Name	Unit	Default					
			2004		2006		2010	
-	Drive Model	-						
C6-01	Normal / Heavy Duty Selection	-	HD	ND	HD	ND	HD	ND
			0	1	0	1	0	1
o2-04	Drive Model (KVA) Selection	Hex.	62		63		65	
E2-11 (E4-11)	Motor Rated Power	kW	0.4	0.75	0.75	1.1	1.5	2.2
L8-09	Output Ground Fault Detection	-	1	1	1	1	1	1
L8-38	Carrier Frequency Reduction	-	2	2	2	2	2	2
n1-01	Hunting Prevention Selection	-	1	1	1	1	1	1
n1-03	Hunting Prevention Time Constant	ms	10	10	10	10	10	10
n1-16	Hunting Prevention High Fc Gain	-	0.50	0.50	0.50	0.50	0.50	0.50
n5-02	Motor Inertia Acceleration Time	s	0.178	0.142	0.142	0.142	0.166	0.145

*1 Parameters in parentheses are for motor 2.

*2 The display units are different for different models: The units are Ω for models 2004 to 2415, 4002 to 4675 and m Ω for models 4810 to 4H12.

No. */	Name	Unit	Default							
			2012		2018		2021		2030	
-	Drive Model	-								
C6-01	Normal / Heavy Duty Selection	-	HD	ND	HD	ND	HD	ND	HD	ND
			0	1	0	1	0	1	0	1
o2-04	Drive Model (KVA) Selection	Hex.	66		67		68		6A	
E2-11 (E4-11)	Motor Rated Power	kW	2.2	3.0	3.0	3.7	3.7	5.5	5.5	7.5
b3-04	V/f Gain during Speed Search	%	100	100	100	100	100	100	100	100
b3-06	Speed Estimation Current Level 1	-	0.5	0.5	0.5	0.5	0.5	0.5	0.5	0.5
b3-07	Speed Estimation Current Level 2	-	1.0	1.0	1.0	1.0	1.0	1.0	1.0	1.0
b3-08	Speed Estimation ACR P Gain	-	0.5	0.5	0.5	0.5	0.5	0.5	0.5	0.5
b3-26	Direction Determination Level	-	1000	1000	1000	1000	1000	1000	1000	1000
b8-03	Energy Saving Filter Time	s	0.50	0.50	0.50	0.50	0.50	0.50	0.50	0.50
b8-04	Energy Saving Coefficient Value	-	156.8	136.4	136.4	122.9	122.9	94.75	94.75	72.69
C5-17 (C5-37)	Motor Inertia	kgm ²	0.0088	0.0158	0.0158	0.0158	0.0158	0.0255	0.026	0.037
C6-02	Carrier Frequency Selection	-	1	7	1	7	1	7	1	7
E2-01 (E4-01)	Motor Rated Current (FLA)	A	8.5	11.4	11.4	14	14	19.6	19.6	26.6
E2-02 (E4-02)	Motor Rated Slip	Hz	2.9	2.7	2.7	2.73	2.73	1.5	1.5	1.3

No. */	Name	Unit	Default							
			2012		2018		2021		2030	
-	Drive Model	-								
C6-01	Normal / Heavy Duty Selection	-	HD	ND	HD	ND	HD	ND	HD	ND
			0	1	0	1	0	1	0	1
o2-04	Drive Model (KVA) Selection	Hex.	66		67		68		6A	
E2-11 (E4-11)	Motor Rated Power	kW	2.2	3.0	3.0	3.7	3.7	5.5	5.5	7.5
E2-03 (E4-03)	Motor No-Load Current	A	3	3.7	3.7	4.5	4.5	5.1	5.1	8
E2-05 (E4-05)	Motor Line-to-Line Resistance	Ω/mΩ *2	1.601	1.034	1.034	0.771	0.771	0.399	0.399	0.288
E2-06 (E4-06)	Motor Leakage Inductance	%	18.4	19	19	19.6	19.6	18.2	18.2	15.5
E2-10 (E4-10)	Motor Iron Loss	W	77	91	91	112	112	172	172	262
E5-01	PM Motor Code Selection	-	1206	1206	FFFF	FFFF	1208	1208	120A	120A
L2-02	Power Loss Ride Through Time	s	0.5	0.5	1	1	1	1	1	1
L2-03	Minimum Baseblock Time	s	0.5	0.5	0.5	0.6	0.6	0.7	0.7	0.8
L2-04	Powerloss V/f Recovery Ramp Time	s	0.3	0.3	0.3	0.3	0.3	0.3	0.3	0.3
L2-05	Undervoltage Detection Lvl (Uv1)	-	190	190	190	190	190	190	190	190
L3-24	Motor Accel Time @ Rated Torque	s	0.145	0.145	0.145	0.154	0.154	0.168	0.168	0.175
L8-02	Overheat Alarm Level	°C	124	124	110	110	110	110	110	110
L8-09	Output Ground Fault Detection	-	1	1	1	1	1	1	1	1
L8-38	Carrier Frequency Reduction	-	2	2	2	2	2	2	2	2
n1-01	Hunting Prevention Selection	-	1	1	1	1	1	1	1	1
n1-03	Hunting Prevention Time Constant	ms	10	10	10	10	10	10	10	10
n1-16	Hunting Prevention High Fc Gain	-	0.50	0.50	0.50	0.50	0.50	0.50	0.50	0.50
n5-02	Motor Inertia Acceleration Time	s	0.145	0.145	0.145	0.154	0.154	0.168	0.168	0.175

*1 Parameters in parentheses are for motor 2.

*2 The display units are different for different models: The units are Ω for models 2004 to 2415, 4002 to 4675 and mΩ for models 4810 to 4H12.

11.21 Defaults by Drive Model and Duty Rating ND/HD

No. */	Name	Unit	Default							
			2042		2056		2070		2082	
-	Drive Model	-	HD	ND	HD	ND	HD	ND	HD	ND
C6-01	Normal / Heavy Duty Selection	-	0	1	0	1	0	1	0	1
o2-04	Drive Model (KVA) Selection	Hex.	6B		6D		6E		6F	
E2-11 (E4-11)	Motor Rated Power	kW	7.5	11	11	15	15	18.5	18.5	22
b3-04	V/f Gain during Speed Search	%	100	100	100	100	100	100	100	100
b3-06	Speed Estimation Current Level 1	-	0.5	0.5	0.5	0.5	0.5	0.5	0.5	0.5
b3-07	Speed Estimation Current Level 2	-	1.0	1.0	1.0	1.0	1.0	1.0	1.0	1.0
b3-08	Speed Estimation ACR P Gain	-	0.5	0.5	0.5	0.5	0.5	0.5	0.5	0.5
b3-26	Direction Determination Level	-	1000	1000	1000	1000	1000	1000	1000	1000
b8-03	Energy Saving Filter Time	s	0.50	0.50	0.50	0.50	0.50	0.50	0.50	0.50
b8-04	Energy Saving Coefficient Value	-	72.69	70.44	70.44	63.13	63.13	57.87	57.87	51.79
C5-17 (C5-37)	Motor Inertia	kgm ²	0.037	0.053	0.053	0.076	0.076	0.138	0.138	0.165
C6-02	Carrier Frequency Selection	-	1	7	1	7	1	7	1	7
E2-01 (E4-01)	Motor Rated Current (FLA)	A	26.6	39.7	39.7	53	53	65.8	65.8	77.2
E2-02 (E4-02)	Motor Rated Slip	Hz	1.3	1.7	1.7	1.6	1.6	1.67	1.67	1.7
E2-03 (E4-03)	Motor No-Load Current	A	8	11.2	11.2	15.2	15.2	15.7	15.7	18.5
E2-05 (E4-05)	Motor Line-to-Line Resistance	Ω/mΩ *2	0.288	0.23	0.23	0.138	0.138	0.101	0.101	0.079
E2-06 (E4-06)	Motor Leakage Inductance	%	15.5	19.5	19.5	17.2	17.2	15.7	20.1	19.5
E2-10 (E4-10)	Motor Iron Loss	W	262	245	245	272	272	505	505	538
E5-01	PM Motor Code Selection	-	120B	120B	120D	120D	120E	120E	120F	120F
L2-02	Power Loss Ride Through Time	s	1	1	2	2	2	2	2	2
L2-03	Minimum Baseblock Time	s	0.8	0.9	0.9	1	1	1	1	1
L2-04	Powerloss V/f Recovery Ramp Time	s	0.3	0.3	0.3	0.6	0.6	0.6	0.6	0.6
L2-05	Undervoltage Detection Lvl (Uv1)	-	190	190	190	190	190	190	190	190
L3-24	Motor Accel Time @ Rated Torque	s	0.175	0.265	0.265	0.244	0.244	0.317	0.317	0.355
L8-02	Overheat Alarm Level	°C	110	110	115	115	120	120	133	130

No. */	Name	Unit	Default							
			2042		2056		2070		2082	
-	Drive Model	-								
C6-01	Normal / Heavy Duty Selection	-	HD	ND	HD	ND	HD	ND	HD	ND
			0	1	0	1	0	1	0	1
o2-04	Drive Model (KVA) Selection	Hex.	6B		6D		6E		6F	
E2-11 (E4-11)	Motor Rated Power	kW	7.5	11	11	15	15	18.5	18.5	22
L8-09	Output Ground Fault Detection	-	1	1	1	1	1	1	1	1
L8-38	Carrier Frequency Reduction	-	2	2	2	2	2	2	2	2
n1-01	Hunting Prevention Selection	-	1	1	2	2	2	2	2	2
n1-03	Hunting Prevention Time Constant	ms	10	10	10	10	10	10	10	10
n1-16	Hunting Prevention High Fc Gain	-	0.50	0.50	0.50	0.50	0.50	0.50	0.50	0.50
n5-02	Motor Inertia Acceleration Time	s	0.175	0.265	0.265	0.244	0.244	0.317	0.317	0.355

*1 Parameters in parentheses are for motor 2.

*2 The display units are different for different models: The units are Ω for models 2004 to 2415, 4002 to 4675 and mΩ for models 4810 to 4H12.

No. */	Name	Unit	Default							
			2110		2138		2169		2211	
-	Drive Model	-								
C6-01	Normal / Heavy Duty Selection	-	HD	ND	HD	ND	HD	ND	HD	ND
			0	1	0	1	0	1	0	1
o2-04	Drive Model (KVA) Selection	Hex.	70		72		73		74	
E2-11 (E4-11)	Motor Rated Power	kW	22	30	30	37	37	45	45	55
b3-04	V/F Gain during Speed Search	%	100	80	80	80	80	80	80	80
b3-06	Speed Estimation Current Level 1	-	0.5	0.5	0.5	0.5	0.5	0.5	0.5	0.5
b3-07	Speed Estimation Current Level 2	-	1.0	1.0	1.0	1.0	1.0	1.0	1.0	1.0
b3-08	Speed Estimation ACR P Gain	-	0.5	0.5	0.5	0.5	0.5	0.5	0.5	0.5
b3-26	Direction Determination Level	-	1000	1000	1000	1000	1000	1000	1000	1000
b8-03	Energy Saving Filter Time	s	0.50	0.50	0.50	0.50	0.50	0.50	0.50	2.00
b8-04	Energy Saving Coefficient Value	-	51.79	46.27	46.27	38.16	38.16	35.78	35.78	31.35
C5-17 (C5-37)	Motor Inertia	kgm ²	0.165	0.220	0.220	0.273	0.273	0.333	0.333	0.490
C6-02	Carrier Frequency Selection	-	1	7	1	7	1	7	1	7
E2-01 (E4-01)	Motor Rated Current (FLA)	A	77.2	105	105	131	131	160	160	190

11.21 Defaults by Drive Model and Duty Rating ND/HD

No. */	Name	Unit	Default							
			2110		2138		2169		2211	
-	Drive Model	-	HD	ND	HD	ND	HD	ND	HD	ND
C6-01	Normal / Heavy Duty Selection	-	0	1	0	1	0	1	0	1
o2-04	Drive Model (KVA) Selection	Hex.	70		72		73		74	
E2-11 (E4-11)	Motor Rated Power	kW	22	30	30	37	37	45	45	55
E2-02 (E4-02)	Motor Rated Slip	Hz	1.7	1.8	1.8	1.33	1.33	1.6	1.6	1.43
E2-03 (E4-03)	Motor No-Load Current	A	18.5	21.9	21.9	38.2	38.2	44	44	45.6
E2-05 (E4-05)	Motor Line-to-Line Resistance	$\Omega/m\Omega$ *2	0.079	0.064	0.064	0.039	0.039	0.03	0.03	0.022
E2-06 (E4-06)	Motor Leakage Inductance	%	19.5	20.8	20.8	18.8	18.8	20.2	20.2	20.5
E2-10 (E4-10)	Motor Iron Loss	W	538	699	699	823	823	852	852	960
E5-01	PM Motor Code Selection	-	1210	1210	1212	1212	1213	1213	1214	1214
L2-02	Power Loss Ride Through Time	s	2	2	2	2	2	2	2	2
L2-03	Minimum Baseblock Time	s	1	1.1	1.1	1.1	1.1	1.2	1.2	1.3
L2-04	Powerloss V/f Recovery Ramp Time	s	0.6	0.6	0.6	0.6	0.6	1	1	1
L2-05	Undervoltage Detection Lvl (Uv1)	-	190	190	190	190	190	190	190	190
L3-24	Motor Accel Time @ Rated Torque	s	0.355	0.323	0.323	0.32	0.32	0.387	0.387	0.317
L8-02	Overheat Alarm Level	°C	105	105	115	115	105	105	105	105
L8-09	Output Ground Fault Detection	-	1	1	1	1	1	1	1	1
L8-38	Carrier Frequency Reduction	-	2	2	2	2	2	2	2	2
n1-01	Hunting Prevention Selection	-	2	2	2	2	2	2	2	2
n1-03	Hunting Prevention Time Constant	ms	10	10	10	10	10	10	10	10
n1-16	Hunting Prevention High Fc Gain	-	0.50	0.50	0.50	0.50	0.50	0.50	0.50	0.50
n5-02	Motor Inertia Acceleration Time	s	0.355	0.323	0.323	0.32	0.32	0.387	0.387	0.317

*1 Parameters in parentheses are for motor 2.

*2 The display units are different for different models: The units are Ω for models 2004 to 2415, 4002 to 4675 and $m\Omega$ for models 4810 to 4H12.

No. */	Name	Unit	Default							
			2257		2313		2360		2415	
-	Drive Model	-	HD	ND	HD	ND	HD	ND	HD	ND
C6-01	Normal / Heavy Duty Selection	-	0	1	0	1	0	1	0	1
o2-04	Drive Model (KVA) Selection	Hex.	75		76		77		78	
E2-11 (E4-11)	Motor Rated Power	kW	55	75	75	90	90	110	110	110
b3-04	V/f Gain during Speed Search	%	80	80	80	80	80	80	80	80
b3-06	Speed Estimation Current Level 1	-	0.5	0.7	0.7	0.7	0.7	0.7	0.7	0.7
b3-07	Speed Estimation Current Level 2	-	1.0	1.0	1.0	1.0	1.0	1.0	1.0	1.0
b3-08	Speed Estimation ACR P Gain	-	0.5	0.5	0.5	0.5	0.5	0.5	0.5	0.5
b3-26	Direction Determination Level	-	1000	1000	1000	1000	1000	1000	1000	1000
b8-03	Energy Saving Filter Time	s	2.00	2.00	2.00	2.00	2.00	2.00	2.00	2.00
b8-04	Energy Saving Coefficient Value	-	31.35	23.1	23.1	20.65	20.65	18.12	18.12	18.12
C5-17 (C5-37)	Motor Inertia	kgm ²	0.49	0.90	0.90	1.10	1.10	1.90	1.90	1.90
C6-02	Carrier Frequency Selection	-	1	7	1	7	1	7	1	7
E2-01 (E4-01)	Motor Rated Current (FLA)	A	190	260	260	260	260	260	260	260
E2-02 (E4-02)	Motor Rated Slip	Hz	1.43	1.39	1.39	1.39	1.39	1.39	1.39	1.39
E2-03 (E4-03)	Motor No-Load Current	A	45.6	72	72	72	72	72	72	72
E2-05 (E4-05)	Motor Line-to-Line Resistance	Ω/mΩ *2	0.022	0.023	0.023	0.023	0.023	0.023	0.023	0.023
E2-06 (E4-06)	Motor Leakage Inductance	%	20.5	20	20	20	20	20	20	20
E2-10 (E4-10)	Motor Iron Loss	W	960	1200	1200	1200	1200	1200	1200	1200
E5-01	PM Motor Code Selection	-	1215	1215	1216	1216	FFFF	FFFF	FFFF	FFFF
L2-02	Power Loss Ride Through Time	s	2	2	2	2	2	2	2	2
L2-03	Minimum Baseblock Time	s	1.3	1.5	1.5	1.5	1.5	1.7	1.7	1.7
L2-04	Powerloss V/f Recovery Ramp Time	s	1	1	1	1	1	1	1	1
L2-05	Undervoltage Detection Lvl (Uv1)	-	190	190	190	190	190	190	190	190
L3-24	Motor Accel Time @ Rated Torque	s	0.317	0.533	0.533	0.592	0.592	0.646	0.646	0.646
L8-02	Overheat Alarm Level	°C	105	105	105	105	105	105	105	105

11.21 Defaults by Drive Model and Duty Rating ND/HD

No. */	Name	Unit	Default							
			2257		2313		2360		2415	
-	Drive Model	-								
C6-01	Normal / Heavy Duty Selection	-	HD	ND	HD	ND	HD	ND	HD	ND
			0	1	0	1	0	1	0	1
o2-04	Drive Model (KVA) Selection	Hex.	75		76		77		78	
E2-11 (E4-11)	Motor Rated Power	kW	55	75	75	90	90	110	110	110
L8-09	Output Ground Fault Detection	-	1	1	1	1	1	1	1	1
L8-38	Carrier Frequency Reduction	-	2	2	2	2	2	2	2	2
n1-01	Hunting Prevention Selection	-	2	2	2	2	2	2	2	2
n1-03	Hunting Prevention Time Constant	ms	10	10	10	10	100	100	100	100
n1-16	Hunting Prevention High Fc Gain	-	0.50	0.50	0.50	0.50	1.00	1.00	1.00	1.00
n5-02	Motor Inertia Acceleration Time	s	0.317	0.533	0.533	0.592	0.592	0.646	0.646	0.646

*1 Parameters in parentheses are for motor 2.

*2 The display units are different for different models: The units are Ω for models 2004 to 2415, 4002 to 4675 and m Ω for models 4810 to 4H12.

◆ Three-Phase 400 V Class

No. */	Name	Unit	Default							
			4002		4004		4005		4007	
-	Drive Model	-								
C6-01	Normal / Heavy Duty Selection	-	HD	ND	HD	ND	HD	ND	HD	ND
			0	1	0	1	0	1	0	1
o2-04	Drive Model (KVA) Selection	Hex.	92		93		94		95	
E2-11 (E4-11)	Motor Rated Power	kW	0.4	0.75	1.1	1.5	1.5	2.2	2.2	3.0
b3-04	V/f Gain during Speed Search	%	100	100	100	100	100	100	100	100
b3-06	Speed Estimation Current Level 1	-	0.5	0.5	0.5	0.5	0.5	0.5	0.5	0.5
b3-07	Speed Estimation Current Level 2	-	1.0	1.0	1.0	1.0	1.0	1.0	1.0	1.0
b3-08	Speed Estimation ACR P Gain	-	0.5	0.5	0.5	0.5	0.5	0.5	0.5	0.5
b3-26	Direction Determination Level	-	1000	1000	1000	1000	1000	1000	1000	1000
b8-03	Energy Saving Filter Time	s	0.50	0.50	0.50	0.50	0.50	0.50	0.50	0.50
b8-04	Energy Saving Coefficient Value	-	576.4	447.4	447.4	338.8	338.8	313.6	313.6	265.7
C5-17 (C5-37)	Motor Inertia	kgm ²	0.0015	0.0028	0.0028	0.0068	0.0068	0.0088	0.0088	0.0158
C6-02	Carrier Frequency Selection	-	1	7	1	7	1	7	1	7

No. */	Name	Unit	Default							
			4002		4004		4005		4007	
-	Drive Model	-	HD	ND	HD	ND	HD	ND	HD	ND
C6-01	Normal / Heavy Duty Selection	-	0	1	0	1	0	1	0	1
o2-04	Drive Model (KVA) Selection	Hex.	92		93		94		95	
E2-11 (E4-11)	Motor Rated Power	kW	0.4	0.75	1.1	1.5	1.5	2.2	2.2	3.0
E2-01 (E4-01)	Motor Rated Current (FLA)	A	1	1.6	1.6	3.1	3.1	4.2	4.2	5.7
E2-02 (E4-02)	Motor Rated Slip	Hz	2.9	2.6	2.6	2.5	2.5	3	3	2.7
E2-03 (E4-03)	Motor No-Load Current	A	0.6	0.8	0.8	1.4	1.4	1.5	1.5	1.9
E2-05 (E4-05)	Motor Line-to-Line Resistance	$\Omega/m\Omega$ *2	38.198	22.459	22.459	10.1	10.1	6.495	6.495	4.360
E2-06 (E4-06)	Motor Leakage Inductance	%	18.2	14.3	14.3	18.3	18.3	18.7	18.7	19
E2-10 (E4-10)	Motor Iron Loss	W	14	26	26	53	53	77	77	105
E5-01	PM Motor Code Selection	-	1232	1232	1233	1233	1235	1235	1236	1236
L2-02	Power Loss Ride Through Time	s	0.1	0.1	0.2	0.2	0.3	0.3	0.5	0.5
L2-03	Minimum Baseblock Time	s	0.2	0.3	0.3	0.4	0.4	0.5	0.5	0.5
L2-04	Powerloss V/f Recovery Ramp Time	s	0.3	0.3	0.3	0.3	0.3	0.3	0.3	0.3
L2-05	Undervoltage Detection Lvl (Uv1)	-	380	380	380	380	380	380	380	380
L3-24	Motor Accel Time @ Rated Torque	s	0.178	0.142	0.142	0.166	0.166	0.145	0.145	0.145
L8-02	Overheat Alarm Level	°C	100	100	105	105	112	112	100	100
L8-09	Output Ground Fault Detection	-	1	1	1	1	1	1	1	1
L8-38	Carrier Frequency Reduction	-	2	2	2	2	2	2	2	2
n1-01	Hunting Prevention Selection	-	1	1	1	1	1	1	1	1
n1-03	Hunting Prevention Time Constant	ms	10	10	10	10	10	10	10	10
n1-16	Hunting Prevention High Fc Gain	-	0.50	0.50	0.50	0.50	0.50	0.50	0.50	0.50
n5-02	Motor Inertia Acceleration Time	s	0.178	0.142	0.142	0.166	0.166	0.145	0.145	0.145

*1 Parameters in parentheses are for motor 2.

*2 The display units are different for different models: The units are Ω for models 2004 to 2415, 4002 to 4675 and $m\Omega$ for models 4810 to 4H12.

11.21 Defaults by Drive Model and Duty Rating ND/HD

No. */	Name	Unit	Default							
			4009		4012		4018		4023	
-	Drive Model	-	HD	ND	HD	ND	HD	ND	HD	ND
C6-01	Normal / Heavy Duty Selection	-	0	1	0	1	0	1	0	1
o2-04	Drive Model (KVA) Selection	Hex.	96		97		99		9A	
E2-11 (E4-11)	Motor Rated Power	kW	3.0	4.0	4.0	5.5	5.5	7.5	7.5	11
b3-04	V/f Gain during Speed Search	%	100	100	100	100	100	100	100	100
b3-06	Speed Estimation Current Level 1	-	0.5	0.5	0.5	0.5	0.5	0.5	0.5	0.5
b3-07	Speed Estimation Current Level 2	-	1.0	1.0	1.0	1.0	1.0	1.0	1.0	1.0
b3-08	Speed Estimation ACR P Gain	-	0.5	0.5	0.5	0.5	0.5	0.5	0.5	0.5
b3-26	Direction Determination Level	-	1000	1000	1000	1000	1000	1000	1000	1000
b8-03	Energy Saving Filter Time	s	0.50	0.50	0.50	0.50	0.50	0.50	0.50	0.50
b8-04	Energy Saving Coefficient Value	-	265.7	245.8	245.8	189.5	189.5	145.38	145.38	140.88
C5-17 (C5-37)	Motor Inertia	kgm ²	0.0158	0.0158	0.0158	0.0255	0.026	0.037	0.037	0.053
C6-02	Carrier Frequency Selection	-	1	7	1	7	1	7	1	7
E2-01 (E4-01)	Motor Rated Current (FLA)	A	5.7	7	7	9.8	9.8	13.3	13.3	19.9
E2-02 (E4-02)	Motor Rated Slip	Hz	2.7	2.7	2.7	1.5	1.5	1.3	1.3	1.7
E2-03 (E4-03)	Motor No-Load Current	A	1.9	2.3	2.3	2.6	2.6	4	4	5.6
E2-05 (E4-05)	Motor Line-to-Line Resistance	$\Omega/m\Omega$ *2	4.360	3.333	3.333	1.595	1.595	1.152	1.152	0.922
E2-06 (E4-06)	Motor Leakage Inductance	%	19	19.3	19.3	18.2	18.2	15.5	15.5	19.6
E2-10 (E4-10)	Motor Iron Loss	W	105	130	130	193	193	263	263	385
E5-01	PM Motor Code Selection	-	FFFF	FFFF	1238	1238	123A	123A	123B	123B
L2-02	Power Loss Ride Through Time	s	0.5	0.5	0.5	0.5	0.8	0.8	1	1
L2-03	Minimum Baseblock Time	s	0.5	0.6	0.6	0.7	0.7	0.8	0.8	0.9
L2-04	Powerloss V/f Recovery Ramp Time	s	0.3	0.3	0.3	0.3	0.3	0.3	0.3	0.3
L2-05	Undervoltage Detection Lvl (Uv1)	-	380	380	380	380	380	380	380	380
L3-24	Motor Accel Time @ Rated Torque	s	0.145	0.154	0.154	0.168	0.168	0.175	0.175	0.265
L8-02	Overheat Alarm Level	°C	100	100	100	100	105	105	105	105

No. */	Name	Unit	Default							
			4009		4012		4018		4023	
-	Drive Model	-	HD	ND	HD	ND	HD	ND	HD	ND
C6-01	Normal / Heavy Duty Selection	-	0	1	0	1	0	1	0	1
o2-04	Drive Model (KVA) Selection	Hex.	96		97		99		9A	
E2-11 (E4-11)	Motor Rated Power	kW	3.0	4.0	4.0	5.5	5.5	7.5	7.5	11
L8-09	Output Ground Fault Detection	-	1	1	1	1	1	1	1	1
L8-38	Carrier Frequency Reduction	-	2	2	2	2	2	2	2	2
n1-01	Hunting Prevention Selection	-	1	1	1	1	1	1	1	1
n1-03	Hunting Prevention Time Constant	ms	10	10	10	10	10	10	10	10
n1-16	Hunting Prevention High Fc Gain	-	0.50	0.50	0.50	0.50	0.50	0.50	0.50	0.50
n5-02	Motor Inertia Acceleration Time	s	0.145	0.154	0.154	0.168	0.168	0.175	0.175	0.265

*1 Parameters in parentheses are for motor 2.

*2 The display units are different for different models: The units are Ω for models 2004 to 2415, 4002 to 4675 and mΩ for models 4810 to 4H12.

No. */	Name	Unit	Default							
			4031		4038		4044		4060	
-	Drive Model	-	HD	ND	HD	ND	HD	ND	HD	ND
C6-01	Normal / Heavy Duty Selection	-	0	1	0	1	0	1	0	1
o2-04	Drive Model (KVA) Selection	Hex.	9C		9D		9E		9F	
E2-11 (E4-11)	Motor Rated Power	kW	11	15	15	18.5	18.5	22	22	30
b3-04	V/F Gain during Speed Search	%	100	100	100	100	100	100	100	100
b3-06	Speed Estimation Current Level 1	-	0.5	0.5	0.5	0.5	0.5	0.5	0.5	0.5
b3-07	Speed Estimation Current Level 2	-	1.0	1.0	1.0	1.0	1.0	1.0	1.0	1.0
b3-08	Speed Estimation ACR P Gain	-	0.5	0.5	0.5	0.5	0.5	0.5	0.5	0.5
b3-26	Direction Determination Level	-	1000	1000	1000	1000	1000	1000	1000	1000
b8-03	Energy Saving Filter Time	s	0.50	0.50	0.50	0.50	0.50	0.50	0.50	0.50
b8-04	Energy Saving Coefficient Value	-	140.88	126.26	126.26	115.74	115.74	103.58	103.58	92.54
C5-17 (C5-37)	Motor Inertia	kgm ²	0.053	0.076	0.076	0.138	0.138	0.165	0.165	0.220
C6-02	Carrier Frequency Selection	-	1	7	1	7	1	7	1	7
E2-01 (E4-01)	Motor Rated Current (FLA)	A	19.9	26.5	26.5	32.9	32.9	38.6	38.6	52.3

11.21 Defaults by Drive Model and Duty Rating ND/HD

No. */	Name	Unit	Default							
			4031		4038		4044		4060	
-	Drive Model	-	HD	ND	HD	ND	HD	ND	HD	ND
C6-01	Normal / Heavy Duty Selection	-	0	1	0	1	0	1	0	1
o2-04	Drive Model (KVA) Selection	Hex.	9C		9D		9E		9F	
E2-11 (E4-11)	Motor Rated Power	kW	11	15	15	18.5	18.5	22	22	30
E2-02 (E4-02)	Motor Rated Slip	Hz	1.7	1.6	1.6	1.67	1.67	1.7	1.7	1.8
E2-03 (E4-03)	Motor No-Load Current	A	5.6	7.6	7.6	7.8	7.8	9.2	9.2	10.9
E2-05 (E4-05)	Motor Line-to-Line Resistance	$\Omega/m\Omega$ *2	0.922	0.55	0.55	0.403	0.403	0.316	0.316	0.269
E2-06 (E4-06)	Motor Leakage Inductance	%	19.6	17.2	17.2	20.1	20.1	23.5	23.5	20.7
E2-10 (E4-10)	Motor Iron Loss	W	385	440	440	508	508	586	586	750
E5-01	PM Motor Code Selection	-	123D	123D	123E	123E	123F	123F	1240	1240
L2-02	Power Loss Ride Through Time	s	2	2	2	2	2	2	2	2
L2-03	Minimum Baseblock Time	s	0.9	1	1	1	1	1	1	1.1
L2-04	Powerloss V/f Recovery Ramp Time	s	0.3	0.6	0.6	0.6	0.6	0.6	0.6	0.6
L2-05	Undervoltage Detection Lvl (Uv1)	-	380	380	380	380	380	380	380	380
L3-24	Motor Accel Time @ Rated Torque	s	0.265	0.244	0.244	0.317	0.317	0.355	0.355	0.323
L8-02	Overheat Alarm Level	°C	115	115	120	120	120	120	130	137
L8-09	Output Ground Fault Detection	-	1	1	1	1	1	1	1	1
L8-38	Carrier Frequency Reduction	-	2	2	2	2	2	2	2	2
n1-01	Hunting Prevention Selection	-	2	2	2	2	2	2	2	2
n1-03	Hunting Prevention Time Constant	ms	10	10	10	10	10	10	10	10
n1-16	Hunting Prevention High Fc Gain	-	0.50	0.50	0.50	0.50	0.50	0.50	0.50	0.50
n5-02	Motor Inertia Acceleration Time	s	0.265	0.244	0.244	0.317	0.317	0.355	0.355	0.323

*1 Parameters in parentheses are for motor 2.

*2 The display units are different for different models: The units are Ω for models 2004 to 2415, 4002 to 4675 and $m\Omega$ for models 4810 to 4H12.

No. */	Name	Unit	Default							
			4075		4089		4103		4140	
-	Drive Model	-	HD	ND	HD	ND	HD	ND	HD	ND
C6-01	Normal / Heavy Duty Selection	-	0	1	0	1	0	1	0	1
o2-04	Drive Model (KVA) Selection	Hex.	A1		A2		A3		A4	
E2-11 (E4-11)	Motor Rated Power	kW	30	37	37	45	45	55	55	75
b3-04	V/f Gain during Speed Search	%	100	100	100	100	100	80	80	60
b3-06	Speed Estimation Current Level 1	-	0.5	0.5	0.5	0.5	0.5	0.5	0.5	0.7
b3-07	Speed Estimation Current Level 2	-	1.0	1.0	1.0	1.0	1.0	1.0	1.0	1.0
b3-08	Speed Estimation ACR P Gain	-	0.5	0.5	0.5	0.5	0.5	0.5	0.5	0.8
b3-26	Direction Determination Level	-	1000	1000	1000	1000	1000	1000	1000	1000
b8-03	Energy Saving Filter Time	s	0.50	0.50	0.50	0.50	0.50	2.00	2.00	2.00
b8-04	Energy Saving Coefficient Value	-	92.54	76.32	76.32	71.56	71.56	67.2	67.2	46.2
C5-17 (C5-37)	Motor Inertia	kgm ²	0.220	0.273	0.273	0.333	0.333	0.490	0.49	0.90
C6-02	Carrier Frequency Selection	-	1	7	1	7	1	7	1	7
E2-01 (E4-01)	Motor Rated Current (FLA)	A	52.3	65.6	65.6	79.7	79.7	95	95	130
E2-02 (E4-02)	Motor Rated Slip	Hz	1.8	1.33	1.33	1.6	1.6	1.46	1.46	1.39
E2-03 (E4-03)	Motor No-Load Current	A	10.9	19.1	19.1	22	22	24	24	36
E2-05 (E4-05)	Motor Line-to-Line Resistance	Ω/mΩ *2	0.269	0.155	0.155	0.122	0.122	0.088	0.088	0.092
E2-06 (E4-06)	Motor Leakage Inductance	%	20.7	18.8	18.8	19.9	19.9	20	20	20
E2-10 (E4-10)	Motor Iron Loss	W	750	925	925	1125	1125	1260	1260	1600
E5-01	PM Motor Code Selection	-	1242	1242	1243	1243	1244	1244	1245	1245
L2-02	Power Loss Ride Through Time	s	2	2	2	2	2	2	2	2
L2-03	Minimum Baseblock Time	s	1.1	1.1	1.1	1.2	1.2	1.2	1.2	1.3
L2-04	Powerloss V/f Recovery Ramp Time	s	0.6	0.6	0.6	0.6	0.6	1	1	1
L2-05	Undervoltage Detection Lvl (Uv1)	-	380	380	380	380	380	380	380	380
L3-24	Motor Accel Time @ Rated Torque	s	0.323	0.32	0.32	0.387	0.387	0.317	0.317	0.533
L8-02	Overheat Alarm Level	°C	120	120	115	115	126	120	120	120

11.21 Defaults by Drive Model and Duty Rating ND/HD

No. */	Name	Unit	Default							
			4075		4089		4103		4140	
-	Drive Model	-								
C6-01	Normal / Heavy Duty Selection	-	HD	ND	HD	ND	HD	ND	HD	ND
			0	1	0	1	0	1	0	1
o2-04	Drive Model (KVA) Selection	Hex.	A1		A2		A3		A4	
E2-11 (E4-11)	Motor Rated Power	kW	30	37	37	45	45	55	55	75
L8-09	Output Ground Fault Detection	-	1	1	1	1	1	1	1	1
L8-38	Carrier Frequency Reduction	-	2	2	2	2	2	2	2	2
n1-01	Hunting Prevention Selection	-	2	2	2	2	2	2	2	2
n1-03	Hunting Prevention Time Constant	ms	10	10	10	10	10	10	30	30
n1-16	Hunting Prevention High Fc Gain	-	0.50	0.50	0.50	0.50	0.50	0.50	0.50	0.50
n5-02	Motor Inertia Acceleration Time	s	0.323	0.32	0.32	0.387	0.387	0.317	0.317	0.533

*1 Parameters in parentheses are for motor 2.

*2 The display units are different for different models: The units are Ω for models 2004 to 2415, 4002 to 4675 and m Ω for models 4810 to 4H12.

No. */	Name	Unit	Default							
			4168		4208		4250		4296	
-	Drive Model	-								
C6-01	Normal / Heavy Duty Selection	-	HD	ND	HD	ND	HD	ND	HD	ND
			0	1	0	1	0	1	0	1
o2-04	Drive Model (KVA) Selection	Hex.	A5		A6		A7		A8	
E2-11 (E4-11)	Motor Rated Power	kW	75	90	90	110	110	150	150	185
b3-04	V/f Gain during Speed Search	%	60	60	60	60	60	60	60	60
b3-06	Speed Estimation Current Level 1	-	0.7	0.7	0.7	0.7	0.7	0.7	0.7	0.7
b3-07	Speed Estimation Current Level 2	-	1.0	1.0	1.0	1.0	1.0	1.0	1.0	1.0
b3-08	Speed Estimation ACR P Gain	-	0.8	0.8	0.8	0.8	0.8	0.8	0.8	0.8
b3-26	Direction Determination Level	-	1000	1000	1000	1000	1000	1000	1000	1000
b8-03	Energy Saving Filter Time	s	2.00	2.00	2.00	2.00	2.00	2.00	2.00	2.00
b8-04	Energy Saving Coefficient Value	-	46.2	38.91	38.91	36.23	36.23	32.79	32.79	30.13
C5-17 (C5-37)	Motor Inertia	kgm ²	0.90	1.10	1.10	1.90	1.90	2.10	2.10	3.30
C6-02	Carrier Frequency Selection	-	1	7	1	7	1	7	1	7
E2-01 (E4-01)	Motor Rated Current (FLA)	A	130	156	156	190	190	223	223	270

No. */	Name	Unit	Default							
			4168		4208		4250		4296	
-	Drive Model	-								
C6-01	Normal / Heavy Duty Selection	-	HD	ND	HD	ND	HD	ND	HD	ND
			0	1	0	1	0	1	0	1
o2-04	Drive Model (KVA) Selection	Hex.	A5		A6		A7		A8	
E2-11 (E4-11)	Motor Rated Power	kW	75	90	90	110	110	150	150	185
E2-02 (E4-02)	Motor Rated Slip	Hz	1.39	1.4	1.4	1.4	1.4	1.38	1.38	1.35
E2-03 (E4-03)	Motor No-Load Current	A	36	40	40	49	49	58	58	70
E2-05 (E4-05)	Motor Line-to-Line Resistance	Ω/mΩ *2	0.092	0.056	0.056	0.046	0.046	0.035	0.035	0.029
E2-06 (E4-06)	Motor Leakage Inductance	%	20	20	20	20	20	20	20	20
E2-10 (E4-10)	Motor Iron Loss	W	1600	1760	1760	2150	2150	2350	2350	2850
E5-01	PM Motor Code Selection	-	1246	1246	1247	1247	1248	1248	1249	1249
L2-02	Power Loss Ride Through Time	s	2	2	2	2	2	2	2	2
L2-03	Minimum Baseblock Time	s	1.3	1.5	1.5	1.7	1.7	1.7	1.7	1.8
L2-04	Powerloss V/f Recovery Ramp Time	s	1	1	1	1	1	1	1	1
L2-05	Undervoltage Detection Lvl (Uv1)	-	380	380	380	380	380	380	380	380
L3-24	Motor Accel Time @ Rated Torque	s	0.533	0.592	0.592	0.646	0.646	0.673	0.673	0.777
L8-02	Overheat Alarm Level	°C	110	110	105	105	120	120	120	120
L8-09	Output Ground Fault Detection	-	1	1	1	1	1	1	1	1
L8-38	Carrier Frequency Reduction	-	2	2	2	2	2	2	2	2
n1-01	Hunting Prevention Selection	-	2	2	2	2	2	2	2	2
n1-03	Hunting Prevention Time Constant	ms	30	30	30	30	30	30	30	30
n1-16	Hunting Prevention High Fc Gain	-	0.50	0.50	0.50	0.50	0.50	0.50	0.50	0.50
n5-02	Motor Inertia Acceleration Time	s	0.533	0.592	0.592	0.646	0.646	0.673	0.673	0.777

*1 Parameters in parentheses are for motor 2.

*2 The display units are different for different models: The units are Ω for models 2004 to 2415, 4002 to 4675 and mΩ for models 4810 to 4H12.

11.21 Defaults by Drive Model and Duty Rating ND/HD

No. */	Name	Unit	Default							
			4371		4389		4453		4568	
-	Drive Model	-	HD	ND	HD	ND	HD	ND	HD	ND
C6-01	Normal / Heavy Duty Selection	-	0	1	0	1	0	1	0	1
o2-04	Drive Model (KVA) Selection	Hex.	A9		AA		AC		AD	
E2-11 (E4-11)	Motor Rated Power	kW	185	220	220	260	260	300	300	335
b3-04	V/f Gain during Speed Search	%	60	60	60	60	60	60	60	60
b3-06	Speed Estimation Current Level 1	-	0.7	0.7	0.7	0.7	0.7	0.7	0.7	0.7
b3-07	Speed Estimation Current Level 2	-	1.0	1.0	1.0	1.0	1.0	1.0	1.0	1.0
b3-08	Speed Estimation ACR P Gain	-	0.8	0.8	0.8	0.8	0.8	0.8	0.8	0.8
b3-26	Direction Determination Level	-	1000	1000	1000	1000	1000	1000	1000	1000
b8-03	Energy Saving Filter Time	s	2.00	2.00	2.00	2.00	2.00	2.00	2.00	2.00
b8-04	Energy Saving Coefficient Value	-	30.13	30.57	30.57	27.13	27.13	21.76	21.76	21.76
C5-17 (C5-37)	Motor Inertia	kgm ²	3.30	3.60	3.60	4.10	4.10	6.50	6.50	11.00
C6-02	Carrier Frequency Selection	-	1	7	1	7	1	7	1	7
E2-01 (E4-01)	Motor Rated Current (FLA)	A	270	310	310	370	370	500	500	500
E2-02 (E4-02)	Motor Rated Slip	Hz	1.35	1.3	1.3	1.3	1.3	1.25	1.25	1.25
E2-03 (E4-03)	Motor No-Load Current	A	70	81	81	96	96	130	130	130
E2-05 (E4-05)	Motor Line-to-Line Resistance	Ω/mΩ *2	0.029	0.025	0.025	0.02	0.02	0.014	0.014	0.014
E2-06 (E4-06)	Motor Leakage Inductance	%	20	20	20	20	20	20	20	20
E2-10 (E4-10)	Motor Iron Loss	W	2850	3200	3200	3700	3700	4700	4700	4700
E5-01	PM Motor Code Selection	-	124A	124A	124A	124A	124A	124A	124A	124A
L2-02	Power Loss Ride Through Time	s	2	2	2	2	2	2	2	2
L2-03	Minimum Baseblock Time	s	1.8	1.9	1.9	2	2	2.1	2.1	2.1
L2-04	Powerloss V/f Recovery Ramp Time	s	1	1	1.8	1.8	1.8	2	2	2
L2-05	Undervoltage Detection Lvl (Uv1)	-	380	380	380	380	380	380	380	380
L3-24	Motor Accel Time @ Rated Torque	s	0.777	0.864	0.864	0.91	0.91	1.392	1.392	1.392
L8-02	Overheat Alarm Level	°C	125	125	125	125	110	110	125	115

No. */	Name	Unit	Default							
			4371		4389		4453		4568	
-	Drive Model	-	HD	ND	HD	ND	HD	ND	HD	ND
C6-01	Normal / Heavy Duty Selection	-	0	1	0	1	0	1	0	1
o2-04	Drive Model (KVA) Selection	Hex.	A9		AA		AC		AD	
E2-11 (E4-11)	Motor Rated Power	kW	185	220	220	260	260	300	300	335
L8-09	Output Ground Fault Detection	-	1	1	1	1	1	1	1	1
L8-38	Carrier Frequency Reduction	-	2	2	2	2	2	2	2	2
n1-01	Hunting Prevention Selection	-	2	2	2	2	2	2	2	2
n1-03	Hunting Prevention Time Constant	ms	30	30	100	100	100	100	100	100
n1-16	Hunting Prevention High Fc Gain	-	0.50	0.50	0.50	0.50	0.50	0.50	0.50	0.50
n5-02	Motor Inertia Acceleration Time	s	0.777	0.864	0.864	0.91	0.91	1.392	1.392	1.392

*1 Parameters in parentheses are for motor 2.

*2 The display units are different for different models: The units are Ω for models 2004 to 2415, 4002 to 4675 and mΩ for models 4810 to 4H12.

No. */	Name	Unit	Default							
			4675		4810		4930		4H11	
-	Drive Model	-	HD1	ND	HD	ND	HD	ND	HD	ND
C6-01	Normal / Heavy Duty Selection	-	0	1	0	1	0	1	0	1
o2-04	Drive Model (KVA) Selection	Hex.	AE		B0		B1		B2	
E2-11 (E4-11)	Motor Rated Power	kW	315	355	450	525	525	600	600	675
b3-04	V/F Gain during Speed Search	%	60	60	40	40	40	40	40	40
b3-06	Speed Estimation Current Level 1	-	0.7	0.7	0.7	0.7	0.7	0.7	0.7	0.7
b3-07	Speed Estimation Current Level 2	-	1.0	1.0	3.0	2.0	3.0	2.0	3.0	2.0
b3-08	Speed Estimation ACR P Gain	-	0.8	0.8	0.8	0.8	0.8	0.8	0.8	0.8
b3-26	Direction Determination Level	-	1000	1000	1000	1000	1000	1000	1000	1000
b8-03	Energy Saving Filter Time	s	2.00	2.00	2.00	2.00	2.00	2.00	2.00	2.00
b8-04	Energy Saving Coefficient Value	-	21.76	23.84	23.84	21.4	21.4	20.26	20.26	18.12
C5-17 (C5-37)	Motor Inertia	kgm ²	11.00	12.00	12.00	13.00	13.00	14.00	14.00	18.00
C6-02	Carrier Frequency Selection	-	1	7	1	1	1	1	1	1
E2-01 (E4-01)	Motor Rated Current (FLA)	A	500	650	650	800	800	900	900	1090

11.21 Defaults by Drive Model and Duty Rating ND/HD

No. */	Name	Unit	Default							
			4675		4810		4930		4H11	
-	Drive Model	-								
C6-01	Normal / Heavy Duty Selection	-	HD1	ND	HD	ND	HD	ND	HD	ND
			0	1	0	1	0	1	0	1
o2-04	Drive Model (KVA) Selection	Hex.	AE		B0		B1		B2	
E2-11 (E4-11)	Motor Rated Power	kW	315	355	450	525	525	600	600	675
E2-02 (E4-02)	Motor Rated Slip	Hz	1.25	1	1	1	1	0.9	0.9	0.8
E2-03 (E4-03)	Motor No-Load Current	A	130	130	130	160	160	180	180	218
E2-05 (E4-05)	Motor Line-to-Line Resistance	$\Omega/m\Omega$ *2	0.014	0.012	12.000	10.000	10.000	9.000	9.000	7.000
E2-06 (E4-06)	Motor Leakage Inductance	%	20	20	20	20	20	20	20	20
E2-10 (E4-10)	Motor Iron Loss	W	4700	5560	5560	7050	7050	7833	7833	9870
E5-01	PM Motor Code Selection	-	FFFF	FFFF	-	-	-	-	-	-
L2-02	Power Loss Ride Through Time	s	2	2	2	2	2	2	2	2
L2-03	Minimum Baseblock Time	s	2.1	2.3	2.3	2.8	2.8	3.1	3.1	4
L2-04	Powerloss V/f Recovery Ramp Time	s	2	2.2	2.2	2.6	2.6	3	3	3.8
L2-05	Undervoltage Detection Lvl (Uv1)	-	380	380	380	380	380	380	380	380
L3-24	Motor Accel Time @ Rated Torque	s	1.392	1.667	1.667	2	2	2.222	2.222	2.857
L8-02	Overheat Alarm Level	°C	133	133	120	120	120	120	120	120
L8-09	Output Ground Fault Detection	-	1	1	1	1	1	1	1	1
L8-38	Carrier Frequency Reduction	-	2	2	2	2	2	2	2	2
n1-01	Hunting Prevention Selection	-	2	2	2	2	2	2	2	2
n1-03	Hunting Prevention Time Constant	ms	100	100	100	100	100	100	100	100
n1-16	Hunting Prevention High Fc Gain	-	0.50	0.50	0.50	0.50	0.50	0.50	0.50	0.50
n5-02	Motor Inertia Acceleration Time	s	1.392	1.667	1.667	2	2	2.222	2.222	2.857

*1 Parameters in parentheses are for motor 2.

*2 The display units are different for different models: The units are Ω for models 2004 to 2415, 4002 to 4675 and $m\Omega$ for models 4810 to 4H12.

No. */	Name	Unit	4H12	
-	Drive Model	-	4H12	
C6-01	Normal / Heavy Duty Selection	-	HD	ND
			0	1
o2-04	Drive Model (KVA) Selection	Hex.	B3	
E2-11 (E4-11)	Motor Rated Power	kW	675	750
b3-04	V/f Gain during Speed Search	%	40	40
b3-06	Speed Estimation Current Level 1	-	0.7	0.7
b3-07	Speed Estimation Current Level 2	-	3.0	2.0
b3-08	Speed Estimation ACR P Gain	-	0.8	0.8
b3-26	Direction Determination Level	-	1000	1000
b8-03	Energy Saving Filter Time	s	2.00	2.00
b8-04	Energy Saving Coefficient Value	-	18.12	17.06
C5-17 (C5-37)	Motor Inertia	kgm ²	18.00	18.00
C6-02	Carrier Frequency Selection	-	1	1
E2-01 (E4-01)	Motor Rated Current (FLA)	A	1090	1200
E2-02 (E4-02)	Motor Rated Slip	Hz	0.8	0.7
E2-03 (E4-03)	Motor No-Load Current	A	218	240
E2-05 (E4-05)	Motor Line-to-Line Resistance	$\Omega/\text{m}\Omega$ *2	7.000m Ω	6.000m Ω
E2-06 (E4-06)	Motor Leakage Inductance	%	20	20
E2-10 (E4-10)	Motor Iron Loss	W	9870	11123
E5-01	PM Motor Code Selection	-	-	-
L2-02	Power Loss Ride Through Time	s	2	2
L2-03	Minimum Baseblock Time	s	4	4.6
L2-04	Powerloss V/f Recovery Ramp Time	s	3.8	4.5
L2-05	Undervoltage Detection Lvl (Uv1)	-	380	380
L3-24	Motor Accel Time @ Rated Torque	s	2.857	3.333
L8-02	Overheat Alarm Level	°C	120	120
L8-09	Output Ground Fault Detection	-	1	1
L8-38	Carrier Frequency Reduction	-	2	2
n1-01	Hunting Prevention Selection	-	2	2
n1-03	Hunting Prevention Time Constant	ms	100	100
n1-16	Hunting Prevention High Fc Gain	-	0.50	0.50
n5-02	Motor Inertia Acceleration Time	s	2.857	3.333

*1 Parameters in parentheses are for motor 2.

*2 The display units are different for different models: The units are Ω for models 2004 to 2415, 4002 to 4675 and m Ω for models 4810 to 4H12.

Parameter Details

12.1	Section Safety	658
12.2	A: Initialization Parameters.....	659
12.3	b: Application	680
12.4	C: Tuning	731
12.5	d: References	756
12.6	E: Motor Parameters	778
12.7	F: Options	798
12.8	H: Terminal Functions	838
12.9	L: Protection Functions	911
12.10	n: Special Adjustment.....	958
12.11	o: Keypad-Related Settings.....	981
12.12	T: Auto-Tuning.....	1005

12.1 Section Safety

 **DANGER**

Do not ignore the safety messages in this manual.

If you ignore the safety messages in this manual, it will cause serious injury or death. The manufacturer is not responsible for injuries or damage to equipment.

12.2 A: Initialization Parameters

A parameters [Initialization Parameters] set the operating environment and operating conditions for the drive.

◆ A1: Initialization

A1 parameters set the operating environment and operating conditions for the drive. For example, these parameters set the keypad language, the control method, and the parameter access level for the drive.

■ A1-00: Language Selection

No. (Hex.)	Name	Description	Default (Range)
A1-00 (0100) RUN	Language Selection	V/f CL-V/f OLV CLV AOLV OLV/PM AOLV/PM CLV/PM EZOLV Sets the language for the LCD keypad.	0 (0 - 12)

Note:

- This parameter is only available when you use an LCD keypad or a Bluetooth LCD Keypad.
- When you use *A1-03* [Initialize Parameters] to initialize the drive, the drive will not reset this parameter.

0 : English

1 : Japanese

2 : German

3 : French

4 : Italian

5 : Spanish

6 : Portuguese

7 : Chinese

8 : Czech

9 : Russian

10 : Turkish

11 : Polish

12 : Greek

■ A1-01: Access Level Selection

No. (Hex.)	Name	Description	Default (Range)
A1-01 (0101) RUN	Access Level Selection	V/f CL-V/f OLV CLV AOLV OLV/PM AOLV/PM CLV/PM EZOLV Sets user access to parameters. The access level controls which parameters the keypad will display, and which parameters the user can set.	2 (0 - 3)

0 : Operation Only

Access to *A1-00*, *A1-01*, *A1-04* [Password], and the *U* Monitors.

1 : User Parameters

Access to *A1-00*, *A1-01*, *A1-04*, and *A2-01* to *A2-32* [User Parameters 1 to 32].

2 : Advanced Level

Access to all parameters, but not Expert Mode parameters.

3 : Expert Level

Access to all parameters including Expert Mode parameters.

Table 12.1 shows which keypad screens are available for each *A1-01* settings.

Table 12.1 Access Level and Available Keypad Screens

Mode	Keypad Screen	A1-01 [Access Level Selection] Setting			
		0	1	2	3
Drive Mode	Monitors	Yes	Yes	Yes	Yes
Programming Mode	Parameters	Yes	Yes	Yes	Yes
	User Custom Parameters	No	Yes	Yes	Yes
	Parameter Backup/Restore	No	No	Yes	Yes
	Modified Parameters/Fault Log	No	No	Yes	Yes
	Auto-Tuning	No	No	Yes	Yes
	Initial Setup Screen	No	No	Yes	Yes
	Diagnostic Tools	No	No	Yes	Yes

Note:

- When you use A1-04 and A1-05 [Password Setting] to set a password, you cannot change the values set in A1-01 to A1-03, A1-06, A1-07, or A2-01 to A2-32.
- When H1-xx = 1B [MFDI Function Select = Program Lockout], you must activate the terminal to change parameter settings.
- When you use MEMOBUS/Modbus communications, you must send the Enter command from the controller to the drive and complete the serial communication write process before you can use the keypad to change parameter settings.

■ A1-02: Control Method Selection

No. (Hex.)	Name	Description	Default (Range)
A1-02 (0102)	Control Method Selection	V/f CL-V/f OLV CLV AOLV OLV/PM AOLV/PM CLV/PM EZOLV	2 (0 - 8)

Note:

When you change the control methods, the parameter values specified by A1-02 and E3-01 [Motor 2 Control Mode Selection] are changed to their default values.

0 : V/f Control

Use this control method in these applications and conditions:

- For general variable-speed control applications in which a high level of responsiveness or high-precision speed control is not necessary.
- Applications in which more than one motor are connected to one drive
- When there is not sufficient data to set the motor parameters
- When it is not possible to do Auto-Tuning. The speed control range is 1:40.

1 : V/f Control with Encoder

Use this control method in these applications and conditions:

- For general variable-speed control applications in which a high level of responsiveness or high-precision speed control is not necessary.
- When there is not sufficient data to set the motor parameters
- When it is not possible to do Auto-Tuning. The speed control range is 1:40.

2 : Open Loop Vector

Use this control method for general variable-speed control applications in which high-precision speed control is necessary. In this control method, a feedback signal from the motor is not necessary to have high torque response and high torque when you operate the drive at low speeds. The speed control range is 1:200.

3 : Closed Loop Vector

Use this control method for general variable-speed control applications in which these qualities are necessary:

- A high level of responsiveness
- High-precision speed control up to zero speed
- High-precision torque control. A speed feedback signal from the motor is necessary for this control method. The speed control range is 1:1500.

4 : Advanced Open Loop Vector

This is a control method for induction motors. Use this control method for applications in which high-precision speed control is necessary.

This control method has high speed and torque response and high torque when operating at low speeds. The speed control range is 1:200.

5 : PM Open Loop Vector

The drive controls an IPM motor or SPM motor in this control method. Use this control method for general variable-speed control applications in which a high level of responsiveness or high-precision speed control are not necessary. The speed control range is 1:20.

6 : PM Advanced Open Loop Vector

The drive can control an IPM motor in this control method. Use this control method for general variable-speed control applications in which high-precision speed control and torque limit are necessary. The speed control range is 1:20. The speed control range is 1:100 when $n8-57 = 1$ [*HFI Overlap Selection = Enabled*].

Note:

The speed control range 1:100 is the momentary operation area. Correctly select the drive and motor capacity for continuous operation.

7 : PM Closed Loop Vector

The drive controls a PM motor in this control method. Use this control method for constant torque applications in which high-precision control with a PM motor is necessary. Also use this control method for general variable-speed control applications in which high torque response and high-precision torque control are necessary. A speed feedback signal from the motor is necessary for this control method. The speed control range is 1:1500.

8 : EZ Vector Control

The drive controls induction motors and PM motors in this control method. This control method uses an easier procedure to operate motors with more efficiency. Use this control method for derating torque applications. For example, fans and pumps.

■ A1-03: Initialize Parameters

No. (Hex.)	Name	Description	Default (Range)
A1-03 (0103)	Initialize Parameters	 Sets parameters to default values.	0 (0 - 3330)

Note:

- After you initialize the drive, the drive automatically sets $A1-03 = 0$.
- User Parameters can save the parameter values for your application and use these values as default values for drive initialization.
- To use the 2 motor switchover function, first turn OFF the terminal to which $H1-xx = 16$ [*MFDI Function Selection = Motor 2 Selection*] is set, then change the $A1-03$ setting. An incorrect procedure will trigger $oPE08$ [*Parameter Selection Error*].

0 : No Initialization

1110 : User Initialization

Sets parameters to the values set by the user as user settings. Set $o2-03 = 1$ [*User Parameter Default Value = Set defaults*] to save the user settings.

You can save the parameter settings that were adjusted for the test run as user-set default values to the drive. Set $A1-03 = 1110$ to reset to the saved parameter settings.

Follow this procedure to save User Parameter setting values, and to do a User Initialization.

1. Set parameters correctly for the application.
2. Set $o2-03 = 1$ [*User Parameter Default Value = Set defaults*].
This saves parameter settings for a User Initialization.
The drive will then automatically set $o2-03 = 0$.
3. Set $A1-03 = 1110$ to reset to the saved parameter settings.
When you initialize the drive, the drive sets the parameter values to the User Parameter setting values.

2220 : 2-Wire Initialization

Sets MFDI terminal S1 to Forward Run and terminal S2 to Reverse Run, and resets all parameters to default settings.

3330 : 3-Wire Initialization

Sets MFDI terminal S1 to Run, terminal S2 to Stop, and terminal S5 to FWD/REV, and resets all parameters to default settings.

The drive will not initialize the parameters in [Table 12.2](#) when $A1-03 = 2220, 3330$.

Table 12.2 Parameters that are not Initialized Using a 2-Wire Sequence or a 3-Wire Sequence

No.	Name
A1-00	Language Selection
A1-02	Control Method Selection
A1-07	DriveWorksEZ Function Selection
E1-03	V/f Pattern Selection
E5-01	PM Motor Code Selection
E5-02	PM Motor Rated Power (kW)
E5-03	Motor Rated Current (FLA)
E5-04	PM Motor Pole Count
E5-05	PM Motor Resistance (ohms/phase)
E5-06	PM d-axis Inductance (mH/phase)
E5-07	PM q-axis Inductance (mH/phase)
E5-09	PM Back-EMF Vpeak (mV/(rad/s))
E5-11	Encoder Z-Pulse Offset
E5-24	PM Back-EMF L-L Vrms (mV/rpm)
E5-25	Polarity Estimation Timeout
F6-08	Comm Parameter Reset @Initialize
F6-xx/F7-xx	Communication Option Parameters Set F6-08 = 1 [Comm Parameter Reset @Initialize = Reset Back to Factory Default] to initialize communication option parameters.
L8-35	Installation Method Selection
o2-04	Drive Model (KVA) Selection
q1-xx - qx-xx	DriveWorksEZ Parameters
r1-xx	DWEZ Connection 1-20

Note:

- Set A1-06 [Application Preset] to let the drive automatically set the best parameter settings for the selected application. The drive does not initialize A1-02 when A1-03 = 2220, 3330.
- When A1-03 = 2220, 3330, the drive automatically set A1-05 [Password Setting] = 0000. Make sure that you set the password again for applications where a password is necessary.

■ **A1-04: Password**

No. (Hex.)	Name	Description	Default (Range)
A1-04 (0104)	Password	<div style="display: flex; justify-content: space-between; font-size: small;"> V/f CL-V/f OLV CLV AOLV OLV/PM AOLV/PM CLV/PM EZOLV </div> Entry point for the password set in A1-05 [Password Setting]. The user can view the settings of parameters that are locked without entering the password. Enter the correct password in this parameter to change parameter settings.	0000 (0000 - 9999)

If the password entered in A1-04 does not agree with the password setting in A1-05, you cannot change these parameters:

- A1-01 [Access Level Selection]
- A1-02 [Control Method Selection]
- A1-03 [Initialize Parameters]
- A1-06 [Application Preset]
- A1-07 [DriveWorksEZ Function Selection]
- A2-01 to A2-32 [User Parameter 1 to 32]















To lock parameter settings after making changes without changing the password, enter the incorrect password in A1-04 and push .

Enter the Password to Unlock Parameters

Use this procedure to unlock parameter settings.









Set the password in A1-05 [Password Setting], and show the Parameter Setting Mode screen on the keypad.

This procedure verifies the password, and makes sure that the parameter settings are unlocked.

1. Push  or  to select "A: Initialization Parameters", then push .
2. Push  or  to select [A1-04], then push .
You can now change parameter settings.
3. Push  or  to move the digit and enter the password.
4. Push  to confirm the password.
The drive unlocks the parameters and automatically shows the Parameters Screen.
5. Push  or  to show [A1-02], then push .
The keypad shows the setting value for [A1-02].
6. Push  or  to make sure that you can change the setting value.

Push  (Back) until the keypad shows the Parameter Setup Mode screen.



■ A1-05: Password Setting

No. (Hex.)	Name	Description	Default (Range)
A1-05 (0105)	Password Setting	         Set the password to lock parameters and prevent changes to parameter settings. Enter the correct password in A1-04 [Password] to unlock parameters and accept changes.	0000 (0000 - 9999)

This parameter can lock these parameter settings:









- A1-01 [Access Level Selection]
- A1-02 [Control Method Selection]
- A1-03 [Initialize Parameters]
- A1-06 [Application Preset]
- A1-07 [DriveWorksEZ Function Selection]
- A2-01 to A2-32 [User Parameter 1 to 32]

Note:

- Usually, the keypad will not show A1-05. To show and set A1-05, show A1-04 [Password] and then push  and  on the keypad at the same time.
- After you set A1-05, the keypad will not show it again until you enter the correct password in A1-04. Make sure that you remember the A1-05 setting value. If you do not know the A1-05 setting value, contact Yaskawa or your nearest sales representative.
- When A1-03 = 2220, 3330 [2-Wire Initialization, 3-Wire Initialization], the drive is initialized to A1-05 = 0000. Be sure to set the password again when a password is necessary for the application.
- Change the setting value in A1-05 to change the password. The new setting value becomes the new password.
- When you use the password to unlock and change a parameter, enter a value other than the password in A1-04 to lock the parameter again with the same password.
- If A1-04 ≠ A1-05, MEMOBUS Communication cannot read or write A1-05.

■ A1-06: Application Preset

WARNING! Sudden Movement Hazard. Check the I/O signals and the external sequences for the drive before you set the Application Preset function. When you set the Application Preset function (A1-06 ≠ 0), it changes the I/O terminal functions for the drive and it can cause equipment to operate unusually. This can cause serious injury or death.

No. (Hex.)	Name	Description	Default (Range)
A1-06 (0127)	Application Preset	         Sets the drive to operate in selected application conditions.	0 (0 - 7)

The drive software contains the application presets shown below. Set A1-06 to align with the application to let the drive automatically set the best parameter settings for the selected application. The drive saves parameters frequently used for the application in parameters A2-01 to A2-16 [User Parameters 1 to 16] for easy configuration and reference in [User Custom Parameters] in the main menu.

- Water supply pump
- Conveyor
- Exhaust fan
- HVAC fan

12.2 A: Initialization Parameters

- Air compressor
- Crane (hoist)
- Crane (traveling)

Note:

- Before you set *A1-06*, make sure that you set *A1-03* = 2220, 3330 [*Initialize Parameters* = 2-Wire Initialization, 3-Wire Initialization] to initialize parameters.
- After you set *A1-06* for a hoist application (*A1-06* = 6 or 7), make sure that you do Auto-Tuning.
- It is not possible to change the *A1-06* value. To set an application preset, first set *A1-03* = 2220 to initialize parameters, then set this parameter. If initializing all parameters will cause a problem, do not change the settings.
If you set *A2-33* = 1 [*User Parameter Auto Selection* = Enabled: Auto Save Recent Parm] to set parameters to *A2-17* to *A2-32* [*User Parameters 17 to 32*] automatically, the drive will reset these parameters when you change the *A1-06* setting.

0 : General-purpose

The drive saves the parameters in [Table 12.3](#) as user parameters.

Table 12.3 Parameters Saved as User Parameters with the General-purpose Preset

User Parameter No.	Parameter No. Saved	Name
A2-01	A1-02	Control Method Selection
A2-02	b1-01	Frequency Reference Selection 1
A2-03	b1-02	Run Command Selection 1
A2-04	b1-03	Stopping Method Selection
A2-05	C1-01	Acceleration Time 1
A2-06	C1-02	Deceleration Time 1
A2-07	C6-01	Normal / Heavy Duty Selection
A2-08	C6-02	Carrier Frequency Selection
A2-09	d1-01	Reference 1
A2-10	d1-02	Reference 2
A2-11	d1-03	Reference 3
A2-12	d1-04	Reference 4
A2-13	d1-17	Jog Reference
A2-14	E1-01	Input AC Supply Voltage
A2-15	E1-03	V/f Pattern Selection
A2-16	E1-04	Maximum Output Frequency
A2-17	E1-05	Maximum Output Voltage
A2-18	E1-06	Base Frequency
A2-19	E1-09	Minimum Output Frequency
A2-20	E1-13	Base Voltage
A2-21	E2-01	Motor Rated Current (FLA)
A2-22	E2-04	Motor Pole Count
A2-23	E2-11	Motor Rated Power
A2-24	H4-02	Terminal FM Analog Output Gain
A2-25	L1-01	Motor Overload (oL1) Protection
A2-26	L3-04	Stall Prevention during Decel

1 : Water Supply Pump 2

The drive automatically sets the parameters in [Table 12.4](#) for a water supply pump application.

Table 12.4 Best Parameter Settings for Water Supply Pump Applications

No.	Name	Optimal Value
A1-02	Control Method Selection	0: V/f Control
b1-04	Reverse Operation Selection	1: Reverse Disabled
C1-01	Acceleration Time 1	1.0 s
C1-02	Deceleration Time 1	1.0 s

No.	Name	Optimal Value
C6-01	Normal / Heavy Duty Selection	1: Normal Duty Rating
E1-03	V/f Pattern Selection	F: Custom
E1-07	Mid Point A Frequency	30.0 Hz
E1-08	Mid Point A Voltage	50.0 V
L2-01	Power Loss Ride Through Select	1: Enabled
L3-04	Stall Prevention during Decel	1: Enabled

The drive saves the parameters in [Table 12.5](#) as user parameters.

Table 12.5 Parameters Saved as User Parameters with the Water Supply Pump Preset

User Parameter No.	Parameter No. Saved	Name
A2-01	b1-01	Frequency Reference Selection 1
A2-02	b1-02	Run Command Selection 1
A2-03	b1-04	Reverse Operation Selection
A2-04	C1-01	Acceleration Time 1
A2-05	C1-02	Deceleration Time 1
A2-06	E1-03	V/f Pattern Selection
A2-07	E1-07	Mid Point A Frequency
A2-08	E1-08	Mid Point A Voltage
A2-09	E2-01	Motor Rated Current (FLA)
A2-10	H1-05	Terminal S5 Function Selection
A2-11	H1-06	Terminal S6 Function Selection
A2-12	H1-07	Terminal S7 Function Selection
A2-13	L5-01	Number of Auto-Restart Attempts

2 : Conveyor

The drive automatically sets the parameters in [Table 12.6](#) for a conveyor application.

Table 12.6 Best Parameter Settings for Conveyor Applications

No.	Name	Optimal Value
A1-02	Control Method Selection	0: V/f Control
C1-01	Acceleration Time 1	3.0 s
C1-02	Deceleration Time 1	3.0 s
C6-01	Normal / Heavy Duty Selection	0: Heavy Duty Rating
L3-04	Stall Prevention during Decel	1: Enabled

The drive saves the parameters in [Table 12.7](#) as user parameters.

Table 12.7 Parameters Saved as User Parameters with the Conveyor Preset

User Parameter No.	Parameter No. Saved	Name
A2-01	A1-02	Control Method Selection
A2-02	b1-01	Frequency Reference Selection 1
A2-03	b1-02	Run Command Selection 1
A2-04	C1-01	Acceleration Time 1
A2-05	C1-02	Deceleration Time 1
A2-06	E2-01	Motor Rated Current (FLA)
A2-07	L3-04	Stall Prevention during Decel

3 : Exhaust Fan

The drive automatically sets the parameters in [Table 12.8](#) for an exhaust fan application.

Table 12.8 Best Parameter Settings for Exhaust Fan Applications

No.	Name	Optimal Value
A1-02	Control Method Selection	0: V/f Control
b1-04	Reverse Operation Selection	1: Reverse Disabled
C6-01	Normal / Heavy Duty Selection	1: Normal Duty Rating
E1-03	V/f Pattern Selection	F: Custom
E1-07	Mid Point A Frequency	30.0 Hz
E1-08	Mid Point A Voltage	50.0 V
L2-01	Power Loss Ride Through Select	1: Enabled
L3-04	Stall Prevention during Decel	1: Enabled

The drive saves the parameters in [Table 12.9](#) as user parameters.

Table 12.9 Parameters Saved as User Parameters with the Exhaust Fan Preset

User Parameter No.	Parameter No. Saved	Name
A2-01	b1-01	Frequency Reference Selection 1
A2-02	b1-02	Run Command Selection 1
A2-03	b1-04	Reverse Operation Selection
A2-04	b3-01	Speed Search at Start Selection
A2-05	C1-01	Acceleration Time 1
A2-06	C1-02	Deceleration Time 1
A2-07	E1-03	V/f Pattern Selection
A2-08	E1-07	Mid Point A Frequency
A2-09	E1-08	Mid Point A Voltage
A2-10	E2-01	Motor Rated Current (FLA)
A2-11	H1-05	Terminal S5 Function Selection
A2-12	H1-06	Terminal S6 Function Selection
A2-13	H1-07	Terminal S7 Function Selection
A2-14	L5-01	Number of Auto-Restart Attempts

4 : HVAC Fan

The drive automatically sets the parameters in [Table 12.10](#) for an HVAC fan application.

Table 12.10 Best Parameter Settings for HVAC Applications

No.	Name	Optimal Value
A1-02	Control Method Selection	0: V/f Control
b1-04	Reverse Operation Selection	1: Reverse Disabled
b1-17	Run Command at Power Up	1: Accept Existing RUN Command
C6-01	Normal / Heavy Duty Selection	1: Normal Duty Rating
C6-02	Carrier Frequency Selection	3: 8.0 kHz
H2-03	Terminal M5-M6 Function Selection	39: Watt Hour Pulse Output
L2-01	Power Loss Ride Through Select	2: Enabled while CPU Power Active
L8-03	Overheat Pre-Alarm Selection	4: Operate at Reduced Speed (L8-19)
L8-38	Carrier Frequency Reduction	2: Enabled for All Speeds

The drive saves the parameters in [Table 12.11](#) as user parameters.

Table 12.11 Parameters Saved as User Parameters with the HVAC Preset

User Parameter No.	Parameter No. Saved	Name
A2-01	b1-01	Frequency Reference Selection 1
A2-02	b1-02	Run Command Selection 1
A2-03	b1-03	Stopping Method Selection

User Parameter No.	Parameter No. Saved	Name
A2-04	b1-04	Reverse Operation Selection
A2-05	C1-01	Acceleration Time 1
A2-06	C1-02	Deceleration Time 1
A2-07	C6-02	Carrier Frequency Selection
A2-08	d2-01	Frequency Reference Upper Limit
A2-09	d2-02	Frequency Reference Lower Limit
A2-10	E1-03	V/f Pattern Selection
A2-11	E1-04	Maximum Output Frequency
A2-12	E2-01	Motor Rated Current (FLA)
A2-13	H3-11	Terminal A2 Gain Setting
A2-14	H3-12	Terminal A2 Bias Setting
A2-15	L2-01	Power Loss Ride Through Select
A2-16	o4-12	kWh Monitor Initialization

5 : Air Compressor

The drive automatically sets the parameters in [Table 12.12](#) for an air compressor application.

Table 12.12 Best Parameter Settings for Air Compressor Applications

No.	Name	Optimal Value
A1-02	Control Method Selection	0: V/f Control
b1-04	Reverse Operation Selection	1: Reverse Disabled
C1-01	Acceleration Time 1	5.0 s
C1-02	Deceleration Time 1	5.0 s
C6-01	Normal / Heavy Duty Selection	0: Heavy Duty Rating
E1-03	V/f Pattern Selection	F: Custom
L2-01	Power Loss Ride Through Select	1: Enabled
L3-04	Stall Prevention during Decel	1: Enabled

The drive saves the parameters in [Table 12.13](#) as user parameters.

Table 12.13 Parameters Saved as User Parameters with the Air Compressor Preset

User Parameter No.	Parameter No. Saved	Name
A2-01	b1-01	Frequency Reference Selection 1
A2-02	b1-02	Run Command Selection 1
A2-03	b1-04	Reverse Operation Selection
A2-04	C1-01	Acceleration Time 1
A2-05	C1-02	Deceleration Time 1
A2-06	E1-03	V/f Pattern Selection
A2-07	E1-07	Mid Point A Frequency
A2-08	E1-08	Mid Point A Voltage
A2-09	E2-01	Motor Rated Current (FLA)

6 : Crane (Hoist)

The drive automatically sets the parameters in [Table 12.14](#) for a hoist application.

Note:

Make sure that you do Auto-Tuning after you set *A1-06* for a hoist application. Refer to [Notes for Elevator or Lift Applications on page 669](#) for hoist (elevator) instructions.

Table 12.14 Best Parameter Settings for Hoist Applications

No.	Name	Optimal Value
A1-02	Control Method Selection	2: Open Loop Vector
b1-01	Frequency Reference Selection 1	0: Keypad
b6-01	Dwell Reference at Start	3.0 Hz
b6-02	Dwell Time at Start	0.3 s
C1-01	Acceleration Time 1	3.0 s
C1-02	Deceleration Time 1	3.0 s
C6-01	Normal / Heavy Duty Selection	0: Heavy Duty Rating
C6-02	Carrier Frequency Selection	2: 5 kHz
d1-01	Reference 1	6.00 Hz
d1-02	Reference 2	30.00 Hz
d1-03	Reference 3	50.00 Hz
E1-03	V/f Pattern Selection	F: Custom
H2-01	Terminal M1-M2 Function Selection	5: Frequency Detection 2
H2-02	Terminal M3-M4 Function Selection	37: During Frequency Output
H3-06	Terminal A3 Function Selection	F: Not Used
L2-03	Minimum Baseblock Time	0.3 s
L3-04	Stall Prevention during Decel	0: Disabled
L4-01	Speed Agree Detection Level	2.0 Hz
L4-02	Speed Agree Detection Width	0.0 Hz
L6-01	Torque Detection Selection 1	8: UL @ RUN - Fault
L6-02	Torque Detection Level 1	2%
L6-03	Torque Detection Time 1	0.5 s
L8-05	Input Phase Loss Protection Sel	1: Enabled
L8-07	Output Phase Loss Protection Sel	1: Fault when one phase is lost
L8-38	Carrier Frequency Reduction	1: Enabled below 6 Hz
L8-41	High Current Alarm Selection	1: Enabled

The drive saves the parameters in [Table 12.15](#) as user parameters.

Table 12.15 Parameters Saved as User Parameters with the Hoist Preset

User Parameter No.	Parameter No. Saved	Name
A2-01	A1-02	Control Method Selection
A2-02	b1-01	Frequency Reference Selection 1
A2-03	b6-01	Dwell Reference at Start
A2-04	b6-02	Dwell Time at Start
A2-05	C1-01	Acceleration Time 1
A2-06	C1-02	Deceleration Time 1
A2-07	C6-02	Carrier Frequency Selection
A2-08	d1-01	Reference 1
A2-09	d1-02	Reference 2
A2-10	d1-03	Reference 3
A2-11	E1-08	Mid Point A Voltage
A2-12	H2-01	Terminal M1-M2 Function Selection
A2-13	L1-01	Motor Overload (oL1) Protection
A2-14	L4-01	Speed Agree Detection Level
A2-15	L6-02	Torque Detection Level 1
A2-16	L6-03	Torque Detection Time 1

7 : Crane (Traveling)

The drive automatically sets the parameters in [Table 12.16](#) for a traveling application.

Table 12.16 Optimal Settings for Traveling Applications

No.	Name	Optimal Value
A1-02	Control method selection	0: V/f Control
b1-01	Frequency Reference Selection 1	0: Keypad
C1-01	Acceleration Time 1	3.0 s
C1-02	Deceleration Time 1	3.0 s
C6-01	Normal / Heavy Duty Selection	0: Heavy Duty Rating
C6-02	Carrier Frequency Selection	2: 5 kHz
d1-01	Reference 1	6.00 Hz
d1-02	Reference 2	30.00 Hz
d1-03	Reference 3	50.00 Hz
H1-05	Terminal S5 Function Selection	3: Multi-Step Speed Reference 1
H1-06	Terminal S6 Function Selection	4: Multi-Step Speed Reference 2
H2-01	Terminal M1-M2 Function Selection	37: During Frequency Output
H2-02	Terminal M3-M4 Function Selection	37: During Frequency Output
H3-06	Terminal A3 Function Selection	1F: Not Used
L3-04	Stall Prevention during Decel	0: Disabled
L8-05	Input Phase Loss Protection Sel	1: Enabled
L8-07	Output Phase Loss Protection Sel	1: Fault when one phase is lost
L8-38	Carrier Frequency Reduction	1: Enabled below 6 Hz
L8-41	High Current Alarm Selection	1: Enabled

The drive saves the parameters in [Table 12.17](#) as user parameters.

Table 12.17 Parameters Saved as User Parameters with the Traveling Preset

User Parameter No.	Parameter No. Saved	Name
A2-01	b1-01	Frequency Reference Selection 1
A2-02	C1-01	Acceleration Time 1
A2-03	C1-02	Deceleration Time 1
A2-04	C6-02	Carrier Frequency Selection
A2-05	d1-01	Reference 1
A2-06	d1-02	Reference 2
A2-07	d1-03	Reference 3
A2-08	E2-01	Motor Rated Current (FLA)
A2-09	H1-05	Terminal S5 Function Selection
A2-10	H1-06	Terminal S6 Function Selection
A2-11	H2-01	Terminal M1-M2 Function Selection
A2-12	L1-01	Motor Overload (oL1) Protection

■ Notes for Elevator or Lift Applications

When you use the drive for elevator or lift applications, read the safety descriptions and precautions, and safely and correctly use the device.

Conditions to Open and Close the Brake

Set *L4-07* = 0 [*Speed Agree Detection Selection = No Detection during Baseblock*] to open and close the holding brake.

When *L4-07* = 1 [*Detection Always Enabled*], the output frequency increases when you input the Run command although the external baseblock command is input. Because of this, speed detection operates and will open the brake signal.

• Set Related Parameters

Table 12.18 shows examples of parameter settings to use the MFDO terminal (M1-M2) as the holding brake open and close signal.

Table 12.18 Holding Brake Open and Close Signal Setting Example

Brake Open and Close Signal		Brake Open and Close Level Adjust		Applicable Control Methods (A1-02 Setting Value)				
Signal Name	Parameter Settings	Signal Name	Parameter Settings	V/f (0)	OLV (2)	CLV (3)	AOLV (4)	CLV/PM (7) *1
Frequency (FOUT) Detection 2	L4-07 = 0	Speed Agree Detection Level	L4-01 = 1.0 Hz to 3.0 Hz *2	x	x	-	x	-
	H2-01 = 5	Speed Agree Detection Width	L4-02 = 0.0 Hz to 0.5 Hz *3					
During Frequency Output	H2-01 = 37	DC Injection/Zero Speed Threshold	b2-01 = 0.1 Hz to 0.5 Hz	-	-	x	-	x

- *1 When A1-02 = 7 [PM Closed Loop Vector], make sure that the motor can rotate before you do Auto-Tuning or switch the encoder. Refer to Closed Loop Vector Control for induction motors for information about the signal to use and the adjustment method.
- *2 When A1-02 = 2 [Open Loop Vector], it is the usual setting range. When A1-02 = 0 [V/f Control], set L4-01 to the rated slip frequency of the motor + approximately 0.5 Hz. If you set the value too low, motor torque will not be sufficient and it will cause motor rollback. Set the parameters to meet these conditions at the same time. If the setting is too high, overshoot is possible at start.
 - L4-01 > E1-09 [Minimum Output Frequency]
 - L4-01 > L4-02 [Speed Agree Detection Width]
- *3 Use L4-02 to adjust the detection width of Frequency Detection 2. If rollback occurs when the motor is stopped, set the frequency to approximately 0.1 Hz.

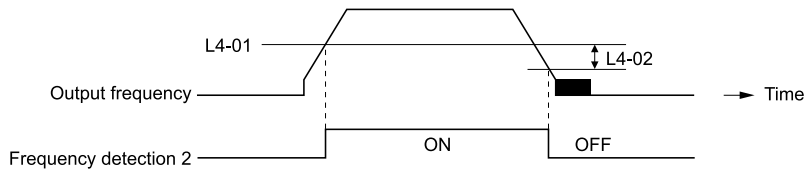

Figure 12.1 Frequency Detection 2

Sequence Circuit Configuration

Use these conditions to set the circuit for the open/close sequence of the holding brake:

- Set the sequence-side operation conditions to activate terminal M1-M2 and open the holding brake.
- Set the sequence to close the holding brake in an emergency if the drive detects a fault.
- Set the sequence to open the holding brake when you enter an increase or decrease command.

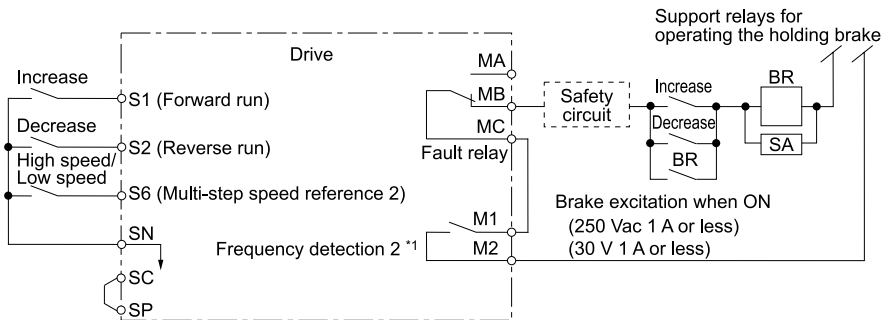

Figure 12.2 Sequence Circuit Configuration Diagram

*1 L4-07 = 0 [Speed Agree Detection Selection = No Detection during Baseblock] or During Frequency Output

Time Chart

Figure 12.3 shows the open/close sequence of the holding brake.

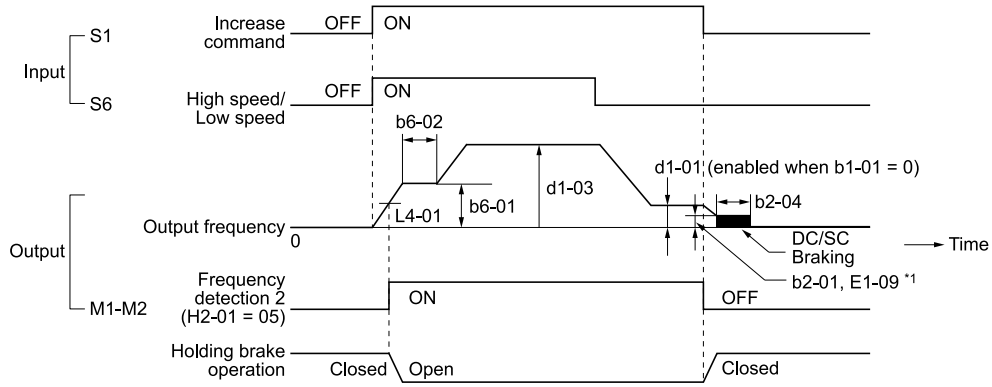

Figure 12.3 Holding Brake Open and Close Sequence Time Chart (V/f, CL-V/f, OLV)

*1 Start braking from the higher set frequency between *b2-01* [DC Injection/Zero SpeedThreshold] or *E1-09* [Minimum Output Frequency].

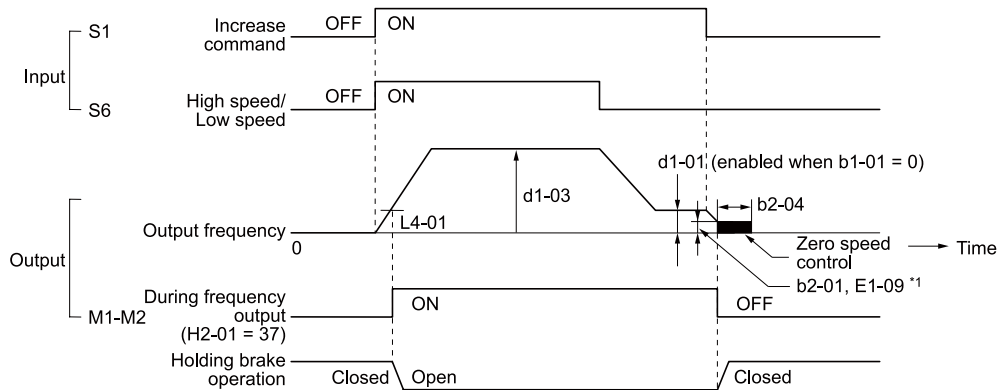

Figure 12.4 Holding Brake Open and Close Sequence Time Chart (CLV, CLV/PM)

*1 Start braking from the higher set frequency between *b2-01* [DC Injection/Zero SpeedThreshold] or *E1-09* [Minimum Output Frequency].

Notes on when Using Other Functions

Function	Precautions
Stall Prevention during Deceleration	<p>When you connect a braking resistor to discharge the regenerative power to the drive, set <i>L3-04</i> = 0 [Stall Prevention during Decel = Disabled].</p> <p>Note: If <i>L3-04</i> = 1 [General Purpose], it is possible that the drive will not stop in the set deceleration time. Do not change the default settings of these related parameters: • <i>L3-01</i> = 1 [Stall Prevention during Accel = Enabled] • <i>L3-05</i> = 1 [Stall Prevention during RUN = Deceleration Time 1 (C1-02)]</p>
Auto-Tuning for Induction Motors	<ul style="list-style-type: none"> • When <i>A1-02</i> = 2, 3, 4 [Control Method Selection = Open Loop Vector, Closed Loop Vector, Advanced Open Loop Vector], Auto-Tune the motor before you operate the drive. • Disconnect the drive from the motor to do Rotational Auto-Tuning. • Auto-Tuning runs automatically for approximately 1 minute. Do not do Auto-Tuning with the motor engaged in the elevator system. <p>Note:</p> <ul style="list-style-type: none"> • If you cannot disconnect the motor from the machine, do Stationary Auto-Tuning. During this time, the drive automatically measures the necessary motor data. If the motor test report or the motor nameplate is not available, use Stationary Auto-Tuning. Do Stationary Auto-Tuning for Line-to-Line Resistance for better torque characteristics at low speeds in the V/f Control mode. • When you do Stationary Auto-Tuning, the drive energizes the motor and the motor stays stopped. • To Auto-Tune a specialized motor, for example a wound motor, prepare a motor test report before Auto-Tuning and make sure that the motor parameter <i>E2-xx</i> is not too different than the value in the test report.

12.2 A: Initialization Parameters

Function	Precautions
Auto-Tuning for PM Motors	<p>You must set the motor data in the drive to run a PM motor.</p> <ul style="list-style-type: none"> When you use a PM motor recommended by Yaskawa Input the motor code in <i>E5-01</i>. <i>E5</i> and other related motor parameters will be automatically set to the optimal values. When you use a non-Yaskawa PM motor Do Auto-Tuning. <ul style="list-style-type: none"> When the motor nameplate or motor test report is available, enter the PM motor parameters directly with PM Motor Parameter Settings. If the motor nameplate or motor test report is not available, and the motor cannot rotate, do PM Stationary Auto-Tuning. If the motor nameplate or motor test report is not available, and the motor can rotate, do PM Rotational Auto-Tuning. When you replace an encoder, make sure that the motor can rotate and do Z Pulse Offset Tuning or PM Rotational Auto-Tuning. <p>Note:</p> <ul style="list-style-type: none"> Use in Closed Loop Vector Control for PM control method. When you do Auto-Tuning or replace the encoder, make sure that the motor can rotate. Set the Encoder Z-Pulse Offset. Refer to Closed Loop Vector Control for induction motors for information about the signal to use and the adjustment method.
Braking Resistor Overheat Protection	<p>When you use a braking resistor other than the optional Yaskawa braking resistor unit (LKEB-series), this function uses the thermal overload relay to detect braking resistor overheat. Load a sequence program that cuts the drive input power supply when the braking resistor overheats. ^{*1}</p>
Continuous Operation	<p>Do not use the momentary power loss continuous operation function and the Auto Restart function. If you use these functions, there is a risk that the motor will coast to a stop if the brake is open when there is a momentary power loss and the drive is operating or if there is a fault.</p> <p>Set the these parameters:</p> <ul style="list-style-type: none"> <i>L2-01</i> = 0 [<i>Power Loss Ride Through Select = Disabled</i>] <i>L5-01</i> = 0 [<i>Number of Auto-Restart Attempts = 0</i>]
Torque Limit	<p>The motor rated torque sets the value for <i>L7-01</i> to <i>L7-04</i> [<i>Torque Limit</i>]. If there will not be sufficient torque during start up, replace the drive with a larger capacity drive and set the torque limit between 200% and 300%. The <i>L7-01</i> to <i>L7-04</i> default setting is 200%.</p>
Input/Output Phase Loss Protection, Overtorque Detection	<p>To stop a fall because of phase loss, set these parameters:</p> <ul style="list-style-type: none"> <i>L8-05</i> = 1 [<i>Input Phase Loss Protection Sel = Enabled</i>] <i>L8-07</i> = 1 [<i>Output Phase Loss Protection Sel = Fault when One Phase is Lost</i>] <i>L6-01</i>, <i>L6-04</i> = 1 to 8 [<i>Torque Detection Selection 1/2 = oL @ Speed Agree - Alarm only to UL @ RUN - Fault</i>] <i>L6-02</i>, <i>L6-05</i> [<i>Torque Detection Level 1/2</i>] <i>L6-03</i>, <i>L6-06</i> [<i>Torque Detection Time 1/2</i>] <p>Note:</p> <p>Use precautions, for example fall detection, on the machine side.</p>
External Baseblock Command	<ul style="list-style-type: none"> If you enter the external baseblock signal set in <i>H1-01</i> to <i>H1-08</i> = 8 or 9 [<i>Terminal S1 to S8 Function Selection = Baseblock Command</i>] during run, the motor immediately coasts to stop. When you enter a baseblock command while the motor is operating, make sure that it is necessary. When you use an external baseblock command for the fast stop and operation start up interlocks, load the sequence to lock the holding brake when you enter the external baseblock command. If you enter the external baseblock command and then immediately remove it, the drive will not output the voltage in the time set in <i>L2-03</i> [<i>Minimum Baseblock Time</i>]. Do not use an external baseblock command for applications that have frequent Run/Stop commands.
Acceleration and Deceleration Times	<p>If you set the acceleration and deceleration times for the drive side too short and you do not add the mechanical operation delay time of the holding brake, the holding brake could operate late, or there could be overcurrent at start up, the brake could grind, or the motor could roll back when it stops. In these conditions, use Dwell Reference at Start/Time and DC Injection Braking at Stop to adjust the holding brake timing.</p>
Electromagnetic Contactor on the Drive Output Side	<p>Usually you must not install the electromagnetic contactor between the drive and motor. When you must install an electromagnetic contactor to use one drive to switchover more than one motor, follow these precautions:</p> <ul style="list-style-type: none"> Load a sequence that opens and closes the electromagnetic contactor when these two conditions are satisfied at the same time, unless there is an emergency: <ul style="list-style-type: none"> The holding brake is fully closed The drive terminals set for <i>H2-xx</i> = 8 or 1B [<i>MFDO Function Selection = During Baseblock</i>] are activated If you open and close the electromagnetic contactor during motor control or during DC Injection Braking (or zero speed control), the surge voltage and the motor direct input current can cause the drive to detect faults. When you use an electromagnetic contactor between the drive and motor, set <i>L8-07</i> = 1 or 2 [<i>Output Phase Loss Protection Sel = Fault when One Phase is Lost, Fault when Two Phases are Lost</i>].

*1 Refer to page [Standard Connection Diagram on page 66](#) when you load the sequence circuit.

Adjustments Relating to Control

When there is oscillation, rollback, or other control problems, adjust the parameters as specified by the control method.

[V/f Control and Closed Loop V/f Control on page 672](#) shows only the frequently adjusted parameters.

Note:

Torque and speed response for high-resistance and high-slip motors are slow. Adjust the torque and speed response to increase them. Low impedance (low-slip) motors will hunt and oscillate. Adjust the torque and speed response to increase them.

V/f Control and Closed Loop V/f Control

While in V/f Control, do not use *C3-01* [*Slip Compensation Gain*].

When you set the drive to CL-V/f Control, use the default settings for C5-01 to C5-05 [ASR Parameters]. If you make significant changes to the default settings, it can cause oscillation.

Table 12.19 Adjustment of Drive Control (V/f Control and Closed Loop V/f Control Methods)

Adjustment description	Parameter Number	Possible Solutions	Default	Recommended Setting
<ul style="list-style-type: none"> Prevent hunting and oscillation at middle speed range (10 Hz to 40 Hz) 	n1-02 [Hunting Prevention Gain Setting]	<ul style="list-style-type: none"> If the torque is not sufficient with heavy loads, decrease the setting. If there is hunting or oscillation with light loads, increase the setting. 	1.00	0.50 - 2.00
<ul style="list-style-type: none"> Prevent hunting or oscillation at high speed range (120 Hz or more) 	C4-25 [High-Speed Voltage Compensation]	Adjust the setting value.	1 [Enabled]	0 [Disabled]
<ul style="list-style-type: none"> Increasing motor excitation sound Prevent hunting or oscillation at low speed range and middle speed range 	C6-02 [Carrier Frequency Selection]	<ul style="list-style-type: none"> If there is a loud motor excitation sound, increase the setting value. If there is hunting or oscillation at low speed range or middle speed range, decrease the setting value. 	*1	1 - F
<ul style="list-style-type: none"> Increase torque at low speed range (10 Hz or lower) Prevent hunting and oscillation 	C4-01 [Torque Compensation Gain]	<ul style="list-style-type: none"> If the torque is not sufficient at low speed range, increase the setting value. If there is hunting or oscillation with light loads, decrease the setting value. 	1.00	0.50 - 1.50
<ul style="list-style-type: none"> Increase torque at low speed range Prevent shock during start up 	E1-08 [Mid Point A Voltage]	<ul style="list-style-type: none"> If the torque is not sufficient at low speed range, increase the setting value. If there is a large shock during start up, decrease the setting value. 	15.0 V *2 *3	13.0 V to 16.0 V *3
	E1-10 [Minimum Output Voltage]		9.0 V *2 *3	7.0 V to 10.0 V *3

*1 The default setting changes when the settings for C6-01 [Normal / Heavy Duty Selection] and o2-04 [Drive Model (KVA) Selection] change.

*2 The default setting changes when the settings for A1-02 [Control Method Selection] and E1-03 [V/f Pattern Selection] change.

*3 This is the value for 200 V class drives. Multiply the voltage by 2 for 400 V class drives.

Open Loop Vector Control Method

Do not adjust parameter C4-01 [Torque Compensation Gain]. Keep this parameter at its default setting.

If you cannot get speed accuracy during regeneration, set C3-04 = 1 [Slip Compensation at Regen = Enabled Above 6Hz]. If you cannot get speed accuracy at high speeds, set C3-05 = 1 [Output Voltage Limit Selection = Enabled].

Table 12.20 Adjustment of Drive Control (Open Loop Vector Control Method)

Adjustment description	Parameter Number	Possible Solutions	Default	Recommended Setting
<ul style="list-style-type: none"> Torque, increase speed response Prevent hunting and oscillation at middle speed range (10 Hz to 40 Hz) 	n2-01 [Automatic Freq Regulator Gain]	<ul style="list-style-type: none"> If torque and speed response are slow, decrease the setting value. If there is hunting or oscillation, increase the setting value. 	1.00	0.50 - 2.00
<ul style="list-style-type: none"> Prevent hunting or oscillation at high speed range (120 Hz or more) 	C4-25 [High-Speed Voltage Compensation]	Adjust the setting value.	1 [Enabled]	0 [Disabled]
<ul style="list-style-type: none"> Torque, increase speed response Prevent hunting and oscillation 	C4-02 [Torque Compensation Delay Time] *1	<ul style="list-style-type: none"> If torque and speed response are slow, decrease the setting value. If there is hunting or oscillation, increase the setting value. 	20 ms	20 ms to 100 ms
<ul style="list-style-type: none"> Increase speed response Increase speed stability 	C3-02 [Slip Compensation Delay Time]	<ul style="list-style-type: none"> When speed response is slow, decrease the setting value. If speed is not stable, increase the setting value. 	200 ms	100 ms to 500 ms
<ul style="list-style-type: none"> Improve speed accuracy 	C3-01 [Slip Compensation Gain]	<ul style="list-style-type: none"> If speed is too slow, increase the setting value. If speed is too fast, decrease the setting value. 	1.0	0.5 - 1.5
<ul style="list-style-type: none"> Increasing motor excitation sound Prevent hunting and oscillation at low speed range (10 Hz to or lower) 	C6-02 [Carrier Frequency Selection]	<ul style="list-style-type: none"> If there is a loud motor excitation sound, increase the setting value. If there is hunting or oscillation at low speed range, decrease the setting value. 	*2	1 - F

12.2 A: Initialization Parameters

Adjustment description	Parameter Number	Possible Solutions	Default	Recommended Setting
<ul style="list-style-type: none"> Increase torque and speed response at low speed range Prevent shock during start up 	E1-08 [Mid Point A Voltage]	<ul style="list-style-type: none"> If the torque and speed response are slow, increase the setting value. 	11.0 V *3	12.0 V to 13.0 V *3
	E1-10 [Minimum Output Voltage]	<ul style="list-style-type: none"> If there is a large shock during start up, decrease the setting value. 	2.0 V *3	2.0 V to 3.0 V *3

*1 If the value for C4-02 [Torque Compensation Delay Time] is high, the current can increase during start up. Adjust and check the current during start up.

*2 The default setting changes when the settings for C6-01 [Normal / Heavy Duty Selection] and o2-04 [Drive Model (KVA) Selection] change.

*3 This is the value for 200 V class drives. Multiply the voltage by 2 for 400 V class drives.

Closed Loop Vector Control Method

Table 12.21 Adjustment of Drive Control (Closed Loop Vector Control Method)

Adjustment description	Parameter Number	Possible Solutions	Default	Recommended Setting
<ul style="list-style-type: none"> Torque, increase speed response Prevent hunting and oscillation 	C5-01 [ASR Proportional Gain 1]	<ul style="list-style-type: none"> If the torque and speed response are slow, increase the setting value. If there is hunting or oscillation, decrease the setting value. 	20.00	10.00 - 50.00
	C5-03 [ASR Proportional Gain 2]			
<ul style="list-style-type: none"> Prevent hunting or oscillation at high speed range (120 Hz or more) 	C4-25 [High-Speed Voltage Compensation]	Adjust the setting value.	1 [Enabled]	0 [Disabled]
<ul style="list-style-type: none"> Torque, increase speed response Prevent hunting and oscillation 	C5-02 [ASR Integral Time 1]	<ul style="list-style-type: none"> If torque and speed response are slow, decrease the setting value. If there is hunting or oscillation, increase the setting value. 	0.500 s	0.300 s to 1.000 s
	C5-04 [ASR Integral Time 2]			
Change the ASR proportional gain and ASR integral time in accordance with the output frequency.	C5-07 [ASR Gain Switchover Frequency]	If you cannot get ASR proportional gain or integral time for low speed range or high speed range, switch as specified by the output frequency.	0.0 Hz (Do not switch)	0.0 Hz to maximum output frequency
<ul style="list-style-type: none"> Prevent hunting and oscillation 	C5-06 [ASR Delay Time]	<ul style="list-style-type: none"> If there is unsatisfactory machine rigidity and oscillation is possible, increase the setting value. 	0.004 s	0.004 s to 0.020 s

Elevator Start/Stop and Accel/Decel Time Shock Reduction

Shock when you start and stop the elevator and when you accelerate and decelerate is an issue for passenger elevator applications. If shock has an effect on the quality of the ride, adjust these parameters:

S-Curve Characteristics, Accel & Decel Time

Adjustment Parameter	Name
C1-01, C1-03, C1-05, C1-07	Acceleration Time 1 to 4
C1-02, C1-04, C1-06, C1-08	Deceleration Time 1 to 4
C2-01	S-Curve Time @ Start of Accel
C2-02	S-Curve Time @ End of Accel
C2-03	S-Curve Time @ Start of Decel
C2-04	S-Curve Time @ End of Decel

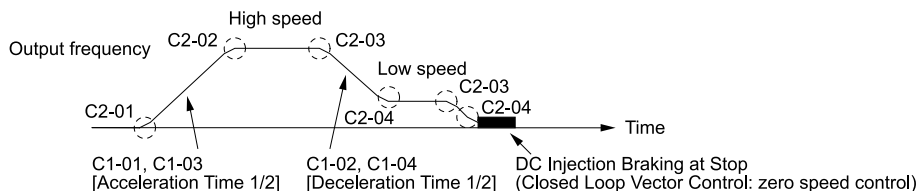

Figure 12.5 S-curve Characteristics, Accel & Decel Time

Note:

- When decreased operation times are necessary for the application, for example with cranes and hoists, do not use S-curve characteristic times.
- The default setting for *C2-04 [S-Curve Time @ End of Decel]* will be 0.00 seconds. The default setting for other S-curve characteristics will be 0.20 seconds. Set the acceleration/deceleration times and S-curve characteristic time correctly for acceleration/deceleration start up and end. The recommended setting of the S-curve characteristics time is 0.2 to 1.0 seconds.
- When you use the *C1-11 [Accel/Decel Time Switchover Freq]*, you can switch the acceleration/deceleration rate automatically during acceleration/deceleration. The default setting is disabled.
 When the Output Frequency $\geq C1-11$, operate at the acceleration and deceleration times set in *C1-01* and *C1-02*
 When the Output Frequency $< C1-11$, operate at the acceleration and deceleration times set in *C1-07* and *C1-08*
- During low speed operation, if the Output Frequency $< E1-09$ [*Minimum Output Frequency*] in the S-Curve Time @ Start of Decel, the drive will cancel the S-curve characteristics and will do DC Inject Braking at Stop (zero speed control).

Dwell Function at Start

Adjustment Parameter	Name
b6-01	Dwell Reference at Start
b6-02	Dwell Time at Start
H2-xx = 5	Frequency Detection 2

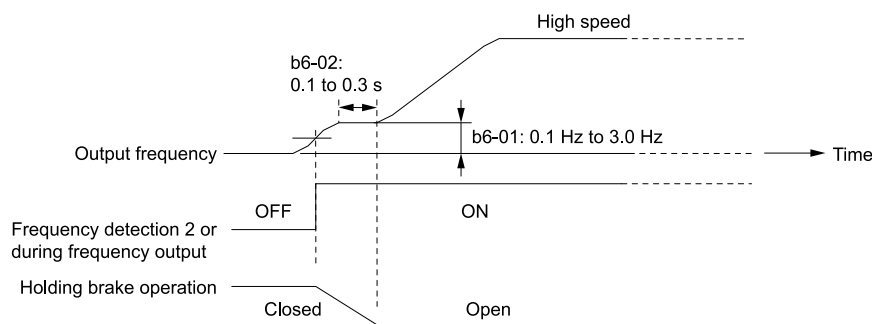

Figure 12.6 Dwell Function at Start

Note:

- If the mechanical operation of the holding brake is slow, use the Dwell Function at Start to prevent brake grinding (friction). Accelerate after the brake is fully open.
- When you use V/f Control and Open Loop Vector Control modes, set *b6-01 [Dwell Reference at Start]* $>$ *Frequency Detection 2 (brake open frequency)*.
- If the motor torque is not sufficient during start up, use the DC Inject Braking function to secure the motor current (torque) before you start the motor.
 –*b2-02 [DC Injection Braking Current]* recommended setting: 50% to 80% (V/f Control or Open Loop Vector Control)
 –*b2-03 [DC Inject Braking Time at Start]* recommended setting: 0.2 s to 0.5 s

DC Injection Braking at Stop, Zero Speed Control Function

Note:

If you disconnect a drive when it is controlling the motor or during DC Injection Braking (Zero speed level), a voltage surge can trigger a fault. When you use an electromagnetic contactor between the drive and motor, set *L8-07 = 1 or 2 [Output Phase Loss Protection Sel = Fault when one phase is lost, Fault when two phases are lost]*. If it necessary to disconnect the motor and drive when you stop the elevator, fully close the holding brake and disconnect the drive during baseblock (that is, while the baseblock signal is ON). This does not apply for emergency conditions.

Adjustment Parameter	Name
b2-01	DC Injection/Zero SpeedThreshold
b2-02	DC Injection Braking Current
b2-04	DC Inject Braking Time at Stop
H2-xx = 5	Frequency Detection 2

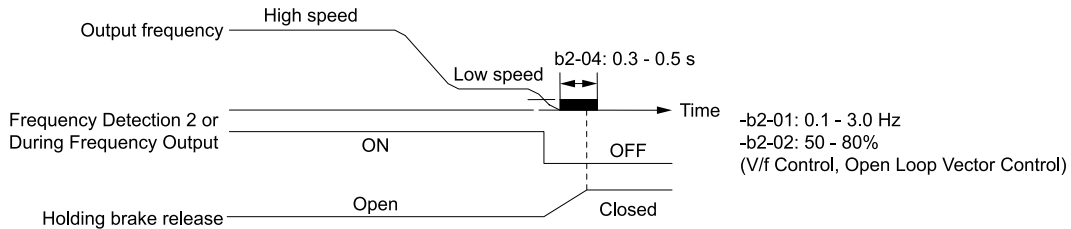

Figure 12.7 DC Injection Braking at Stop, Zero Speed Control Function

Note:

- If the mechanical operation of the holding brake is slow, use DC Injection Braking (zero speed control when set to closed loop vector) until the brake is fully closed to prevent rollback.
- If you cannot hold the load with DC Injection Braking when it is stopped in V/f Control and Open Loop Vector Control modes, use Dwell Function at Stop.
 - b6-03 [Dwell Reference at Stop]: Minimum output frequency to 3.0 Hz
 - When Frequency Detection 2 is OFF, it is less than L4-01 [Speed Agree Detection Level] - L4-02 [Speed Agree Detection Width].
 - b6-04 [Dwell Time at Stop] recommended setting: 0.3 s to 0.5 s
 - b2-04 [DC Inject Braking Time at Stop] recommended setting: 0.0 s

Torque Compensation (Torque Bias)

This function enters the torque compensation (torque bias) signal that matches a set load from the MFAI terminal in Closed Loop Vector Control to decrease the overshoot when you open and close the brake. You must detect the load and motoring/regeneration on the machine side before you use the function. If there is a polarity error, shock can increase.

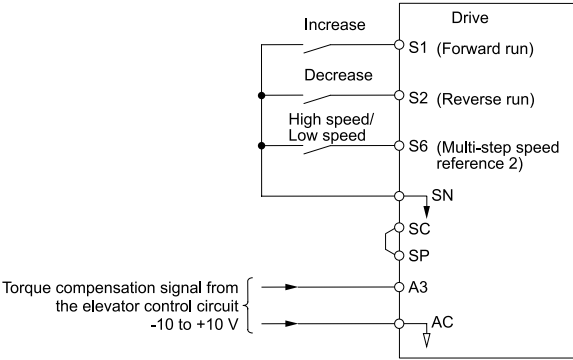
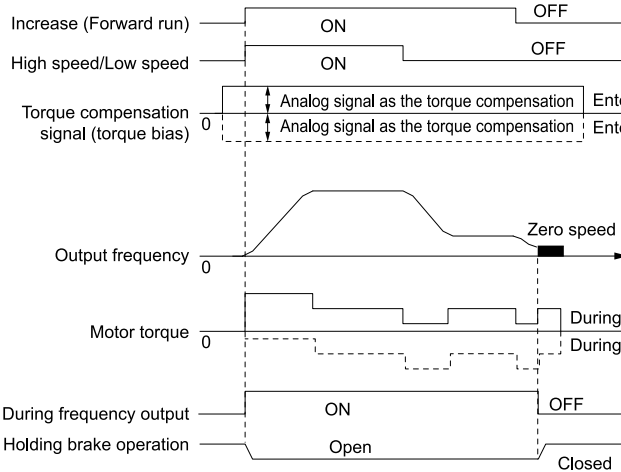
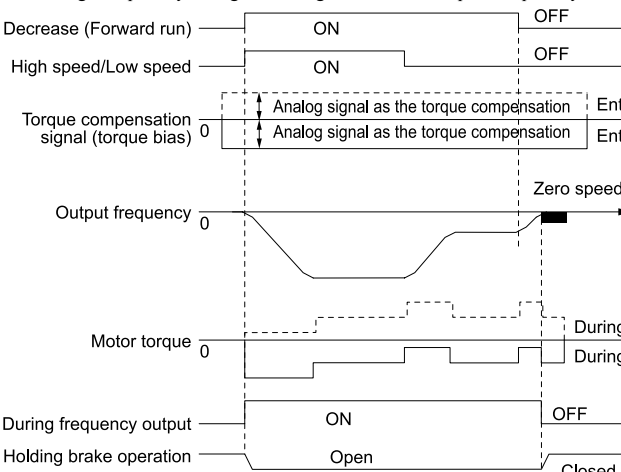
Item	Description
Sequence Circuit Configuration	 <p>H3-05 (Terminal A3 Signal Level Select) = 1 (-10 to +10 V) H3-06 (Terminal A3 Function Selection) = 14 [Torque Compensation (Torque Bias)] Fine tune by H3-07 and H3-08</p>
Time chart: Increase	<p>Enter the analog signal as the torque compensation (torque bias) signal as specified by the load quantity before drive operation until drive operation completes. The default setting is 10 V/100% torque.</p> <p>Enter a positive polarity during a motoring load, and enter a negative polarity during a regenerative load.</p> 
Time chart: Decrease	<p>Enter the analog signal as the torque compensation (torque bias) signal as specified by the load quantity before drive operation until drive operation completes. The default setting is 10 V/100% torque.</p> <p>Enter a negative polarity during a motoring load, and enter a positive polarity during a regenerative load.</p> 

Note:

- Holds through an external source to not change the torque compensation signal during run. If you change the torque compensation signal during run, the motor can oscillate.
- When you set motor reverse to the increase command and set motor forward to the decrease command, the polarity of the torque compensation signal will reverse.

Analog Input FilterTime Constant

When $b1-01 = 1$ [Frequency Reference Selection 1 = Analog Input], it adds noise to the analog frequency reference during run.

- Minimize the effects of noise.
- Change H3-13 [Analog Input FilterTime Constant] to a range of 0.01 s to 0.10 s.

Startup Current Check

When you do a test run, set $L8-41 = 1$ [*High Current Alarm Selection = Enabled*] and use $U4-13$ [*Peak Hold Current*] and a clamp ammeter with the machine under load and not under load to check the motor current during start up.

If the motor torque is not sufficient during start up or if the timing between the motor and the holding brake is unsatisfactory and causes the motor to lock, a large quantity of current will flow. In these conditions, adjust the parameters again and decrease the load to decrease the current to less than 150%. If the current flow is more than 150% of the drive rated current, the heat stress on the IGBTs will decrease the service life of drive parts.

To decrease the effects of heat stress, decrease the carrier frequency of the drive to 2.0 kHz to 2.5 kHz for applications where low audible noise is not necessary.

Overvoltage Suppression Function

If the overvoltage suppression function is used in elevator type applications, there is a risk of rollback and falls. Set $L3-11 = 0$ [*Overvoltage Suppression Select = Disabled*].

The overvoltage suppression function is designed to prevent an overvoltage trip in a situation in which a braking resistor is not used with a regenerative load. If the overvoltage suppression function is enabled, the regeneration torque reference within the drive is automatically controlled during regeneration.

Note:

When using the drive for applications such as high speed elevators with a speed of 2 ms or more and direct drive elevators, or when you need drives designed for cranes, contact Yaskawa or your Yaskawa sales representative.

■ A1-07: DriveWorksEZ Function Selection

No. (Hex.)	Name	Description	Default (Range)
A1-07 (0128)	DriveWorksEZ Function Selection	V/f CL-V/f OLV CLV AOLV OLV/PM AOLV/PM CLV/PM EZOLV Sets the drive to operate with DriveWorksEZ.	0 (0 - 2)

DriveWorksEZ is a simple visual programming tool that lets you connect function blocks to customize the drive and add PLC functions.

Note:

- DriveWorksEZ will overwrite drive settings when it uses MFDI/MFDO and MFAI/MFAO. When you use DriveWorksEZ to make changes to the drive, the changes will stay after you disable DriveWorksEZ.
- For more information about DriveWorksEZ, contact Yaskawa or your nearest sales representative.

0 : DWEZ Disabled

1 : DWEZ Enabled

2 : Enabled/Disabled wDigital Input

Set $H1-xx = 9F$ [*MFDI Function Select = DWEZ Disable*]. Deactivate the digital input to enable programs made with DriveWorksEZ. Activate the terminal to disable the programs.

If $A1-07 = 1$ [*DriveWorksEZ Function Selection = DWEZ Enabled*], the drive will continue to disable DWEZ when these conditions are true:

- Drive is not in operation
- The MFDI terminals set for $H1-xx = 9F$ activate.

■ A1-11: Firmware Update Lock

No. (Hex.)	Name	Description	Default (Range)
A1-11 (111D) Expert	Firmware Update Lock	V/f CL-V/f OLV CLV AOLV OLV/PM AOLV/PM CLV/PM EZOLV Protects the drive firmware. When you enable the protection, you cannot update the drive firmware.	0 (0, 1)

0 : Disabled

Lock is disabled.

1 : Enabled

Lock is enabled.

■ A1-12: Bluetooth ID

No. (Hex.)	Name	Description	Default (Range)
A1-12 (1564)	Bluetooth ID	V/f CL-V/f OLV CLV AOLV OLV/PM AOLV/PM CLV/PM EZOLV Sets the password necessary to use Bluetooth to control the drive with a smartphone or tablet.	- (0000 - 9999)

◆ A2: User Parameters

You can register frequently used parameters and recently changed parameters here to access them quickly. You can show the registered parameters in [User Custom Parameters] in the main menu.

■ A2-01 to A2-32: User Parameters 1 to 32

No. (Hex.)	Name	Description	Default (Range)
A2-01 to A2-32 (0106 - 0125)	User Parameters 1 to 32	V/f CL-V/f OLV CLV AOLV OLV/PM AOLV/PM CLV/PM EZOLV You can select a maximum of 32 parameters for the drive and set them to parameters <i>A2-01 to A2-32</i> . The [User Parameters] section of the keypad main menu shows the set parameters. You can immediately access these set parameters.	Parameters in General-Purpose Setup Mode (Determined by A1-06)

Note:

- When the *A1-06 [Application Preset]* value changes, the settings for *A2-01 to A2-32* change.
- You must set *A1-01 = 1 [Access Level Selection = User Parameters]* to access parameters *A2-01 to A2-32*.
- When *A1-07 = 1 or 2 [DriveWorksEZ Function Selection = DWEZ Enabled or Enabled/Disabled wDigital Input]*, the drive saves *qx-xx [DriveWorksEZ Parameters]* to *A2-01 to A2-32*.

The drive saves these parameters to *A2-01 to A2-32*.

- The drive saves a maximum of 32 parameters.

Note:

Set *A1-01 = 2 [Advanced Level]* or *A1-01 = 3 [Expert Level]* to save the necessary parameters.

- The drive automatically saves changed parameters to *A2-17 to A2-32*.

Note:

Set *A2-33 = 1 [User Parameter Auto Selection = Enabled: Auto Save Recent Parm]*.

■ A2-33: User Parameter Auto Selection

No. (Hex.)	Name	Description	Default (Range)
A2-33 (0126)	User Parameter Auto Selection	V/f CL-V/f OLV CLV AOLV OLV/PM AOLV/PM CLV/PM EZOLV Sets the automatic save feature for changes to parameters <i>A2-17 to A2-32 [User Parameters 17 to 32]</i> .	Determined by A1-06 (0, 1)

0 : Disabled: Manual Entry Required

Set User Parameters manually.

1 : Enabled: Auto Save Recent Parm

The drive automatically registers changed parameter *A2-17 to A2-32*. The drive automatically saves the most recently changed parameter to *A2-17*, and saves a maximum of 16 parameters. After the drive registers 16 parameters, when you save a new parameter, the drive will remove a parameter from the User Parameter list to make space for the new parameter. The drive removes parameters with First In, First Out.

You can show the registered parameters in [User Custom Parameters] in the main menu.

Note:

In General-Purpose Setup Mode, the drive saves parameters starting with *A2-27* because the drive saves parameters *A2-26* and lower by default.

12.3 b: Application

b parameters set the following functions.

- Frequency reference source/Run command source
- Stopping method settings
- DC Injection Braking
- Speed Search
- Timer Function
- PID control
- Dwell function
- Droop control
- Energy Savings Control
- Zero Servo Control

◆ b1: Operation Mode Selection

b1 parameters set the operation mode for the drive.

■ b1-01: Frequency Reference Selection 1

No. (Hex.)	Name	Description	Default (Setting Range)
b1-01 (0180)	Frequency Reference Selection 1	 Sets the input method for the frequency reference.	1 (0 - 4)

Note:

- Push on the keypad to set the input mode to LOCAL and enter the frequency reference from the keypad.
- When the drive receives a Run command when the frequency reference is 0 Hz or less than the *E1-09* [Minimum Output Frequency] value, on the keypad will flash. Examine the setting for the frequency reference input and enter a value more than or equal to *E1-09*.

0 : Keypad

Use the keypad to enter the frequency reference.

Use and on the keypad to change the frequency reference.

1 : Analog Input

Use MFAI terminals A1, A2, and A3 to input an analog frequency reference with a voltage or current input signal.

• Voltage Input

Refer to [Table 12.22](#) to use a voltage signal input to one of the MFAI terminals.

Table 12.22 Frequency Reference Voltage Input

Terminal	Terminal Signal Level	Parameter Settings				Note
		Signal Level Selection	Function Selection	Gain	Bias	
A1	0 - 10 V	H3-01 = 0	H3-02 = 0	H3-03	H3-04	Set DIP switch S1-1 to "V" for voltage input.
	-10 - +10 V	H3-01 = 1	[Frequency Reference]			
A2	0 - 10 V	H3-09 = 0	H3-10 = 0	H3-11	H3-12	Set DIP switch S1-2 to "V" for voltage input.
	-10 - +10 V	H3-09 = 1	[Frequency Reference]			
A3	0 - 10 V	H3-05 = 0	H3-06 = 0	H3-07	H3-08	Set DIP switch S1-3 to "V" for voltage input. Set DIP switch S4 to "AI" for analog input.
	-10 - +10 V	H3-05 = 1	[Frequency Reference]			

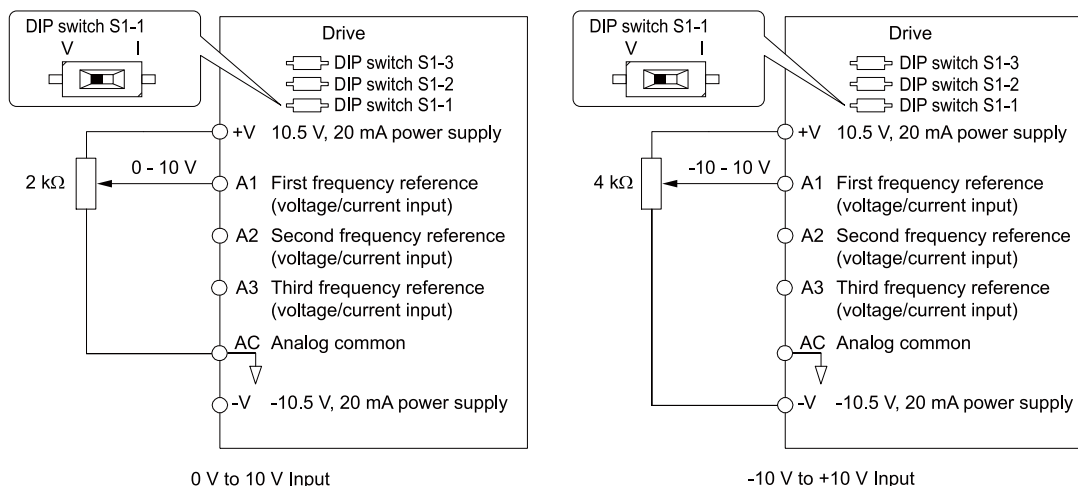

Figure 12.8 Example of Setting the Frequency Reference with a Voltage Signal to Terminal A1

Note:

You can also use this diagram to wire terminals A2 and A3.

• **Current Input**

Refer to [Table 12.23](#) to use a current signal input to one of the MFAI terminals.

Table 12.23 Frequency Reference Current Input

Terminal	Signal Level	Parameter Settings				Note
		Signal Level Selection	Function Selection	Gain	Bias	
A1	4 - 20 mA	H3-01 = 2	H3-02 = 0 [Frequency Reference]	H3-03	H3-04	Set DIP switch S1-1 to "I" for current input.
	0 - 20 mA	H3-01 = 3				
A2	4 - 20 mA	H3-09 = 2	H3-10 = 0 [Frequency Reference]	H3-11	H3-12	
	0 - 20 mA	H3-09 = 3				
A3	4 - 20 mA	H3-05 = 2	H3-06 = 0 [Frequency Reference]	H3-07	H3-08	Set DIP switch S1-3 to "I" for current input. Set DIP switch S4 to "AI" for analog input.
	0 - 20 mA	H3-05 = 3				

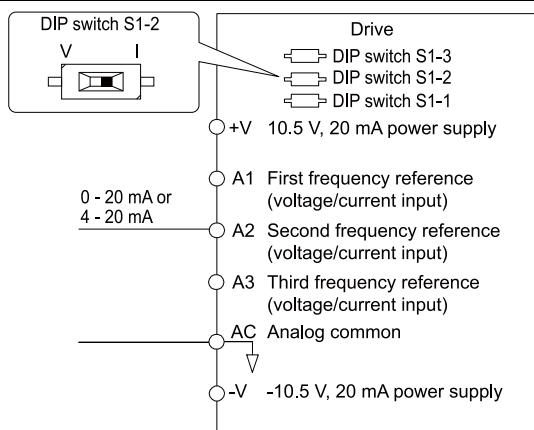

Figure 12.9 Example of Setting the Frequency Reference with a Current Signal to Terminal A2

Note:

You can also use this diagram to wire terminals A1 and A3.

Changing between Master and Auxiliary Frequency References

Use the multi-step speed reference function to change the frequency reference input between terminals A1, A2, and A3.

2 : Memobus/Modbus Communications

Use MEMOBUS/Modbus communications to enter the frequency reference.

3 : Option PCB

Use a communications option card or input option card connected to the drive to enter the Run command.

Refer to the instruction manual included with the option card to install and set the option card.

Note:

If $b1-01 = 3$, but you did not connect a communications option card, $oPE05$ [Run Cmd/Freq Ref Source Sel Err] will flash on the keypad.

4 : Pulse Train Input

Use a pulse train signal from the pulse train input terminal RP to enter the frequency reference.

Do this procedure to make sure that the pulse train signal is operating correctly.

1. Set $b1-01 = 4$, $H6-01 = 0$ [Terminal RP Pulse Train Function = Frequency Reference].
2. Set $H6-02$ [Terminal RP Frequency Scaling] to the number of pulses that determine 100% of the frequency reference.
3. Enter a pulse train signal on the terminal RP and make sure that the keypad shows a correct frequency reference.

■ **b1-02: Run Command Selection 1**

No. (Hex.)	Name	Description	Default (Range)
b1-02 (0181)	Run Command Selection 1	<input type="checkbox"/> V/f <input type="checkbox"/> CL-V/f <input type="checkbox"/> OLV <input type="checkbox"/> CLV <input type="checkbox"/> AOLV <input type="checkbox"/> OLV/PM <input type="checkbox"/> AOLV/PM <input type="checkbox"/> CLV/PM <input type="checkbox"/> EZOLV Sets the input method for the Run command.	1 (0 - 3)

0 : Keypad

Use the keypad to enter the Run command.

You can use the JOG operation or the FWD/REV commands from the keypad.

Note:

The  on the keypad is on while keypad is the Run command source.

1 : Analog Input

Use the control circuit terminals to enter the Run command. Select the input method for the Run command with an $H1-xx$ parameter.

Set $H1-xx = 0, 40$ to 43 [3-Wire Sequence, Run Command (2-Wire Sequence)]. The default setting is 2-wire sequence 1.

- 2-wire Sequence 1
This sequence has two input types: FWD/Stop and REV/Stop. Set $A1-03 = 2220$ [Initialize Parameters = 2-Wire Initialization] to initialize the drive and set terminals S1 and S2 for a 2-wire sequence.
- 2-wire Sequence 2
This sequence has two input types: Run/Stop and FWD/REV.
- 3-Wire Sequence
This sequence has three input types: Run, Stop, and FWD/REV. Set $A1-03 = 3330$ [Initialize Parameters = 3-Wire Initialization] to initialize the drive and set terminals S1, S2, and S5 for a 3-wire sequence.

2 : Memobus/Modbus Communications

Use MEMOBUS/Modbus communications to enter the Run command.

3 : Option PCB

Use a communications option card or input option card connected to the drive to enter the Run command.

Refer to the instruction manual included with the option card to install and set the option card.

Note:

If $b1-02 = 3$, but you did not connect a communications option card, $oPE05$ [Run Cmd/Freq Ref Source Sel Err] will flash on the keypad.

■ **b1-03: Stopping Method Selection**

No. (Hex.)	Name	Description	Default (Range)
b1-03 (0182)	Stopping Method Selection	<input type="checkbox"/> V/f <input type="checkbox"/> CL-V/f <input type="checkbox"/> OLV <input type="checkbox"/> CLV <input type="checkbox"/> AOLV <input type="checkbox"/> OLV/PM <input type="checkbox"/> AOLV/PM <input type="checkbox"/> CLV/PM <input type="checkbox"/> EZOLV Sets the method to stop the motor after removing a Run command or entering a Stop command.	0 (0 - 3, 9)

Note:

When $A1-02 = 3, 4, 5, 6, 7, 8$ [Control Method Selection = CLV, AOLV, OLV/PM, AOLV/PM, CLV/PM, EZOLV], the setting range is 0, 1, 3.

Select the applicable stopping method for the application from these four options:

0 : Ramp to Stop

When you enter the Stop command or turn OFF the Run command, the drive ramps the motor to stop.

The drive ramps the motor to stop as specified by the deceleration time. The default setting for the deceleration time is *C1-02 [Deceleration Time 1]*. The actual deceleration time changes as the load conditions change (for example, mechanical loss and inertia).

If the output frequency is less than or equal to the value set in *b2-01 [DC Injection/Zero SpeedThreshold]* during deceleration, the drive will do DC Injection Braking, Zero Speed Control, or Short Circuit Braking, as specified by the control method.

• Ramp to Stop with V/f, AOLV, CL-V/f, and OLV Control Methods

Parameter *b2-01* sets the frequency to start DC Injection Braking at stop. If the output frequency is less than or equal to the value set in *b2-01* during deceleration, then the drive will perform DC Injection Braking for the time set in *b2-04 [DC Inject Braking Time at Stop]*.

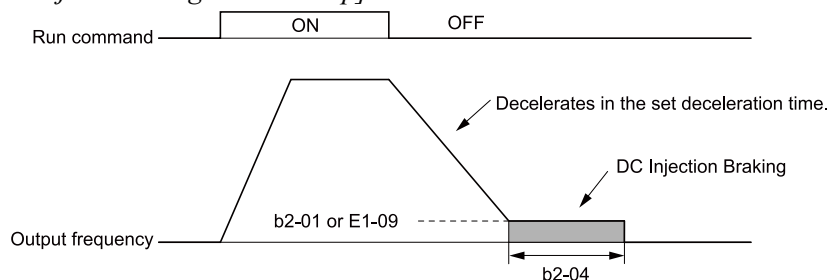

Figure 12.10 Ramp to Stop with V/f, AOLV, CL-V/f, and OLV Control Methods

Note:

When $b2-01 \leq E1-09$ [Minimum Output Frequency], the drive will start DC Injection Braking from the frequency set in *E1-09*.

• Ramp to Stop with OLV/PM, AOLV/PM, and EZOLV Control Methods

Parameter *b2-01* sets the frequency to start Short Circuit Braking. When the output frequency is less than or equal to the value set in *b2-01* during deceleration, then the drive will do Short Circuit Braking for the time set in *b2-13 [Short Circuit Brake Time @ Stop]*. When $b2-04 \neq 0$, the drive will do DC Injection Braking for the time set in *b2-04* when Short Circuit Braking is complete.

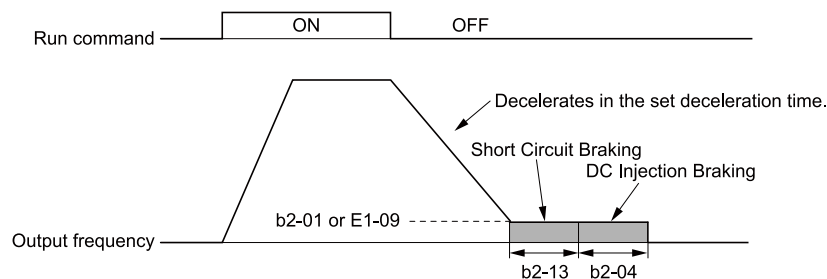

Figure 12.11 Ramp to Stop with OLV/PM, AOLV/PM, and EZOLV Control Methods

Note:

When $b2-01 \leq E1-09$, the drive will start Short Circuit Braking from the frequency set in *E1-09*.

If $b2-01 = 0$ Hz and $E1-09 = 0$ Hz, the drive will not do Short Circuit Braking.

• Ramp to Stop in CLV and CLV/PM Control Methods

Parameter *b2-01* sets the frequency to start Zero Speed Control at stop. When the output frequency is less than or equal to the value set in *b2-01* during deceleration, the drive will do Zero Speed Control for the time set in *b2-04*.

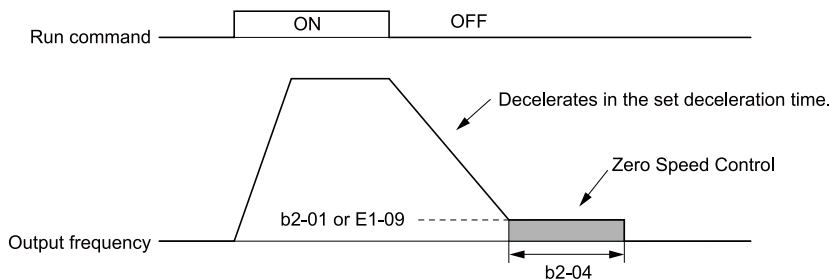

Figure 12.12 Ramp to Stop in CLV and CLV/PM Control Methods

Note:

When $b2-01 \leq E1-09$, the drive will start Zero Speed Control from the frequency set in $E1-09$.

1 : Coast to Stop

When you enter the Stop command or turn OFF the Run command, the drive turns OFF the output and coasts the motor to stop.

Load conditions will have an effect on the deceleration rate as the motor coasts to stop (for example, mechanical loss and inertia).

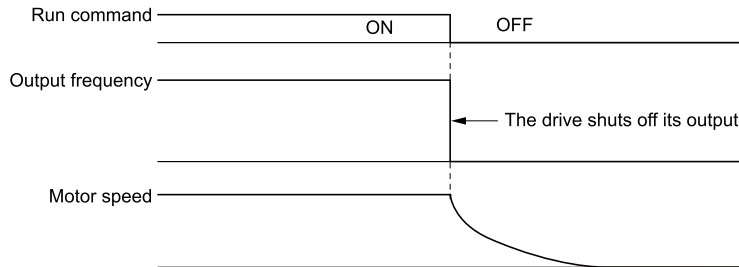

Figure 12.13 Coast to Stop

Note:

When you enter the Stop command or turn OFF the Run command, the drive ignores the Run command for the time set in $L2-03$ [Minimum Baseblock Time]. Do not enter the Run command until the motor comes to a complete stop. Use DC Injection or Speed Search to restart the motor before it stops.

2 : DC Injection Braking to Stop

When you enter the Stop command or turn OFF or Run command, the drive turns OFF the output for the time set in $L2-03$. The drive waits for the minimum baseblock time and then injects the amount of DC current into the motor set in $b2-02$ [DC Injection Braking Current] to stop the motor with DC current.

DC Injection Braking stops the motor more quickly than coast to stop.

Note:

If $A1-02 = 3, 4, 5, 6, \text{ or } 7$, DC Injection Braking to Stop is not available.

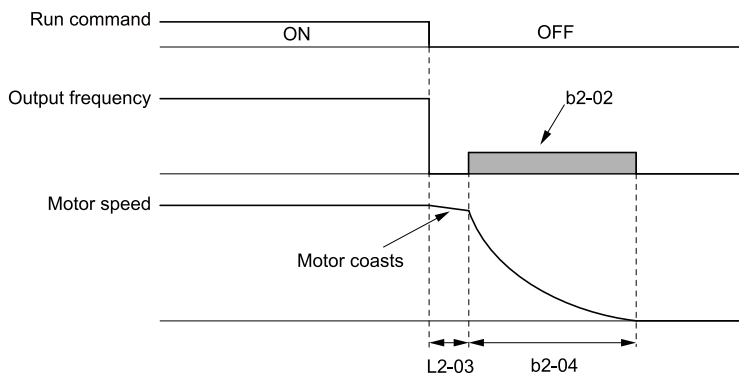

Figure 12.14 DC Injection Braking to Stop

The value set in $b2-04$ and the output frequency when the drive receives the Stop command determine the DC Injection Braking time. The drive calculates the DC Injection Braking time as in [Figure 12.15](#).

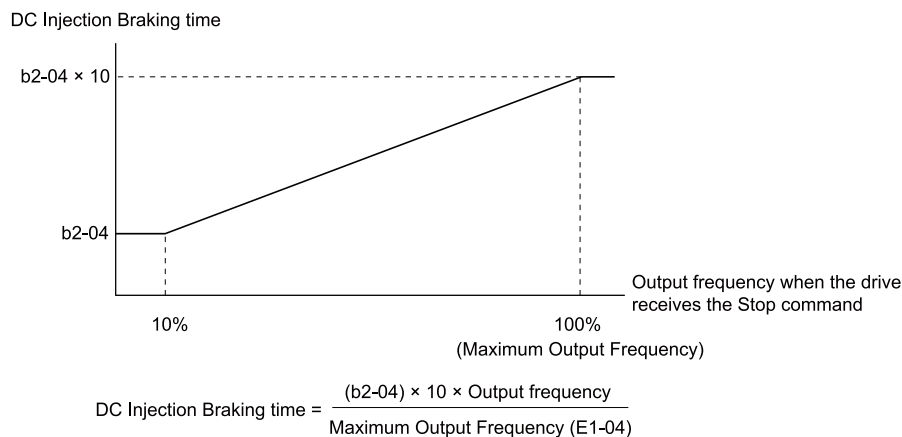

Figure 12.15 DC Injection Braking Time and Output Frequency

Note:

If the drive detects *oC* [Overcurrent] when it uses DC Injection Braking to stop the motor, set *L2-03* to a high value that will not trigger *oC*.

3 : Coast to Stop with Timer

When you enter the Stop command or turn OFF the Run command, the drive turns OFF the output and coasts the motor to stop. The drive ignores the Run command until the “Run wait time *t*” is expired.

To start the drive again, wait until the the “Run wait time *t*” is expired then enter the Run command.

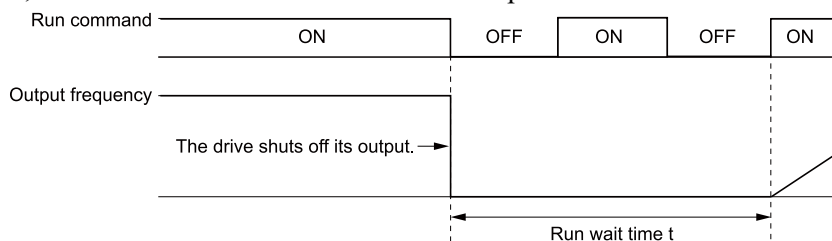

Figure 12.16 Coast to Stop with Timer

The active deceleration time and the output frequency when drive receives the Stop command determine the length of “Run wait time *t*”.

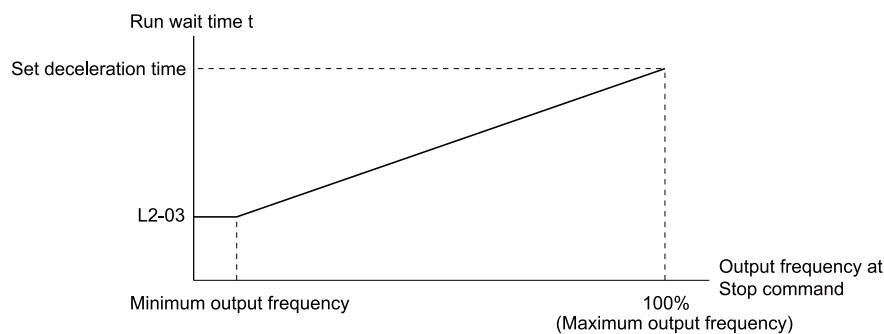

Figure 12.17 Run Wait Time and Output Frequency

9 : Stop with Constant Distance

When you enter the Stop command or turn OFF the Run command, the drive always decelerates for the same distance. The drive uses the active deceleration time and the value set in *E1-04* [Maximum Output Frequency] to calculate stopping distance *S1*. The drive holds its current speed when stopping from a frequency less than the maximum speed. When the distance covered is equal to *S1* minus *S2*, the drive ramps to stop in the current deceleration time. Adjust the stopping precision with *d4-12* [Stop Position Gain].

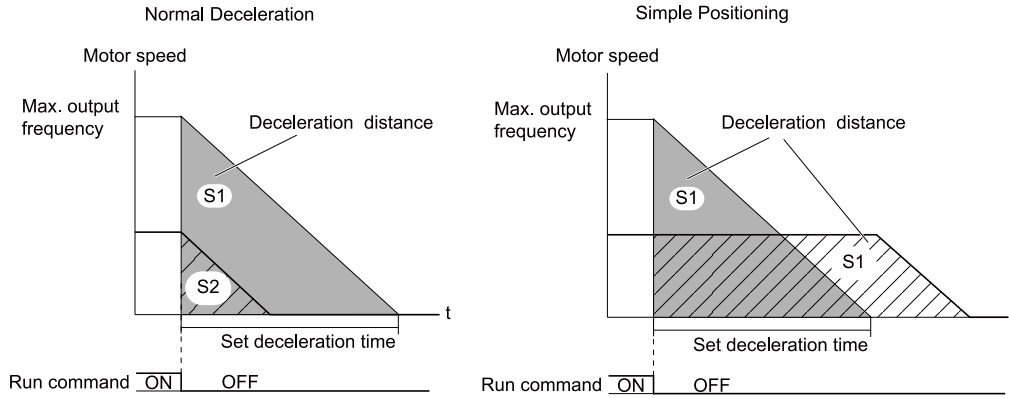

Figure 12.18 Deceleration When Set for Stop in Position

Note:

Note these points when setting Stop in Position.

- To calculate the stop time, the drive uses the active deceleration time in the drive when it received the Stop command or when the Run command was turned OFF. If you change the deceleration time during deceleration, the positioning will not be accurate.
- Set $b6-03 = 0.0$ [Dwell Reference at Stop = 0.0], $b6-04 = 0.0$ [Dwell Time at Stop = 0.0 s].
- The KEB Ride-Thru function is not available. Set $H1-xx \neq 65, 66, 7A, 7B$ [MFDI Function Selection = KEB Ride-Thru 1/2 Activate (N.O./N.C.)].
- Set $L3-04 = 0$ [Stall Prevention during Decel = Disabled]. A dynamic braking option can be necessary for regenerative loads.
- Set $L3-11 = 0$ [Overvoltage Suppression Select = Disabled].
- The High Slip Braking function is not available. Set $H1-xx \neq 68$ [MFDI Function Selection \neq High Slip Braking (HSB) Activate].
- Set $C2-03, C2-04 = 0.00$ [S-Curve Time @ Start of Decel, S-Curve Time @ End of Decel = 0.00 s].

■ **b1-04: Reverse Operation Selection**

No. (Hex.)	Name	Description	Default (Range)
b1-04 (0183)	Reverse Operation Selection	<input type="checkbox"/> V/f <input type="checkbox"/> CL-V/f <input type="checkbox"/> OLV <input type="checkbox"/> CLV <input type="checkbox"/> AOLV <input type="checkbox"/> OLV/PM <input type="checkbox"/> AOLV/PM <input type="checkbox"/> CLV/PM <input type="checkbox"/> EZOLV Sets the reverse operation function. Disable reverse operation in fan or pump applications where reverse rotation is dangerous.	0 (0, 1)

When reverse operation is prohibited, the drive will not accept a Reverse operation command.

0 : Reverse Enabled

The drive will accept a Reverse operation command.

1 : Reverse Disabled

The drive will not accept a Reverse operation command.

■ **b1-05: Operation Below Minimum Freq**

No. (Hex.)	Name	Description	Default (Range)
b1-05 (0184)	Operation Below Minimum Freq	<input type="checkbox"/> V/f <input type="checkbox"/> CL-V/f <input type="checkbox"/> OLV <input checked="" type="checkbox"/> CLV <input type="checkbox"/> AOLV <input type="checkbox"/> OLV/PM <input type="checkbox"/> AOLV/PM <input type="checkbox"/> CLV/PM <input type="checkbox"/> EZOLV Sets the drive operation when the frequency reference decreases to less than the value set in $E1-09$ [Minimum Output Frequency].	0 (0 - 3)

0 : Operate at Frequency Reference

When the frequency reference is less than the value set in $E1-09$, the drive will continue to operate the motor as specified by the frequency reference.

If the motor speed is less than or equal to the value set in $b2-01$ [DC Injection/Zero SpeedThreshold] when you enter the Stop command (or deactivate the Run command), the drive will do Zero Speed Control for the time set in $b2-04$ [DC Inject Braking Time at Stop] and then turn OFF its output.

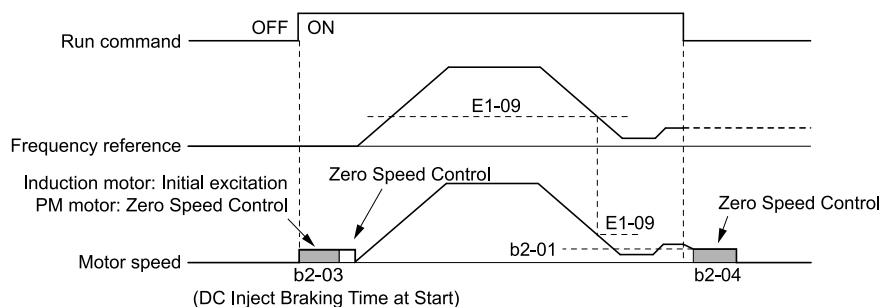

Figure 12.19 Operate at the Frequency Reference

1 : Baseblock (Motor Coasts)

If the frequency reference is less than the value set in *E1-09*, the drive stops motor voltage output and the motor coasts to stop. If the motor speed is less than or equal to the value set in *b2-01*, the drive will do Zero Speed Control for the time set in *b2-04*.

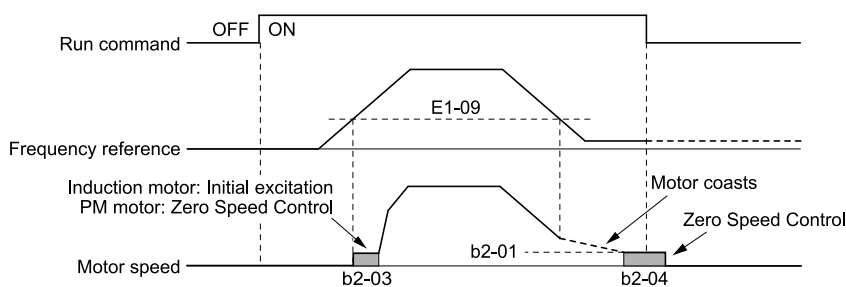

Figure 12.20 Coast to Stop

2 : Operate at Minimum Frequency

The drive operates the motor at the minimum frequency reference set in *E1-09* when the frequency reference falls below the value set in *E1-09* and the Run command is still enabled.

The drive decelerates the motor when the Stop command is entered (or when the Run command is switched OFF). If the motor speed falls below or is equal to the value set in *b2-01*, then the drive will perform Zero Speed Control for the time set in *b2-04*.

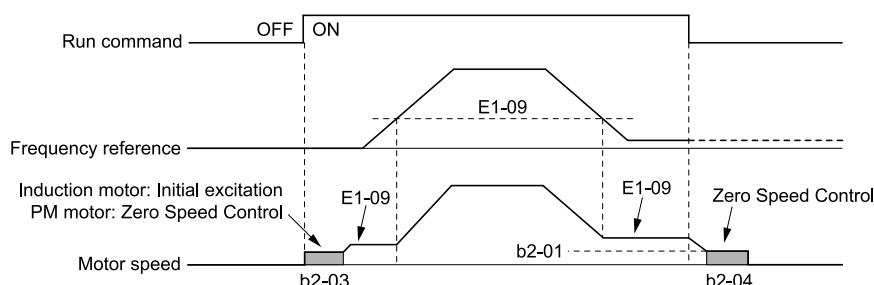

Figure 12.21 Operate at Minimum Frequency

3 : Operate at Zero Speed

The drive performs Zero Speed Control when the frequency reference falls below the value set in *E1-09*.

When you enter the Stop command (or when you turn OFF the Run command), the drive does Zero Speed Control again for the time set in *b2-04*.

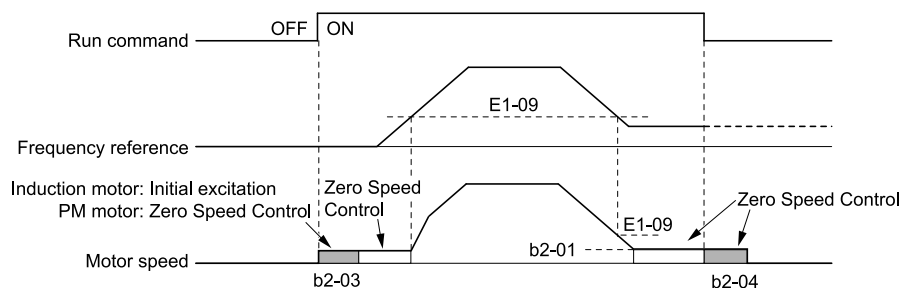

Figure 12.22 Operate at Zero Speed

■ b1-06: Digital Input Reading

No. (Hex.)	Name	Description	Default (Range)
b1-06 (0185)	Digital Input Reading	<div style="display: flex; justify-content: space-between; font-size: 0.8em; font-weight: bold;"> V/f CL-V/f OLV CLV AOLV OLV/PM AOLV/PM CLV/PM EZOLV </div> Sets the number of times that the drive reads the sequence input command to prevent malfunction because of electrical interference.	1 (0, 1)

0 : Single Scan

The drive reads the terminal status one time. The drive immediately reads all changes to the terminal status.

This setting lets the drive quickly respond to changes in the sequence, but noise can cause malfunction.

1 : Double Scan

The drive reads all changes to the terminal status two times to make sure that the reading is the same.

The drive responds slower than when it reads the sequence one time, but this setting prevents malfunction because of electrical interference.

■ b1-07: LOCAL/REMOTE Run Selection

No. (Hex.)	Name	Description	Default (Range)
b1-07 (0186)	LOCAL/REMOTE Run Selection	<div style="display: flex; justify-content: space-between; font-size: 0.8em; font-weight: bold;"> V/f CL-V/f OLV CLV AOLV OLV/PM AOLV/PM CLV/PM EZOLV </div> Sets drive response to an existing Run command when the drive receives a second Run command from a different location.	0 (0, 1)

This parameter interlocks the drive to help prevent accidents that can occur if the motor starts to rotate because the Run command source changed.

To switch the RUN command source, push **LORE** on the keypad or set $HI-xx = 1, 2$ [*MFDI Function Selection = LOCAL/REMOTE Selection, External Reference 1/2 Selection*] and activate/deactivate the terminal.

0 : Disregard Existing RUN Command

If a Run command is enabled when you switch between Run command sources, the drive will not operate the motor.

When the drive is operating the motor, turn OFF the Run command to stop the motor. Enter the Run command again to start operation.

1 : Accept Existing RUN Command

If a Run command is enabled when you switch between Run command sources, the drive will start to operate the motor or continue to operate the motor.

WARNING! *Sudden Movement Hazard. When you use a 3-Wire sequence, set A1-03 = 3330 [Initialize Parameters = 3-Wire Initialization] and make sure that b1-17 = 0 [Run Command at Power Up = Disregard Existing RUN Command] (default). If you do not correctly set the drive parameters for 3-Wire operation before you energize the drive, the motor can suddenly rotate when you energize the drive.*

■ b1-08: Run Command Select in PRG Mode

No. (Hex.)	Name	Description	Default (Range)
b1-08 (0187)	Run Command Select in PRG Mode	<div style="display: flex; justify-content: space-between; font-size: 0.8em; font-weight: bold;"> V/f CL-V/f OLV CLV AOLV OLV/PM AOLV/PM CLV/PM EZOLV </div> Sets the conditions for the drive to accept a Run command entered from an external source when using the keypad to set parameters.	0 (0 - 2)

As a safety precaution, when the drive is in Programming Mode, it will not respond to a Run command.

This parameter helps prevent accidents that can occur if the motor starts to rotate because the drive received a Run command from an external source while the user is programming the drive. You can also set the drive to not show the Programming Mode when a Run command is active.

Note:

Refer to this table for Drive Mode and Programming Mode functions.

Mode	Keypad Screen	Function
Drive Mode	Monitors	Sets monitor display.
Programming Mode	Parameters	Changes parameter settings.
	User Custom Parameters	Shows the User Parameters.
	Parameter Backup/Restore	Saves parameters to the keypad as backup.
	Modified Parameters/Fault Log	Shows modified parameters and fault history.
	Auto-Tuning	Auto-Tunes the drive.
	Initial Setup Screen	Changes initial settings.
	Diagnostic Tools	Sets data logs and backlight.

0 : Disregard RUN while Programming

The drive does not accept the Run command when setting the parameters in the Programming Mode.









1 : Accept RUN while Programming

The drive accepts a Run command entered from an external source when setting the parameters in Programming Mode.









2 : Allow Programming Only at Stop

The drive does not allow the user to enter the Programming Mode while the drive is operating. The keypad does not display the Programming Mode while the drive is operating.

■ b1-14: Phase Order Selection

No. (Hex.)	Name	Description	Default (Range)
b1-14 (01C3)	Phase Order Selection	         Sets the phase order for output terminals U/T1, V/T2, and W/T3. This parameter can align the Forward Run command from the drive and the forward direction of the motor without changing wiring.	0 (0, 1)

0 : Standard**1 : Switch Phase Order****■ b1-15: Frequency Reference Selection 2**

No. (Hex.)	Name	Description	Default (Range)
b1-15 (01C4)	Frequency Reference Selection 2	         Sets the input method for frequency reference 2.	0 (0 - 4)

This parameter is enabled when $H1-xx = 2$ [*MFDI Function Selection = External Reference 1/2 Selection*] is activated.



Note:

• Push  on the keypad to set the input mode to LOCAL and enter the frequency reference from the keypad.

• If the frequency reference is 0 Hz or $\leq E1-09$ [*Minimum Output Frequency*] and the drive receives a Run command, the  on the keypad will flash. Check the setting for the frequency reference input and enter a value more than or equal to $E1-09$.

0 : Keypad

Use the keypad to enter the frequency reference.

Use  and  on the keypad to change the frequency reference.

1 : Analog Input

Use MFAI terminals A1, A2, and A3 to input an analog frequency reference with a voltage or current input signal.

• Voltage Input

Refer to [Table 12.24](#) to use a voltage signal input to one of the MFAI terminals.

Table 12.24 Frequency Reference Voltage Input

Terminal	Terminal Signal Level	Parameter Settings				Note
		Signal Level Selection	Function Selection	Gain	Bias	
A1	0 - 10 V	H3-01 = 0	H3-02 = 0 [Frequency Reference]	H3-03	H3-04	Set DIP switch S1-1 to "V" for voltage input.
	-10 - +10 V	H3-01 = 1				
A2	0 - 10 V	H3-09 = 0	H3-10 = 0 [Frequency Reference]	H3-11	H3-12	Set DIP switch S1-2 to "V" for voltage input.
	-10 - +10 V	H3-09 = 1				
A3	0 - 10 V	H3-05 = 0	H3-06 = 0 [Frequency Reference]	H3-07	H3-08	Set DIP switch S1-3 to "V" for voltage input. Set DIP switch S4 to "AI" for analog input.
	-10 - +10 V	H3-05 = 1				

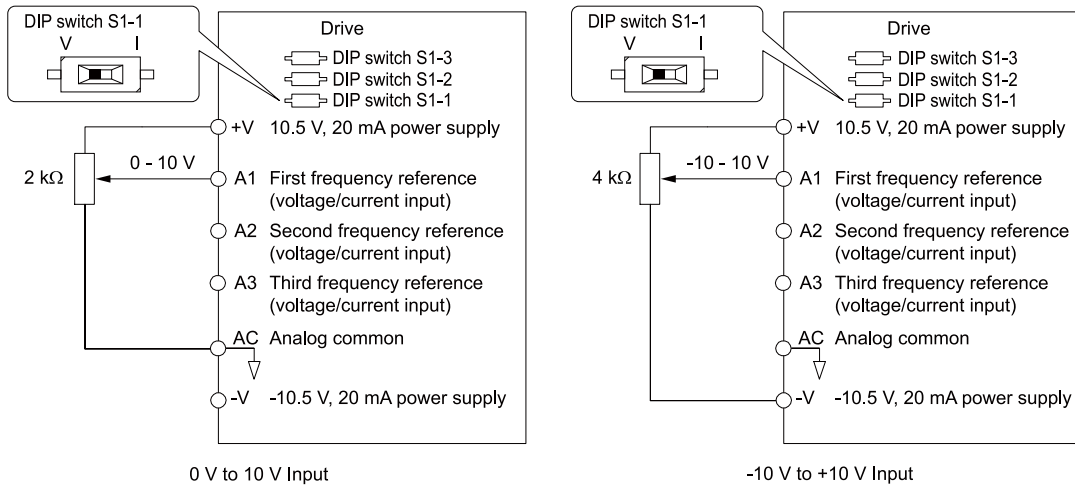

Figure 12.23 Example of Setting the Frequency Reference with a Voltage Signal to Terminal A1

Note:

You can also use this diagram to wire terminals A2 and A3.

• **Current Input**

Refer to [Table 12.25](#) to use a voltage signal input to one of the MFAI terminals.

Table 12.25 Frequency Reference Current Input

Terminal	Signal Level	Parameter Settings				Note
		Signal Level Selection	Function Selection	Gain	Bias	
A1	4 mA to 20 mA	H3-01 = 2	H3-02 = 0 [Frequency Reference]	H3-03	H3-04	Set DIP switch S1-1 to "I" for current input.
	0 - 20 mA	H3-01 = 3				
A2	4 mA to 20 mA	H3-09 = 2	H3-10 = 0 [Frequency Reference]	H3-11	H3-12	Set DIP switch S1-2 to "I" for current input.
	0 - 20 mA	H3-09 = 3				
A3	4 mA to 20 mA	H3-05 = 2	H3-06 = 0 [Frequency Reference]	H3-07	H3-08	Set DIP switch S1-3 to "I" for current input. Set DIP switch S4 to "AI" for analog input.
	0 - 20 mA	H3-05 = 3				

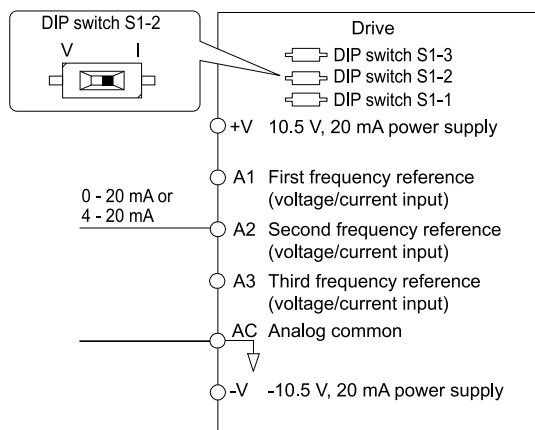

Figure 12.24 Example of Setting the Frequency Reference with a Current Signal to Terminal A2

Note:

You can also use this diagram to wire terminals A1 and A3.

Changing between Master and Auxiliary Frequency References

Use the multi-step speed reference function to change the frequency reference input between terminals A1, A2, and A3.

2 : Memobus/Modbus Communications

Use MEMOBUS/Modbus communications to enter the frequency reference.

3 : Option PCB

Use a communications option card or input option card connected to the drive to enter the Run command. Refer to the instruction manual included with the option card to install and set the option card.

Note:

If $b1-15 = 3$ but no option card is connected, then *oPE03 [Multi-Function Input Setting Err]* will flash on the keypad.

4 : Pulse Train Input

Use a pulse train signal from the pulse train input terminal RP to enter the frequency reference.

Do this procedure to make sure that the pulse train signal is operating correctly.

1. Set $b1-15 = 4$, $H6-01 = 0$ [*Terminal RP Pulse Train Function = Frequency Reference*].
2. Set $H6-02$ [*Terminal RP Frequency Scaling*] to the number of pulses that determine 100% of the frequency reference.
3. The terminal assigned to $H1-xx = 2$ [*MFDI Function Selection = External Reference 1/2 Selection*] is activated.
4. Enter a pulse train signal on the terminal RP and make sure that the keypad shows a correct frequency reference.

■ b1-16: Run Command Selection 2

No. (Hex.)	Name	Description	Default (Range)
b1-16 (01C5)	Run Command Selection 2	<div style="display: flex; gap: 5px;"> V/f CL-V/f OLV CLV AOLV OLV/PM AOLV/PM CLV/PM EZOLV </div> Sets the input method for Run Command 2 when the user switches the control circuit terminals ON/OFF to change the Run command source.	0 (0 - 3)

Activate $H1-xx = 2$ [*MFDI Function Selection = External Reference 1/2 Selection*] to enable this parameter.

0 : Keypad

Use the keypad to enter the Run command.

You can use the JOG operation or the FWD/REV commands from the keypad.

Note:

The  is on while the keypad is the Run command source.

1 : Digital Input

Use the control circuit terminals to enter the Run command. Select the input method for the Run command with an $H1-xx$ parameter.

12.3 b: Application

Set $H1-xx = 0, 40$ to 43 [*3-Wire Sequence, Run Command (2-Wire Sequence)*]. The default setting is 2-wire sequence 1.

- 2-wire Sequence 1

This sequence has two input types: FWD/Stop and REV/Stop. Set $A1-03 = 2220$ [*Initialize Parameters = 2-Wire Initialization*] to initialize the drive and set terminals S1 and S2 for a 2-wire sequence.

- 2-wire Sequence 2

This sequence has two input types: Run/Stop and FWD/REV.

- 3-Wire Sequence

This sequence has three input types: Run, Stop, and FWD/REV. Set $A1-03 = 3330$ [*Initialize Parameters = 3-Wire Initialization*] to initialize the drive and set terminals S1, S2, and S5 for a 3-wire sequence.

2 : Memobus/Modbus Communications

Use MEMOBUS/Modbus communications to enter the Run command.

3 : Option PCB

Use a communications option card or input option card connected to the drive to enter the Run command.

Refer to the instruction manual included with the option card to install and set the option card.

Note:

If $b1-16 = 3$ but no option card is connected, then $oPE03$ [*Multi-Function Input Setting Err*] will flash on the keypad.

■ b1-17: Run Command at Power Up

No. (Hex.)	Name	Description	Default (Range)
b1-17 (01C6)	Run Command at Power Up	<div style="display: flex; justify-content: space-between; font-size: small;"> V/f CL-V/f OLV CLV AOLV OLV/PM AOLV/PM CLV/PM EZOLV </div> <p>Sets drive response when the CPU changes from de-energized to energized and there is an active Run command. Set this parameter in applications where energizing or de-energizing the drive enables the Run command. When the CPU stays energized during loss of power, $L2-01$ [<i>Power Loss Ride Through Select</i>] sets operation.</p>	0 (0, 1)

0 : Disregard Existing RUN Command

The drive does not start to operate the application when you apply power, even when there is an existing Run command.

Enter the Run command again to operate the application.

Note:

When you energize the drive,  on the keypad will flash quickly if the Run command is already enabled from an external source.

1 : Accept Existing RUN Command

When there is an existing Run command, the drive starts to operate the application when you apply power.

WARNING! Sudden Movement Hazard. When you use a 3-Wire sequence, set $A1-03 = 3330$ [*Initialize Parameters = 3-Wire Initialization*] and make sure that $b1-17 = 0$ [*Run Command at Power Up = Disregard Existing RUN Command*] (default). If you do not correctly set the drive parameters for 3-Wire operation before you energize the drive, the motor can suddenly rotate when you energize the drive.

■ b1-21: CLV Start Selection

No. (Hex.)	Name	Description	Default (Range)
b1-21 (0748) Expert	CLV Start Selection	<div style="display: flex; justify-content: space-between; font-size: small;"> V/f CL-V/f OLV CLV AOLV OLV/PM AOLV/PM CLV/PM EZOLV </div> <p>Sets the conditions for the drive to accept a Run command when $A1-02 = 3, 7$ [<i>Control Method Selection = CLV, CLV/PM</i>]. Usually it is not necessary to change this setting.</p>	0 (0, 1)

0 : Reject RUN if $b2-01 < U1-05 < E1-09$

If the motor speed $\geq b2-01$ or the motor speed $< E1-09$, the drive will not accept a Run command.

1 : Accept RUN Command at Any Speed

If the motor speed $\geq b2-01$ or the motor speed $< E1-09$, the drive will accept a Run command.

■ b1-35: Digital Input Deadband Time

No. (Hex.)	Name	Description	Default (Range)
b1-35 (1117) Expert	Digital Input Deadband Time	<div style="display: flex; justify-content: space-between; font-size: small;"> V/f CL-V/f OLV CLV AOLV OLV/PM AOLV/PM CLV/PM EZOLV </div> <p>Sets the deadband time for MFDIs.</p>	0.0 ms (0.0 to 100.0 ms)

When the on/off time for MFDIs is longer than the time set in *b1-35*, the drive activates the MFDI. Set this parameter to prevent malfunctions caused by relay chattering for applications in which relays send input to MFDI terminals.

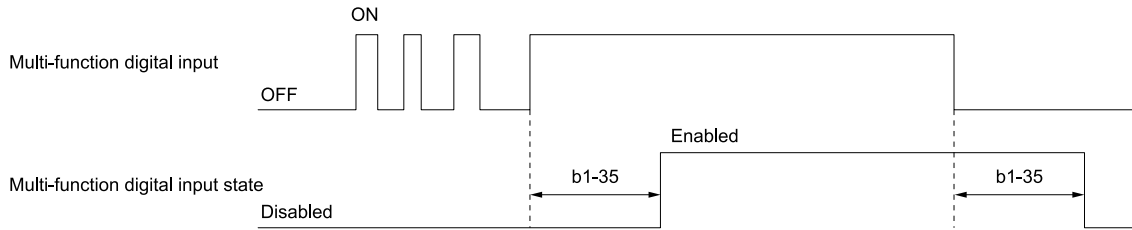

◆ b2: DC Injection Braking and Short Circuit Braking

b2 parameters set the DC Injection Braking and Short Circuit Braking functions.

- DC Injection Braking: A braking method that injects DC current into the motor windings. This function should not be used too frequently, because it generates a fair amount of heat in the motor.
- Short Circuit Braking: A braking method for PM motors.

■ b2-01: DC Injection/Zero SpeedThreshold

No. (Hex.)	Name	Description	Default (Range)
b2-01 (0189)	DC Injection/Zero SpeedThreshold	V/f CL-V/f OLV CLV AOLV OLV/PM AOLV/PM CLV/PM EZOLV Sets the frequency to start DC Injection Braking, Short Circuit Braking, or Zero Servo near the end of a stop ramp.	Determined by A1-02 (0.0 - 10.0 Hz)

Note:

This parameter is available when *b1-03* = 0 [Stopping Method Selection = Ramp to Stop].

When the control method selected in *A1-02* [Control Method Selection] changes, the *b2-01* function changes.

Parameter Settings	Functions of b2-01
<i>A1-02</i> = 0, 1, 2 [V/f, CL-V/f, OLV] <i>A1-02</i> = 4 [AOLV] and <i>n4-72</i> = 0 [Speed Feedback Mode = With Encoder]	Parameter <i>b2-01</i> sets the frequency to start DC Injection Braking at stop. When the output frequency is less than or equal to the value set in <i>b2-01</i> , the drive will inject the quantity of DC current set in <i>b2-02</i> [DC Injection Braking Current] into the motor for the time set in <i>b2-04</i> [DC Inject Braking Time at Stop]. <p style="text-align: center;">Figure 12.25 DC Injection Braking at Stop</p> <p>Note: When $b2-01 \leq E1-09$ [Minimum Output Frequency], the drive will start DC Injection Braking from the frequency set in <i>E1-09</i>.</p>
<i>A1-02</i> = 5, 6, 8 [OLV/PM, AOLV/PM, EZOLV]	Parameter <i>b2-01</i> sets the frequency to start Short Circuit Braking at stop. When the output frequency is less than or equal to the value set in <i>b2-01</i> , the drive will do Short Circuit Braking for the time set in <i>b2-13</i> [Short Circuit Brake Time @ Stop]. When $b2-04 > 0.00$ s, the drive will complete Short Circuit Braking, then do DC Injection Braking for the time set in <i>b2-04</i> . <p style="text-align: center;">Figure 12.26 Short Circuit Braking at Stop</p> <p>Note: When $b2-01 \leq E1-09$, the drive will start Short Circuit Braking from the frequency set in <i>E1-09</i>. If $b2-01$ and <i>E1-09</i> = 0 Hz, the drive will not do Short Circuit Braking.</p>

Parameter Settings	Functions of b2-01
A1-02 = 3, 7 [CLV, CLV/PM] A1-02 = 4 [AOLV] and n4-72 = 1 [With Encoder]	<p>Parameter b2-01 sets the frequency to start Zero Speed Control at stop. When the output frequency is less than or equal to the value set in b2-01, the drive will do Zero Speed Control for the time set in b2-04.</p> <p style="text-align: center;">Figure 12.27 Zero Speed Control at Stop</p> <p>Note: When $b2-01 \leq E1-09$ [Minimum Output Frequency], the drive will start Zero Speed Control from the frequency set in E1-09.</p>

■ b2-02: DC Injection Braking Current

No. (Hex.)	Name	Description	Default (Range)
b2-02 (018A)	DC Injection Braking Current	V/f CL-V/f OLV CLV AOLV OLV/PM AOLV/PM CLV/PM EZOLV Sets the DC Injection Braking current as a percentage of the drive rated current.	50% (0 - 100%)

When the DC Injection Braking current is more than 50%, the drive decreases the carrier frequency to 1 kHz. The motor rated current determines how much DC Injection Braking current that the drive can use.

The DC Injection Braking current level has an effect on the strength of the magnetic field that locks the motor shaft. As the current level increases, the motor windings will supply more heat. Do not set this parameter higher than the level that is necessary to hold the motor shaft.

Note:

When A1-02 = 4 [Control Method Selection = AOLV] and n4-72 = 1 [Speed Feedback Mode = With Encoder], the drive ignores the b2-02 setting and does initial excitation.

■ b2-03: DC Inject Braking Time at Start

No. (Hex.)	Name	Description	Default (Range)
b2-03 (018B)	DC Inject Braking Time at Start	V/f CL-V/f OLV CLV AOLV OLV/PM AOLV/PM CLV/PM EZOLV Sets the DC Injection Braking Time at stop. Sets the time of Zero Speed Control at start when A1-02 = 3, 7 [Control Method Selection = CLV, CLV/PM].	A1-02 = 4: 0.30 s Other than A1-02 = 4: 0.00 s (0.00 - 10.00 s)

This function stops then restarts a coasting motor and increases motor flux to make high starting torque (a process called initial excitation). Set this parameter to 0.00 to disable the function.

Note:

- To restart a coasting motor, use DC Injection Braking to stop and then restart the motor, or enable Speed Search. Enable DC Injection Braking or Speed Search to prevent *ov* [Overvoltage] or *oC* [Overcurrent] faults.
- Sets the time of Initial Excitation at start when A1-02 = 4 [AOLV] and n4-72 = 1 [Speed Feedback Mode = Without Encoder].

■ b2-04: DC Inject Braking Time at Stop

No. (Hex.)	Name	Description	Default (Range)
b2-04 (018C)	DC Inject Braking Time at Stop	V/f CL-V/f OLV CLV AOLV OLV/PM AOLV/PM CLV/PM EZOLV Sets the DC Injection Braking Time at stop. Sets the time of Zero Speed Control at stop when A1-02 = 3, 7 [Control Method Selection = CLV, CLV/PM].	Determined by A1-02 (0.00 - 10.00 s)

This function fully stops a motor with a large inertia during deceleration and will not let the inertia continue to rotate the motor.

Set this parameter to 0.00 to disable the function.

When a longer time is required to stop the motor, increase the value.

Note:

Sets the time of Zero Speed Control at stop when A1-02 = 4 [AOLV] and n4-72 = 1 [Speed Feedback Mode = With Encoder].

■ b2-08: Magnetic Flux Compensation Value

No. (Hex.)	Name	Description	Default (Range)
b2-08 (0190)	Magnetic Flux Compensation Value	<div style="display: flex; justify-content: space-between; font-size: small;"> V/f CL-V/f OLV CLV AOLV OLV/PM AOLV/PM CLV/PM EZOLV </div> Sets how much current the drive injects when DC Injection Braking at Start starts (Initial Excitation) as a percentage of E2-03 [Motor No-Load Current].	0% (0 - 1000%)

This parameter is effective when you start a high-capacity motor (a motor with a large secondary circuit time constant). This function can quickly increase motor flux to make high starting torque (a process called initial excitation).

The current level for DC Injection Braking at start changes linearly from the setting of b2-08 to the setting of b2-03 as shown in Figure 12.28.

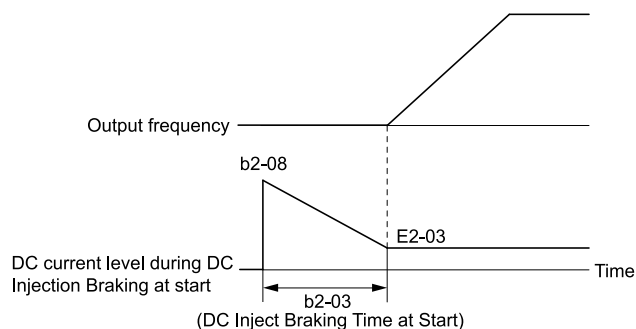

Figure 12.28 DC Current Level during DC Injection Braking at Start

Note:

- If $b2-08 < 100\%$, flux will develop very slowly.
- When $b2-08 = 0\%$, the DC current level will be the DC Injection current set in b2-02 [DC Injection Braking Current].
- If $b2-08$ is set too high, DC Injection Braking at start can cause a large noise. Adjust $b2-08$ to decrease the volume to the permitted level.

■ b2-12: Short Circuit Brake Time @ Start

No. (Hex.)	Name	Description	Default (Range)
b2-12 (01BA)	Short Circuit Brake Time @ Start	<div style="display: flex; justify-content: space-between; font-size: small;"> V/f CL-V/f OLV CLV AOLV OLV/PM AOLV/PM CLV/PM EZOLV </div> Sets the Short Circuit Braking time at start.	0.00 s (0.00 - 25.50 s)

This function stops and restarts a coasting PM motor. The drive short circuits all the three motor phases to make braking torque in the motor.

Set this parameter to 0.00 to disable the function.

Note:

- Short circuit Braking will let external forces rotate the PM motor. Use DC Injection Braking to prevent motor rotation from external forces.
- Motor speed and load conditions can make it necessary to install a dynamic braking option on the drive.

■ b2-13: Short Circuit Brake Time @ Stop

No. (Hex.)	Name	Description	Default (Range)
b2-13 (01BB)	Short Circuit Brake Time @ Stop	<div style="display: flex; justify-content: space-between; font-size: small;"> V/f CL-V/f OLV CLV AOLV OLV/PM AOLV/PM CLV/PM EZOLV </div> Sets the Short Circuit Braking time at stop.	A1-02 = 8: 0.00 s Other than A1-02 = 8: 0.50 s (0.00 - 25.50 s)

This function fully stops a PM motor with a large inertia during deceleration and will not let the inertia continue to rotate the motor.

Short Circuit Braking operates for the time set in b2-13 when output frequency is less than the value set in b2-01 [DC Injection/Zero SpeedThreshold] or E1-09 [Minimum Output Frequency].

Set this parameter to 0.00 to disable the function.

Note:

- Motor speed and load conditions can make it necessary to install a dynamic braking option on the drive.

■ b2-18: Short Circuit Braking Current

No. (Hex.)	Name	Description	Default (Range)
b2-18 (0177)	Short Circuit Braking Current	V/f CL-V/f OLV CLV AOLV OLV/PM AOLV/PM CLV/PM EZOLV Sets the Short Circuit Braking Current as a percentage of the motor rated current.	100.0% (0.0 - 200.0%)

The Short Circuit Braking current cannot be higher than the drive rated current, although you can use *b2-18* to set a higher current level. The maximum rated current is 120% when the drive is set for Normal Duty (*C6-01 = 1* [Normal Duty Rating]). The maximum rated current is 150% when the drive is set for Heavy Duty (*C6-01 = 0* [Heavy Duty Rating]).

◆ b3: Speed Search

The Speed Search function detects the actual speed of a coasting motor, then restarts the motor before the motor stops. Use Speed Search in these conditions:

- To continue operation after momentary power loss
- To switch from commercial power supply to drive power
- To restart a coasting fan

For example, the drive output turns off and the motor coasts when there is a momentary loss of power. After you return power, the drive does Speed Search on the coasting motor, and restarts the motor from the detected speed.

When you use a PM motor, enable *b3-01* [Speed Search at Start Selection].

There are two types of Speed Search for induction motors: Current Detection and Speed Estimation. Use parameter *b3-24* [Speed Search Method Selection] to select the type of Speed Search.

Parameter settings are different for different types of Speed Search. Refer to [Table 12.26](#) for more information.

Table 12.26 Speed Search and Related Parameters

Parameter	Speed Estimation	Current Detection 2
	b3-24 = 1	b3-24 = 2
b3-01 [Speed Search at Start Selection]	x	x
b3-03 [Speed Search Deceleration Time]	-	x
b3-05 [Speed Search Delay Time]	x	x
b3-06 [Speed Estimation Current Level 1]	x	-
b3-07 [Speed Estimation Current Level 2]	x	-
b3-08 [Speed Estimation ACR P Gain]	x	-
b3-09 [Speed Estimation ACR I Time]	x	-
b3-10 [Speed Estimation Detection Gain]	x	-
b3-14 [Bi-directional Speed Search]	x	x [*] /
b3-17 [Speed Est Retry Current Level]	x	x
b3-18 [Speed Est Retry Detection Time]	x	x
b3-19 [Speed Search Restart Attempts]	x	x
b3-24 [Speed Search Method Selection]	x	x
b3-25 [Speed Search Wait Time]	x	x
b3-26 [Direction Determination Level]	x	-
b3-27 [Speed Search RUN/BB Priority]	x	x
b3-29 [Speed Search Back-EMF Threshold]	-	-
b3-31 [Spd Search Current Reference Lvl]	-	x
b3-32 [Spd Search Current Complete Lvl]	-	x
b3-33 [Speed Search during Uv Selection]	x	x
b3-35 [Low Back EMF Detection Level]	x	x
b3-36 [High Back EMF Detection Level]	x	x
b3-54 [Search Time]	-	-

Parameter	Speed Estimation	Current Detection 2
	b3-24 = 1	b3-24 = 2
b3-55 [Current Increment Time]	-	-
b3-56 [InverseRotationSearch WaitTime]	-	x

*1 On drives with software versions PRG: 01023 and later, this function is enabled. On drives with software versions PRG: 01022 and earlier, when $b3-24 = 2$ [Speed Search Method Selection = Current Detection 2], setting $b3-14 = 1$ will not have an effect on the drive operation. The "PRG" column on the nameplate on the right side of the drive identifies the software version. You can also use $U1-25$ [SoftwareNumber Flash] to identify the software version.

Note:

- To use Speed Estimation Speed Search with V/f Control, do Rotational Auto-Tuning before you set the Speed Search function. If the wire length between the drive and motor changed since the last time you did Auto-Tuning, do Stationary Auto-Tuning for Line-to-Line Resistance process again.
- If $A1-02 = 5, 6$ [PM Open Loop Vector, PM Advanced Open Loop Vector] and the wiring distance between the motor and drive is long or if the motor is coasting at more than or equal to 200 Hz, do not use Speed Search to restart the motor. Use Short Circuit Braking.

■ Current Detection 2

Use this Speed Search function with induction motors. Set $b3-24 = 2$ [Speed Search Method Selection = Current Detection 2]. Current Detection Speed Search injects current into the motor to detect the speed of an induction motor. Speed Search increases the output voltage for the time set in $L2-04$ [Powerloss V/f Recovery Ramp Time], starting from the maximum output frequency or the frequency reference.

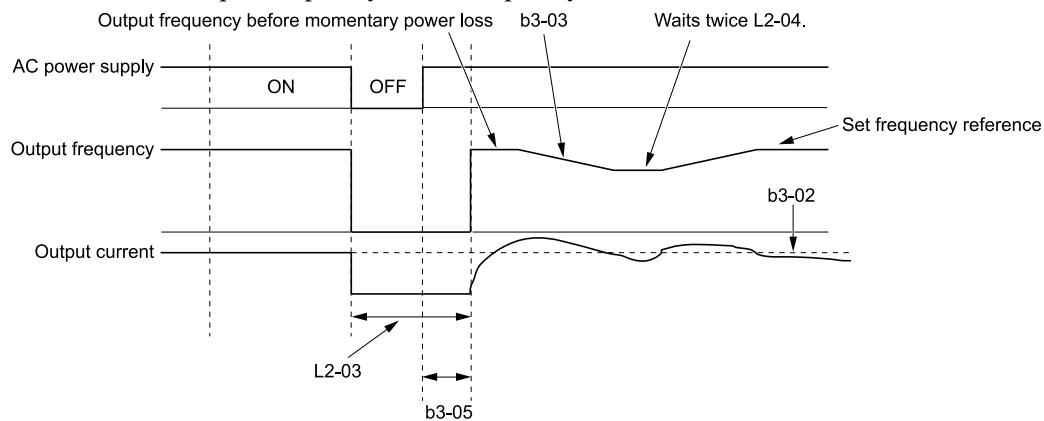

Figure 12.29 Current Detection 2 after Momentary Power Loss

Note:

After you restore power, the drive will not do Speed Search until the time set in $b3-05$ [Speed Search Delay Time] expires. This means that the drive will not always start Speed Search when the time set in $L2-03$ [Minimum Baseblock Time] expires.

If you enter the Run command at the same time as Speed Search, the drive will not do Speed Search until the time set in $L2-03$ expires. When the value set in $L2-03 < b3-05$, the drive will use the wait time set in $b3-05$.

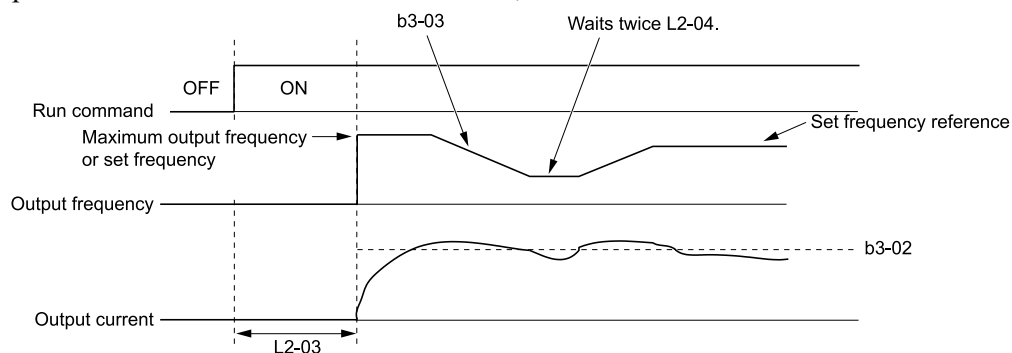

Figure 12.30 Speed Search Selection at Start (Current Detection Type)

WARNING! Sudden Movement Hazard. Do not do Current Detection Speed Search with light loads or a stopped motor. If you do Auto-Tuning in these conditions, the motor can suddenly accelerate and cause serious injury or death.

Note:

- You cannot use Current Detection Speed Search with PM motors.
- If the drive detects *oL1* [Motor Overload] during Current Detection Speed Search, decrease *b3-03*.
- If the drive detects *oC* [Overcurrent] or *ov* [Overvoltage] during Current Detection Speed Search after the drive recovers from a momentary power loss, increase *L2-03*.
- If *b3-01 = 1* [Speed Search at Start Selection = Enabled], too much current will flow when the motor starts. If there is too much current at start, it will decrease the service life of the drive IGBTs over time.

■ **Speed Estimation**

Use this Speed Search function with induction motors. Set *b3-24 = 1* [Speed Search Method Selection = Speed Estimation]. This function uses less current and has a shorter search time than other functions. This function lets you do Speed Search when the motor is rotating in reverse. When you return power after a power loss, the motor will not suddenly accelerate.

Note:

You cannot do Speed Estimation Speed Search in these conditions:

- When You Operate More than One Motor with One Drive
- When you use a high-speed motor (200 Hz or higher)
- When you use a 1.5 kW or smaller motor.
- When the motor output is more than 1 frame size smaller than the drive capacity
- When there is a long wiring distance between the drive and motor

For these conditions, use Current Detection Speed Search.

Speed Estimation Speed Search uses these two steps to estimate the motor speed:

1. Residual Voltage Search

When there is a short baseblock time, the drive searches for residual voltage. The drive uses the residual voltage in the motor to estimate the motor speed and direction of rotation. The drive outputs the estimated motor speed as frequency, then uses the deceleration rate set in *L2-04* to increase the voltage. When the output voltage aligns with the V/f pattern, the drive accelerates or decelerates the motor to the frequency reference. If the drive cannot estimate the motor speed because of low residual voltage, it will automatically do Current Injection.

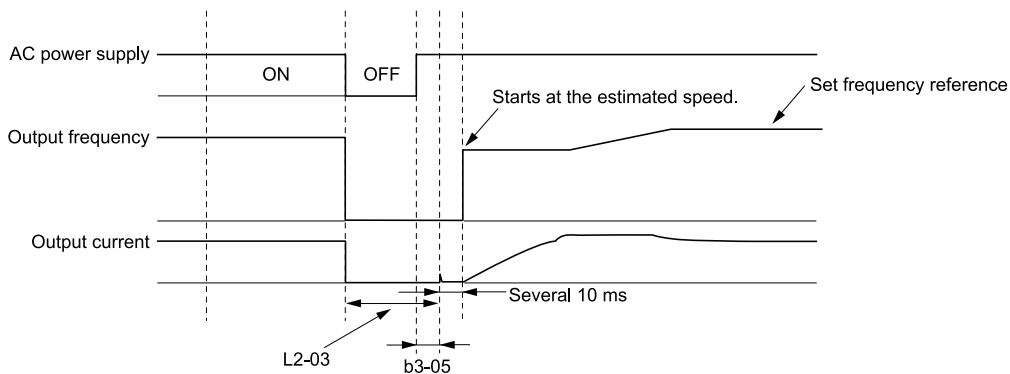

Figure 12.31 Speed Search after Baseblock

Note:

After you return power, the drive waits for the time set in *b3-05*. If power loss is longer than the time set in *L2-03*, the drive will start Speed Search when the time set in *b3-05* is expired after the power recovery.

2. Current Injection

If there is not sufficient residual voltage in the motor, the drive does Current Injection. The drive injects the quantity of DC current set in *b3-06* [Speed Estimation Current Level 1] into the motor windings to estimate the motor speed and direction of rotation. The drive outputs the estimated motor speed as frequency, then uses the deceleration rate set in *L2-04* to increase the voltage. When the output voltage aligns with the V/f pattern, the drive accelerates or decelerates the motor to the frequency reference.

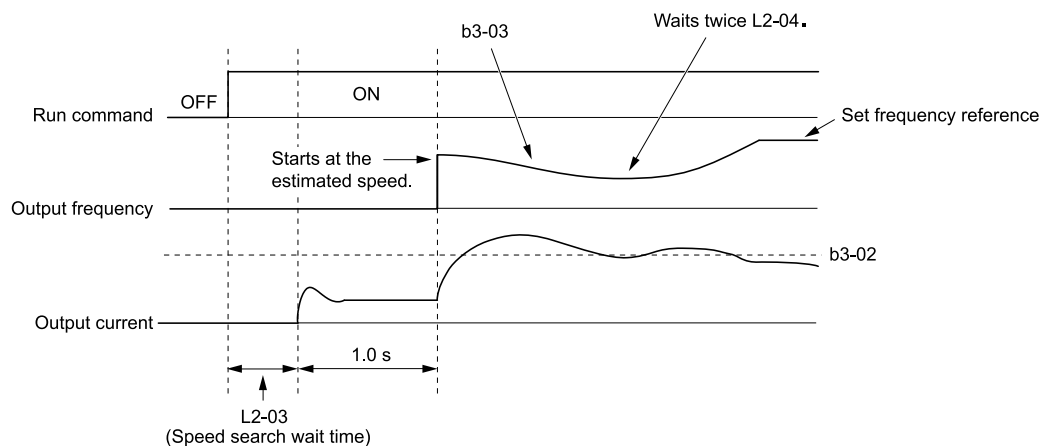

Figure 12.32 Speed Search Selection at Start

Note:

Set the lower limit of the delay time to *b3-05* for when Speed Search starts.

Speed Search and Operation Conditions

These conditions apply to Speed Search operation. When *A1-02 = 0, 1, 2* [Control Method Selection = *V/f Control, V/f Control with Encoder, Open Loop Vector*], set *b3-24* [Speed Search Method Selection] before you do Speed Search.

- Do Speed Search with each Run Command
The drive ignores a Speed Search command from the external terminals.
- Use an MFDI to do an External Speed Search Command
To use an MFDI to do Speed Search, input the Run command at the same time that terminal Sx set for Speed Search activates, or after Speed Search activates.
Set Speed Search to *H1-xx* to do the function externally. You cannot set external Speed Search 1 and 2 at the same time.

Table 12.27 Execute Speed Search via the Digital Input Terminals

H1-xx Setting	Name	Current Detection 2	Speed Estimation
61	Speed Search from Fmax	ON: Speed Search starts from <i>E1-04</i> [Maximum Output Frequency].	External Speed Search commands 1 and 2 work the same.
62	Speed Search from Fref	ON: Speed Search starts from the frequency reference immediately before you input the Speed Search command.	The drive estimates the motor speed, then starts Speed Search from the estimated speed.

- Do Speed Search with Each Auto Restart
Set *L5-01* [Number of Auto-Restart Attempts] = 1 or more. After an Auto Restart fault, the drive automatically does Speed Search.
- Do Speed Search after Momentary Power Loss
Set *L2-01 = 1, 2* [Power Loss Ride Through Select = Enabled for L2-02 Time, Enabled while CPU Power Active].
- Do Speed Search after You Clear the External Baseblock Command
If you clear the external baseblock command, the drive will do Speed Search in these conditions;
 - There is an active Run command
 - The output frequency is higher than the minimum frequency

b3-01: Speed Search at Start Selection

No. (Hex.)	Name	Description	Default (Range)
b3-01 (0191)	Speed Search at Start Selection	<div style="display: flex; gap: 5px;"> V/f CL-V/f OLV CLV AOLV OLV/PM AOLV/PM CLV/PM EZOLV </div> Sets the Speed Search at Start function so the drive will do Speed Search with each Run command.	Determined by <i>A1-02</i> (0, 1)

0 : Disabled

Enter a Run command to start to operate the drive at the minimum output frequency.

When the Run command is enabled and the *Speed Search from Fmax or Fref* [*H1-xx = 61, 62*] is input from a multi-function input terminal, the drive will do Speed Search and start to operate the motor.

1 : Enabled

Enter the Run command to do Speed Search. The drive completes Speed Search, then starts to operate the motor.

Note:

If you set $b3-01 = 1$ when $b3-24 = 2$ [*Speed Search Method Selection = Current Detection 2*], too much current flows at start. Too much current at start will decrease the service life of the drive IGBT.

■ b3-02: SpeedSearch Deactivation Current

No. (Hex.)	Name	Description	Default (Range)
b3-02 (0192)	SpeedSearch Deactivation Current	<div style="display: flex; justify-content: space-between; align-items: center;"> V/f CL-V/f OLV CLV AOLV OLV/PM AOLV/PM CLV/PM EZOLV </div> <p>Sets the current level that stops Speed Search as a percentage of the drive rated output current. Usually it is not necessary to change this setting.</p>	Determined by A1-02 (0 - 200%)

If the drive cannot restart the motor, decrease this setting.

■ b3-03: Speed Search Deceleration Time

No. (Hex.)	Name	Description	Default (Range)
b3-03 (0193)	Speed Search Deceleration Time	<div style="display: flex; justify-content: space-between; align-items: center;"> V/f CL-V/f OLV CLV AOLV OLV/PM AOLV/PM CLV/PM EZOLV </div> <p>Sets the deceleration time during Speed Search operation. Set the length of time to decelerate from the maximum output frequency to the minimum output frequency.</p>	2.0 s (0.1 - 10.0 s)

This is the output frequency deceleration time used by Current Detection Speed Search and by the Current Injection Method of Speed Estimation Speed Search.

Note:

- When $A1-02 = 8$ [*Control Method Selection = EZOLV*], this parameter takes effect only in Expert Mode.
- If the drive detects *oL1* [*Motor Overload*] during Current Detection Speed Search, decrease the value set in $b3-03$.

■ b3-04: V/f Gain during Speed Search

No. (Hex.)	Name	Description	Default (Range)
b3-04 (0194)	V/f Gain during Speed Search	<div style="display: flex; justify-content: space-between; align-items: center;"> V/f CL-V/f OLV CLV AOLV OLV/PM AOLV/PM CLV/PM EZOLV </div> <p>Sets the ratio used to reduce the V/f during searches to reduce the output current during speed searches.</p>	Determined by o2-04 (10 - 100)

Use this formula to calculate the output voltage during Speed Search:

Output voltage during Speed Search = Configured V/f × $b3-04$

When the current detection search operates correctly, this configuration is not necessary.

■ b3-05: Speed Search Delay Time

No. (Hex.)	Name	Description	Default (Range)
b3-05 (0195)	Speed Search Delay Time	<div style="display: flex; justify-content: space-between; align-items: center;"> V/f CL-V/f OLV CLV AOLV OLV/PM AOLV/PM CLV/PM EZOLV </div> <p>Sets the Speed Search delay time to activate a magnetic contactor installed between the drive and motor.</p>	0.2 s (0.0 - 100.0 s)

When you use a magnetic contactor between the drive and motor, you must close the contactor before the drive will do Speed Search. This parameter sets a delay time to activate the magnetic contactor.

■ b3-06: Speed Estimation Current Level 1

No. (Hex.)	Name	Description	Default (Range)
b3-06 (0196) Expert	Speed Estimation Current Level 1	<div style="display: flex; justify-content: space-between; align-items: center;"> V/f CL-V/f OLV CLV AOLV OLV/PM AOLV/PM CLV/PM EZOLV </div> <p>Sets the level of current that flows to the motor during Speed Estimation Speed Search as a coefficient of the motor rated current. Usually it is not necessary to change this setting.</p>	Determined by o2-04 (0.0 - 2.0)

When the speed estimation value is the minimum output frequency, increase this setting. You can do this when the motor coasts at a high speed while the drive estimates the speed during Speed Estimation Speed Search. The limit of the output current during speed search is automatically the drive rated current.

Note:

When the drive cannot accurately estimate the speed after you adjust this parameter, use Current Detection Speed Search.

■ b3-07: Speed Estimation Current Level 2

No. (Hex.)	Name	Description	Default (Range)
b3-07 (0197) Expert	Speed Estimation Current Level 2	<div style="display: flex; justify-content: space-between; align-items: center;"> V/f CL-V/f OLV CLV AOLV OLV/PM AOLV/PM CLV/PM EZOLV </div> <p>Sets the level of current that flows to the motor during Speed Estimation Speed Search as a coefficient of E2-03 [Motor No-Load Current] or E4-03 [Motor 2 Rated No-Load Current]. Usually it is not necessary to change this setting.</p>	1.0 (0.0 - 3.0)

During Speed Estimation Speed Searches, when the speed estimation value aligns with the minimum output frequency, increase the setting value in 0.1-unit increments. The limit of the output current during speed search is automatically the drive rated current.

■ b3-08: Speed Estimation ACR P Gain

No. (Hex.)	Name	Description	Default (Range)
b3-08 (0198) Expert	Speed Estimation ACR P Gain	<div style="display: flex; justify-content: space-between; align-items: center;"> V/f CL-V/f OLV CLV AOLV OLV/PM AOLV/PM CLV/PM EZOLV </div> <p>Sets the proportional gain for the automatic current regulator during Speed Estimation Speed Search. Also adjusts speed search responsiveness. Usually it is not necessary to change this setting.</p>	Determined by A1-02 and o2-04 (0.00 - 6.00)

■ b3-09: Speed Estimation ACR I Time

No. (Hex.)	Name	Description	Default (Range)
b3-09 (0199) Expert	Speed Estimation ACR I Time	<div style="display: flex; justify-content: space-between; align-items: center;"> V/f CL-V/f OLV CLV AOLV OLV/PM AOLV/PM CLV/PM EZOLV </div> <p>Sets the integral time for the automatic current regulator during Speed Estimation Speed Search. Also adjusts speed search responsiveness. Usually it is not necessary to change this setting.</p>	Determined by A1-02 (0.0 - 1000.0 ms)

■ b3-10: Speed Estimation Detection Gain

No. (Hex.)	Name	Description	Default (Range)
b3-10 (019A) Expert	Speed Estimation Detection Gain	<div style="display: flex; justify-content: space-between; align-items: center;"> V/f CL-V/f OLV CLV AOLV OLV/PM AOLV/PM CLV/PM EZOLV </div> <p>Sets the gain to correct estimated frequencies from Speed Estimation Speed Search.</p>	1.05 (1.00 - 1.20)

If the drive detects *ov* [DC Bus Overvoltage] when you restart the motor, increase the setting value.

■ b3-14: Bi-directional Speed Search

No. (Hex.)	Name	Description	Default (Range)
b3-14 (019E)	Bi-directional Speed Search	<div style="display: flex; justify-content: space-between; align-items: center;"> V/f CL-V/f OLV CLV AOLV OLV/PM AOLV/PM CLV/PM EZOLV </div> <p>Sets the direction of Speed Search to the direction of the frequency reference or in the motor rotation direction as detected by the drive.</p>	Determined by A1-02, b3-24, and E9-01 (0, 1)

Note:

- The initial value of b3-14 [Bi-directional Speed Search] is different for different A1-02 [Control Method Selection] settings when you set these parameters: Refer to [Parameters that Change from the Default Settings with A1-02 \[Control Method Selection\] on page 627](#) for information.
 - A1-02 = 0, 2, 8 [V/f, OLV, EZOLV]
 - E9-01 = 0 [Motor Type Selection = Induction (IM)]
 - b3-24 = 1 [Speed Search Method Selection = Speed Estimation].
- The initial value of b3-14 is 0 when you set these parameters:
 - A1-02 = 0, 2, 8
 - E9-01 = 0
 - b3-24 = 2 [Current Detection 2]
- The initial value of b3-14 is different for different A1-02 settings when you set these parameters: Refer to [Parameters that Change from the Default Settings with A1-02 \[Control Method Selection\] on page 627](#) for information.
 - A1-02 = 1, 4, 8 [CL-V/f, AOLV, EZOLV]
 - E9-01 = 1, 2 [Permanent Magnet (PM), Synchronous Reluctance (SynRM)]
- When you set A1-02, b3-24, and E9-01, set b3-14.

0 : Disabled

The drive uses the frequency reference to detect the direction of motor rotation.

1 : Enabled

The drive detects the direction of motor rotation during Speed Search.

■ **b3-17: Speed Est Retry Current Level**

No. (Hex.)	Name	Description	Default (Range)
b3-17 (01F0) Expert	Speed Est Retry Current Level	V/f CL-V/f OLV CLV AOLV OLV/PM AOLV/PM CLV/PM EZOLV Sets the current level for the search retry function in Speed Estimation Speed Search as a percentage where drive rated current is a setting value of 100%.	150% (0 - 200%)

When a large quantity of current flows during Speed Estimation Speed Search, the drive temporarily stops operation to prevent overvoltage and overcurrent. When the current is at the level set in *b3-17*, the drive tries speed search again.

■ **b3-18: Speed Est Retry Detection Time**

No. (Hex.)	Name	Description	Default (Range)
b3-18 (01F1) Expert	Speed Est Retry Detection Time	V/f CL-V/f OLV CLV AOLV OLV/PM AOLV/PM CLV/PM EZOLV Sets the length of time that the drive will wait to retry Speed Estimation Speed Search when too much current flow stopped the Speed Search.	0.10 s (0.00 - 1.00 s)

When the current is more than the level set in *b3-17* [*Speed Est Retry Current Level*] during the time set in *b3-18*, the drive tries speed search again.

■ **b3-19: Speed Search Restart Attempts**

No. (Hex.)	Name	Description	Default (Range)
b3-19 (01F2)	Speed Search Restart Attempts	V/f CL-V/f OLV CLV AOLV OLV/PM AOLV/PM CLV/PM EZOLV Sets the number of times to restart Speed Search if Speed Search does not complete.	3 times (0 - 10 times)

If the drive does the number of Speed Search restarts set in this parameter, it will trigger an *SEr* [*Speed Search Retries Exceeded*] error.

■ **b3-24: Speed Search Method Selection**

No. (Hex.)	Name	Description	Default (Range)
b3-24 (01C0)	Speed Search Method Selection	V/f CL-V/f OLV CLV AOLV OLV/PM AOLV/PM CLV/PM EZOLV Sets the Speed Search method when you start the motor or when you restore power after a momentary power loss.	Determined by A1-02 (1, 2)

Note:

- When *A1-02* = 8 [*Control Method Selection* = *EZOLV*], the default setting changes when the setting for *E9-01* [*Motor Type Selection*] and the drive model change.
 - *E9-01* = 0 [*Induction (IM)*]
– 2004 - 2313, 4002 - 4296: 1
 - 2360, 2415, 4371 - 4H12: 2
 - *E9-01* = 1, 2 [*Permanent Magnet (PM)*, *Synchronous Reluctance (SynRM)*]: 1
- When you set *A1-02* = 8 and *E9-01* = 1 or 2, also set *b3-24* = 1. If *b3-24* = 2, the drive will detect *oPE08* [*Parameter Selection Error*].
- When you set *b3-24*, it will trigger the drive to initialize *b3-14* [*Bi-directional Speed Search*]. After you set *b3-24*, set *b3-14*.
- When *A1-02* = 4 [*AOLV*], the default setting is 1 [*Speed Estimation*].

Set *b3-01* = 1 [*Speed Search at Start Selection* = *Enabled*] to do Speed Search at start. Set *L2-01* = 1 [*Power Loss Ride Through Select* = *Enabled for L2-02 Time*] to do Speed Search after you restore power after a momentary power loss.

1 : Speed Estimation

The drive uses the residual voltage from a short baseblock time to estimate the motor speed.

If there is not sufficient residual voltage, then the drive will inject DC current into the motor to estimate the motor speed.

2 : Current Detection 2

The drive will inject DC current into the motor to estimate motor speed.

■ b3-25: Speed Search Wait Time

No. (Hex.)	Name	Description	Default (Range)
b3-25 (01C8) Expert	Speed Search Wait Time	<input type="checkbox"/> V/f <input type="checkbox"/> CL-V/f <input type="checkbox"/> OLV <input type="checkbox"/> CLV <input type="checkbox"/> AOLV <input checked="" type="checkbox"/> OLV/PM <input type="checkbox"/> AOLV/PM <input type="checkbox"/> CLV/PM <input type="checkbox"/> EZOLV Sets the length of time the drive will wait to start the Speed Search Retry function.	0.5 s (0.0 - 30.0 s)

If the drive detects these faults during speed search, increase the setting value:

- *oC* [Overcurrent]
- *ov* [Overvoltage]
- *SEr* [Speed Search Retries Exceeded]

■ b3-26: Direction Determination Level

No. (Hex.)	Name	Description	Default (Range)
b3-26 (01C7) Expert	Direction Determination Level	<input type="checkbox"/> V/f <input type="checkbox"/> CL-V/f <input type="checkbox"/> OLV <input type="checkbox"/> CLV <input type="checkbox"/> AOLV <input checked="" type="checkbox"/> OLV/PM <input type="checkbox"/> AOLV/PM <input type="checkbox"/> CLV/PM <input type="checkbox"/> EZOLV Sets the level to find the motor rotation direction. Increase the value if the drive cannot find the direction.	1000 (40 to 60000)

■ b3-27: Speed Search RUN/BB Priority

No. (Hex.)	Name	Description	Default (Range)
b3-27 (01C9) Expert	Speed Search RUN/BB Priority	<input type="checkbox"/> V/f <input type="checkbox"/> CL-V/f <input type="checkbox"/> OLV <input type="checkbox"/> CLV <input type="checkbox"/> AOLV <input checked="" type="checkbox"/> OLV/PM <input type="checkbox"/> AOLV/PM <input type="checkbox"/> CLV/PM <input type="checkbox"/> EZOLV Sets the conditions necessary to start Speed Search.	0 (0, 1)

Executes *Speed Search from Fmax or Fref* [$H1-xx = 61/62$] for initial speed searches or from the MFDI terminal.

0 : SS Only if RUN Applied Before BB

1 : SS Regardless of RUN/BB Sequence

■ b3-29: Speed Search Back-EMF Threshold

No. (Hex.)	Name	Description	Default (Range)
b3-29 (077C) Expert	Speed Search Back-EMF Threshold	<input type="checkbox"/> V/f <input type="checkbox"/> CL-V/f <input type="checkbox"/> OLV <input type="checkbox"/> CLV <input type="checkbox"/> AOLV <input checked="" type="checkbox"/> OLV/PM <input type="checkbox"/> AOLV/PM <input type="checkbox"/> CLV/PM <input type="checkbox"/> EZOLV Sets the induced voltage for motors that use Speed Search. The drive will start Speed Search when the motor induced voltage level is the same as the setting value. Usually it is not necessary to change this setting.	10% (0 - 10%)

To make adjustments, gradually decrease the setting value. If you decrease the setting value too much, speed search will not operate correctly.

■ b3-31: Spd Search Current Reference Lvl

No. (Hex.)	Name	Description	Default (Range)
b3-31 (0BC0) Expert	Spd Search Current Reference Lvl	<input type="checkbox"/> V/f <input type="checkbox"/> CL-V/f <input type="checkbox"/> OLV <input type="checkbox"/> CLV <input type="checkbox"/> AOLV <input checked="" type="checkbox"/> OLV/PM <input type="checkbox"/> AOLV/PM <input type="checkbox"/> CLV/PM <input type="checkbox"/> EZOLV Sets the current level that decreases the output current during Current Detection Speed Search.	1.50 (1.50 - 3.50)

Set this parameter as a ratio of *E2-03* [Motor No-Load Current]. The setting is a ratio with respect to 30% of the motor rated current when $E2-03 \leq E2-01$ [Motor Rated Current (FLA)] $\times 0.3$.

Note:

When $A1-02 = 8$ [Control Method Selection = EZOLV], the setting is a ratio with respect to $E9-06$ [Motor Rated Current (FLA)] $\times 0.5$.

■ b3-32: Spd Search Current Complete Lvl

No. (Hex.)	Name	Description	Default (Range)
b3-32 (0BC1) Expert	Spd Search Current Complete Lvl	<input type="checkbox"/> V/f <input type="checkbox"/> CL-V/f <input type="checkbox"/> OLV <input type="checkbox"/> CLV <input type="checkbox"/> AOLV <input checked="" type="checkbox"/> OLV/PM <input type="checkbox"/> AOLV/PM <input type="checkbox"/> CLV/PM <input type="checkbox"/> EZOLV Sets the current level that completes Speed Search.	1.20 (0.00 - 1.49)

12.3 b: Application

The Current Detection Speed Search gradually decreases the output frequency to search for the motor speed when the output current is equal to or less than Speed Search Current Complete Level.

Set this parameter as a ratio of $E2-03$ [Motor No-Load Current]. The setting is a ratio with respect to 30% of the motor rated current when $E2-03 \leq E2-01$ [Motor Rated Current (FLA)] $\times 0.3$.

Note:

When $A1-02 = 8$ [Control Method Selection = EZOLV], the setting is a ratio with respect to $E9-06$ [Motor Rated Current (FLA)] $\times 0.5$.

■ b3-33: Speed Search during Uv Selection

No. (Hex.)	Name	Description	Default (Range)
b3-33 (0B3F) Expert	Speed Search during Uv Selection	<div style="display: flex; justify-content: space-between; align-items: center;"> V/f CL-V/f OLV CLV AOLV OLV/PM AOLV/PM CLV/PM EZOLV </div> <p>Sets the function that starts Speed Search at start-up if the drive detects a Uv [Undervoltage] when it receives a Run command.</p>	1 (0, 1)

Set these three parameters as shown to enable b3-33:

- $L2-01 = 1, 2$ [Power Loss Ride Through Select = Enabled for L2-02 Time, Enabled while CPU Power Active]
- $b3-01 = 1$ [Speed Search at Start Selection = Enabled]
- $b1-03 = 1$ [Stopping Method Selection = Coast to Stop]

0 : Disabled

1 : Enabled

■ b3-35: Low Back EMF Detection Level

No. (Hex.)	Name	Description	Default (Range)
b3-35 (0BC3) Expert	Low Back EMF Detection Level	<div style="display: flex; justify-content: space-between; align-items: center;"> V/f CL-V/f OLV CLV AOLV OLV/PM AOLV/PM CLV/PM EZOLV </div> <p>Sets the Low Back EMF Detection Level. Usually it is not necessary to change this setting.</p>	10% (5 - 50%)

■ b3-36: High Back EMF Detection Level

No. (Hex.)	Name	Description	Default (Range)
b3-36 (0BC4) Expert	High Back EMF Detection Level	<div style="display: flex; justify-content: space-between; align-items: center;"> V/f CL-V/f OLV CLV AOLV OLV/PM AOLV/PM CLV/PM EZOLV </div> <p>Sets the voltage level for Speed Search restart. Usually it is not necessary to change this setting.</p>	0.970 (0.500 - 1.000)

The drives wait for Speed Search to prevent failure when the induced voltage for the motor during coasting to a stop is larger than the voltage the drive can output. The drive will not restart the motor (Speed Search) if induced voltage \geq supply voltage $\times b3-36$ after a Run command is entered. The drive will restart the motor when induced voltage $<$ supply voltage $\times b3-36$. For example, if the setting value is 0.83 and the voltage does not decrease to the induced voltage at approximately 183 V when the power supply voltage is 220 V, the drive will not restart.

■ b3-39: Regen Judgment Lv of Spd Search

No. (Hex.)	Name	Description	Default (Range)
b3-39 (1B8F) Expert	Regen Judgment Lv of Spd Search	<div style="display: flex; justify-content: space-between; align-items: center;"> V/f CL-V/f OLV CLV AOLV OLV/PM AOLV/PM CLV/PM EZOLV </div> <p>Sets the level to determine the regenerative state during speed search. Usually it is not necessary to change this setting.</p>	15% (0 - 50%)

If the speed search is not completed after starting the speed search, increase the setting value in 5% increments after the drive stops.

If the drive detects ov [Overvoltage] during speed search, decrease the setting value in 5% increments after the drive stops.

■ b3-54: Search Time

No. (Hex.)	Name	Description	Default (Range)
b3-54 (3123)	Search Time	<div style="display: flex; justify-content: space-between; align-items: center;"> V/f CL-V/f OLV CLV AOLV OLV/PM AOLV/PM CLV/PM EZOLV </div> <p>Sets the length of time that the drive will run Speed Search.</p>	400 ms (10 - 2000 ms)

If you set this parameter too low, Speed Search will not operate correctly.

If the drive detects *oC* [Overcurrent] immediately after Speed Search Starts:

- Increase the value of *L2-03* [Minimum Baseblock Time] and decrease the motor speed you use to start Speed Search.
- Increases the setting value of *b3-08* [Speed Estimation ACR P Gain].
- Increase the value of *b3-54*.

If the drive detects *oC* or *ov* [DC Bus Overvoltage] during Speed Search, increase the value of *b3-08*.

■ b3-55: Current Increment Time

No. (Hex.)	Name	Description	Default (Range)
b3-55 (3124) Expert	Current Increment Time	<input type="checkbox"/> V/f <input type="checkbox"/> CL-V/f <input type="checkbox"/> OLV <input type="checkbox"/> CLV <input type="checkbox"/> AOLV <input type="checkbox"/> OLV/PM <input type="checkbox"/> AOLV/PM <input type="checkbox"/> CLV/PM <input checked="" type="checkbox"/> EZOLV Sets the length of time that the drive will increase the current from zero current to the setting value of <i>b3-06</i> [Speed Estimation Current Level 1].	10 ms (10 - 2000 ms)

Gradually increase the setting value when a large quantity of current flows after speed search starts. If you set this value too high, speed search will not operate correctly.

■ b3-56: InverseRotationSearch WaitTime

No. (Hex.)	Name	Description	Default (Range)
b3-56 (3126)	InverseRotationSearch WaitTime	<input type="checkbox"/> V/f <input type="checkbox"/> CL-V/f <input checked="" type="checkbox"/> OLV <input type="checkbox"/> CLV <input type="checkbox"/> AOLV <input type="checkbox"/> OLV/PM <input type="checkbox"/> AOLV/PM <input type="checkbox"/> CLV/PM <input checked="" type="checkbox"/> EZOLV Sets the wait time until the drive starts inverse rotation search after it completes forward search when you do inverse rotation search during Current Detection Speed Search.	Determined by <i>o2-04</i> (0.1 - 5.0 s)

■ b3-61: Initial Pole Detection Gain

No. (Hex.)	Name	Description	Default (Range)
b3-61 (1B96) Expert	Init Magnet Pole Estimation Gain	<input type="checkbox"/> V/f <input type="checkbox"/> CL-V/f <input type="checkbox"/> OLV <input type="checkbox"/> CLV <input type="checkbox"/> AOLV <input type="checkbox"/> OLV/PM <input checked="" type="checkbox"/> AOLV/PM <input type="checkbox"/> CLV/PM <input checked="" type="checkbox"/> EZOLV Sets the responsiveness for initial motor magnetic pole calculation when <i>A1-02</i> = 6 [Control Method Selection = AOLV/PM]. Set <i>b3-61</i> > 0.0 for an ordinary IPM motor.	5.0 (-20.0 - +20.0)

Note:

- Set *n8-35* = 1 [Initial Pole Calculation Method = High Frequency Injection] to enable this parameter.
- The drive automatically calculates this value when High Frequency Injection Auto-Tuning completes successfully.

Used when *n8-35* = 1 [Initial Pole Detection Method = High Frequency Injection]. Sets the responsiveness for initial motor magnetic pole calculation. Set this parameter to a positive value for an ordinary motor. When you use High Frequency Injection Tuning, it will automatically set this parameter.

◆ b4: Timer Function

The drive uses timers to delay activating and deactivating MFDO terminals.

Timers prevent sensors and switches from making chattering noise.

There are two types of timers:

- Timers that set a delay for timer inputs and timer outputs.
These timers delay activating and deactivating of the MFDIs and MFDOs.
To enable this function, set *H1-xx* = 18 [MFDI Function Select = Timer Function], and set *H2-01* to *H2-03* = 12 [MFDO Function Select = Timer Output].
- Timers that set a delay to activate and deactivate MFDO terminals.
These timers delay activating and deactivating MFDO terminals.
To enable this function, set delay times in parameters *b4-03* to *b4-08*.

■ Timer Function Operation

- Timers that Set a Delay for Timer Inputs and Timer Outputs
Triggers timer output if the timer input is active for longer than the time set in *b4-01* [Timer Function ON-Delay Time]. Triggers timer output late for the time set in *b4-02* [Timer Function OFF-Delay Time]. Figure 12.33 shows an example of how the timer function works.

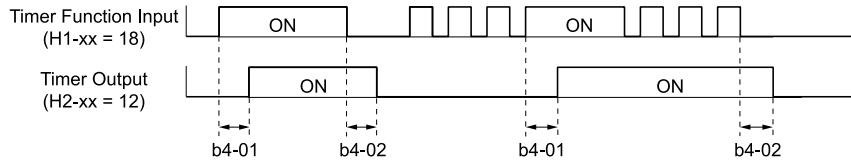

Figure 12.33 Example of Timer Function Operation

• Setting On/Off-delay Time for MFDO

Figure 12.34 uses H2-01 terminals to show an example of how the timer function works. Use b4-03 [Terminal M1-M2 ON-Delay Time] and b4-04 [Terminal M1-M2 OFF-Delay Time] to set this function.

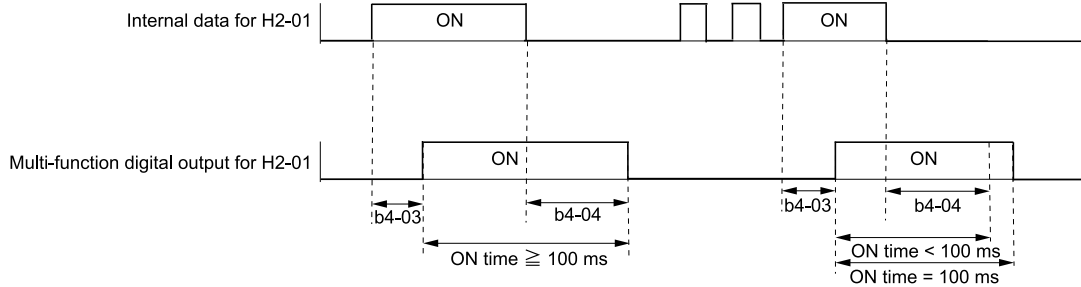

Figure 12.34 Example of How the Timer Function Works with H2-01 Terminals

Note:

When the terminal is triggered, it continues for a minimum of 100 ms. The on/off-delay time of MFDO terminal does not have an effect.

■ b4-01: Timer Function ON-Delay Time

No. (Hex.)	Name	Description	Default (Range)
b4-01 (01A3)	Timer Function ON-Delay Time	V/f CL-V/f OLV CLV AOLV OLV/PM AOLV/PM CLV/PM EZOLV Sets the ON-delay time for the timer input.	0.0 s (0.0 - 3000.0 s)

■ b4-02: Timer Function OFF-Delay Time

No. (Hex.)	Name	Description	Default (Range)
b4-02 (01A4)	Timer Function OFF-Delay Time	V/f CL-V/f OLV CLV AOLV OLV/PM AOLV/PM CLV/PM EZOLV Sets the OFF-delay time for the timer input.	0.0 s (0.0 - 3000.0 s)

■ b4-03: Terminal M1-M2 ON-Delay Time

No. (Hex.)	Name	Description	Default (Range)
b4-03 (0B30) Expert	Terminal M1-M2 ON-Delay Time	V/f CL-V/f OLV CLV AOLV OLV/PM AOLV/PM CLV/PM EZOLV Sets the delay time to activate the contact after the function set in H2-01 activates.	0 ms (0 - 65000 ms)

■ b4-04: Terminal M1-M2 OFF-Delay Time

No. (Hex.)	Name	Description	Default (Range)
b4-04 (0B31) Expert	Terminal M1-M2 OFF-Delay Time	V/f CL-V/f OLV CLV AOLV OLV/PM AOLV/PM CLV/PM EZOLV Sets the delay time to deactivate the contact after the function set in H2-01 deactivates.	0 ms (0 - 65000 ms)

■ b4-05: Terminal M3-M4 ON-Delay Time

No. (Hex.)	Name	Description	Default (Range)
b4-05 (0B32) Expert	Terminal M3-M4 ON-Delay Time	V/f CL-V/f OLV CLV AOLV OLV/PM AOLV/PM CLV/PM EZOLV Sets the delay time to activate the contact after the function set in H2-02 activates.	0 ms (0 - 65000 ms)

■ b4-06: Terminal M3-M4 OFF-Delay Time

No. (Hex.)	Name	Description	Default (Range)
b4-06 (0B33) Expert	Terminal M3-M4 OFF-Delay Time	V/f CL-V/f OLV CLV AOLV OLV/PM AOLV/PM CLV/PM EZOLV Sets the delay time to deactivate the contact after the function set in <i>H2-02</i> deactivates.	0 ms (0 - 65000 ms)

■ b4-07: Terminal M5-M6 ON-Delay Time

No. (Hex.)	Name	Description	Default (Range)
b4-07 (0B34) Expert	Terminal M5-M6 ON-Delay Time	V/f CL-V/f OLV CLV AOLV OLV/PM AOLV/PM CLV/PM EZOLV Sets the delay time to activate the contact after the function set in <i>H2-03</i> activates.	0 ms (0 - 65000 ms)

■ b4-08: Terminal M5-M6 OFF-Delay Time

No. (Hex.)	Name	Description	Default (Range)
b4-08 (0B35) Expert	Terminal M5-M6 OFF-Delay Time	V/f CL-V/f OLV CLV AOLV OLV/PM AOLV/PM CLV/PM EZOLV Sets the delay time to deactivate the contact after the function set in <i>H2-03</i> deactivates.	0 ms (0 - 65000 ms)

◆ b5: PID control

The drive has a PID control function. You can control drive output to adjust the proportional gain, integral time, and derivative time that has an effect on the bias between the target value and the feedback value to match the target value to the detected value. Use this function to adjust the drive output to accurately match the flow, pressure, and temperature in the application match the target value.

Use a combination of controls to increase the performance:

- P control
P control has a proportional effect on the deviation. It outputs the product (the controlled output) proportional to the deviation. You cannot use only the offset from P control to get to zero deviation.
- I control
I control is the integral of the deviation. It uses an integral value of the deviation to output the product (the controlled output). I control helps align the feedback value and the target value. If you use only a proportional effect (P control), it will cause an offset. Use a proportional effect with integral control, and the offset will disappear over time.
- D control
D control is the derivative of the deviation. D control has an effect on drive output when there are sudden, large changes in the deviation or feedback value. It quickly returns drive output to the value before the sudden change. It multiplies a time constant by a derivative value of the deviation (slope of the deviation), and adds that result to PID input to calculate the deviation of the signal, then it corrects the deviation.

Note:

D control causes less stable operation because the noise changes the deviation signal. Use D control only when necessary.

■ PID Control Operation

Figure 12.35 shows PID control operation. The modified output (output frequency) changes when the drive uses PID control to keep the deviation (the difference between the target value and the feedback value) constant.

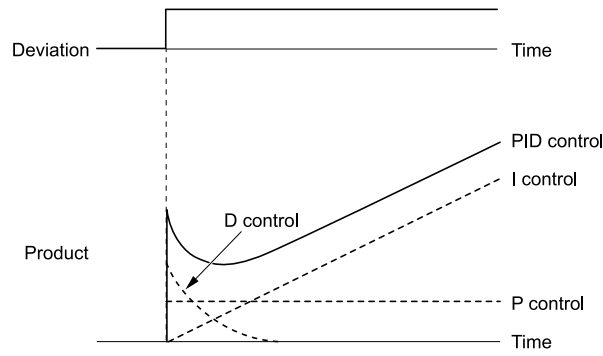

Figure 12.35 PID Control Operation

■ PID Control Applications

Table 12.28 shows applications for PID control.

Table 12.28 PID Control Applications

Application	Control Content	Sensors Used
Speed Control	<ul style="list-style-type: none"> The drive uses a feedback signal for the machine speed, and adjusts that speed to align with the target value. The drive uses speed data from other machinery as the target value to do synchronous control. The drive then adds that target value to the feedback from the machine it is operating to align its speed with the other machinery. 	Tacho generator
Pressure control	The drive uses feedback from the actual pressure to hold constant pressure.	Pressure sensor
Flow control	The drive uses feedback from the actual flow to hold constant flow.	Flow rate sensor
Temperature control	The drive uses feedback from the actual temperature to control a fan and hold constant temperature.	Thermocoupler, thermistor

■ Input Methods for the PID Setpoint

Use *b5-01 [PID Mode Setting]* to select how the PID setpoint is input to the drive.

When *b5-01 = 1 or 2 [Standard or Standard (D on feedback)]*, either the frequency reference set in *b1-01 [Frequency Reference Selection 1]* or *b1-15 [Frequency Reference Selection 2]* will be the PID setpoint, or the one of the inputs in Table 12.29 will be the PID setpoint.

When *b5-01 = 3 or 4 [Fref + PID Trim or Fref + PID Trim (D on feedback)]*, one of the inputs in Table 12.29 will be the PID setpoint.

Table 12.29 Input Methods for the PID Setpoint

Input Methods for the PID Setpoint	Setting Value
MFAI terminal A1	Set <i>H3-02 = C [Terminal A1 Function Selection = PID Setpoint]</i> .
MFAI terminal A2	Set <i>H3-10 [Terminal A2 Function Selection] = C</i> .
MFAI terminal A3	Set <i>H3-06 [Terminal A3 Function Selection] = C</i> .
MEMOBUS/Modbus register 0006H	Sets MEMOBUS/Modbus register 000FH (Control Selection Setting) bit 1 to 1 (PID setpoint input). Enters the PID setpoint to MEMOBUS/Modbus register 0006H (PID Target, 0.01% units, signed).
Pulse train input terminal RP	Set <i>H6-01 = 2 [Terminal RP Pulse Train Function = PID Setpoint Value]</i> .
<i>b5-19 [PID Setpoint Value]</i>	Set <i>b5-18 = 1 [b5-19 PID Setpoint Selection = Enabled]</i> . Enters the PID setpoint to <i>b5-19</i> .

Note:

If you set two inputs for the PID setpoint, it will trigger operation error *oPE07 [Analog Input Selection Error]*.

■ Entering the PID Feedback Value

You can use two methods to input the PID feedback value to the drive.

- Use Single Feedback Signal
Use Table 12.30 to select how the feedback signal is input to the drive for PID control.

Table 12.30 PID Feedback Input Method

PID Feedback Input Method	Setting Value
MFAI terminal A1	Set H3-02 = B [PID Feedback].
MFAI terminal A2	Set H3-10 = B.
MFAI terminal A3	Set H3-06 = B.
Pulse train input terminal RP	Set H6-01 = 1 [PID Feedback Value].

- Use Two Feedback Signals and Calculate the Deviation from the Difference between Those Signals Use Table 12.31 to select how the second feedback value is input to the drive. The drive calculates the deviation of the second feedback value. Set H3-02, H3-06, or H3-10 = 16 [Terminal A1/A3/A2 Function Selection = Differential PID Feedback] to enable the second feedback signal used to calculated the deviation.

Table 12.31 PID Differential Feedback Input Method

PID Differential Feedback Input Method	Setting Value
MFAI terminal A1	Set H3-02 = 16 [Differential PID Feedback].
MFAI terminal A2	Set H3-10 = 16.
MFAI terminal A3	Set H3-06 = 16.

Note:

If you set two or more of H3-02, H3-06, and H3-10 to 16, it will trigger oPE07 [Analog Input Selection Error].

PID Control Block Diagram

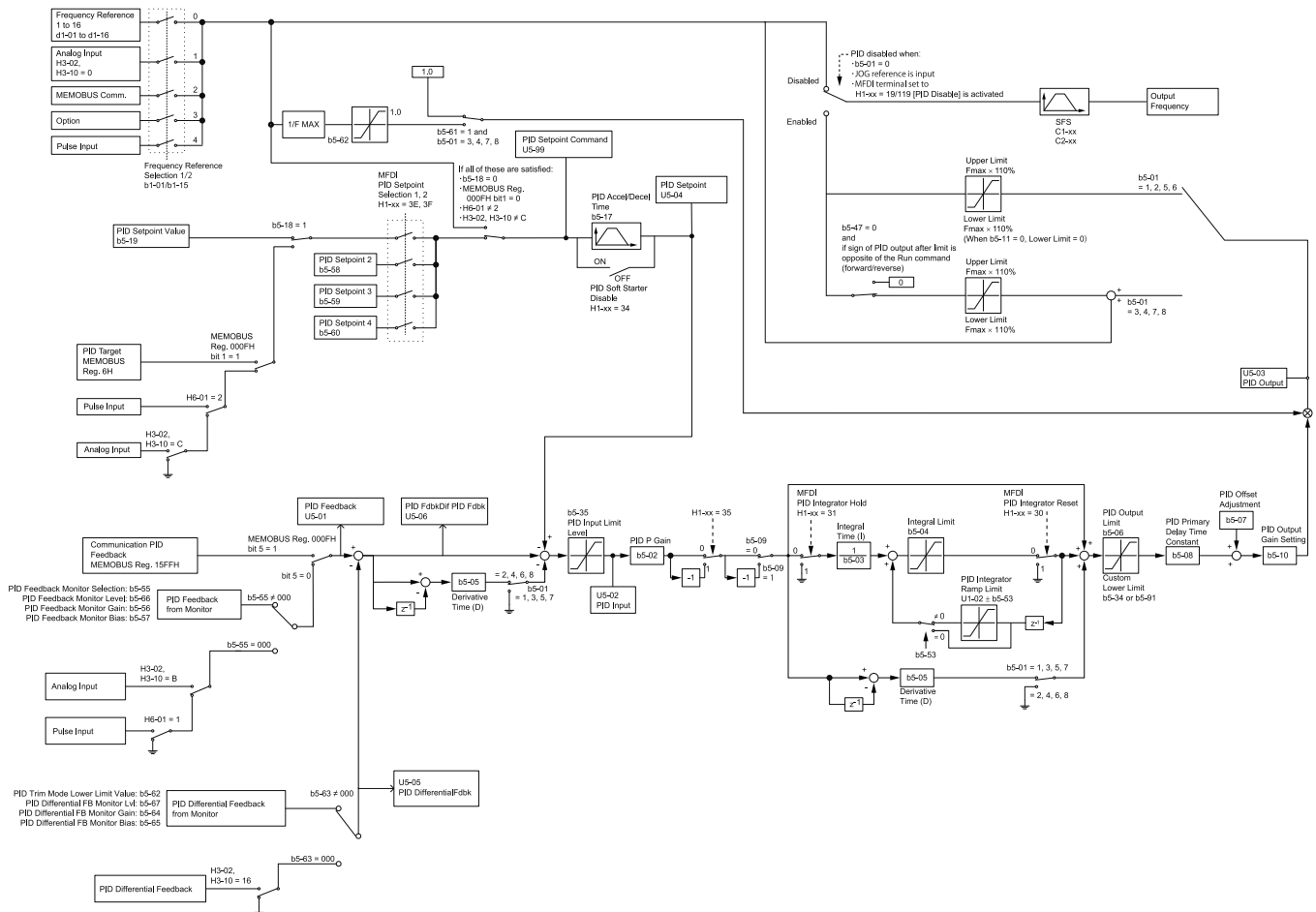

Figure 12.36 PID Control Block Diagram

PID Feedback Loss Detection

The PID feedback loss detection function detects broken sensors and defective wiring between the drive and sensors.

Use the PID feedback loss detection function when you use PID control. If the feedback signal is too low, the motor can suddenly accelerate to the maximum output frequency. This function prevents such risks to the load.

The drive uses two methods to detect feedback loss:

- *PID Feedback Loss [FbL]*

Set these parameters for the PID feedback loss detection function.

The drive detects feedback loss when the feedback value is less than the value in *b5-13* for longer than the time in *b5-14*.

- *b5-12 [Feedback Loss Detection Select]*
- *b5-13 [PID Feedback Loss Detection Lvl]*
- *b5-14 [PID Feedback Loss Detection Time]*

- *Excessive PID Feedback [FbH]*

Set these parameters to set how the drive detects a feedback level that is too high.

The drive detects too much PID feedback when the feedback value is more than the value in *b5-36* for longer than the time in *b5-37*.

- *b5-12 [Feedback Loss Detection Select]*
- *b5-36 [PID High Feedback Detection Lvl]*
- *b5-37 [PID High Feedback Detection Time]*

Figure 12.37 shows the operation principle when the feedback value is too low, and the drive detects feedback loss. The operation is the same when the drive detects too much feedback.

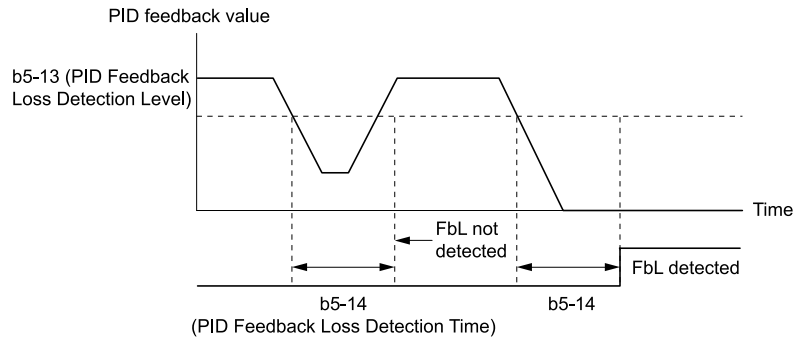

Figure 12.37 Time Chart for PID Feedback Loss Detection Time

■ PID Sleep

PID sleep stops drive operation when the PID output or the frequency reference is less than *b5-15 [PID Sleep Function Start Level]*. This function shuts off drive output after the motor decelerates to the set frequency.

The drive will automatically restart the motor when the PID output or the frequency reference is more than the *b5-15* value for the time set in *b5-16 [PID Sleep Delay Time]*.

Figure 12.38 shows the PID Sleep function.

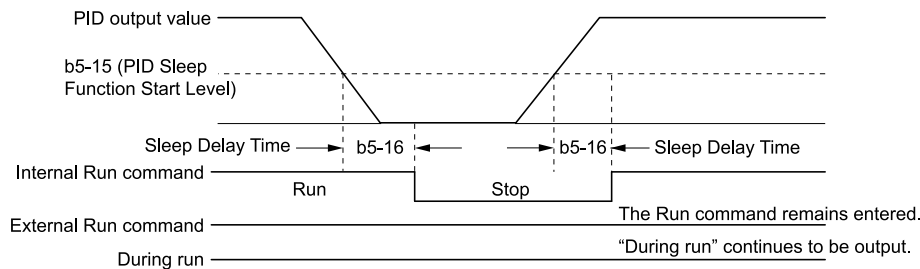

Figure 12.38 PID Sleep Time Chart

Note:

- The PID Sleep function is enabled when PID control is disabled.
- When the PID Sleep function is triggered, the drive will stop the motor as specified by *b1-03 [Stopping Method Selection]*.

■ Fine-Tuning PID

Fine-tune the following parameter settings to have PID control eliminate problems with overshoot and oscillation.

- *b5-02 [Proportional Gain (P)]*
- *b5-03 [Integral Time (I)]*
- *b5-05 [Derivative Time (D)]*

• *b5-08 [PID Primary Delay Time Constant]*

Purpose	Procedure	Results
Prevent overshoot.	<ul style="list-style-type: none"> Set <i>b5-05 [Derivative Time (D)]</i> to a smaller value. Set <i>b5-03 [Integral Time (I)]</i> to a larger value. 	
Quickly stabilize control.	<ul style="list-style-type: none"> Set <i>b5-05 [Derivative Time (D)]</i> to a larger value. Set <i>b5-03 [Integral Time (I)]</i> to a smaller value. 	
Prevent long-cycle oscillations.	Set <i>b5-03 [Integral Time (I)]</i> to a larger value.	
Prevent short-cycle oscillations.	<ul style="list-style-type: none"> Set <i>b5-05 [Derivative Time (D)]</i> to a smaller value. If you set <i>b5-05 = 0.00 [Derivative Time (D) = disabling D control]</i> and it does not stop oscillation, then set <i>b5-02 [Proportional Gain (P)]</i> to a smaller value or set <i>b5-08 [PID Primary Delay Time Constant]</i> to a larger value. 	

■ EZ Sleep/Wake-up Functionality

Set *b5-89 = 1 [Sleep Method Selection = EZ Sleep/Wake-up]* to enable the EZ Sleep/Wake-up function.

Note:

- When *b5-89 = 0 [Sleep Mode Selection = Standard]*, the EZ Sleep function and related parameters are disabled. Parameter *b5-91 [EZ Sleep Minimum Speed]* is not included in this rule.
- Set *b5-89 = 1* to disable *b5-15 [PID Sleep Function Start Level]*.

Setting Parameter	Description
<i>b5-90 [EZ Sleep Unit]</i>	<p>This parameter sets the unit of measure for <i>b5-92 [EZ Sleep Level]</i>. When <i>b5-90 = 0 [0.1Hz units]</i>, the setting range of <i>b5-91 [EZ Sleep Minimum Speed]</i> is 0.0 to 590.0 Hz. When <i>b5-90 = 1 [rev/min]</i>, the setting range is 0 to 35400 min⁻¹ (r/min).</p> <p>Note: When you change <i>b5-90</i>, the value of <i>b5-92</i> is not automatically updated.</p>
<i>b5-91 [EZ Sleep Minimum Speed]</i>	<p>Sets the output lower limit level for the PID control as Hz units or min⁻¹ (r/min) units.</p> <p>When you use <i>b5-91</i>, set <i>b5-34 = 0.0 [PID Output Lower Limit Level = 0.0 (disabled)]</i>. When you set the lower limit for PID output as a percentage of the Maximum Output Frequency, refer to page 717. The <i>b5-89</i> setting does not have an effect.</p>

12.3 b: Application

Setting Parameter	Description
<i>b5-92</i> [EZ Sleep Level]	When the output frequency or motor speed is less than the value of <i>b5-92</i> for longer than the value of <i>b5-93</i> [EZ Sleep Time], the drive does to sleep.
<i>b5-95</i> = 0 [EZ Sleep Wake-up Mode = Absolute]	When the PID feedback is less than the value of <i>b5-94</i> [EZ Sleep Wake-up Level] for longer than the time set in <i>b5-96</i> [EZ Sleep Wake-up Time], the drive restarts operation from sleep.
<i>b5-95</i> = 1 [EZ Sleep Wake-up Mode = Setpoint Delta]	The drive resumes operation from the sleep state when the PID feedback has dropped below the value defined as the PID setpoint value minus <i>b5-94</i> continuously for the time configured with <i>b5-96</i> .

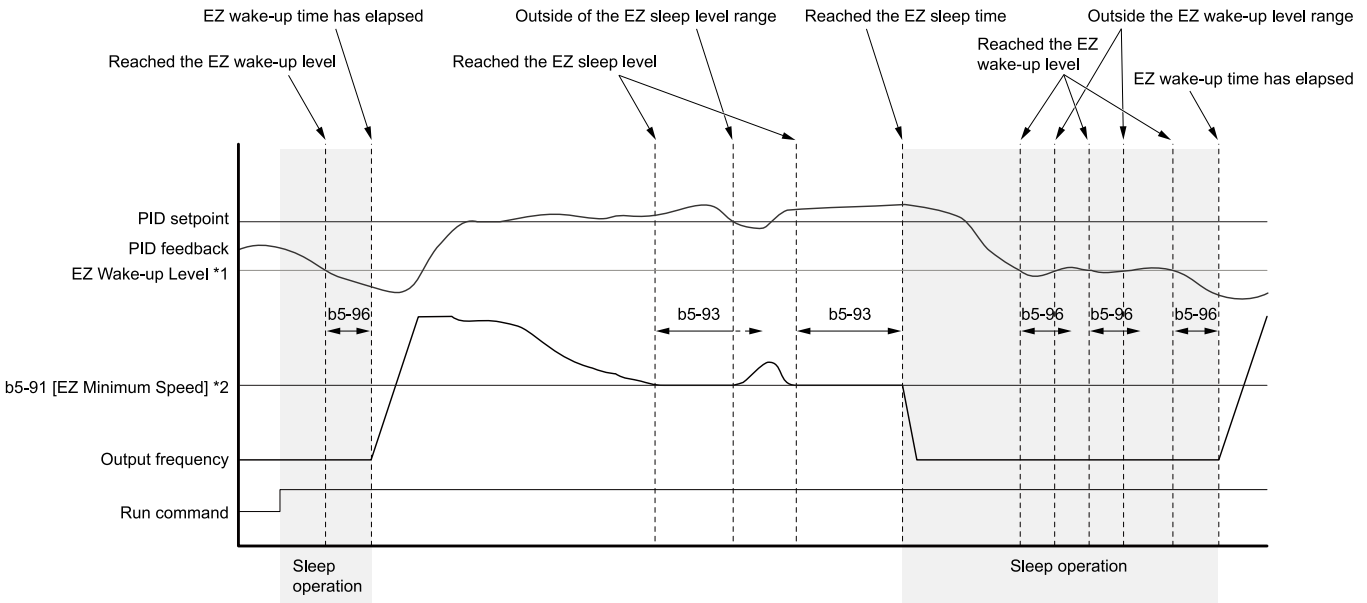

Figure 12.39 EZ Sleep/Wake-up Operation: PID Output is Normal and *b5-92* = 0.0 Hz

*1 The values of *b5-94* and *b5-95* set operation.

*2 In the example, *b5-92* is at the default setting of 0.0 Hz. Parameter *b5-91* is the EZ sleep level.

■ b5-01: PID Mode Setting

No. (Hex.)	Name	Description	Default (Range)
b5-01 (01A5)	PID Mode Setting	<input type="checkbox"/> V/f <input type="checkbox"/> CL-V/f <input type="checkbox"/> OLV <input type="checkbox"/> CLV <input type="checkbox"/> AOLV <input type="checkbox"/> OLV/PM <input type="checkbox"/> AOLV/PM <input type="checkbox"/> CLV/PM <input checked="" type="checkbox"/> EZOLV	0 (0 - 8)

0 : Disabled

1 : Standard

Enables PID control. The drive does D control on the difference between the feedback value and the PID setpoint output through *U5-02* [PID Input].

2 : Standard (D on feedback)

Enables PID control. The drive does D control on the feedback output through *U5-06* [PID FdbkDif PID Fdbk].

3 : Fref + PID Trim

Enables PID control. The drive adds the frequency reference to the PID output. The drive does D control on the difference between the feedback value and the PID setpoint output through *U5-02* [PID Input].

4 : Fref + PID Trim (D on feedback)

Enables PID control. The drive adds the frequency reference to the PID output. The drive does D control on the feedback output through *U5-06* [PID FdbkDif PID Fdbk].

5 : Same as 7series & prior, b5-01=1

6 : Same as 7series & prior, b5-01=2

7 : Same as 7series & prior, b5-01=3

8 : Same as 7series & prior, b5-01=4

Note:

Use settings 5 to 8 instead of settings 1 to 4 when the drive is a replacement for Varispeed F7.

■ b5-02: Proportional Gain (P)

No. (Hex.)	Name	Description	Default (Range)
b5-02 (01A6) RUN	Proportional Gain (P)	V/f CL-V/f OLV CLV AOLV OLV/PM AOLV/PM CLV/PM EZOLV Sets the proportional gain (P) that is applied to PID input.	1.00 (0.00 - 25.00)

Larger values decrease errors, but can cause oscillations. Smaller values let too much offset between the setpoint and feedback.

Set $b5-02 = 0.00$ to disable P control.

■ b5-03: Integral Time (I)

No. (Hex.)	Name	Description	Default (Range)
b5-03 (01A7) RUN	Integral Time (I)	V/f CL-V/f OLV CLV AOLV OLV/PM AOLV/PM CLV/PM EZOLV Sets the integral time (I) that is applied to PID input.	1.0 s (0.0 - 360.0 s)

Set a short integral time in $b5-03$ to remove the offset more quickly. If the integral time is too short, overshoot or oscillation can occur.

Set $b5-03 = 0.00$ to disable I control.

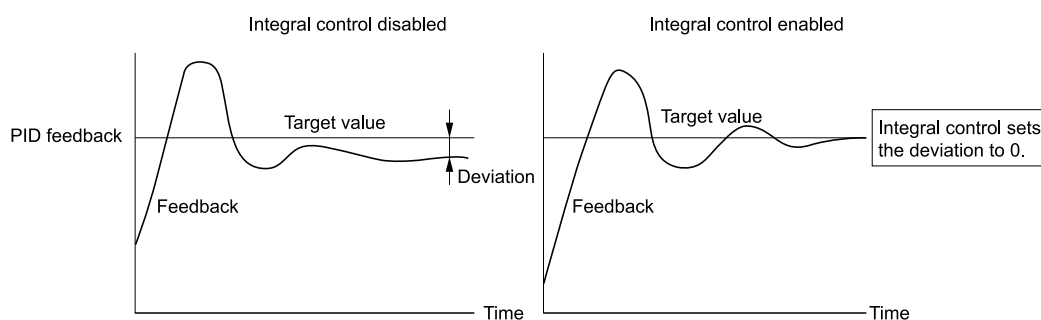

Figure 12.40 Integral Time and Deviation

■ b5-04: Integral Limit

No. (Hex.)	Name	Description	Default (Range)
b5-04 (01A8) RUN	Integral Limit	V/f CL-V/f OLV CLV AOLV OLV/PM AOLV/PM CLV/PM EZOLV Sets the upper limit for integral control (I) as a percentage of the Maximum Output Frequency.	100.0% (0.0 - 100.0%)

Applications with loads that quickly change will cause the output of the PID function to oscillate. Set this parameter to a low value to prevent oscillation, mechanical loss, and motor speed loss.

■ b5-05: Derivative Time (D)

No. (Hex.)	Name	Description	Default (Range)
b5-05 (01A9) RUN	Derivative Time (D)	V/f CL-V/f OLV CLV AOLV OLV/PM AOLV/PM CLV/PM EZOLV Sets the derivative time (D) for PID control. This parameter adjusts system responsiveness.	0.00 s (0.00 - 10.00 s)

When you increase the time setting, it will increase controller responsiveness, but it can also cause vibration. When you decrease the time setting, it will suppress overshoot and decrease controller responsiveness.

Set $b5-05 = 0.00$ to disable D control.

■ b5-06: PID Output Limit

No. (Hex.)	Name	Description	Default (Range)
b5-06 (01AA) RUN	PID Output Limit	V/f CL-V/f OLV CLV AOLV OLV/PM AOLV/PM CLV/PM EZOLV Sets the maximum possible output from the PID controller as a percentage of the Maximum Output Frequency.	100.0% (0.0 - 100.0%)

■ b5-07: PID Offset Adjustment

No. (Hex.)	Name	Description	Default (Range)
b5-07 (01AB) RUN	PID Offset Adjustment	V/f CL-V/f OLV CLV AOLV OLV/PM AOLV/PM CLV/PM EZOLV Sets the offset for the PID control output as a percentage of the Maximum Output Frequency.	0.0% (-100.0 - +100.0%)

■ b5-08: PID Primary Delay Time Constant

No. (Hex.)	Name	Description	Default (Range)
b5-08 (01AC) RUN Expert	PID Primary Delay Time Constant	V/f CL-V/f OLV CLV AOLV OLV/PM AOLV/PM CLV/PM EZOLV Sets the primary delay time constant for the PID control output. Usually it is not necessary to change this setting.	0.00 s (0.00 - 10.00 s)

Prevents resonance if there is a large quantity of mechanical friction or if rigidity is unsatisfactory. Set the value larger than the resonant frequency cycle. A value that is too large will decrease drive responsiveness.

■ b5-09: PID Output Level Selection

No. (Hex.)	Name	Description	Default (Range)
b5-09 (01AD)	PID Output Level Selection	V/f CL-V/f OLV CLV AOLV OLV/PM AOLV/PM CLV/PM EZOLV Sets the polarity of the PID output.	0 (0, 1)

Use this parameter in applications that decrease the drive output frequency when you increase the PID setpoint.

0 : Normal Output (Direct Acting)

A positive PID input increases the PID output (direct acting).

1 : Reverse Output (Reverse Acting)

A positive PID input decreases the PID output (reverse acting).

■ b5-10: PID Output Gain Setting

No. (Hex.)	Name	Description	Default (Range)
b5-10 (01AE) RUN	PID Output Gain Setting	V/f CL-V/f OLV CLV AOLV OLV/PM AOLV/PM CLV/PM EZOLV Sets the amount of gain to apply to the PID output.	1.00 (0.00 - 25.00)

Applies a gain to the PID output and can help when $b5-01 = 3$ or 4 [PID Mode Setting = $Fref + PID Trim$, $Fref + PID Trim (D on feedback)$].

■ b5-11: PID Output Reverse Selection

No. (Hex.)	Name	Description	Default (Range)
b5-11 (01AF)	PID Output Reverse Selection	V/f CL-V/f OLV CLV AOLV OLV/PM AOLV/PM CLV/PM EZOLV Sets the function that enables and disables reverse motor rotation for negative PID control output.	0 (0, 1)

This parameter is disabled when $b5-01 = 3, 4$ [PID Mode Setting = $Fref + PID Trim$, $Fref + PID Trim (D on feedback)$]. There is no limit for PID output (PID output can be positive or negative). Operates the same as setting "1: Enabled: Negative lower limit".

0 : Lower Limit is Zero

When PID output is negative, PID output is limited to 0 and drive output is shut off.

1 : Negative Output Accepted

When the PID output is negative, the motor will rotate in reverse. When $b1-04 = 1$ [Reverse Operation Selection = Reverse Disabled], the lower limit is 0.

■ b5-12: Feedback Loss Detection Select

No. (Hex.)	Name	Description	Default (Range)
b5-12 (01B0)	Feedback Loss Detection Select	<div style="display: flex; gap: 5px;"> V/f CL-V/f OLV CLV AOLV OLV/PM AOLV/PM CLV/PM EZOLV </div> Sets the drive response to PID Feedback Low/High. Sets drive operation after the drive detects PID feedback Low/High.	0 (0 - 5)

0 : Digital Out Only, Always Detect

The MFDO terminal set for *PID Feedback Low* or *PID Feedback High* [H2-01 to H2-03 = 3E, 3F] activates. When the drive detects Feedback Low/High, the keypad will not show a minor fault/alarm and the drive will continue operation.

When the feedback signal is less than the level set in *b5-13* [*PID Feedback Loss Detection Lvl*] for longer than the time set in *b5-14* [*PID Feedback Loss Detection Time*], the MFDO terminal set for a *PID Feedback Low* activates.

When the feedback signal is more than the level set in *b5-36* [*PID High Feedback Detection Lvl*] for longer than the time set in *b5-37* [*PID High Feedback Detection Time*] the MFDO terminal set for a *PID Feedback High* activates.

When the feedback value is not in the detection range, the drive resets the MFDO.

1 : Alarm + Digital Out, Always Det

The drive detects *FbL* [*PID Feedback Loss*] and *FbH* [*Excessive PID Feedback*]. The MFDO terminal set for *PID Feedback Low* or *PID Feedback High* [H2-01 to H2-03 = 3E, 3F] activates. The output terminal set for *Alarm* [H2-01 to H2-03 = 10] activates and the drive continues operation.

When the feedback signal is less than the level set in *b5-13* for longer than the time set in *b5-14*, the MFDO terminal set for a *PID Feedback Low* activates.

When the feedback signal is less than the level set in *b5-36* for longer than the time set in *b5-37*, the MFDO terminal set for a *PID Feedback High* activates.

When the feedback value is not in the detection range, the drive resets the MFDO.

2 : Fault + Digital Out, Always Det

The drive detects *FbL* and *FbH*. Fault relay output terminal MA-MC activates, MB-MC turns OFF, and the motor coasts to stop.

When the feedback signal is less than the level set in *b5-13* for the time set in *b5-14*, the drive detects *FbL*.

When the feedback signal is less than the level set in *b5-36* for the time set in *b5-37*, the drive detects *FbH*.

3 : Digital Out Only, @PID Enable

The MFDO terminal set for *PID Feedback Low* or *PID Feedback High* activates. The keypad will not show a minor fault/alarm. The drive continues operation.

When the MFDI terminal set to *PID Disable* [H1-xx = 19] activates, the drive disables fault detection.

4 : Alarm + Digital Out, @PID Enable

The drive detects *FbL* and *FbH*. The MFDO terminal set for *PID Feedback Low* or *PID Feedback High* activates. The output terminal set for *Alarm* [H2-01 to H2-03 = 10] activates and the drive continues operation.

When the MFDI terminal set to *PID Disable* [H1-xx = 19] activates, the drive disables fault detection.

5 : Fault + Digital Out, @PID Enable

The drive detects *FbL* and *FbH*. Fault relay output terminal MA-MC activates, MB-MC turns OFF, and the drive coasts to stop.

When the MFDI terminal set to *PID Disable* [H1-xx = 19] activates, the drive disables fault detection.

■ b5-13: PID Feedback Loss Detection Lvl

No. (Hex.)	Name	Description	Default (Range)
b5-13 (01B1)	PID Feedback Loss Detection Lvl	<div style="display: flex; gap: 5px;"> V/f CL-V/f OLV CLV AOLV OLV/PM AOLV/PM CLV/PM EZOLV </div> Sets the level that triggers <i>PID Feedback Loss</i> [<i>FbL</i>] detection as a percentage of the Maximum Output Frequency.	0% (0 - 100%)

The drive detects *PID Feedback Loss* [*FbL*] when the feedback signal decreases to less than the level set in *b5-13* for longer than the time set in *b5-14* [*PID Feedback Loss Detection Time*].

■ b5-14: PID Feedback Loss Detection Time

No. (Hex.)	Name	Description	Default (Range)
b5-14 (01B2)	PID Feedback Loss Detection Time	<div style="display: flex; justify-content: space-between; align-items: center;"> V/f CL-V/f OLV CLV AOLV OLV/PM AOLV/PM CLV/PM EZOLV </div> Sets the length of time that PID Feedback must be less than <i>b5-13</i> [PID Feedback Loss Detection Lvl] to detect PID Feedback Loss [FbL].	1.0 s (0.0 - 25.5 s)

■ b5-15: PID Sleep Function Start Level

No. (Hex.)	Name	Description	Default (Range)
b5-15 (01B3)	PID Sleep Function Start Level	<div style="display: flex; justify-content: space-between; align-items: center;"> V/f CL-V/f OLV CLV AOLV OLV/PM AOLV/PM CLV/PM EZOLV </div> Sets the output level that triggers the PID Sleep function.	Determined by A1-02 (0.0 - 590.0)

The drive goes into Sleep mode when the PID output or frequency reference is less than *b5-15* for longer than the time set to *b5-16* [PID Sleep Delay Time]. The drive continues operation when the PID output or frequency reference is more than *b5-15* for longer than the time set to *b5-16*.

■ b5-16: PID Sleep Delay Time

No. (Hex.)	Name	Description	Default (Range)
b5-16 (01B4)	PID Sleep Delay Time	<div style="display: flex; justify-content: space-between; align-items: center;"> V/f CL-V/f OLV CLV AOLV OLV/PM AOLV/PM CLV/PM EZOLV </div> Sets a delay time to start or stop the PID Sleep function.	0.0 s (0.0 - 25.5 s)

■ b5-17: PID Accel/Decel Time

No. (Hex.)	Name	Description	Default (Range)
b5-17 (01B5) RUN	PID Accel/Decel Time	<div style="display: flex; justify-content: space-between; align-items: center;"> V/f CL-V/f OLV CLV AOLV OLV/PM AOLV/PM CLV/PM EZOLV </div> Raises or lowers the PID setpoint using the acceleration and deceleration times set to the drive. This is a soft-starter for the PID setpoint.	0.0 s (0.0 - 6000.0 s)

The drive usually uses the acceleration and deceleration times set in *C1-xx* [Accel and Decel Times], but when PID control is enabled, the drive applies *C1-xx* after PID output. If you frequently change the PID setpoint, the drive responsiveness decreases. When resonance with PID control causes hunting, overshoot, or undershoot, set *b5-17* for longer acceleration and deceleration times.

Decrease *C1-xx* until hunting stops, then use *b5-17* to check the acceleration and deceleration. To enable and disable the setting in *b5-17* through an MFDI terminal, set *PID Soft Starter Disable* [H1-xx = 34].

■ b5-18: b5-19 PID Setpoint Selection

No. (Hex.)	Name	Description	Default (Range)
b5-18 (01DC)	b5-19 PID Setpoint Selection	<div style="display: flex; justify-content: space-between; align-items: center;"> V/f CL-V/f OLV CLV AOLV OLV/PM AOLV/PM CLV/PM EZOLV </div> Sets the function that enables and disables <i>b5-19</i> [PID Setpoint Value].	0 (0, 1)

0 : Disabled

The drive does not use the value set in *b5-19* as the PID setpoint.

1 : Enabled

The drive uses the value set in *b5-19* as the PID setpoint.

■ b5-19: PID Setpoint Value

No. (Hex.)	Name	Description	Default (Range)
b5-19 (01DD) RUN	PID Setpoint Value	<div style="display: flex; justify-content: space-between; align-items: center;"> V/f CL-V/f OLV CLV AOLV OLV/PM AOLV/PM CLV/PM EZOLV </div> Sets the PID setpoint when <i>b5-18</i> = 1 [b5-19 PID Setpoint Selection = Enabled].	0.00% (0.00 - 100.00%)

■ b5-20: PID Unit Selection

No. (Hex.)	Name	Description	Default (Range)
b5-20 (01E2)	PID Unit Selection	<div style="display: flex; justify-content: space-between; align-items: center;"> V/f CL-V/f OLV CLV AOLV OLV/PM AOLV/PM CLV/PM EZOLV </div> Sets the number of digits to set and show the PID setpoint.	1 (0 - 3)

Set the units for these parameters and monitors:

- b5-19 [PID Setpoint Value]
- b5-58 [PID Setpoint2]
- b5-59 [PID Setpoint3]
- b5-60 [PID Setpoint4]
- U5-01 [PID Feedback]
- U5-04 [PID Setpoint]
- U5-99 [PID Setpoint Command]

0 : 0.01Hz units

The drive uses 0.01 Hz units.

1 : 0.01% units

The drive uses 0.01% units. Set the value as a percentage of *E1-04 [Maximum Output Frequency]*.

2 : min⁻¹

The drive uses 1 min⁻¹ unit. Set *E2-04, E4-04, or E5-04 [Motor Pole Count]*.

3 : User Units

The drive uses the units set in *b5-38 [PID User Unit Display Scaling]* and *b5-39 [PID User Unit Display Digits]* to show the PID setpoint in *U5-01, U5-04, U5-06 [PID Feedback, PID Setpoint, PID Fdbk-Diff PID Fdbk]*.

■ b5-34: PID Output Lower Limit Level

No. (Hex.)	Name	Description	Default (Range)
b5-34 (019F) RUN	PID Output Lower Limit Level	<div style="display: flex; justify-content: space-between; align-items: center;"> V/f CL-V/f OLV CLV AOLV OLV/PM AOLV/PM CLV/PM EZOLV </div> Sets the lower limit level for the PID control as a percentage of <i>E1-04 [Maximum Output Frequency]</i> .	0.0% (-100.0 - +100.0%)

Use a lower limit to keep PID control output from dropping below a fixed level.

When you use *b5-34*, set *b5-91 = 0 [EZ Sleep Minimum Speed = 0 (Disabled)]*.

When you set the output lower limit level in Hz or min⁻¹ (r/min), refer to [b5-91: EZ Sleep Minimum Speed on page 721](#).

Set this parameter to 0.0% to disable this function.

■ b5-35: PID Input Limit Level

No. (Hex.)	Name	Description	Default (Range)
b5-35 (01A0) RUN	PID Input Limit Level	<div style="display: flex; justify-content: space-between; align-items: center;"> V/f CL-V/f OLV CLV AOLV OLV/PM AOLV/PM CLV/PM EZOLV </div> Sets the output upper limit for the PID control as a percentage of the Maximum Output Frequency.	1000.0% (0.0 - 1000.0%)

A large input value for PID control makes a high output. The drive applies this limit to the negative and positive domains.

■ b5-36: PID High Feedback Detection Lvl

No. (Hex.)	Name	Description	Default (Range)
b5-36 (01A1)	PID High Feedback Detection Lvl	<div style="display: flex; justify-content: space-between; align-items: center;"> V/f CL-V/f OLV CLV AOLV OLV/PM AOLV/PM CLV/PM EZOLV </div> Sets the level that triggers <i>Excessive PID Feedback [FbH]</i> as a percentage of the Maximum Output Frequency.	100% (0 - 100%)

When the feedback signal increases to more than the level set in *b5-36* for the time set in *b5-37 [PID High Feedback Detection Time]*, the drive will detect *Excessive PID Feedback [FbH]*.

■ b5-37: PID High Feedback Detection Time

No. (Hex.)	Name	Description	Default (Range)
b5-37 (01A2)	PID High Feedback Detection Time	<div style="display: flex; justify-content: space-between; font-size: small;"> V/f CL-V/f OLV CLV AOLV OLV/PM AOLV/PM CLV/PM EZOLV </div> Sets the length of time that the PID feedback signal must be more than the level set in b5-36 [PID Feedback High Detection Lvl] to cause Excessive PID Feedback [FbH].	1.0 s (0.0 - 25.5 s)

■ b5-38: PID User Unit Display Scaling

No. (Hex.)	Name	Description	Default (Range)
b5-38 (01FE)	PID User Unit Display Scaling	<div style="display: flex; justify-content: space-between; font-size: small;"> V/f CL-V/f OLV CLV AOLV OLV/PM AOLV/PM CLV/PM EZOLV </div> Sets the value that the drive sets or shows as the PID setpoint when at the maximum output frequency.	Determined by b5-20 (1 - 60000)

The drive uses this parameter and b5-39 [PID Setpoint Display Digits] together.

When b5-20 = 3 [PID Unit Selection = User Units], the drive applies user-set PID setpoint and display units to these parameters and monitors:

- b5-19 [PID Setpoint Value]
- b5-58 [PID Setpoint2]
- b5-59 [PID Setpoint3]
- b5-60 [PID Setpoint4]
- U5-01 [PID Feedback]
- U5-04 [PID Setpoint]
- U5-99 [PID Setpoint Command]

■ b5-39: PID User Unit Display Digits

No. (Hex.)	Name	Description	Default (Range)
b5-39 (01FF)	PID User Unit Display Digits	<div style="display: flex; justify-content: space-between; font-size: small;"> V/f CL-V/f OLV CLV AOLV OLV/PM AOLV/PM CLV/PM EZOLV </div> Sets the number of digits to set and show the PID setpoint.	Determined by b5-20 (0 - 3)

The drive uses this parameter and b5-38 [PID Setpoint User Display] together.

When b5-20 = 3 [PID Unit Selection = User Units], the drive applies user-set PID setpoint and display units to these parameters and monitors:

- b5-19 [PID Setpoint Value]
- b5-58 [PID Setpoint2]
- b5-59 [PID Setpoint3]
- b5-60 [PID Setpoint4]
- U5-01 [PID Feedback]
- U5-04 [PID Setpoint]
- U5-99 [PID Setpoint Command]

0 : No Decimal Places (XXXXX)

1 : One Decimal Places (XXXX.X)

2 : Two Decimal Places (XXX.XX)

3 : Three Decimal Places (XX.XXX)

■ b5-40: Frequency Reference Monitor @PID

No. (Hex.)	Name	Description	Default (Range)
b5-40 (017F)	Frequency Reference Monitor @PID	<div style="display: flex; justify-content: space-between; font-size: small;"> V/f CL-V/f OLV CLV AOLV OLV/PM AOLV/PM CLV/PM EZOLV </div> Sets the contents for monitor U1-01 [Frequency Reference] in PID control.	0 (0, 1)

0 : U1-01 Includes PID Output

Monitor U1-01 shows the frequency reference that was increased or decreased by the PID output.

1 : U1-01 Excludes PID Output

Monitor U1-01 shows the actual frequency reference.

■ b5-47: PID Trim Mode Output Reverse Sel

No. (Hex.)	Name	Description	Default (Range)
b5-47 (017D)	PID Trim Mode Output Reverse Sel	V/f CL-V/f OLV CLV AOLV OLV/PM AOLV/PM CLV/PM EZOLV Sets reverse motor rotation when the PID control output is negative.	1 (0, 1)

This parameter is enabled when $b5-01 = 3$ or 4 [PID Mode Setting = Fref + PID Trim, Fref + PID Trim (D on feedback)].

0 : Lower Limit is Zero

When PID output is negative, PID output is limited to 0 and drive output is shut off.

1 : Negative Output Accepted

When the PID output is negative, the motor will rotate in reverse.

■ b5-53: PID Integrator Ramp Limit

No. (Hex.)	Name	Description	Default (Range)
b5-53 (0B8F) RUN	PID Integrator Ramp Limit	V/f CL-V/f OLV CLV AOLV OLV/PM AOLV/PM CLV/PM EZOLV Sets the responsiveness of PID control when the PID feedback changes quickly.	0.0 Hz (0.0 - 10.0 Hz)

Note:

- This parameter is disabled when set to 0.0 Hz.
- When $b5-53 > 0.0$ Hz and the drive enables the integrator ramp limit, the PID integrator value limit is the range set by the output frequency $\pm b5-53$.
- When the PID feedback changes quickly, gradually decrease the value of this parameter in increments of 0.1 Hz to decrease the speed of the response of PID control.

■ b5-55: PID Feedback Monitor Selection

No. (Hex.)	Name	Description	Default (Range)
b5-55 (0BE1)	PID Feedback Monitor Selection	V/f CL-V/f OLV CLV AOLV OLV/PM AOLV/PM CLV/PM EZOLV Sets the monitor ($Ux-xx$) used as the PID Feedback.	000 (000 - 9999)

Note:

- Set the $x-xx$ part of the $Ux-xx$ [Monitor]. For example, set $b5-55 = 102$ to monitor $U1-02$ [Output Frequency]. When the x part of Ux is a letter, replace the letter (hexadecimal number) with a decimal number. For example, set $b5-55 = 1301$ to monitor $Ud-01$.
- You cannot select parameter $U5-xx$.
- This parameter is disabled when you set it to 000.

■ b5-56: PID Feedback Monitor Gain

No. (Hex.)	Name	Description	Default (Range)
b5-56 (0BE2)	PID Feedback Monitor Gain	V/f CL-V/f OLV CLV AOLV OLV/PM AOLV/PM CLV/PM EZOLV Sets the gain for the monitor set in $b5-55$ [PID Feedback Monitor Selection].	1.00 (0.00 - 10.00)

■ b5-57: PID Feedback Monitor Bias

No. (Hex.)	Name	Description	Default (Range)
b5-57 (11DD)	PID Feedback Monitor Bias	V/f CL-V/f OLV CLV AOLV OLV/PM AOLV/PM CLV/PM EZOLV Sets the bias for the monitor specified in $b5-55$ [PID Feedback Monitor Selection].	0.00 (-10.00 - +10.00)

■ b5-58 to b5-60: PID Setpoints 2 to 4

No. (Hex.)	Name	Description	Default (Range)
b5-58 to b5-60: (1182 - 1184) RUN	PID Setpoints 2 to 4	V/f CL-V/f OLV CLV AOLV OLV/PM AOLV/PM CLV/PM EZOLV Sets the PID setpoint when $H1-xx = 3E$ or $3F$ [MFDI Function Selection = PID Setpoint Selection 1/2]. This value is a percentage of the maximum output frequency.	0.00% (0.00 - 100.00%)

Table 12.32 shows how the different MFDI $H1-xx$ values ($3E$ and $3F$) have an effect on the PID setpoint value.

Table 12.32 Switching of MFDI and PID Setpoint Value

H1-xx = 3E	H1-xx = 3F	PID Setpoint Value
OFF	OFF	No switch
ON	OFF	b5-58 [PID Setpoint2]
OFF	ON	b5-59 [PID Setpoint3]
ON	ON	b5-60 [PID Setpoint4]

■ **b5-61: PID Trim Mode Lower Limit Sel**

No. (Hex.)	Name	Description	Default (Range)
b5-61 (119A)	PID Trim Mode Lower Limit Sel	V/f CL-V/f OLV CLV AOLV OLV/PM AOLV/PM CLV/PM EZOLV Sets the function that adjusts the PID output in relation to the frequency reference.	0 (0, 1)

0 : Disabled

Does not adjust the PID output with the frequency reference.

1 : Enabled

Adjusts the PID output in relation to the frequency reference. The setting value of *b5-62 [PID Trim Mode Lower Limit Value]* sets the lower limit of the post-adjustment value. The maximum output frequency sets the upper limit.

Note:

- Set *b5-01 = 3, 4, 7, or 8* to enable this parameter.
- When *b5-61 = 1*, you can use this formula to adjust PID output proportional to the frequency reference:

$$U5-03 = U5-03 \times \left| \frac{Fref}{Fmax} \right|^{*1}$$

U5-03 [PID Output], *Fref* [Frequency Reference], and *Fmax* [Maximum Output Frequency]

*1 Lower limit = *b5-62*, Upper limit = Maximum output frequency

■ **b5-62: PID Trim Mode Lower Limit Value**

No. (Hex.)	Name	Description	Default (Range)
b5-62 (119B)	PID Trim Mode Lower Limit Value	V/f CL-V/f OLV CLV AOLV OLV/PM AOLV/PM CLV/PM EZOLV Sets the PID Trim Mode Lower Limit Value as a percentage of the maximum output frequency.	0.00% (0.00 - 100.00%)

Note:

Set *b5-01 = 3, 4, 7, or 8* to enable this parameter.

■ **b5-63: PID Differential FB Monitor Sel**

No. (Hex.)	Name	Description	Default (Range)
b5-63 (119C)	PID Differential FB Monitor Sel	V/f CL-V/f OLV CLV AOLV OLV/PM AOLV/PM CLV/PM EZOLV Selects the monitor (<i>Ux-xx</i>) used as the PID Differential Feedback.	000 (000 - 9999)

Note:

- Set the *x-xx* part of the *Ux-xx* [Monitor]. For example, set *b5-63 = 103* to monitor *U1-03* [Output Current]. When the *x* part of *Ux* is a letter, replace the letter (hexadecimal number) with a decimal number. For example, set *b5-63 = 1301* to monitor *Ud-01*.
- You cannot select parameter *U5-xx*.
- This parameter is disabled when you set it to *000*.

■ **b5-64: PID Differential FB Monitor Gain**

No. (Hex.)	Name	Description	Default (Range)
b5-64 (119D)	PID Differential FB Monitor Gain	V/f CL-V/f OLV CLV AOLV OLV/PM AOLV/PM CLV/PM EZOLV Sets the gain for the monitor specified in <i>b5-63</i> [PID Differential FB Monitor Sel].	1.00 (0.00 - 10.00)

■ b5-65: PID Differential FB Monitor Bias

No. (Hex.)	Name	Description	Default (Range)
b5-65 (119F)	PID Differential FB Monitor Bias	V/f CL-V/f OLV CLV AOLV OLV/PM AOLV/PM CLV/PM EZOLV Sets the bias for the monitor specified in b5-63 [PID Differential FB Monitor Sel].	0.00 (-10.00 - +10.00)

■ b5-66: PID Feedback Monitor Level

No. (Hex.)	Name	Description	Default (Range)
b5-66 (11DE)	PID Feedback Monitor Level	V/f CL-V/f OLV CLV AOLV OLV/PM AOLV/PM CLV/PM EZOLV Sets the signal level for the monitor specified in b5-55 [PID Feedback Monitor Selection].	0 (0, 1)

0 : Absolute

1 : Bi-directional (+/-)

■ b5-67: PID Differential FB Monitor Lvl

No. (Hex.)	Name	Description	Default (Range)
b5-67 (11DF)	PID Differential FB Monitor Lvl	V/f CL-V/f OLV CLV AOLV OLV/PM AOLV/PM CLV/PM EZOLV Sets the signal level for the monitor specified in b5-63 [PID Differential FB Monitor Sel].	0 (0, 1)

0 : Absolute

1 : Bi-directional (+/-)

■ b5-89: Sleep Method Selection

No. (Hex.)	Name	Description	Default (Range)
b5-89 (0B89) RUN	Sleep Method Selection	V/f CL-V/f OLV CLV AOLV OLV/PM AOLV/PM CLV/PM EZOLV Sets sleep and wake up operation when using PID.	0 (0, 1)

0 : Standard

1 : EZ Sleep/Wake-up

■ b5-90: EZ Sleep Unit

No. (Hex.)	Name	Description	Default (Range)
b5-90 (0B90) RUN	EZ Sleep Unit	V/f CL-V/f OLV CLV AOLV OLV/PM AOLV/PM CLV/PM EZOLV Sets the measurement units for b5-91 [EZ Sleep Minimum Speed] and b5-92 [EZ Sleep Level].	0 (0, 1)

0 : 0.1Hz units

1 : rev/min

■ b5-91: EZ Sleep Minimum Speed

No. (Hex.)	Name	Description	Default (Range)
b5-91 (0B91) RUN	EZ Sleep Minimum Speed	V/f CL-V/f OLV CLV AOLV OLV/PM AOLV/PM CLV/PM EZOLV Sets the output lower limit level for the PID control as Hz units or min ⁻¹ (r/min) units.	0.0 Hz or 0 min ⁻¹ (r/min) (0.0 to 590.0 Hz or 0 to 35400 min ⁻¹ (r/min))

When you use b5-91, set b5-34 = 0.0 [PID Output Lower Limit Level = 0.0 (disabled)].

When you set the lower limit for PID output as a percentage of the Maximum Output Frequency, refer to page b5-34: PID Output Lower Limit Level on page 717.

Note:

The value of b5-90 [EZ Sleep Unit] sets the units. When b5-90 changes, this parameter does not automatically update. Set this parameter again after you change b5-90.

■ **b5-92: EZ Sleep Level**

No. (Hex.)	Name	Description	Default (Range)
b5-92 (0B92) RUN	EZ Sleep Level	V/f CL-V/f OLV CLV AOLV OLV/PM AOLV/PM CLV/PM EZOLV Sets the value that the output frequency or motor speed must be less than for longer than <i>b5-93</i> [<i>EZ Sleep Time</i>] to enter Sleep Mode.	0.0 Hz or 0 min ⁻¹ (r/min) (0.0 to 590.0 Hz or 0 to 35400 min ⁻¹ (r/min))

Note:

When *b5-90* [*EZ Sleep Unit*] changes, this parameter does not automatically update. Set this parameter again after you change *b5-90*.

■ **b5-93: EZ Sleep Time**

No. (Hex.)	Name	Description	Default (Range)
b5-93 (0B93) RUN	EZ Sleep Time	V/f CL-V/f OLV CLV AOLV OLV/PM AOLV/PM CLV/PM EZOLV Sets the length of time that the output frequency or motor speed must be less than <i>b5-92</i> [<i>EZ Sleep Level</i>] to enter Sleep Mode.	5.0 s (0.0 - 1000.0 s)

■ **b5-94: EZ Sleep Wake-up Level**

No. (Hex.)	Name	Description	Default (Range)
b5-94 (0B94) RUN	EZ Sleep Wake-up Level	V/f CL-V/f OLV CLV AOLV OLV/PM AOLV/PM CLV/PM EZOLV Sets the level at which the drive resumes operation when exiting Sleep Mode.	0.00% (0.00 - 600.00%)

Note:

The values of *b5-20* [*PID Unit Selection*], *b5-38* [*PID User Unit Display Scaling*], and *b5-39* [*PID User Unit Display Digits*] set the units. When *b5-20*, *b5-38*, and *b5-39* change, this parameter does not automatically update. Set this parameter again after you change *b5-20*, *b5-38*, and *b5-39* are changed.

- When *b5-95* = 0 [*EZ Sleep Wake-up Mode = Absolute*]:
When *b5-09* = 0 [*PID Output Level Selection = Normal Output (Direct Acting)*], and the PID Feedback [*H3-xx* = *B*] is less than the value of *b5-94* for a time longer than the value of *b5-96* [*EZ Sleep Wake-up Time*], the drive will exit sleep and start operation again. When *b5-09* = 1 [*Reverse Output (Reverse Acting)*], and the PID feedback is more than setting value of *b5-94* for a time longer than the setting value of *b5-96*, the drive will exit sleep and start operation again.
- When *b5-95* = 1 [*Setpoint Delta*]:
When *b5-09* = 0, and the PID feedback is less than the value of “PID setpoint value - *b5-94*” for a time longer than the value of *b5-96*, the drive will exit sleep and start operation again. When *b5-09* = 1, and the PID feedback is more than the value of “PID setpoint value + *b5-94*” for a time longer than the setting value of *b5-96*, the drive will exit sleep and start operation again.

■ **b5-95: EZ Sleep Wake-up Mode**

No. (Hex.)	Name	Description	Default (Range)
b5-95 (0B95)	EZ Sleep Wake-up Mode	V/f CL-V/f OLV CLV AOLV OLV/PM AOLV/PM CLV/PM EZOLV Sets the wake-up mode to use when exiting Sleep Mode.	0 (0, 1)

0 : Absolute

1 : Setpoint Delta

■ **b5-96: EZ Sleep Wake-up Time**

No. (Hex.)	Name	Description	Default (Range)
b5-96 (0B96) RUN	EZ Sleep Wake-up Time	V/f CL-V/f OLV CLV AOLV OLV/PM AOLV/PM CLV/PM EZOLV Sets the EZ Wake-up time.	1.0 s (0.0 - 1000.0 s)

When the PID feedback is less than the value of *b5-94* [*EZ Sleep Wake-up Level*] continuously for the time set in *b5-96*, the drive will exit sleep and start operation again.

◆ **b6: Dwell Function**

The Dwell function momentarily holds the output frequency at start and stop.

This prevents motor speed loss when you start and stop heavy loads. The Dwell function is also enabled when backlash on the machine side causes sudden movement at the start of acceleration and deceleration.

At the start of acceleration, the drive uses the output frequency and acceleration time set for the Dwell function to automatically operate at low speed to minimize the effects of backlash. Then, the drive can accelerate again. The Dwell function operates the same for deceleration.

For conveyor applications, the Dwell function also lets the drive interlock the output frequency and a delay time for the holding brake on the load side.

The Dwell function momentarily stops during acceleration to prevent a PM motor from stepping out. [Figure 12.41](#) shows how the Dwell function works.

Note:

When you use the Dwell function at stop, set $b1-03 = 0$ [Stopping Method Selection = Ramp to Stop].

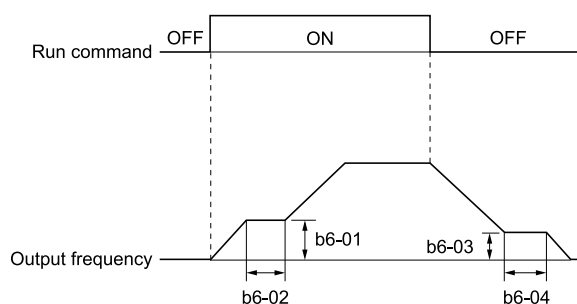

Figure 12.41 Time Chart for the Dwell Function at Start/Stop

■ b6-01: Dwell Reference at Start

No. (Hex.)	Name	Description	Default (Range)
b6-01 (01B6)	Dwell Reference at Start	V/f CL-V/f OLV CLV AOLV OLV/PM AOLV/PM CLV/PM EZOLV Sets the output frequency that the drive will hold momentarily when the motor starts.	0.0 (Determined by A1-02)

When the drive accelerates to the output frequency set in $b6-01$, it holds that frequency for the time set in $b6-02$ [Dwell Time at Start], and starts to accelerate again.

■ b6-02: Dwell Time at Start

No. (Hex.)	Name	Description	Default (Range)
b6-02 (01B7)	Dwell Time at Start	V/f CL-V/f OLV CLV AOLV OLV/PM AOLV/PM CLV/PM EZOLV Sets the length of time that the drive will hold the output frequency when the motor starts.	0.0 s (0.0 - 10.0 s)

■ b6-03: Dwell Reference at Stop

No. (Hex.)	Name	Description	Default (Range)
b6-03 (01B8)	Dwell Reference at Stop	V/f CL-V/f OLV CLV AOLV OLV/PM AOLV/PM CLV/PM EZOLV Sets the output frequency that the drive will hold momentarily when ramping to stop the motor.	0.0 (Determined by A1-02)

When the drive decelerates to the output frequency set in $b6-03$, it holds that frequency for the time set in $b6-04$ [Dwell Time at Stop] and starts to decelerate again.

■ b6-04: Dwell Time at Stop

No. (Hex.)	Name	Description	Default (Range)
b6-04 (01B9)	Dwell Time at Stop	V/f CL-V/f OLV CLV AOLV OLV/PM AOLV/PM CLV/PM EZOLV Sets the length of time for the drive to hold the output frequency when ramping to stop the motor.	0.0 s (0.0 - 10.0 s)

◆ b7: Droop Control

Droop control automatically balances the load level between two motors that operate the same load.

Droop control decreases motor speed as the load changes. You must enable the Droop control function for each motor it is operating.

12.3 b: Application

To decrease motor speed, the Droop control function decreases the speed reference when an increase in the load increases the torque reference. To increase motor speed, the Droop control function increases the speed reference when a decrease in the load decreases the torque reference. The Droop control function adjusts motor speed as the torque reference changes to balance the load between the motors.

Note:

When you use Droop control, set $n5-01 = 0$ [Feed Forward Control Selection = Disabled].

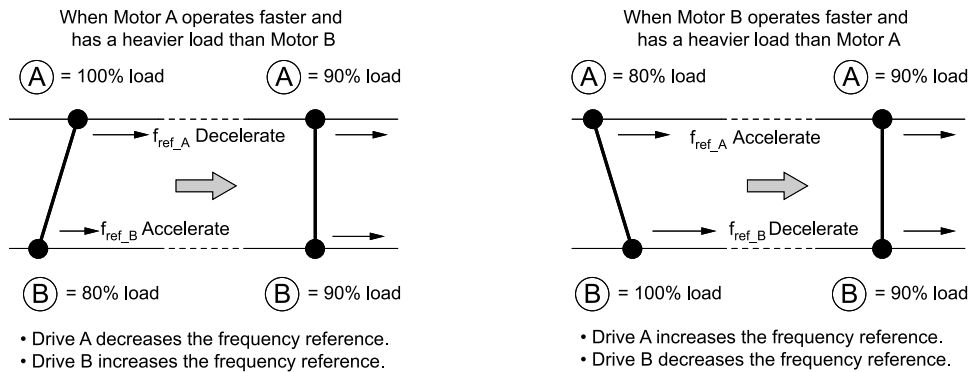

Figure 12.42 Droop Control Application (Crane Movement Viewed from Top)

■ b7-01: Droop Control Gain

No. (Hex.)	Name	Description	Default (Range)
b7-01 (01CA) RUN	Droop Control Gain	<input type="checkbox"/> V/f <input type="checkbox"/> CL-V/f <input type="checkbox"/> OLV <input checked="" type="checkbox"/> CLV <input type="checkbox"/> AOLV <input type="checkbox"/> OLV/PM <input type="checkbox"/> AOLV/PM <input type="checkbox"/> CLV/PM <input type="checkbox"/> EZOLV Sets the amount of deceleration when the torque reference is at 100% as a percentage of $E1-04$ [Maximum Output Frequency].	0.0% (0.0 - 100.0%)

To disable Droop control, set this parameter to 0.0%.

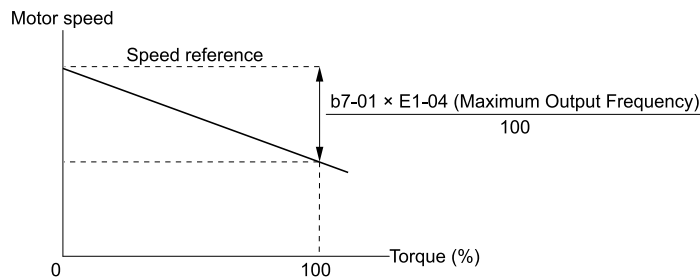

Figure 12.43 Droop Control Gain

■ b7-02: Droop Control Delay Time

No. (Hex.)	Name	Description	Default (Range)
b7-02 (01CB) RUN	Droop Control Delay Time	<input type="checkbox"/> V/f <input type="checkbox"/> CL-V/f <input type="checkbox"/> OLV <input checked="" type="checkbox"/> CLV <input type="checkbox"/> AOLV <input type="checkbox"/> OLV/PM <input type="checkbox"/> AOLV/PM <input type="checkbox"/> CLV/PM <input type="checkbox"/> EZOLV Sets the responsiveness of Droop control. Decrease this setting when drive response is slow. Increase this setting when hunting or oscillation occur.	0.05 s (0.03 - 2.00 s)

■ b7-03: Droop Control Limit Selection

No. (Hex.)	Name	Description	Default (Range)
b7-03 (017E)	Droop Control Limit Selection	<input type="checkbox"/> V/f <input type="checkbox"/> CL-V/f <input type="checkbox"/> OLV <input checked="" type="checkbox"/> CLV <input type="checkbox"/> AOLV <input type="checkbox"/> OLV/PM <input type="checkbox"/> AOLV/PM <input type="checkbox"/> CLV/PM <input type="checkbox"/> EZOLV Sets the Droop control limit function.	1 (0, 1)

0 : Disabled

1 : Enabled

◆ b8: Energy Saving

Energy-saving control improves overall system operating efficiency by operating the motor at its most efficient level.

Set *b8-01* and the following parameters according to the control mode and the motor.

- Set parameters *b8-04*, *b8-05*, and *b8-06* when using V/f Control or Closed Loop V/f Control.
- Set parameters *b8-02*, *b8-03* when using vector control with an induction motor.
- Set parameters *b8-16*, *b8-17* when using a PM motor.

Note:

- Energy-saving control is not appropriate for applications with sudden changes in the load, or applications driving heavy loads such as a traverse car application.
- Energy-saving control maximizes operation based on precise motor data set to the drive. Be sure to perform Auto-Tuning and enter the correct information about the motor before using the Energy-saving control.

■ b8-01: Energy Saving Control Selection

No. (Hex.)	Name	Description	Default (Range)
b8-01 (01CC)	Energy Saving Control Selection	<input type="checkbox"/> V/f <input type="checkbox"/> CL-V/f <input type="checkbox"/> OLV <input type="checkbox"/> CLV <input type="checkbox"/> AOLV <input type="checkbox"/> OLV/PM <input type="checkbox"/> AOLV/PM <input type="checkbox"/> CLV/PM <input type="checkbox"/> EZOLV Sets the Energy-saving control function.	0 (0 - 2)

0 : Disabled

1 : Enabled

2 : Automatic Optimization

Note:

Setting 2 is available only when *A1-02* = 6, 7 [Control Method Selection = AOLV/PM, CLV/PM] and in Expert Mode.

■ b8-02: Energy Saving Gain

No. (Hex.)	Name	Description	Default (Range)
b8-02 (01CD) RUN Expert	Energy Saving Gain	<input type="checkbox"/> V/f <input type="checkbox"/> CL-V/f <input type="checkbox"/> OLV <input type="checkbox"/> CLV <input type="checkbox"/> AOLV <input type="checkbox"/> OLV/PM <input type="checkbox"/> AOLV/PM <input type="checkbox"/> CLV/PM <input type="checkbox"/> EZOLV Sets the gain for Energy-saving control.	Determined by A1-02 (0.0 - 10.0)

Increase the setting value to increase energy saving. If the setting value is too large, the motor will stall.

■ b8-03: Energy Saving Filter Time

No. (Hex.)	Name	Description	Default (Range)
b8-03 (01CE) RUN Expert	Energy Saving Filter Time	<input type="checkbox"/> V/f <input type="checkbox"/> CL-V/f <input type="checkbox"/> OLV <input type="checkbox"/> CLV <input type="checkbox"/> AOLV <input type="checkbox"/> OLV/PM <input type="checkbox"/> AOLV/PM <input type="checkbox"/> CLV/PM <input type="checkbox"/> EZOLV Sets the responsiveness for Energy-saving control.	Determined by A1-02 , C6-01 and o2-04 (0.00 - 10.00 s)

Decrease the setting value to increase responsiveness. If the setting value is too low, operation will not be stable.

■ b8-04: Energy Saving Coefficient Value

No. (Hex.)	Name	Description	Default (Range)
b8-04 (01CF) Expert	Energy Saving Coefficient Value	<input type="checkbox"/> V/f <input type="checkbox"/> CL-V/f <input type="checkbox"/> OLV <input type="checkbox"/> CLV <input type="checkbox"/> AOLV <input type="checkbox"/> OLV/PM <input type="checkbox"/> AOLV/PM <input type="checkbox"/> CLV/PM <input type="checkbox"/> EZOLV Sets the Energy-saving control coefficient to maintain maximum motor efficiency. The default setting is for Yaskawa motors.	Determined by C6-01, E2-11, and o2-04 (0.00 - 655.00)

When you use a motor from a different manufacturer, increase the setting value in 5% increments to find the minimum value for *U1-08* [Output Power] at light loads.

When you decrease the setting value, it decreases the output voltage and decreases power consumption. If the setting value is too low, the motor will stall.

Note:

When you do Rotational Auto-Tuning, the drive will automatically set the energy-saving coefficient.

■ b8-05: Power Detection Filter Time

No. (Hex.)	Name	Description	Default (Range)
b8-05 (01D0) Expert	Power Detection Filter Time	<input type="checkbox"/> V/f <input type="checkbox"/> CL-V/f <input type="checkbox"/> OLV <input type="checkbox"/> CLV <input type="checkbox"/> AOLV <input type="checkbox"/> OLV/PM <input type="checkbox"/> AOLV/PM <input type="checkbox"/> CLV/PM <input type="checkbox"/> EZOLV Sets the time constant to measure output power.	20 ms (0 - 2000 ms)

Decrease the setting value to increase responsiveness to load changes. If you set the value too low during operation at light loads, motor speed is not stable.

■ b8-06: Search Operation Voltage Limit

No. (Hex.)	Name	Description	Default (Range)
b8-06 (01D1) Expert	Search Operation Voltage Limit	<input type="checkbox"/> V/f <input type="checkbox"/> CL-V/f <input type="checkbox"/> OLV <input type="checkbox"/> CLV <input type="checkbox"/> AOLV <input type="checkbox"/> OLV/PM <input type="checkbox"/> AOLV/PM <input type="checkbox"/> CLV/PM <input type="checkbox"/> EZOLV Sets the voltage limit for Search Operation as a percentage of the motor rated voltage.	0% (0 - 100%)

The Search Operation changes the output voltage in small increments to find a setpoint at which the drive can use minimum power to operate.

Set this parameter to 0 to disable Search Operation. This will not disable Energy-saving control.

If the setting value is too low, the motor will stall when loads suddenly increase.

■ b8-16: PM E-Save Coefficient Ki

No. (Hex.)	Name	Description	Default (Range)
b8-16 (01F8) Expert	PM E-Save Coefficient Ki	<input type="checkbox"/> V/f <input type="checkbox"/> CL-V/f <input type="checkbox"/> OLV <input type="checkbox"/> CLV <input type="checkbox"/> AOLV <input type="checkbox"/> OLV/PM <input checked="" type="checkbox"/> AOLV/PM <input type="checkbox"/> CLV/PM <input type="checkbox"/> EZOLV Sets torque linearity. This parameter uses the Ki value from the motor nameplate. Usually it is not necessary to change this setting.	1.00 (0.00 - 3.00)

When $b8-16 = 1.00$ (default), the drive will automatically calculate and control the energy-saving coefficient. If the motor nameplate has a description for "Ki", set this parameter to the Ki value.

Do this procedure to prevent oscillation when you set $b8-01 = 1$ [Energy Saving Control Selection = Enabled].

1. Check U5-21 [Energy Save Coeff Ki] and make sure that it aligns with the Ki value on the motor nameplate.
2. If the numbers are different, set $b8-16$ to the Ki value on the motor nameplate.

■ b8-17: PM E-Save Coefficient Kt

No. (Hex.)	Name	Description	Default (Range)
b8-17 (01F9) Expert	PM E-Save Coefficient Kt	<input type="checkbox"/> V/f <input type="checkbox"/> CL-V/f <input type="checkbox"/> OLV <input type="checkbox"/> CLV <input type="checkbox"/> AOLV <input type="checkbox"/> OLV/PM <input checked="" type="checkbox"/> AOLV/PM <input type="checkbox"/> CLV/PM <input type="checkbox"/> EZOLV Sets torque linearity. This parameter uses the Kt value from the motor nameplate. Usually it is not necessary to change this setting.	1.00 (0.00 - 3.00)

When $E5-01 = 1xxx, 2xxx$ [PM Motor Code Selection = Yaskawa SSR1 or SST4 series IPM motor], the drive automatically calculates the energy-saving coefficient Kt and uses that value to control operation.

Do this procedure to prevent oscillation when you set $b8-01 = 1$ [Energy Saving Control Selection = Enabled].

1. Check U5-22 [Energy Save Coeff Kt] and make sure that it aligns with the Kt value on the motor nameplate.
2. If the numbers are different, set $b8-17$ to the Kt value on the motor nameplate.

■ b8-18: E-Save d-axis Current FilterTime

No. (Hex.)	Name	Description	Default (Range)
b8-18 (01FA) Expert	E-Save d-axis Current FilterTime	<input type="checkbox"/> V/f <input type="checkbox"/> CL-V/f <input type="checkbox"/> OLV <input type="checkbox"/> CLV <input type="checkbox"/> AOLV <input type="checkbox"/> OLV/PM <input checked="" type="checkbox"/> AOLV/PM <input type="checkbox"/> CLV/PM <input type="checkbox"/> EZOLV Sets the d-axis current reference filter time constant.	0.100 s (0.000 - 5.000 s)

■ b8-19: E-Save Search Frequency

No. (Hex.)	Name	Description	Default (Range)
b8-19 (0B40) Expert	E-Save Search Frequency	V/f CL-V/f OLV CLV AOLV OLV/PM AOLV/PM CLV/PM EZOLV Sets the frequency of Energy-saving control search operations. Usually it is not necessary to change this setting.	Determined by A1-02 (10 - 300 Hz)

Note:

- If low inertia causes vibration in the machine, increase the setting value in 10 Hz increments and check the response. If $A1-02 = 8$ [Control Method Selection = EZOLV], increase the setting value in 1 Hz increments.
- To make the motor more efficient, decrease the setting value in 1 Hz increments until the point immediately before machine vibration starts to occur.

■ b8-20: E-Save Search Width

No. (Hex.)	Name	Description	Default (Range)
b8-20 (0B41) Expert	E-Save Search Width	V/f CL-V/f OLV CLV AOLV OLV/PM AOLV/PM CLV/PM EZOLV Sets the amplitude of Energy-saving control search operations.	1.0 degrees (0.1 - 5.0 degrees)

An increase in the value can make the operational efficiency better. However, if the load inertia is small, it may be necessary to adjust the value to prevent machine vibration.

Note:

- If low inertia causes vibration in the machine, decrease the setting value in 1.0-degree increments and check the response.
- To make the motor more efficient, increase the setting value in 1.0-degree increments until the point immediately before machine vibration starts to occur.

■ b8-21: PM E-Save Search Gain

No. (Hex.)	Name	Description	Default (Range)
b8-21 (0B42) Expert	PM E-Save Search Gain	V/f CL-V/f OLV CLV AOLV OLV/PM AOLV/PM CLV/PM EZOLV Sets the gain of Energy-saving control search operations.	0.3Hz (0.1 - 20.0 Hz)

When you decrease the value of $C5-01$ [ASR Proportional Gain 1], also decrease the value of $b8-21$ to keep the correct ratio.

■ b8-22: PM E-Save Search LPF Cutoff Freq

No. (Hex.)	Name	Description	Default (Range)
b8-22 (0B43) Expert	PM E-Save Search LPF Cutoff Freq	V/f CL-V/f OLV CLV AOLV OLV/PM AOLV/PM CLV/PM EZOLV Sets the frequency of the filter used to extract the high-efficiency phase from search operations. Usually it is not necessary to change this setting.	10.0 Hz (1.0 - 30.0 Hz)

■ b8-23: PM E-Save Search Limit

No. (Hex.)	Name	Description	Default (Range)
b8-23 (0B44) Expert	PM E-Save Search Limit	V/f CL-V/f OLV CLV AOLV OLV/PM AOLV/PM CLV/PM EZOLV Sets the search operations output limit. Usually it is not necessary to change this setting.	15.0 degrees (0.0 - 30.0 degrees)

When the motor characteristics are correct, increase this value to make the motor more efficient.

■ b8-24: PM E-Save High Freq ACR Gain

No. (Hex.)	Name	Description	Default (Range)
b8-24 (0B45) Expert	PM E-Save High Freq ACR Gain	V/f CL-V/f OLV CLV AOLV OLV/PM AOLV/PM CLV/PM EZOLV Sets the gain for high-frequency current control.	200.0 Hz (100.0 - 1000.0 Hz)

Note:

If the drive detects oC [Overcurrent], decrease the value.

■ **b8-25: PM E-Save Search Start Level**

No. (Hex.)	Name	Description	Default (Range)
b8-25 (0B46) Expert	PM E-Save Search Start Level	<div style="display: flex; justify-content: space-between; font-size: 0.8em;"> V/f CL-V/f OLV CLV AOLV OLV/PM AOLV/PM CLV/PM EZOLV </div> <p>Sets the start level for search operations.</p>	10.0% (0.0 - 100.0%)

Note:

If there is vibration in the machine, increase the value.

■ **b8-26: PM E-Save Power Setpoint**

No. (Hex.)	Name	Description	Default (Range)
b8-26 (0B47) Expert	PM E-Save Power Setpoint	<div style="display: flex; justify-content: space-between; font-size: 0.8em;"> V/f CL-V/f OLV CLV AOLV OLV/PM AOLV/PM CLV/PM EZOLV </div> <p>Sets a value to increase torque accuracy.</p>	0.0% (-10.0 - +10.0%)

■ **b8-28: Over Excitation Action Selection**

No. (Hex.)	Name	Description	Default (Range)
b8-28 (0B8B) Expert	Over Excitation Action Selection	<div style="display: flex; justify-content: space-between; font-size: 0.8em;"> V/f CL-V/f OLV CLV AOLV OLV/PM AOLV/PM CLV/PM EZOLV </div> <p>Sets the function for excitation operation.</p>	0 (0, 1)

When operation is not stable at low speeds, set this parameter to 1 to enable the function.

0 : Disabled

1 : Enabled

■ **b8-29: Energy Saving Priority Selection**

No. (Hex.)	Name	Description	Default (Range)
b8-29 (0B8C)	Energy Saving Priority Selection	<div style="display: flex; justify-content: space-between; font-size: 0.8em;"> V/f CL-V/f OLV CLV AOLV OLV/PM AOLV/PM CLV/PM EZOLV </div> <p>Sets the priority of drive response between changes to the load or Energy-saving control. Enable this to prioritize energy-saving control. Disable this to prioritize tracking related to fast load changes, and prevent motor stall.</p>	0 (0, 1)

Enable this parameter when there are small changes in the load. It is possible that the motor cannot respond correctly to changes in the load.

0 : Priority: Drive Response

1 : Priority: Energy Savings

■ **b8-50: Standby Mode Selection**

No. (Hex.)	Name	Description	Default (Range)
b8-50 (0B0D)	Standby Mode Selection	<div style="display: flex; justify-content: space-between; font-size: 0.8em;"> V/f CL-V/f OLV CLV AOLV OLV/PM AOLV/PM CLV/PM EZOLV </div> <p>Sets the Standby Mode function.</p>	0 (0, 1)

0 : Disabled

1 : Enabled

Standby Mode decreases how much power the drive consumes when it is in standby.

Standby Mode waits for the drive to stop, uses the relay output of an MFDO terminal to shut off the input side electromagnetic contactor (MC), then shuts off the main circuit power supply.

Note:

These conditions are also necessary for Standby Mode:

- Connect an external 24 V power supply.
- Connect an electromagnetic contactor to the drive input side and connect the MFDO terminal set for $H2-xx = 65$ [Standby Output]. When the MFDO terminal is OFF, the electromagnetic contactor must be OFF.
- Frequently starting and stopping the drive and regularly opening and closing the electromagnetic contactor will decrease the service life of the drive.

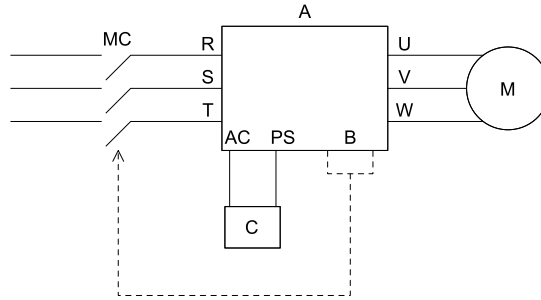

A - Drive
B - MFDO Terminal

C - External 24 V power supply

■ **b8-51: Standby Mode Wait Time**

No. (Hex.)	Name	Description	Default (Range)
b8-51 (0B01)	Standby Mode Wait Time	V/f CL-V/f OLV CLV AOLV OLV/PM AOLV/PM CLV/PM EZOLV Sets the delay time before turning off the electromagnetic contactor after the drive stops.	600 s (0 - 6000 s)

◆ **b9: Zero Servo**

Zero Servo is a position control function that stops and holds the motor shaft. The drive safeties the stopped motor and an external force will not move the motor.

When you enable the Zero Servo function, the drive will save the home position. The drive can correct the motor position and put the motor into the home position when the load rotates the motor.

To enable Zero Servo, set $H1-xx = 72$ [MFDI Function Selection = Zero Servo]. The drive starts Zero Servo when the MFDO terminal set for Zero Servo [$H1-xx = 72$] activates and the motor speed decreases to less than the value set in $b2-01$ [DC Injection/Zero SpeedThreshold]. The drive stops and holds the motor in the Zero Servo start position. When Zero Servo is enabled, the drive will hold the motor in position when the frequency reference increases to more than the value set in $b2-01$. When Zero Servo is enabled, the drive will hold the motor in position when the frequency reference increases to more than the value set in $b2-01$.

Note:

Zero Servo is available when $A1-02 = 3, 7$ [Control Method Selection = Closed Loop Vector, PM Closed Loop Vector].

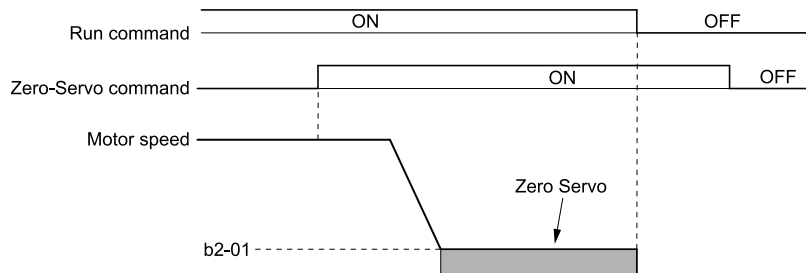

Figure 12.44 Zero Servo Time Chart

Monitor $U6-22$ [ZeroServoPulse Move] shows the difference between the position of the motor shaft and the Zero Servo start position when Zero Servo is enabled. To find the difference, divide the number of pulses shown in $U6-22$ by 4.

When the position of the motor shaft is in the range of “Zero Servo start position $\pm b9-02$ [Zero Servo Completion Window]”, the drive will activate an MFDO set for Zero Servo Complete [$H2-xx = 33$].

NOTICE: Do not let the Zero Servo function hold 100% load for long periods of time. When the application must use Zero Servo to hold 100% load for long periods, operate in less than 50% of the drive rated output current or use a larger capacity drive. If Zero Servo holds the load for too long in 50% or more of the drive rated output current, it will cause damage to the drive.

Note:

- When you use the Zero Servo function, keep the Run command ON. If the Run command is OFF, the drive will not hold the motor shaft in position.
- When you turn oFF the Zero-Servo command, the terminal set for Zero Servo Complete will deactivate.
- If $A1-02 = 7$ [PM Closed Loop Vector] and an external force rotates the motor during Zero Servo, the drive will detect $dv4$ [Inversion Prevention Detection]. To prevent $dv4$ detection, increase $b9-01$ [Zero Servo Gain] or increase the number of pulses set in $F1-19$ [Deviation 4 Detection Selection].

■ **b9-01: Zero Servo Gain**

No. (Hex.)	Name	Description	Default (Range)
b9-01 (01DA)	Zero Servo Gain	<div style="display: flex; justify-content: space-between; font-size: small;"> V/f CL-V/f OLV CLV AOLV OLV/PM AOLV/PM CLV/PM EZOLV </div> Sets the responsiveness for the Zero Servo function.	5 (0 - 100)

If the drive is not responsive, or if there is too much deviation from the Zero Servo start point when you increase the load, increase this setting. If oscillation or hunting occurs, decrease this setting.

Note:

- Set $C5-xx$ [Automatic Speed Regulator (ASR)] parameters correctly before you adjust the Zero Servo gain.
- When you operate with the Zero Servo command enabled, oscillation and hunting must not occur.

■ **b9-02: Zero Servo Completion Window**

No. (Hex.)	Name	Description	Default (Range)
b9-02 (01DB)	Zero Servo Completion Window	<div style="display: flex; justify-content: space-between; font-size: small;"> V/f CL-V/f OLV CLV AOLV OLV/PM AOLV/PM CLV/PM EZOLV </div> Sets the range to trigger an output terminal set for “Zero Servo Complete” during Zero Servo operation. Be sure to set the deviation from the Zero Servo start position.	10 (0 - 16383)

When the position of the motor shaft is in the range of “Zero Servo start position $\pm b9-02$ ”, the drive will activate a MFDO set for *Zero Servo Complete* [$H2-xx = 33$].

12.4 C: Tuning

C parameters adjust drive operation, including:

- Acceleration Time
- Deceleration Time
- Slip Compensation
- Torque Compensation
- Carrier Frequency

◆ C1: Accel & Decel Time

You can set four different acceleration and deceleration time pairs in the drive. When you activate and deactivate H1-xx = 7, 16, 1A [MFDI Function Select = Accel/Decel Time Selection 1, Motor 2 Selection, Accel/Decel Time Selection 2], you can switch acceleration and deceleration times during run.

Acceleration time parameters always set the time to accelerate from 0 Hz to *E1-04* [Maximum Output Frequency]. Deceleration time parameters always set the time to decelerate from *E1-04* to 0 Hz.

C1-01 [Acceleration Time 1] and *C1-02* [Deceleration Time 1] are the default active accel/decel settings.

Parameter	Range
C1-01 [Acceleration Time 1]	0.0 to 6000.0 s
C1-02 [Deceleration Time 1]	
C1-03 [Acceleration Time 2]	
C1-04 [Deceleration Time 2]	
C1-05 [Acceleration Time 3]	
C1-06 [Deceleration Time 3]	
C1-07 [Acceleration Time 4]	
C1-08 [Deceleration Time 4]	

Note:

The setting range for acceleration and deceleration times is 0.00 to 600.00 s when *C1-10* = 0 [Accel/Decel Time Setting Units = 0.01 s (0.00 to 600.00 s)].

■ Use MFDIs to Switch Acceleration Times

Table 12.33 shows the different acceleration and deceleration times.

Table 12.33 Accel/Decel Times and Active Parameters

H1-xx = 7 [Accel/Decel Time Selection 1]	H1-xx = 1A [Accel/Decel Time Selection 2]	Active Parameter	
		Acceleration Time	Deceleration Time
OFF	OFF	C1-01 [Acceleration Time 1]	C1-02 [Deceleration Time 1]
ON	OFF	C1-03 [Acceleration Time 2]	C1-04 [Deceleration Time 2]
OFF	ON	C1-05 [Acceleration Time 3]	C1-06 [Deceleration Time 3]
ON	ON	C1-07 [Acceleration Time 4]	C1-08 [Deceleration Time 4]

Figure 12.45 an operation example to change acceleration and deceleration times. It is necessary to set *b1-03* = 0 [Stopping Method Selection = Ramp to Stop] for this example.

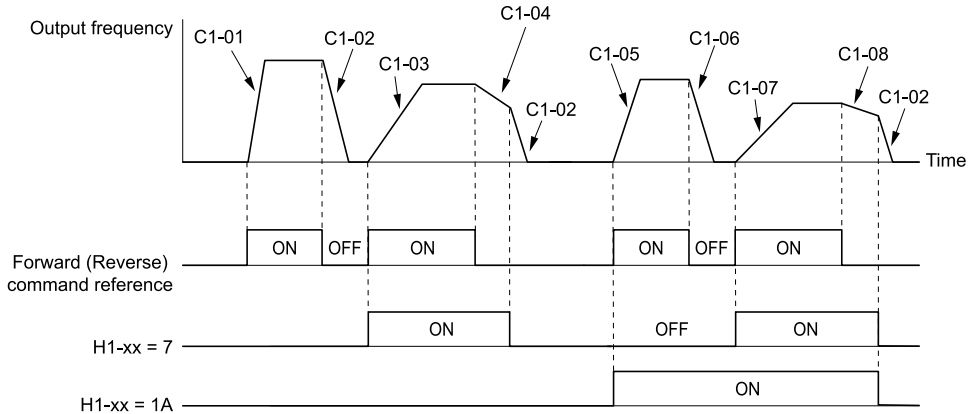

Figure 12.45 Timing Diagram of Acceleration and Deceleration Times

■ Use Motor Selection to Switch Acceleration and Deceleration Times

When you set $H1-xx = 16$ [MFDI Function Selection = Motor 2 Selection], you can activate and deactivate the input terminal to switch between motor 1 and motor 2.

Note:

You cannot use the Motor 2 Selection function with PM motors.

Table 12.34 shows the possible acceleration and deceleration time combinations when you use the Motor 2 Selection function.

Table 12.34 Motor Selection and Acceleration and Deceleration Times

H1-xx = 7 [Accel/Decel Time Selection 1]	H1-xx = 16 [Motor 2 Selection]			
	Motor 2 Selection: OFF		Motor 2 Selection: ON	
	Acceleration Time	Deceleration Time	Acceleration Time	Deceleration Time
OFF	C1-01	C1-02	C1-05	C1-06
ON	C1-03	C1-04	C1-07	C1-08

■ Use Output Frequency Level to Switch Acceleration and Deceleration Times

The drive can use output frequency to automatically switch between different acceleration and deceleration times. When the output frequency = $C1-11$ [Accel/Decel Time Switchover Freq], the drive automatically switches the acceleration and deceleration times. Set $C1-11 = 0.0$ Hz to disable this function.

Note:

- The acceleration and deceleration times set to MFDIs take higher priority than the automatic switch that uses the frequency level set in $C1-11$. For example, if you set the switchover frequency to $C1-11$, the drive will not automatically switch acceleration and deceleration times when $H1-xx = 7$ [Accel/Decel Time Selection 1] is activated.
- If Motor 2 Selection [$H1-xx = 16$] is activated, the drive will set the acceleration/deceleration time to $C1-05$ and $C1-06$ for motor 2 when the output frequency is more than the frequency level set in $C1-11$.

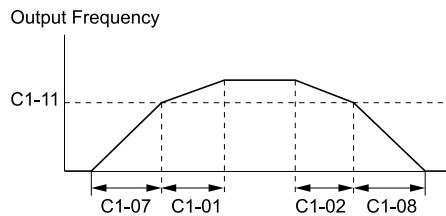

When the output frequency $\geq C1-11$, drive uses Accel/Decel Time 1(C1-01, C1-02)
 When the output frequency $< C1-11$, drive uses Accel/Decel Time 4(C1-07, C1-08)

Figure 12.46 Accel/Decel Time Switchover Freq

■ C1-01: Acceleration Time 1

No. (Hex.)	Name	Description	Default (Range)
C1-01 (0200) RUN	Acceleration Time 1	V/f CL-V/f OLV CLV AOLV OLV/PM AOLV/PM CLV/PM EZOLV Sets the length of time to accelerate from zero to maximum output frequency.	10.0 s (0.0 - 6000.0 s)

Note:

When $C1-10 = 0$ [Accel/Decel Time Setting Units = 0.01 s (0.00 to 600.00 s)], the setting range is 0.00 to 600.00 s.

■ C1-02: Deceleration Time 1

No. (Hex.)	Name	Description	Default (Range)
C1-02 (0201) RUN	Deceleration Time 1	V/f CL-V/f OLV CLV AOLV OLV/PM AOLV/PM CLV/PM EZOLV Sets the length of time to decelerate from maximum output frequency to zero.	10.0 s (0.0 - 6000.0 s)

Note:

When $C1-10 = 0$ [Accel/Decel Time Setting Units = 0.01 s (0.00 to 600.00 s)], the setting range is 0.00 to 600.00 s.

■ C1-03: Acceleration Time 2

No. (Hex.)	Name	Description	Default (Range)
C1-03 (0202) RUN	Acceleration Time 2	V/f CL-V/f OLV CLV AOLV OLV/PM AOLV/PM CLV/PM EZOLV Sets the length of time to accelerate from zero to maximum output frequency.	10.0 s (0.0 - 6000.0 s)

Note:

When $C1-10 = 0$ [Accel/Decel Time Setting Units = 0.01 s (0.00 to 600.00 s)], the setting range is 0.00 to 600.00 s.

■ C1-04: Deceleration Time 2

No. (Hex.)	Name	Description	Default (Range)
C1-04 (0203) RUN	Deceleration Time 2	V/f CL-V/f OLV CLV AOLV OLV/PM AOLV/PM CLV/PM EZOLV Sets the length of time to decelerate from maximum output frequency to zero.	10.0 s (0.0 - 6000.0 s)

Note:

When $C1-10 = 0$ [Accel/Decel Time Setting Units = 0.01 s (0.00 to 600.00 s)], the setting range is 0.00 to 600.00 s.

■ C1-05: Acceleration Time 3

No. (Hex.)	Name	Description	Default (Range)
C1-05 (0204) RUN	Acceleration Time 3	V/f CL-V/f OLV CLV AOLV OLV/PM AOLV/PM CLV/PM EZOLV Sets the length of time to accelerate from zero to maximum output frequency.	10.0 s (0.0 - 6000.0 s)

Note:

When $C1-10 = 0$ [Accel/Decel Time Setting Units = 0.01 s (0.00 to 600.00 s)], the setting range is 0.00 to 600.00 s.

■ C1-06: Deceleration Time 3

No. (Hex.)	Name	Description	Default (Range)
C1-06 (0205) RUN	Deceleration Time 3	V/f CL-V/f OLV CLV AOLV OLV/PM AOLV/PM CLV/PM EZOLV Sets the length of time to decelerate from maximum output frequency to zero.	10.0 s (0.0 - 6000.0 s)

Note:

When $C1-10 = 0$ [Accel/Decel Time Setting Units = 0.01 s (0.00 to 600.00 s)], the setting range is 0.00 to 600.00 s.

■ C1-07: Acceleration Time 4

No. (Hex.)	Name	Description	Default (Range)
C1-07 (0206) RUN	Acceleration Time 4	V/f CL-V/f OLV CLV AOLV OLV/PM AOLV/PM CLV/PM EZOLV Sets the length of time to accelerate from zero to maximum output frequency.	10.0 s (0.0 - 6000.0 s)

Note:

When $C1-10 = 0$ [Accel/Decel Time Setting Units = 0.01 s (0.00 to 600.00 s)], the setting range is 0.00 to 600.00 s.

■ **C1-08: Deceleration Time 4**

No. (Hex.)	Name	Description	Default (Range)
C1-08 (0207) RUN	Deceleration Time 4	V/f CL-V/f OLV CLV AOLV OLV/PM AOLV/PM CLV/PM EZOLV Sets the length of time to decelerate from maximum output frequency to zero.	10.0 s (0.0 - 6000.0 s)

Note:

When $C1-10 = 0$ [Accel/Decel Time Setting Units = 0.01 s (0.00 to 600.00 s)], the setting range is 0.00 to 600.00 s.

■ **C1-09: Fast Stop Time**

No. (Hex.)	Name	Description	Default (Range)
C1-09 (0208) RUN	Fast Stop Time	V/f CL-V/f OLV CLV AOLV OLV/PM AOLV/PM CLV/PM EZOLV Sets the length of time that the drive will decelerate to zero for a Fast Stop.	10.0 s (0.0 - 6000.0 s)

Note:

- When $C1-10 = 0$ [Accel/Decel Time Setting Units = 0.01 s (0.00 to 600.00 s)], the setting range is 0.00 to 600.00 s.
- When $L2-29 = 0$ [Kinetic Energy Backup Method = Single Drive KEB Ride-Thru 1] and you do KEB Auto-Tuning, the drive will automatically set $C1-09$. If you must not change the Fast Stop time, do not do KEB Auto-Tuning.

The Fast Stop function will be triggered in the following circumstances.

- The Fast Stop operation will be triggered by the input of the Fast Stop command via the multi-function digital input terminal.
- The Fast Stop operation is will be triggered when by the input of the Fast Stop command is input via the multi-function digital input terminal.

Set $H1-xx = 15, 17$ [MFDI Function Select = Fast Stop (N.O.), Fast Stop (N.C.)].

When the Fast Stop command is input, the Fast Stop operation will be triggered at the deceleration time set to $C1-09$. The drive cannot be restarted after initiating a Fast Stop operation until deceleration is complete. Complete deceleration and cycle the Run command to clear the Fast Stop input.

The terminal set for $H2-xx = 4C$ [MFDO Function Select = During Fast Stop] will be ON during Fast Stop.

Note:

Decelerating too quickly can cause an *ov* [Overvoltage] fault that shuts off the drive while the motor to coasts to a stop. Set a Fast Stop time in $C1-09$ that prevents motor coasting and makes sure that the motor stops quickly and safely.

■ **C1-10: Accel/Decel Time Setting Units**

No. (Hex.)	Name	Description	Default (Range)
C1-10 (0209)	Accel/Decel Time Setting Units	V/f CL-V/f OLV CLV AOLV OLV/PM AOLV/PM CLV/PM EZOLV Sets the setting units for $C1-01$ to $C1-08$ [Accel/Decel Times 1 to 4], $C1-09$ [Fast Stop Time], $L2-06$ [Kinetic Energy Backup Decel Time], and $L2-07$ [Kinetic Energy Backup Accel Time].	1 (0, 1)

0 : 0.01 s (0.00 to 600.00 s)

Sets acceleration and deceleration times in 0.01 s units. The setting range is 0.0 to 6000.0 s.

If one of these parameters is set to 1000.0 s or longer, you cannot set $C1-10 = 0$:

- $C1-01$ to $C1-09$
- $L2-06$
- $L2-07$

When one of those parameters is set to a value between 600.1 s and 1000.0 s, you can set $C1-10 = 0$, but the time will change to 600.00 s.

1 : 0.1 s (0.0 to 6000.0 s)

Sets acceleration and deceleration times in 0.1 s units. The setting range is 0.0 to 6000.0 s.

■ **C1-11: Accel/Decel Time Switchover Freq**

No. (Hex.)	Name	Description	Default (Range)
C1-11 (020A)	Accel/Decel Time Switching Frequency	V/f CL-V/f OLV CLV AOLV OLV/PM AOLV/PM CLV/PM EZOLV Sets the frequency at which the drive will automatically change acceleration and deceleration times.	Determined by A1-02 (0.0 - 590.0 Hz)

When the output frequency is at the *C1-11* value, the drive automatically switches the acceleration and deceleration times. Set this parameter to *0.0* to disable this function.

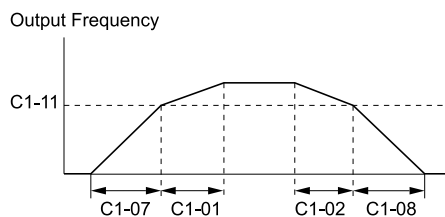

When the output frequency \geq C1-11, drive uses Accel/Decel Time 1 (C1-01, C1-02)
 When the output frequency $<$ C1-11, drive uses Accel/Decel Time 4 (C1-07, C1-08)

Figure 12.47 Accel/Decel Time Switchover Freq

Table 12.35 lists the possible combinations of acceleration and deceleration time switchover frequencies and the acceleration times for the Motor 2 Selection function.

Table 12.35 Motor and Acceleration and Deceleration Time Combination

C1-11	Motor 1		Motor 2	
	Acceleration Time	Deceleration Time	Acceleration Time	Deceleration Time
Less than the setting value	C1-07 [Acceleration Time 4]	C1-08 [Deceleration Time 4]	C1-07 [Acceleration Time 4]	C1-08 [Deceleration Time 4]
Equal to or more than the setting value	C1-01 [Acceleration Time 1]	C1-02 [Deceleration Time 1]	C1-05 [Acceleration Time 3]	C1-06 [Deceleration Time 3]

■ C1-14: Accel/Decel Rate Frequency

No. (Hex.)	Name	Description	Default (Range)
C1-14 (0264) RUN	Accel/Decel Rate Frequency	V/f CL-V/f OLV CLV AOLV OLV/PM AOLV/PM CLV/PM EZOLV Sets the base frequency used to calculate acceleration and deceleration rates.	0.0 Hz (0.0 - 590.0 Hz)

The acceleration and deceleration rates set in *C1-01* to *C1-09* [Acceleration/Deceleration Times 1 to 4, Fast Stop Time] will change when the value of *C1-14* changes.

- When *C1-14* = 0.0 Hz
 - *C1-01*, *C1-03*, *C1-05*, *C1-07* [Acceleration Times 1 to 4]: Time to accelerate from 0 Hz to *E1-04* [Maximum Output Frequency]
 - *C1-02*, *C1-04*, *C1-06*, *C1-08* [Deceleration Times 1 to 4], *C1-09* [Fast Stop Time]: Time to decelerate from *E1-04* to 0 Hz.

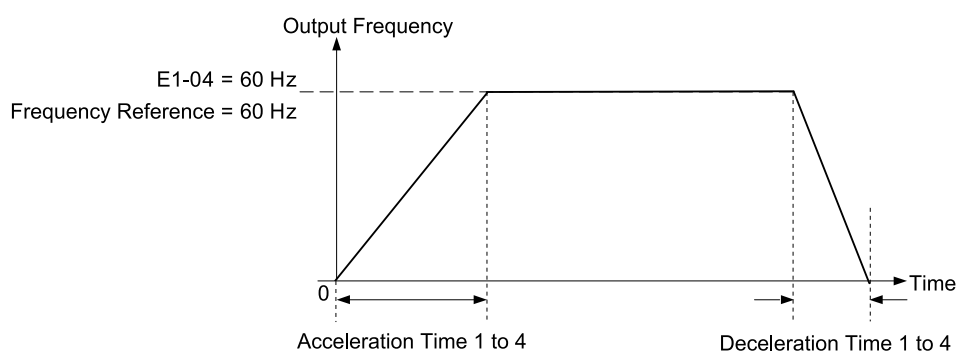

Figure 12.48 Example 1: Acceleration/Deceleration Rate (When C1-14 = 0 Hz, E1-04 = 60 Hz, and the Frequency Reference is 60 Hz)

- When *C1-14* \neq 0.0 Hz
 - *C1-01*, *C1-03*, *C1-05*, *C1-07*: Time to accelerate from 0 Hz to *C1-14*
 - *C1-02*, *C1-04*, *C1-06*, *C1-08*, *C1-09*: Time to decelerate from *C1-14* to 0 Hz

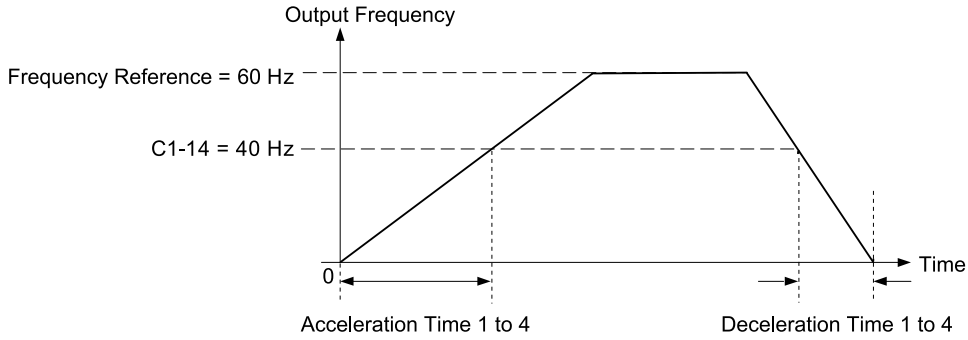

Figure 12.49 Example 2: Acceleration/Deceleration Rate (When C1-14 = 40 Hz, E1-04 = 60 Hz, and the Frequency Reference is 60 Hz)

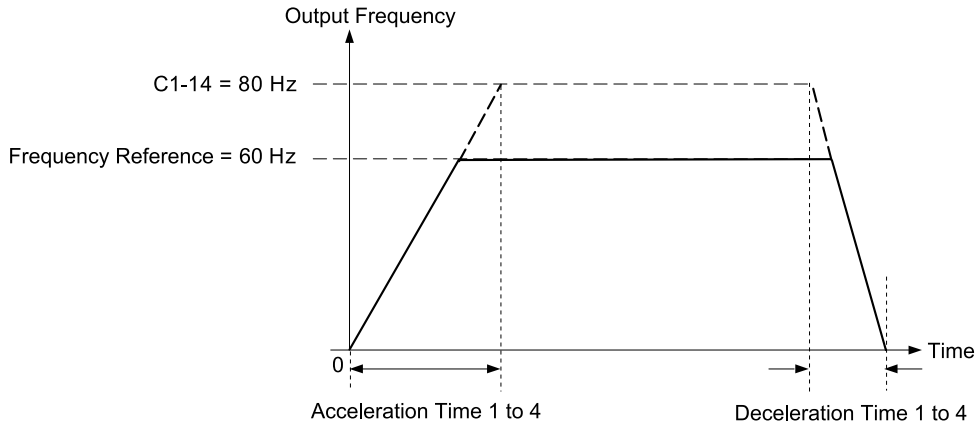

Figure 12.50 Example 3: Acceleration/Deceleration Rate (When C1-14 = 80 Hz, E1-04 = 60 Hz, and the Frequency Reference is 60 Hz)

Note:

- Figure 12.48 to Figure 12.50 show the accel/decel times when C2-01 to C2-04 [S-Curve Times @ Start/End of Accel/Decel] = 0.00 s.
- When L3-01 ≠ 0 [Stall Prevention during Accel ≠ Disabled], Stall Prevention could cause the acceleration time to be longer than the set value.
- When L3-04 ≠ 0 [Stall Prevention during Decel ≠ Disabled], Stall Prevention could cause the deceleration time to be longer than the set value.

◆ **C2: S-Curve Characteristics**

Use S-curve characteristics to smooth acceleration and deceleration and to minimize abrupt shock to the load. Set S-curve characteristic time during acceleration/deceleration at start and acceleration/deceleration at stop. The following figure explains how S-curves are applied.

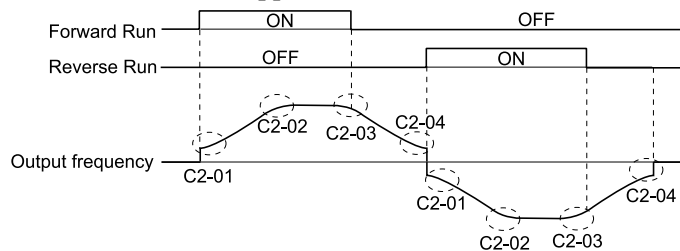

Figure 12.51 S-Curve Timing Diagram - Forward/Reverse Operation

Note:

- If STPo [Motor Step-Out Detected] occurs when starting a PM motor, try increasing the value set to C2-01.
- Setting the S-curve will increase the acceleration and deceleration times.

$$\text{Acceleration time} = \text{Selected acceleration time} + \frac{C2-01 + C2-02}{2}$$

$$\text{Deceleration time} = \text{Selected deceleration time} + \frac{C2-03 + C2-04}{2}$$

■ C2-01: S-Curve Time @ Start of Accel

No. (Hex.)	Name	Description	Default (Range)
C2-01 (020B)	S-Curve Time @ Start of Accel	V/f CL-V/f OLV CLV AOLV OLV/PM AOLV/PM CLV/PM EZOLV Sets the S-curve acceleration time at start.	Determined by A1-02 (0.00 - 10.00 s)

■ C2-02: S-Curve Time @ End of Accel

No. (Hex.)	Name	Description	Default (Range)
C2-02 (020C)	S-Curve Time @ End of Accel	V/f CL-V/f OLV CLV AOLV OLV/PM AOLV/PM CLV/PM EZOLV Sets the S-curve acceleration time at completion.	0.20 s (0.00 - 10.00 s)

■ C2-03: S-Curve Time @ Start of Decel

No. (Hex.)	Name	Description	Default (Range)
C2-03 (020D)	S-Curve Time @ Start of Decel	V/f CL-V/f OLV CLV AOLV OLV/PM AOLV/PM CLV/PM EZOLV Sets the S-curve deceleration time at start.	0.20 s (0.00 - 10.00 s)

■ C2-04: S-Curve Time @ End of Decel

No. (Hex.)	Name	Description	Default (Range)
C2-04 (020E)	S-Curve Time @ End of Decel	V/f CL-V/f OLV CLV AOLV OLV/PM AOLV/PM CLV/PM EZOLV Sets the S-curve deceleration time at completion.	0.00 s (0.00 - 10.00 s)

◆ C3: Slip Compensation

The Slip Compensation function improves the speed accuracy of an induction motor. As loads on induction motors increase, motor slip increases and motor speed decreases. By adjusting the output frequency in accordance with the motor load, it compensates the slip and makes the motor speed equal to the frequency reference.

■ C3-01: Slip Compensation Gain

No. (Hex.)	Name	Description	Default (Range)
C3-01 (020F) RUN	Slip Compensation Gain	V/f CL-V/f OLV CLV AOLV OLV/PM AOLV/PM CLV/PM EZOLV Sets the gain for the slip compensation function. Usually it is not necessary to change this setting.	Determined by A1-02 (0.0 - 2.5)

Note:

- When $A1-02 = 4$ [AOLV], you cannot change the setting while the drive is running.
- Correctly set these parameters before you change the slip compensation gain:
 - E2-01 [Motor Rated Current (FLA)]
 - E2-02 [Motor Rated Slip]
 - E2-03 [Motor No-Load Current]
- When $A1-02 = 3$ [Closed Loop Vector], the slip compensation gain becomes the motor temperature compensation gain. When the motor temperature increases, the motor internal constant changes and increases the slip. When you set this parameter, the drive adjusts the slip with the increase in temperature. Adjust this parameter in these conditions: When the setting value increases, the compensation also increases:
 - The drive is doing torque control.
 - There are torque limits.
 - Output torque changes when the temperature changes.

Adjust this parameter as follows if necessary:

- If the motor speed is slower than the frequency reference, increase C3-01 in 0.1-unit increments.
- If the motor speed is faster than the frequency reference, decrease C3-01 in 0.1-unit increments.

■ C3-02: Slip Compensation Delay Time

No. (Hex.)	Name	Description	Default (Range)
C3-02 (0210) RUN	Slip Compensation Delay Time	<input checked="" type="checkbox"/> V/f <input type="checkbox"/> CL-V/f <input checked="" type="checkbox"/> OLV <input type="checkbox"/> CLV <input type="checkbox"/> AOLV <input type="checkbox"/> OLV/PM <input type="checkbox"/> AOLV/PM <input type="checkbox"/> CLV/PM <input checked="" type="checkbox"/> EZOLV Sets the slip compensation delay time when speed is unstable or when the slip compensation response is too slow. Usually it is not necessary to change this setting.	Determined by A1-02 (0 - 10000 ms)

Use these settings to adjust this parameter as necessary:

- When the speed is not stable, increase the setting.
- When the slip compensation response is too slow, decrease the setting.

■ C3-03: Slip Compensation Limit

No. (Hex.)	Name	Description	Default (Range)
C3-03 (0211)	Slip Compensation Limit	<input checked="" type="checkbox"/> V/f <input type="checkbox"/> CL-V/f <input checked="" type="checkbox"/> OLV <input type="checkbox"/> CLV <input type="checkbox"/> AOLV <input type="checkbox"/> OLV/PM <input type="checkbox"/> AOLV/PM <input type="checkbox"/> CLV/PM <input checked="" type="checkbox"/> EZOLV Sets the upper limit for the slip compensation function as a percentage of the motor rated slip.	200% (0 - 250%)

If you increase the value of C3-01 [Slip Compensation Gain] and the motor speed is slow, use this parameter. The drive uses this parameter when the slip is at the upper limit of slip compensation. Make sure that you measure the motor speed when you increase this parameter value. Set this parameter to make the frequency reference and the slip compensation limit less than the permitted range of the machine.

The slip compensation limit is constant in the constant torque range (frequency reference \leq E1-06 [Base Frequency]). In the constant output range where the frequency reference $>$ E1-06, the slip compensation limit increases with the C3-03 value and the output frequency as shown in Figure 12.52.

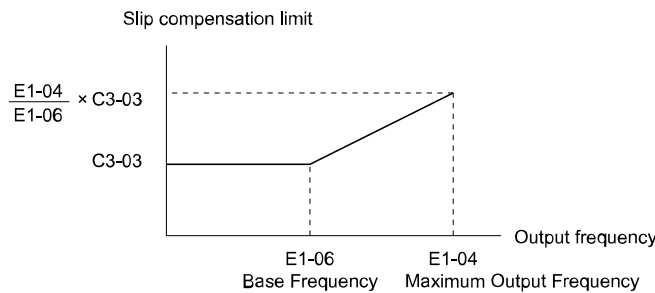

Figure 12.52 Slip Compensation Limit

■ C3-04: Slip Compensation at Regen

No. (Hex.)	Name	Description	Default (Range)
C3-04 (0212)	Slip Compensation at Regen	<input checked="" type="checkbox"/> V/f <input type="checkbox"/> CL-V/f <input checked="" type="checkbox"/> OLV <input type="checkbox"/> CLV <input type="checkbox"/> AOLV <input type="checkbox"/> OLV/PM <input type="checkbox"/> AOLV/PM <input type="checkbox"/> CLV/PM <input checked="" type="checkbox"/> EZOLV Sets the slip compensation function during regeneration.	0 (0 - 2)

If you apply a regenerative load when the slip compensation function during regeneration is active, the quantity of regeneration can increase immediately. In this condition, it is necessary to use a dynamic braking option (braking resistor or braking resistor unit).

0 : Disabled

The drive will not do Slip compensation during regeneration.

The load and operation status (regenerative operation) can cause the motor speed to be higher or lower than the frequency reference.

1 : Enabled Above 6Hz

Slip compensation function is enabled during regeneration. Slip compensation is disabled at output frequencies of 6 Hz or less.

2 : Enabled Above Defined Range

The drive uses E2-02 [Motor Rated Slip] to automatically calculate the frequency range where it will disable slip compensation function during regenerative operation.

Slip compensation is enabled at frequencies as low as 2 Hz.

■ C3-05: Output Voltage Limit Selection

No. (Hex.)	Name	Description	Default (Range)
C3-05 (0213)	Output Voltage Limit Selection	<input type="checkbox"/> V/f <input type="checkbox"/> CL-V/f <input checked="" type="checkbox"/> OLV <input checked="" type="checkbox"/> CLV <input type="checkbox"/> AOLV <input type="checkbox"/> OLV/PM <input type="checkbox"/> AOLV/PM <input type="checkbox"/> CLV/PM <input type="checkbox"/> EZOLV Sets the automatic reduction of motor magnetic flux when the output voltage is saturated.	0 (0, 1)

The drive will decrease flux and increase current to compensate torque when voltage is saturated. Make sure that the drive has sufficient output current capacity before you enable this parameter. When this parameter = 1 [Enabled], the output current will increase by 10% at a maximum (at rated load) before it is enabled.

Enable this parameter to increase speed precision when you move heavy loads at high speeds in these conditions:

- Power supply voltage is low
- Motor rated voltage is high

Do not enable this parameter in these conditions:

- Operating a motor in the middle speed range or low speed range
- Power supply voltage is a minimum of 10% more than the motor rated voltage

When you enable this parameter, if the power supply voltage is much less than the motor rated voltage, torque control will not be accurate.

0 : Disabled

1 : Enabled

■ C3-16: Vout Modulation Limit Start Lvl

No. (Hex.)	Name	Description	Default (Range)
C3-16 (0261) Expert	Vout Modulation Limit Start Lvl	<input type="checkbox"/> V/f <input type="checkbox"/> CL-V/f <input checked="" type="checkbox"/> OLV <input checked="" type="checkbox"/> CLV <input type="checkbox"/> AOLV <input type="checkbox"/> OLV/PM <input type="checkbox"/> AOLV/PM <input type="checkbox"/> CLV/PM <input type="checkbox"/> EZOLV Sets the modulation factor that starts the output voltage limit operation when C3-05 = 1 [Output Voltage Limit Selection = Enabled].	90.0% (70.0 - 90.0%)

■ C3-17: Vout Modulation Limit Max Level

No. (Hex.)	Name	Description	Default (Range)
C3-17 (0262) Expert	Vout Modulation Limit Max Level	<input type="checkbox"/> V/f <input type="checkbox"/> CL-V/f <input checked="" type="checkbox"/> OLV <input checked="" type="checkbox"/> CLV <input type="checkbox"/> AOLV <input type="checkbox"/> OLV/PM <input type="checkbox"/> AOLV/PM <input type="checkbox"/> CLV/PM <input type="checkbox"/> EZOLV Sets the modulation factor used with C3-18 [Output Voltage Limit Level] for the output voltage limit operation when C3-05 = 1 [Output Voltage Limit Selection = Enabled].	100.0% (85.0 - 100.0%)

■ C3-18: Output Voltage Limit Level

No. (Hex.)	Name	Description	Default (Range)
C3-18 (0263) Expert	Output Voltage Limit Level	<input type="checkbox"/> V/f <input type="checkbox"/> CL-V/f <input checked="" type="checkbox"/> OLV <input checked="" type="checkbox"/> CLV <input type="checkbox"/> AOLV <input type="checkbox"/> OLV/PM <input type="checkbox"/> AOLV/PM <input type="checkbox"/> CLV/PM <input type="checkbox"/> EZOLV Sets the maximum drop width of the voltage reference when C3-05 = 1 [Output Voltage Limit Selection = Enabled].	90.0% (50.0 - 100.0%)

■ C3-21: Motor 2 Slip Compensation Gain

No. (Hex.)	Name	Description	Default (Range)
C3-21 (033E) RUN	Motor 2 Slip Compensation Gain	<input type="checkbox"/> V/f <input type="checkbox"/> CL-V/f <input checked="" type="checkbox"/> OLV <input checked="" type="checkbox"/> CLV <input type="checkbox"/> AOLV <input type="checkbox"/> OLV/PM <input type="checkbox"/> AOLV/PM <input type="checkbox"/> CLV/PM <input type="checkbox"/> EZOLV Sets the gain for the motor 2 slip compensation function. Usually it is not necessary to change this setting.	Determined by E3-01 (0.0 - 2.5)

Note:

Correctly set these parameters before you change the slip compensation gain:

- E4-01 [Motor 2 Rated Current]
- E4-02 [Motor 2 Rated Slip]
- E4-03 [Motor 2 Rated No-Load Current]

Adjust this parameter as follows if necessary:

- If the motor speed is slower than the frequency reference, increase C3-01 in 0.1-unit increments.
- If the motor speed is faster than the frequency reference, decrease C3-01 in 0.1-unit increments.

■ C3-22: Motor 2 Slip Comp Delay Time

No. (Hex.)	Name	Description	Default (Range)
C3-22 (0241) RUN	Motor 2 Slip Comp Delay Time	<input checked="" type="checkbox"/> V/f <input type="checkbox"/> CL-V/f <input checked="" type="checkbox"/> OLV <input type="checkbox"/> CLV <input type="checkbox"/> AOLV <input type="checkbox"/> OLV/PM <input type="checkbox"/> AOLV/PM <input type="checkbox"/> CLV/PM <input type="checkbox"/> EZOLV Sets the slip compensation delay time for motor 2 when speed is unstable or when the slip compensation response is too slow. Usually it is not necessary to change this setting.	Determined by E3-01 (0 - 10000 ms)

Use these settings to adjust this parameter as necessary:

- When the speed is not stable, increase the setting.
- When the slip compensation response is too slow, decrease the setting.

■ C3-23: Motor 2 Slip Compensation Limit

No. (Hex.)	Name	Description	Default (Range)
C3-23 (0242)	Motor 2 Slip Compensation Limit	<input checked="" type="checkbox"/> V/f <input type="checkbox"/> CL-V/f <input checked="" type="checkbox"/> OLV <input type="checkbox"/> CLV <input type="checkbox"/> AOLV <input type="checkbox"/> OLV/PM <input type="checkbox"/> AOLV/PM <input type="checkbox"/> CLV/PM <input type="checkbox"/> EZOLV Sets the upper limit for the slip compensation function as a percentage of the motor 2 rated slip.	200% (0 - 250%)

If you increase the value of C3-21 [Motor 2 Slip Compensation Gain] and the motor speed is slow, use this parameter. The drive uses this parameter when the slip is at the upper limit of slip compensation. Make sure that you measure the motor speed when you increase this parameter value. Set this parameter to make the frequency reference and the slip compensation limit less than the permitted range of the machine.

The slip compensation limit is constant in the constant torque range (frequency reference \leq E3-06 [Motor 2 Base Frequency]). In the constant power range where the frequency reference $>$ E3-06, the slip compensation limit increases with the C3-23 value and the output frequency as shown in Figure 12.53.

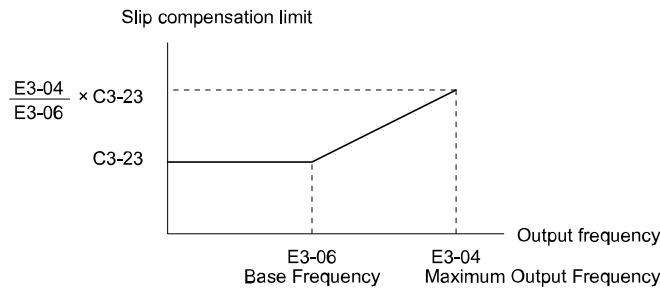

Figure 12.53 Motor 2 Slip Compensation Limit

■ C3-24: Motor 2 Slip Comp during Regen

No. (Hex.)	Name	Description	Default (Range)
C3-24 (0243)	Motor 2 Slip Comp during Regen	<input checked="" type="checkbox"/> V/f <input type="checkbox"/> CL-V/f <input checked="" type="checkbox"/> OLV <input type="checkbox"/> CLV <input type="checkbox"/> AOLV <input type="checkbox"/> OLV/PM <input type="checkbox"/> AOLV/PM <input type="checkbox"/> CLV/PM <input type="checkbox"/> EZOLV Sets the slip compensation during regenerative operation function for motor 2.	0 (0 - 2)

If you apply a regenerative load when the slip compensation function during regeneration is active, the quantity of regeneration can increase immediately. In this condition, it is necessary to use a dynamic braking option (braking resistor or braking resistor unit).

0 : Disabled

The drive will not do Slip compensation during regeneration.

The load and operation status (regenerative operation) can cause the motor speed to be higher or lower than the frequency reference.

1 : Enabled Above 6Hz

Slip compensation function is enabled during regeneration. Slip compensation is disabled at output frequencies of 6 Hz or less.

2 : Enabled Above Defined Range

The drive uses E2-02 [Motor Rated Slip] to automatically calculate the frequency range where it will disable slip compensation function during regenerative operation.

Slip compensation is enabled at frequencies as low as 2 Hz.

■ C3-28: Adaptive Slip Control Mode

No. (Hex.)	Name	Description	Default (Range)
C3-28 (1B5B) Expert	Adaptive Slip Control Mode	<div style="display: flex; justify-content: space-between; font-size: 0.8em;"> V/f CL-V/f OLV CLV AOLV OLV/PM AOLV/PM CLV/PM EZOLV </div> Sets the slip compensation function mode.	0 (0, 1)

0 : Normal

1 : Advanced

Note:

Set $C3-28 = 0$ for better torque precision. If the torque precision does is not better, set $C3-28 = 1$ and increase the value of $n4-65$ [Flux Estimate Response@High Freq] or $n4-66$ [Flux Estimate Response @Low Freq] in 0.1-unit increments. Then, you must do Rotational Auto-Tuning.

◆ C4: Torque Compensation

Torque compensation is a function that increases voltage to increase output torque as compensation for insufficient torque production at start-up or low-speed operation.

Voltage drops due to motor winding resistance cause torque generating voltage to decrease, which causes insufficient torque. If the main circuit cable connecting the drive and motor is long, this can also cause insufficient torque due to voltage drops.

Note:

Set the motor parameters and V/f pattern properly before setting $C4$ parameters.

■ C4-01: Torque Compensation Gain

No. (Hex.)	Name	Description	Default (Range)
C4-01 (0215) RUN	Torque Compensation Gain	<div style="display: flex; justify-content: space-between; font-size: 0.8em;"> V/f CL-V/f OLV CLV AOLV OLV/PM AOLV/PM CLV/PM EZOLV </div> Sets the gain for the torque compensation function. Use this parameter value for motor 1 when operating multiple motors.	Determined by A1-02 (0.00 - 2.50)

Adjust the setting in these control methods and conditions:

A1-02 [Control Method Selection]	Status	Adjustment
0 [V/f Control] 1 [V/f Control with Encoder] 8 [EZ Vector Control]	Torque is not sufficient during low-speed operation of 10 Hz or less.	Increase the setting in 0.05-unit increments.
	There is vibration in the motor when operating the drive with a light load.	Decrease the setting in 0.05-unit decrements.
	The cable between the drive and motor is too long.	Increase the setting in 0.05-unit increments.

Note:

- Adjust $C4-01$ to make sure that the output current is not more than the drive rated current during low-speed operation.
- When $A1-02 = 2$ [Open Loop Vector], usually it is not necessary to change this setting. If you change this parameter in that control method, it can decrease the torque precision.
- When $A1-02 = 5$ [PM Open Loop Vector], usually it is not necessary to change this setting. Setting this value too high can cause overcompensation and motor oscillation.
- When $A1-02 = 8$ [EZ Vector Control], you cannot change the setting while the drive is running.

■ C4-02: Torque Compensation Delay Time

No. (Hex.)	Name	Description	Default (Range)
C4-02 (0216) RUN	Torque Compensation Delay Time	<div style="display: flex; justify-content: space-between; font-size: 0.8em;"> V/f CL-V/f OLV CLV AOLV OLV/PM AOLV/PM CLV/PM EZOLV </div> Sets the torque compensation delay time. Usually it is not necessary to change this setting.	Determined by A1-02 (0 - 60000 ms)

Note:

- When $A1-02 = 5$ [Control Method Selection = OLV/PM], you cannot change the setting while the drive is running.
- When $A1-02 = 8$ [EZOLV], you cannot change the setting while the drive is running.

Set this parameter in these conditions:

- If there is vibration in the motor, increase the setting.
- If the motor speed or motor torque response is too slow, decrease the setting.

■ C4-03: Torque Compensation @ FWD Start

No. (Hex.)	Name	Description	Default (Range)
C4-03 (0217)	Torque Compensation @ FWD Start	<div style="display: flex; justify-content: space-between; font-size: 0.8em;"> V/f CL-V/f OLV CLV AOLV OLV/PM AOLV/PM CLV/PM EZOLV </div> Set the amount of torque reference for forward start as a percentage of the motor rated torque.	0.0% (0.0 - 200.0%)

The torque compensation function is performed using the time constant set in *C4-05 [Torque Compensation Time]*.

This is available only when you start the motor with the forward command. Set this parameter to 0.0 to disable this function.

■ C4-04: Torque Compensation @ REV Start

No. (Hex.)	Name	Description	Default (Range)
C4-04 (0218)	Torque Compensation @ REV Start	<div style="display: flex; justify-content: space-between; font-size: 0.8em;"> V/f CL-V/f OLV CLV AOLV OLV/PM AOLV/PM CLV/PM EZOLV </div> Sets the amount of torque reference for reverse start as a percentage of the motor rated torque.	0.0% (-200.0 - 0.0%)

The drive uses the time constant set in *C4-05 [Torque Compensation Time]* to do the torque compensation function.

This is available only when you start the motor with the reverse Run command.

■ C4-05: Torque Compensation Time

No. (Hex.)	Name	Description	Default (Range)
C4-05 (0219)	Torque Compensation Time	<div style="display: flex; justify-content: space-between; font-size: 0.8em;"> V/f CL-V/f OLV CLV AOLV OLV/PM AOLV/PM CLV/PM EZOLV </div> Sets the starting torque constant to use with <i>C4-03</i> and <i>C4-04 [Torque Compensation @ FWD/REV Start]</i> .	10 ms (0 - 200 ms)

■ C4-06: Motor 2 Torque Comp Delay Time

No. (Hex.)	Name	Description	Default (Range)
C4-06 (021A)	Motor 2 Torque Comp Delay Time	<div style="display: flex; justify-content: space-between; font-size: 0.8em;"> V/f CL-V/f OLV CLV AOLV OLV/PM AOLV/PM CLV/PM EZOLV </div> Sets the value if <i>ov [Overvoltage]</i> occurs with sudden changes in the load, at the end of acceleration, or at the start of deceleration.	150 ms (0 - 10000 ms)

Sets the time constant used during Speed Search or during regenerative operation when *ov* occurs.

Adjust this parameter in the following circumstances.

- Gradually reduce the setting in 10 ms increments and check the performance to improve motor torque speed response when *ov* occurs.

Note:

- Ensure that $C4-06 \geq C4-02$ [*Torque Compensation Delay Time*].
- Increase the setting value of $n2-03$ [*Automatic Freq Regulator Time 2*] proportional to *C4-06*.

■ C4-07: Motor 2 Torque Compensation Gain

No. (Hex.)	Name	Description	Default (Range)
C4-07 (0341) RUN	Motor 2 Torque Compensation Gain	<div style="display: flex; justify-content: space-between; font-size: 0.8em;"> V/f CL-V/f OLV CLV AOLV OLV/PM AOLV/PM CLV/PM EZOLV </div> Sets the gain for motor 2 torque compensation function when using the Motor Switch function.	1.00 (0.00 - 2.50)

In V/f Control or CL-V/f Control, adjust the value in 0.05 unit increments for these conditions:

- When torque is not sufficient during low-speed operation of 10 Hz or less, increase the setting value
- When there is vibration in the motor or when the motor hunts when operating the drive with a light load, decrease the setting value
- When you use a long motor cable, increase the setting.

Note:

- Adjust *C4-07* and make sure that the output current is not more than the drive rated current during low-speed operation.
- When $A1-02 = 2$ [*Open Loop Vector*], usually it is not necessary to change this setting. If you change this parameter in that control method, it can decrease the torque precision.

■ C4-19: Torque Ripple Suppress Min Freq

No. (Hex.)	Name	Description	Default (Range)
C4-19 (0B8D) Expert	Torque Ripple Suppress Min Freq	<div style="display: flex; justify-content: space-between; font-size: 0.8em;"> V/f CL-V/f OLV CLV AOLV OLV/PM AOLV/PM CLV/PM EZOLV </div> <p>If there is slow oscillation at low speeds, adjust this setting. Usually it is not necessary to change this setting.</p>	0.1 Hz (0.0 - 10.0 Hz)

Note:

Set C4-20 [Voltage Compensation Adjust 1] $\neq 0$ to enable this parameter.

■ C4-20: Voltage Compensation Adjust 1

No. (Hex.)	Name	Description	Default (Range)
C4-20 (0BCB) Expert	Voltage Compensation Adjust 1	<div style="display: flex; justify-content: space-between; font-size: 0.8em;"> V/f CL-V/f OLV CLV AOLV OLV/PM AOLV/PM CLV/PM EZOLV </div> <p>Sets voltage precision compensation. Usually it is not necessary to change this setting.</p>	120 Hz (0 - 200 Hz)

Note:

Set C4-20 = 0 when noise occurs during low-speed operation.

■ C4-21: Voltage Compensation Adjust 2

No. (Hex.)	Name	Description	Default (Range)
C4-21 (0BCC) Expert	Voltage Compensation Adjust 2	<div style="display: flex; justify-content: space-between; font-size: 0.8em;"> V/f CL-V/f OLV CLV AOLV OLV/PM AOLV/PM CLV/PM EZOLV </div> <p>Sets voltage precision compensation. Usually it is not necessary to change this setting.</p>	5 (0 - 10)

Note:

Set C4-21 = 0 when noise occurs during high-speed operation.

■ C4-23: Current Control Gain

No. (Hex.)	Name	Description	Default (Range)
C4-23 (1583) Expert	Current Control Gain	<div style="display: flex; justify-content: space-between; font-size: 0.8em;"> V/f CL-V/f OLV CLV AOLV OLV/PM AOLV/PM CLV/PM EZOLV </div> <p>Sets the Current control gain. Usually it is not necessary to change this parameter.</p>	1.00 (0.50 - 2.50)

■ C4-25: High-Speed Voltage Compensation

No. (Hex.)	Name	Description	Default (Range)
C4-25 (1BF4) Expert	High-Speed Voltage Compensation	<div style="display: flex; justify-content: space-between; font-size: 0.8em;"> V/f CL-V/f OLV CLV AOLV OLV/PM AOLV/PM CLV/PM EZOLV </div> <p>Sets the voltage compensation function for high-speed operation. Usually it is not necessary to change this setting.</p>	Determined by A1-02 (0, 1)

0 : Disabled

1 : Enabled

Note:

Set C4-25 = 0 when there is audible noise or motor vibration during high-speed operation.

◆ C5: Automatic Speed Regulator (ASR: Automatic Speed Regulator)

The ASR adjusts the output frequency or torque reference to decrease the difference between frequency reference and motor speed. The control method sets the parameter that you must adjust.

A1-02 [Control Method Selection]	Targets of Adjustment
1: Closed Loop V/f Control (CL-V/f)	Output frequency
<ul style="list-style-type: none"> • 3: Closed Loop Vector Control (CLV) • 4: Advanced Open Loop Vector Control (AOLV) • 6: PM Advanced Open Loop Vector (AOLV/PM) • 7: Closed Loop Vector Control for PM (CLV/PM) • 8: EZ Vector Control (EZOLV) 	Torque Reference

Figure 12.54 and Figure 12.55 are speed control block diagrams of each control method.

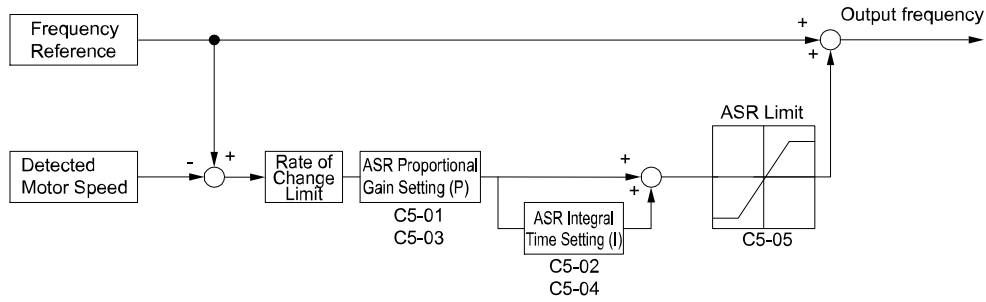

Figure 12.54 Speed Control Block Diagram for CL-V/f

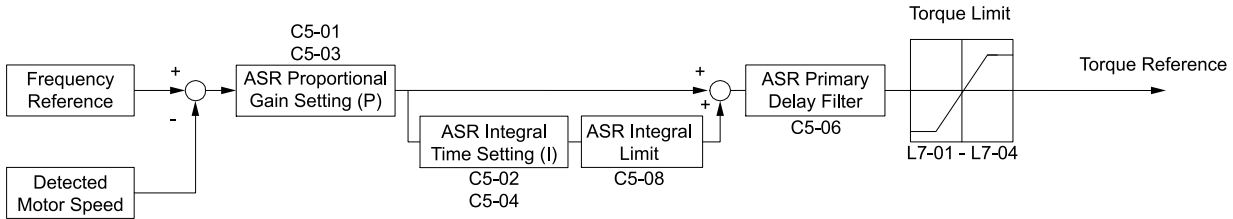

Figure 12.55 Speed Control Block Diagram for CLV, AOLV, CLV/PM, AOLV/PM, and EZOLV

Note:

The detected speed is the speed estimation value when configured such that A1-02 = 4, 6, or 8 [Control Method Selection = AOLV, AOLV/PM, or EZOLV].

■ Before You Adjust ASR Parameters

- Do Auto-Tuning and set up all motor data correctly before you adjust the ASR parameters.
- Always make adjustments with the load connected to the motor.
- Use analog output signals to monitor U1-16 [SFS Output Frequency] and U1-05 [Motor Speed] when you adjust the ASR.

■ ASR Adjustment Procedure for CL-V/f

Do this procedure to adjust ASR parameters:

1. Run the motor at minimum speed and increase C5-03 [ASR Proportional Gain 2] as much as possible without oscillation.

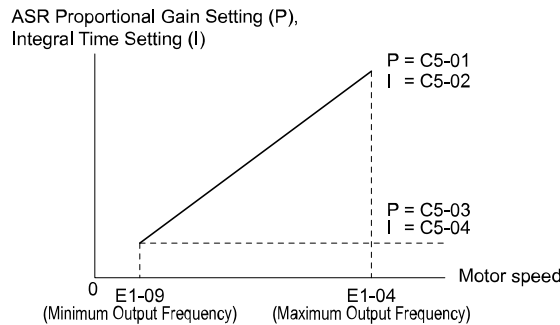

Figure 12.56 ASR Gain and Integral Time Adjustment

2. Run the motor at minimum speed and decrease C5-04 [ASR Integral Time 2] as much as possible without oscillation.
3. Check the output current monitor to make sure that the output current is less than 50% of the drive rated current. If the setting value is higher than 50%, decrease C5-03 and increase C5-04.
4. Run the motor at maximum speed and increase C5-01 [ASR Proportional Gain 1] as much as possible without oscillations.
5. Run the motor at maximum speed and decrease C5-02 [ASR Integral Time 1] as much as possible without oscillations.
6. If higher speed precision and faster response during acceleration or deceleration are necessary, set C5-12 = 1 [Integral Operation @ Accel/Decel = Enabled] to enable integral control during acceleration/decel.

Note:

- If overshooting occurs when acceleration ends, decrease the value set in C5-01 and increase the value set in C5-02.
- If undershoot occurs at stop, decrease C5-03 and increase C5-04.
- If you adjust the gain and it does not correct overshooting and undershooting, decrease the value set in C5-05 [ASR Limit] to decrease the upper limit of the frequency reference compensation.

■ ASR Adjustment Procedure for CLV, AOLV, AOLV/PM, CLV/PM, and EZOLV

Do this procedure to adjust ASR parameters:

1. Run the motor at zero speed or low speed and increase C5-01 [ASR Proportional Gain 1] until immediately before vibration starts to occur.
2. Run the motor at zero speed or low speed and decrease C5-02 [ASR Integral Time 1] until immediately before vibration starts to occur.
3. Check for oscillation when you run the motor at maximum speed.
4. If oscillation occurs, increase C5-02 and decrease C5-01.
When there is no oscillation, the adjustment procedure is complete.
5. Set the low-speed gain. Run the motor at zero speed or low speed and increase C5-03 [ASR Proportional Gain 2] until immediately before vibration starts to occur.

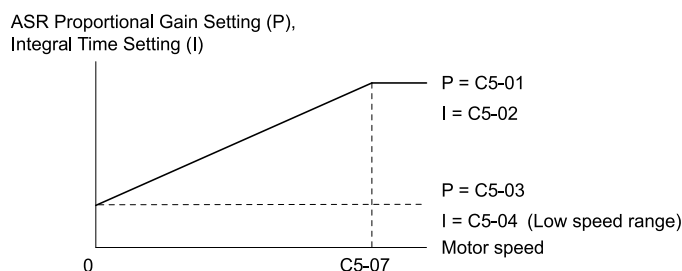

Figure 12.57 Low-speed/High-speed Gain Settings

6. Set the low-speed integral time. Run the motor at zero speed or low speed and decrease C5-04 [ASR Integral Time 2] until immediately before vibration starts to occur.
7. Set C5-07 [ASR Gain Switchover Frequency].
8. Check for oscillation when you run the motor at speeds more than the setting in C5-07.

Note:

- If overshooting occurs when acceleration ends, decrease the value set in C5-01 and increase the value set in C5-02.
- If undershoot occurs at stop, decrease C5-03 and increase C5-04.

■ Use MFDI Switch for Proportional Gain

Note:

If A1-02 = 1 [Control Method Selection = V/f Control with Encoder], you cannot use this function.

You can use the input terminals set for H1-xx = 77 [ASR Gain (C5-03) Select] to switch the proportional gains set with C5-01 [ASR Proportional Gain 1] and C5-03 [ASR Proportional Gain 2]. When the configured input terminal deactivates, it selects the proportional gain set for C5-01. When the terminal is activated, the proportional gain set for C5-03 is selected. The proportional gain changes linearly over the time set in C5-02 [ASR Integral Time 1]. The signals from this MFDI are more important than C5-07 [ASR Gain Switchover Frequency].

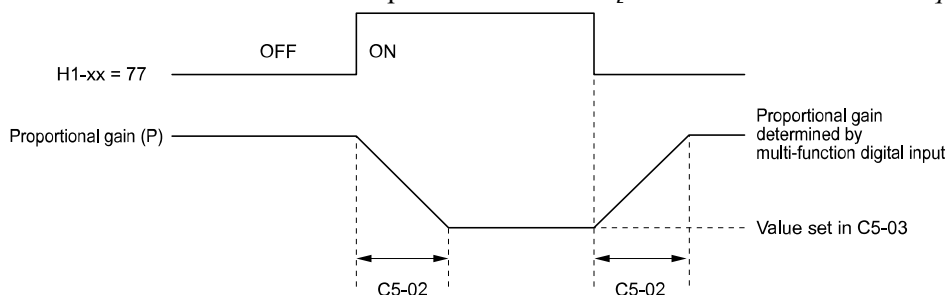

Figure 12.58 Proportional Gain through Multi-function Digital Input Switch

■ Speed Waveform Monitoring Method

To make small adjustments of ASR parameters, monitor the speed waveforms when you make the adjustments. Table 12.36 shows example settings of parameters to monitor speed waveforms.

Table 12.36 Example Settings of MFAO Terminals to Monitor Speed Waveforms

No.	Name	Setting Value	Description
H4-01	Terminal FM Analog Output Select	116	Lets you use terminal FM to monitor U1-16 [SFS Output Frequency].
H4-02	Terminal FM Analog Output Gain	100.0%	
H4-03	Terminal FM Analog Output Bias	0.0%	
H4-04	Terminal AM Analog Output Select	105	Lets you use terminal AM to monitor U1-05 [Motor Speed].
H4-05	Terminal AM Analog Output Gain	50.0%	
H4-06	Terminal AM Analog Output Bias	0.0%	
H4-07	Terminal FM Signal Level Select	1	Lets you monitor in a -10 V to +10 V range.
H4-08	Terminal AM Signal Level Select	1	

These settings cause this MFAO configuration. The MFAO common is terminal AC:

- Terminal FM: Outputs the output frequency after SFS in a -10 V to +10 V (-100% to +100%) range.
- Terminal AM: Outputs the motor speed in a -10 V to +10 V (-200% to +200%) range.

Yaskawa recommends that you monitor the output frequency after SFS and the motor speed for delays in response and differences in reference values.

■ Adjust ASR Parameters

Use Table 12.37 to adjust ASR. The table lists parameters for motor 1. You can make the same changes to motor 2 parameters when you run a second motor.

Note:

When adjusting the proportional gain and integral time, adjust the proportional gain first.

Table 12.37 ASR Response and Possible Solutions

Problem		Possible Solutions
Speed response is slow.		<ul style="list-style-type: none"> • Increase C5-01/C5-03 [ASR Proportional Gain]. • Decrease C5-02/C5-04 [ASR Integral Time].
Overshoot or undershoot occurs at the end of acceleration or deceleration.		<ul style="list-style-type: none"> • Decrease C5-01/C5-03. • Increase C5-02/C5-04.
Vibration and oscillation occur at constant speed.		<ul style="list-style-type: none"> • Decrease C5-01/C5-03. • Increase C5-02/C5-04. • Increase C5-06 [ASR Delay Time].
Speed accuracy is unsatisfactory when you operate a motor that has a large quantity of rated slip in Closed Loop V/f Control.		<ul style="list-style-type: none"> • Examine the pulse number set to F1-01 [Encoder 1 Pulse Count (PPR)] and the gear ratio to F1-12 [Encoder 1 Gear Teeth 1] and F1-13 [Encoder 1 Gear Teeth 2]. • Make sure that you correctly set the pulse signal from the encoder. • Examine U6-04 [ASR Output] to make sure that the ASR operates at its output limit set to C5-05 [ASR Limit]. If the ASR is at the output limit, increase C5-05.

Problem		Possible Solutions
When $C5-12 = 1$ or $C5-32 = 1$ [Enabled] in Closed Loop V/f Control, over/undershoot occurs if you change speeds.	-	<ul style="list-style-type: none"> Decrease $C5-01/C5-03$. Increase $C5-02/C5-04$. Decrease the value set to $C5-05$.
<p>Oscillation at low speed and response is too slow at high speed.</p> <p>Oscillation at high speed and response is too slow at low speed.</p>	-	<ul style="list-style-type: none"> Closed Loop V/f Control Mode: Use $C5-03$ and $C5-04$ at maximum speed and $C5-01$ and $C5-02$ at minimum speed to set different ASR settings. Closed Loop Vector Control, PM Advanced Open Loop Vector Control, and PM Closed Loop Vector Control: Use $C5-01$ to $C5-04$ to set the best ASR settings for high and low speed. Use $C5-07$ [ASR Gain Switchover Frequency] to switch the ASR proportional gain and ASR integral time as specified by the output frequency.

■ C5-01: ASR Proportional Gain 1

No. (Hex.)	Name	Description	Default (Range)
C5-01 (021B) RUN	ASR Proportional Gain 1	<div style="display: flex; justify-content: space-between; align-items: center;"> V/f CL-V/f OLV CLV AOLV OLV/PM AOLV/PM CLV/PM EZOLV </div> Sets the gain to adjust ASR response.	Determined by A1-02 (0.00 - 300.00)

A higher gain gives a higher speed response. Usually, the gain increases with larger loads. Too much gain will cause vibration.

Note:

- The drive usually sets Motor 1 ASR with $C5-01$ and $C5-02$ [ASR Integral Time 1]. When you set $H1-xx = 77$ [MFDI Function Select = ASR Gain Switch], you can switch between $C5-01$ and $C5-03$ [ASR Proportional Gain 2]. You can also use $C5-01$ as an alternative to $C5-03$ and $C5-02$ as an alternative to $C5-04$ when the speed is less than or equal to the frequency set in $C5-07$ [ASR Gain Switchover Frequency].
- The drive automatically adjusts $C5-01$ in ASR Tuning.

■ C5-02: ASR Integral Time 1

No. (Hex.)	Name	Description	Default (Range)
C5-02 (021C) RUN	ASR Integral Time 1	<div style="display: flex; justify-content: space-between; align-items: center;"> V/f CL-V/f OLV CLV AOLV OLV/PM AOLV/PM CLV/PM EZOLV </div> Sets the ASR integral time.	Determined by A1-02 (0.000 - 60.000 s)

When you increase the integral time, the responsiveness will decrease. An integral time that is too short can cause oscillation.

■ C5-03: ASR Proportional Gain 2

No. (Hex.)	Name	Description	Default (Range)
C5-03 (021D) RUN	ASR Proportional Gain 2	<div style="display: flex; justify-content: space-between; align-items: center;"> V/f CL-V/f OLV CLV AOLV OLV/PM AOLV/PM CLV/PM EZOLV </div> Sets the gain to adjust ASR response.	Determined by A1-02 (0.00 - 300.00)

A higher gain provides a higher speed response. Usually, the gain increases with larger loads. Too much gain will cause vibration.

■ C5-04: ASR Integral Time 2

No. (Hex.)	Name	Description	Default (Range)
C5-04 (021E) RUN	ASR Integral Time 2	<div style="display: flex; justify-content: space-between; align-items: center;"> V/f CL-V/f OLV CLV AOLV OLV/PM AOLV/PM CLV/PM EZOLV </div> Sets the ASR integral time.	Determined by A1-02 (0.000 - 60.000 s)

When you increase the integral time, the responsiveness will decrease. An integral time that is too short can cause oscillation.

■ C5-05: ASR Limit

No. (Hex.)	Name	Description	Default (Range)
C5-05 (021F)	ASR Limit	<div style="display: flex; justify-content: space-between; align-items: center;"> V/f CL-V/f OLV CLV AOLV OLV/PM AOLV/PM CLV/PM EZOLV </div> Set the ASR output limit as a percentage of E1-04 [Maximum Output Frequency].	5.0% (0.0 - 20.0%)

If the motor rated slip is high, it is necessary to increase the setting for correct motor speed control. Use U6-04 [ASR Output] to make sure that ASR is operating at the limit set in this parameter. When ASR is operating at the limit, correctly set the PG signal and these parameters before you make changes to C5-05.

- F1-01 [Encoder 1 Pulse Count (PPR)]
- F1-12 [Encoder 1 Gear Teeth 1]
- F1-13 [Encoder 1 Gear Teeth 2]

■ C5-06: ASR Delay Time

No. (Hex.)	Name	Description	Default (Range)
C5-06 (0220)	ASR Delay Time	<div style="display: flex; justify-content: space-between; align-items: center;"> V/f CL-V/f OLV CLV AOLV OLV/PM AOLV/PM CLV/PM EZOLV </div> Sets the filter time constant of the torque reference output from the speed loop. Usually it is not necessary to change this setting.	Determined by A1-02 (0.000 - 0.500 s)

If you have a load with low rigidity or if oscillation is a problem, decrease C5-01 in 2-unit decrements or decrease C5-06 in 0.001-unit decrements.

■ C5-07: ASR Gain Switchover Frequency

No. (Hex.)	Name	Description	Default (Range)
C5-07 (0221)	ASR Gain Switchover Frequency	<div style="display: flex; justify-content: space-between; align-items: center;"> V/f CL-V/f OLV CLV AOLV OLV/PM AOLV/PM CLV/PM EZOLV </div> Sets the frequency where the drive will switch between these parameters: C5-01 and C5-03 [ASR Proportional Gain 1/2] C5-02 and C5-04 [ASR Integral Time 1/2]	Determined by A1-02 (Determined by A1-02)

Switching the proportional gain and integral time in the low or high speed range can help operation become stable. A good switching point is 80% of the frequency where oscillation occurs or at 80% of the maximum output frequency.

Note:

An MFDI set for H1-xx = 77 [MFDI Function Selection = ASR Gain (C5-03) Select] will have priority over the ASR gain switching frequency.

■ C5-08: ASR Integral Limit

No. (Hex.)	Name	Description	Default (Range)
C5-08 (0222)	ASR Integral Limit	<div style="display: flex; justify-content: space-between; align-items: center;"> V/f CL-V/f OLV CLV AOLV OLV/PM AOLV/PM CLV/PM EZOLV </div> Set the upper limit of the ASR integral amount as a percentage of the rated load.	400% (0 - 400%)

■ C5-12: Integral Operation @ Accel/Decel

No. (Hex.)	Name	Description	Default (Range)
C5-12 (0386)	Integral Operation @ Accel/Decel	<div style="display: flex; justify-content: space-between; align-items: center;"> V/f CL-V/f OLV CLV AOLV OLV/PM AOLV/PM CLV/PM EZOLV </div> Sets ASR integral operation during acceleration and deceleration.	0 (0, 1)

When it is necessary for the motor speed to be as near the frequency reference as possible during acceleration or deceleration, set this parameter to 1.

Note:

If you enable integral control, overshoot or undershoot can occur when acceleration or deceleration complete. If there are problems with overshooting and undershooting, set this parameter to 0.

0 : Disabled

Integral operation is always enabled during constant speed. The drive will not enable integral operation during acceleration or deceleration.

1 : Enabled

Integral operation is always enabled.

■ C5-17: Motor Inertia

No. (Hex.)	Name	Description	Default (Range)
C5-17 (0276) Expert	Motor Inertia	<div style="display: flex; justify-content: space-between; font-size: 0.8em;"> V/f CL-V/f OLV CLV AOLV OLV/PM AOLV/PM CLV/PM EZOLV </div> Sets the motor inertia.	Determined by α 2-04, C6-01, and E5-01 (0.0001 - 600.00 kgm ²)

Note:

The display units for the default setting and setting range are different for different models:

- 0.0001 kgm² units (setting range: 0.0001 kgm² to 6.0000 kgm²): 2004 to 2021, 4002 to 4012
- 0.001 kgm² units (setting range: 0.001 kgm² to 60.000 kgm²): 2030 to 2211, 4018 to 4103
- 0.01 kgm² units (setting range: 0.01 kgm² to 600.00 kgm²): 2257 to 2415, 4140 to 4H12

When $A1-02 = 3$ or 7 [Control Method Selection = CLV or CLV/PM], the drive automatically sets C5-17 to the value of "Motor Inertia" when you do Inertia Tuning or ASR Tuning.

■ C5-18: Load Inertia Ratio

No. (Hex.)	Name	Description	Default (Range)
C5-18 (0277) Expert	Load Inertia Ratio	<div style="display: flex; justify-content: space-between; font-size: 0.8em;"> V/f CL-V/f OLV CLV AOLV OLV/PM AOLV/PM CLV/PM EZOLV </div> Sets the load inertia ratio for the motor inertia.	1.0 (0.0 - 6000.0)

When $A1-02 = 3$ or 7 [Control Method Selection = CLV or CLV/PM], the drive automatically sets C5-18 to the load inertia ratio when you do Inertia Tuning or ASR Tuning.

■ C5-21: Motor 2 ASR Proportional Gain 1

No. (Hex.)	Name	Description	Default (Range)
C5-21 (0356) RUN	Motor 2 ASR Proportional Gain 1	<div style="display: flex; justify-content: space-between; font-size: 0.8em;"> V/f CL-V/f OLV CLV AOLV OLV/PM AOLV/PM CLV/PM EZOLV </div> Sets the gain to adjust ASR response for motor 2.	Determined by E3-01 (0.00 - 300.00)

A higher gain provides a higher speed response. Usually, the gain increases with larger loads. Too much gain will cause vibration.

Note:

- The drive usually sets Motor 2 ASR with C5-21 and C5-22 [Motor 2 ASR Integral Time 1]. You can also use C5-23 [Motor 2 ASR Proportional Gain 2] instead of C5-21 when the speed is less than or equal to the frequency set in C5-27 [Motor 2 ASR Gain Switchover Freq]. You can switch between C5-21 and C5-23 by setting $H1-xx = 77$ [MFD1 Function Selection = ASR Gain (C5-03) Select].
- The drive automatically adjusts C5-21 in ASR Tuning.

■ C5-22: Motor 2 ASR Integral Time 1

No. (Hex.)	Name	Description	Default (Range)
C5-22 (0357) RUN	Motor 2 ASR Integral Time 1	<div style="display: flex; justify-content: space-between; font-size: 0.8em;"> V/f CL-V/f OLV CLV AOLV OLV/PM AOLV/PM CLV/PM EZOLV </div> Sets the ASR integral time for motor 2.	Determined by E3-01 (0.000 - 60.000 s)

When you increase the integral time, the responsiveness will decrease. An integral time that is too short can cause oscillation.

Note:

The drive usually sets Motor 2 ASR with C5-21 [Motor 2 ASR Proportional Gain 1] and C5-22. You can also use C5-24 [Motor 2 ASR Integral Time 2] instead of C5-22 when the speed is less than or equal to the frequency set in C5-27 [Motor 2 ASR Gain Switchover Freq].

■ C5-23: Motor 2 ASR Proportional Gain 2

No. (Hex.)	Name	Description	Default (Range)
C5-23 (0358) RUN	Motor 2 ASR Proportional Gain 2	<div style="display: flex; justify-content: space-between; font-size: 0.8em;"> V/f CL-V/f OLV CLV AOLV OLV/PM AOLV/PM CLV/PM EZOLV </div> Sets the gain to adjust ASR response for motor 2.	Determined by E3-01 (0.00 - 300.00)

A higher gain provides a higher speed response. Usually, the gain increases with larger loads. Too much gain causes vibration.

■ **C5-24: Motor 2 ASR Integral Time 2**

No. (Hex.)	Name	Description	Default (Range)
C5-24 (0359) RUN	Motor 2 ASR Integral Time 2	<div style="display: flex; justify-content: space-between; font-size: 0.8em;"> V/f CL-V/f OLV CLV AOLV OLV/PM AOLV/PM CLV/PM EZOLV </div> Sets the ASR integral time for motor 2.	Determined by E3-01 (0.000 - 60.000 s)

When you increase the integral time, the responsiveness will decrease. An integral time that is too short can cause oscillation.

Note:

The drive usually sets Motor 2 ASR with C5-21 [Motor 2 ASR Proportional Gain 1] and C5-22 [Motor 2 ASR Integral Time 1]. You can also use C5-24 [Motor 2 ASR Integral Time 2] instead of C5-22 when the speed is less than or equal to the frequency set in C5-27 [Motor 2 ASR Gain Switchover Freq].

■ **C5-25: Motor 2 ASR Limit**

No. (Hex.)	Name	Description	Default (Range)
C5-25 (035A)	Motor 2 ASR Limit	<div style="display: flex; justify-content: space-between; font-size: 0.8em;"> V/f CL-V/f OLV CLV AOLV OLV/PM AOLV/PM CLV/PM EZOLV </div> Set the motor 2 ASR output limit as a percentage of E1-04 [Maximum Output Frequency].	5.0% (0.0 - 20.0%)

If the motor rated slip is high, it is necessary to increase the setting for correct motor speed control. Use U6-04 [ASR Output] to make sure that ASR is operating at the limit set in this parameter. When ASR is operating at the limit, correctly set the PG signal and these parameters before you make changes to C5-25.

- F1-31 [Encoder 2 Pulse Count (PPR)]
- F1-33 [Encoder 2 Gear Teeth 1]
- F1-34 [Encoder 2 Gear Teeth 2]

■ **C5-26: Motor 2 ASR Delay Time**

No. (Hex.)	Name	Description	Default (Range)
C5-26 (035B)	Motor 2 ASR Delay Time	<div style="display: flex; justify-content: space-between; font-size: 0.8em;"> V/f CL-V/f OLV CLV AOLV OLV/PM AOLV/PM CLV/PM EZOLV </div> Sets the motor 2 filter time constant of the torque reference output from the speed loop. Usually it is not necessary to change this setting.	Determined by E3-01 (0.000 - 0.500 s)

If you have a load with low rigidity or if oscillation is a problem, decrease C5-21 in 2-unit decrements or decrease C5-26 in 0.001-unit decrements.

■ **C5-27: Motor 2 ASR Gain Switchover Freq**

No. (Hex.)	Name	Description	Default (Range)
C5-27 (035C)	Motor 2 ASR Gain Switchover Freq	<div style="display: flex; justify-content: space-between; font-size: 0.8em;"> V/f CL-V/f OLV CLV AOLV OLV/PM AOLV/PM CLV/PM EZOLV </div> Sets the frequency where the drive will switch between these parameters: C5-21 and C5-23 [Motor 2 ASR Proportional Gain 1/2] C5-22 and C5-24 [Motor 2 ASR Integral Time 1/2]	0.0 (0.0 - 400.0)

Switching the proportional gain and integral time in the low or high speed range can help operation become stable. A good switching point is 80% of the frequency where oscillation occurs or at 80% of the maximum output frequency.

Note:

An MFDDI set for H1-xx = 77 [MFDDI Function Selection = ASR Gain (C5-03) Select] will have priority over the ASR gain switching frequency.

■ **C5-28: Motor 2 ASR Integral Limit**

No. (Hex.)	Name	Description	Default (Range)
C5-28 (035D)	Motor 2 ASR Integral Limit	<div style="display: flex; justify-content: space-between; font-size: 0.8em;"> V/f CL-V/f OLV CLV AOLV OLV/PM AOLV/PM CLV/PM EZOLV </div> Set the upper limit of the motor 2 ASR integral amount as a percentage of the rated load.	400% (0 - 400%)

■ C5-29: Speed Control Response

No. (Hex.)	Name	Description	Default (Range)
C5-29 (0B18) Expert	Speed Control Response	<input type="checkbox"/> V/f <input checked="" type="checkbox"/> CL-V/f <input type="checkbox"/> OLV <input type="checkbox"/> CLV <input type="checkbox"/> AOLV <input type="checkbox"/> OLV/PM <input type="checkbox"/> AOLV/PM <input type="checkbox"/> CLV/PM <input type="checkbox"/> EZOLV Sets the level of speed control responsiveness. Usually it is not necessary to change this setting.	0 (0, 1)

If a high level of speed control responsiveness is necessary, set $C5-29 = 1$, then adjust the speed control (ASR) parameter.

0 : Standard

1 : High Performance 1

■ C5-32: Motor 2 Integral Oper at Acc/Dec

No. (Hex.)	Name	Description	Default (Range)
C5-32 (0361)	Motor 2 Integral Oper at Acc/Dec	<input type="checkbox"/> V/f <input checked="" type="checkbox"/> CL-V/f <input type="checkbox"/> OLV <input type="checkbox"/> CLV <input type="checkbox"/> AOLV <input type="checkbox"/> OLV/PM <input type="checkbox"/> AOLV/PM <input type="checkbox"/> CLV/PM <input type="checkbox"/> EZOLV Sets ASR integral operation during acceleration and deceleration for motor 2.	0 (0, 1)

When it is necessary for the motor speed to be as near the frequency reference as possible during acceleration or deceleration, set this parameter to 1 .

Note:

If you enable integral control, overshoot or undershoot can occur when acceleration or deceleration complete. If there are problems with overshooting and undershooting, set this parameter to 0 .

0 : Disabled

Integral operation is not enabled during acceleration or deceleration. Integral operation is always enabled during constant speed.

1 : Enabled

Integral operation is always enabled.

■ C5-37: Motor 2 Inertia

No. (Hex.)	Name	Description	Default (Range)
C5-37 (0278) Expert	Motor 2 Inertia	<input type="checkbox"/> V/f <input type="checkbox"/> CL-V/f <input type="checkbox"/> OLV <input checked="" type="checkbox"/> CLV <input type="checkbox"/> AOLV <input type="checkbox"/> OLV/PM <input type="checkbox"/> AOLV/PM <input type="checkbox"/> CLV/PM <input type="checkbox"/> EZOLV Sets the motor inertia for motor 2.	Determined by o2-04, C6-01 (0.0001 - 600.00 kgm ²)

Note:

The display units for the default setting and setting range are different for different models:

- 0.0001 kgm² units (setting range: 0.0001 kgm² to 6.0000 kgm²): 2004 to 2021, 4002 to 4012
- 0.001 kgm² units (setting range: 0.001 kgm² to 60.000 kgm²): 2030 to 2211, 4018 to 4103
- 0.01 kgm² units (setting range: 0.01 kgm² to 600.00 kgm²): 2257 to 2415, 4140 to 4H12

The drive automatically sets $C5-37$ to the value of "Motor Inertia" when you do Inertia Tuning or ASR Tuning.

■ C5-38: Motor 2 Load Inertia Ratio

No. (Hex.)	Name	Description	Default (Range)
C5-38 (0279) Expert	Motor 2 Load Inertia Ratio	<input type="checkbox"/> V/f <input type="checkbox"/> CL-V/f <input type="checkbox"/> OLV <input checked="" type="checkbox"/> CLV <input type="checkbox"/> AOLV <input type="checkbox"/> OLV/PM <input type="checkbox"/> AOLV/PM <input type="checkbox"/> CLV/PM <input type="checkbox"/> EZOLV Sets the load inertia ratio for the motor 2 inertia.	1.0 (0.0 - 6000.0)

The drive automatically sets $C5-38$ to the value of [Load Inertia Ratio] when you do Inertia Tuning or ASR Tuning.

■ C5-39: ASR Primary Delay Time Const 2

No. (Hex.)	Name	Description	Default (Range)
C5-39 (030D)	ASR Primary Delay Time Const 2	<input type="checkbox"/> V/f <input type="checkbox"/> CL-V/f <input type="checkbox"/> OLV <input type="checkbox"/> CLV <input type="checkbox"/> AOLV <input type="checkbox"/> OLV/PM <input type="checkbox"/> AOLV/PM <input type="checkbox"/> CLV/PM <input type="checkbox"/> EZOLV Sets the filter time constant used when the torque reference is output from ASR. Usually it is not necessary to change this parameter.	0.000 s (0.000 - 0.500 s)

If you have a load with low rigidity or if oscillation is a problem, increase this setting in 0.01 unit increments.

■ **C5-50: Notch Filter Frequency**

No. (Hex.)	Name	Description	Default (Range)
C5-50 (0B14) Expert	Notch Filter Frequency	<div style="display: flex; justify-content: space-between; font-size: small;"> V/f CL-V/f OLV CLV AOLV OLV/PM AOLV/PM CLV/PM EZOLV </div> Sets the machine resonance frequency.	0 Hz (0, or 2 to 100 Hz)

Machine resonance can cause high-frequency noise and vibration during operation. A notch filter can help prevent the noise and vibration. Notch filters set the resonant frequency of the machine to remove specific vibrational frequency components caused by machine resonance.

Note:

- Correctly set the value for the notch filter frequency. If the frequency value is too low for the speed loop response frequency, the speed control function will not function correctly. Set the frequency to be a minimum of 4 times the speed loop response frequency.
- Set $C5-50 = 0$ [0 Hz] to disable the notch filter.

■ **C5-51: Notch Filter Bandwidth**

No. (Hex.)	Name	Description	Default (Range)
C5-51 (0B15) Expert	Notch Filter Bandwidth	<div style="display: flex; justify-content: space-between; font-size: small;"> V/f CL-V/f OLV CLV AOLV OLV/PM AOLV/PM CLV/PM EZOLV </div> Sets the notch width of the notch filter.	1.0 (0.5 - 5.0)

Note:

Set $C5-50 = 0$ [Notch Filter Frequency = 0 Hz] to disable the notch filter.

◆ **C6: Duty & Carrier Frequency**

C6 parameters are used to set the selection of drive duty rating, selection of carrier frequency, and upper and lower limits of carrier frequencies.

■ **C6-01: Normal / Heavy Duty Selection**

No. (Hex.)	Name	Description	Default (Range)
C6-01 (0223)	Normal / Heavy Duty Selection	<div style="display: flex; justify-content: space-between; font-size: small;"> V/f CL-V/f OLV CLV AOLV OLV/PM AOLV/PM CLV/PM EZOLV </div> Sets the drive duty rating.	0 (0, 1)

0 : Heavy Duty Rating

The overload tolerance is 150% of the rated output current for 60 seconds.

1 : Normal Duty Rating

The overload tolerance is 110% of the rated output current for 60 seconds.

There are two types of load ratings for this product depending on the load characteristics of the application: Heavy Duty Rating (HD) and Normal Duty Rating (ND).

The drive rated output current, overload tolerance, and acceleration stall prevention level change when the duty rating changes. Set the drive to agree with the duty rating of the selected drive capacity. In HD, the tolerance is 150% overload for 60 seconds. In ND, the tolerance is 110% overload for 60 seconds. The rated output current for ND drives is higher than the rated output current for HD drives. Refer to “Model-Specific Specifications“ for more information about the rated output current.

Note:

Duty rating changes when $E1-01$ [Input AC Supply Voltage] changes. When $E1-01 < 460 V$, the duty rating is HD1 or ND1. When $E1-01 \geq 460 V$, the duty rating is HD2 or ND2. When $E1-01 \geq 460 V$, the load characteristic level automatically changes from HD1 to HD2 or from ND1 to ND2.

Table 12.38 Differences between Heavy Duty Rating and Normal Duty Rating

Item	Heavy Duty Rating 1 (HD1)	Heavy Duty Rating 2 (HD2)	Normal Duty Rating 1 (ND1)	Normal Duty Rating 2 (ND2)
E1-01 Setting	200 V ≤ E1-01 ≤ 240 V 380 V ≤ E1-01 < 460 V	460 V ≤ E1-01 < 480 V	200 V ≤ E1-01 ≤ 240 V 380 V ≤ E1-01 < 460 V	460 V ≤ E1-01 < 480 V
C6-01 Setting	0		1	

Item	Heavy Duty Rating 1 (HD1)	Heavy Duty Rating 2 (HD2)	Normal Duty Rating 1 (ND1)	Normal Duty Rating 2 (ND2)
Load Characteristics				
Application	A high overload tolerance is necessary during start up, acceleration, deceleration, and equivalent conditions. <ul style="list-style-type: none"> • Extruder • Conveyor • Cranes and hoists • Constant torque or high overload capacity are necessary. 		Overload tolerance is not necessary. <ul style="list-style-type: none"> • Fan • Pump • Blower 	
Overload Tolerance	150% - 60 seconds		110% - 60 seconds	
Stall Prevent Level during Accel	150%		110%	
Stall Prevent Level during Run	150%		110%	
Carrier Frequency	2 kHz		2 kHz Swing-PWM	

Note:

- Set the stall prevention level during acceleration with *L3-02* and the stall prevention level during run with *L3-06*.
- Changing *C6-01* also changes the maximum capacity of applicable drive motors. The drive automatically changes the setting values *E2-xx* and *E4-xx* to applicable values. The drive also automatically changes these parameters that depend on motor output:
 - b8-04 [Energy Saving Coefficient Value]
 - C5-17 [Motor Inertia]
 - C5-37 [Motor 2 Inertia]
 - L2-03 [Minimum Baseblock Time]
 - L3-24 [Motor Accel Time @ Rated Torque]
 - n5-02 [Motor Inertia Acceleration Time]

■ C6-02: Carrier Frequency Selection

No. (Hex.)	Name	Description	Default (Range)
C6-02 (0224)	Carrier Frequency Selection	V/f CL-V/f OLV CLV AOLV OL/PM AOLV/PM CLV/PM EZOLV Sets the carrier frequency for the transistors in the drive.	Determined by A1-02, C6-01, and o2-04 (Determined by A1-02)

Changes to the switching frequency will decrease audible noise and decrease leakage current.

Note:

Increasing the carrier frequency to more than the default setting will automatically decrease the drive current rating.

1 : 2.0 kHz

2 : 5.0 kHz (4.0 kHz for AOLV/PM)

3 : 8.0 kHz (6.0 kHz for AOLV/PM)

4 : 10.0 kHz (8.0 kHz for AOLV/PM)

5 : 12.5 kHz (10.0 kHz for AOLV/PM)

6 : 15.0 kHz (12.0 kHz for AOLV/PM)

7 : Swing PWM4 (Audible Sound 1)

8 : Swing PWM4 (Audible Sound 2)

9 : Swing PWM4 (Audible Sound 3)

A : Swing PWM4 (Audible Sound 4)

F : User Defined (C6-03 to C6-05)

Use *C6-03* to *C6-05* to set detailed setting values.

Note:

- The carrier frequency for Swing PWM 1 to 4 is equivalent to 2.0 kHz. Swing PWM applies a special PWM pattern to decrease the audible noise.
- The setting range changes when the *A1-02 [Control Method Selection]* value changes:
 - 3, 5, 7, 8 [*CLV, OLV/PM, CLV/PM, EZOLV*]: You cannot set to 7 to A.
 - 4 [*AOLV*]: You cannot set to 6, 7 to A, or F.
 - 6 [*AOLV/PM*]: You cannot set to 7 to A, or F.

Table 12.39 Guidelines for Carrier Frequency Parameter Setup

Symptom	Remedy
Speed and torque are not stable at low speed.	Decrease the carrier frequency.
Speed and torque are not stable at low speed.	Decrease the carrier frequency.
Too much leakage current from the drive.	Decrease the carrier frequency.
Wiring between the drive and motor is too long.	Decrease the carrier frequency. Note: If the motor cable is too long, it can be necessary to decrease the carrier frequency. Refer to Table 12.40 for the wiring distance and decrease the carrier frequency.
Audible motor noise is too loud.	Increase the carrier frequency. Use Swing PWM. Note: The default carrier frequency in ND is Swing PWM 1 (<i>C6-02 = 7</i>), with a 2 kHz base. You can increase the carrier frequency in Normal Duty mode, but this will decrease the drive rated current.

Table 12.40 Wiring Distance

Wiring Distance	Up to 50 m	Up to 100 m	Greater than 100 m
C6-02 [Carrier Frequency Selection]	1 to F (up to 15 kHz)	1 to 2 (up to 5 kHz), 7	1 (up to 2 kHz), 7

Note:

When *A1-02 = 5 or 6 [Control Method Selection = OLV/PM or AOLV/PM]*, the maximum cable length is 100 m (328 ft).

■ **C6-03: Carrier Frequency Upper Limit**

No. (Hex.)	Name	Description	Default (Range)
C6-03 (0225)	Carrier Frequency Upper Limit	V/f CL-V/f OLV CLV AOLV OLV/PM AOLV/PM CLV/PM EZOLV Sets the upper limit of the carrier frequency. Set <i>C6-02 = F [Carrier Frequency Selection = User Defined (C6-03 to C6-05)]</i> to set this parameter.	Determined by C6-02 (1.0 - 15.0 kHz)

Setting a Fixed User-Defined Carrier Frequency

When you cannot use *C6-02* to set a carrier frequency between set selectable values, you can set the value in *C6-03*. The carrier frequency will be fixed to the value set to *C6-03*.

When *A1-02 = 0, 1 [Control Method Selection = V/f, CL-V/f]*, set *C6-03 = C6-04 [Carrier Frequency Lower Limit]* to fix the carrier frequency.

Setting a Variable Carrier Frequency to Agree with the Output Frequency

When *A1-02 = 0, 1*, set *C6-03, C6-04*, and *C6-05 [Carrier Freq Proportional Gain]* as shown in [Figure 12.59](#) to make the carrier frequency change linearly with the output frequency.

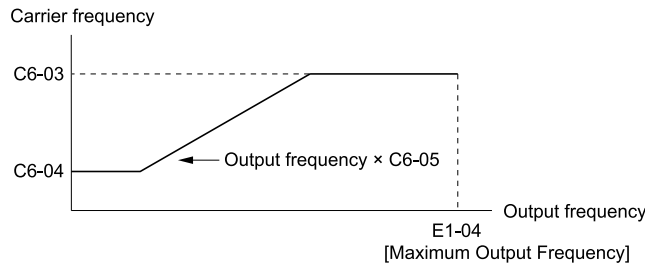

Figure 12.59 Setting a Variable Carrier Frequency to Agree with the Output Frequency

Note:

- When $C6-05 \leq 7$, the drive disables $C6-04$. The carrier frequency is fixed to the value set to $C6-03$.
- The drive detects *oPE11 [Carrier Frequency Setting Error]* when these conditions are correct at the same time:
 - $C6-05 \geq 6$
 - $C6-04 \geq C6-03$
- When $A1-02 = 0, 2, 5, 8$ [*Control Method Selection = v/f, OLV, OLV/PM, EZOLV*], in the area where the output frequency is more than $C6-03$ and $C6-12$, the carrier frequency = output frequency $\times 12$, and it will change with the output frequency.

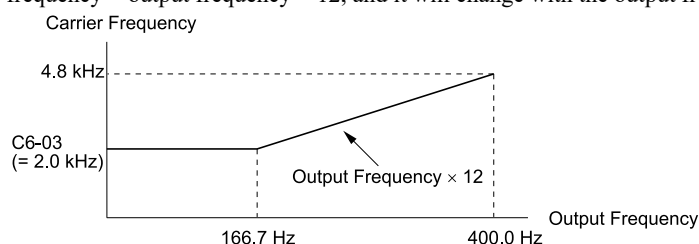

Figure 12.60 Carrier Frequency when $C6-03 = 2.0$ kHz, $E1-04 = 400.0$ Hz

■ C6-04: Carrier Frequency Lower Limit

No. (Hex.)	Name	Description	Default (Range)
C6-04 (0226)	Carrier Frequency Lower Limit	<div style="display: flex; justify-content: space-between; font-size: small;"> <input checked="" type="checkbox"/> V/f <input checked="" type="checkbox"/> CL-V/f <input type="checkbox"/> OLV <input type="checkbox"/> CLV <input type="checkbox"/> AOLV <input type="checkbox"/> OLV/PM <input type="checkbox"/> AOLV/PM <input type="checkbox"/> CLV/PM <input type="checkbox"/> EZOLV </div> Sets the lower limit of the carrier frequency. Set $C6-02 = F$ [<i>Carrier Frequency Selection = User Defined (C6-03 to C6-05)</i>] to set this parameter.	Determined by $C6-02$ (1.0 - 15.0 kHz)

Set $C6-03$ [*Carrier Frequency Upper Limit*], $C6-04$, and $C6-05$ [*Carrier Freq Proportional Gain*] to make the carrier frequency change linearly with the output frequency.

Note:

- The drive detects *oPE11 [Carrier Frequency Setting Error]* when these conditions are correct at the same time:
- $C6-04 \geq C6-03$
 - $C6-05 \geq 6$

■ C6-05: Carrier Freq Proportional Gain

No. (Hex.)	Name	Description	Default (Range)
C6-05 (0227)	Carrier Freq Proportional Gain	<div style="display: flex; justify-content: space-between; font-size: small;"> <input checked="" type="checkbox"/> V/f <input checked="" type="checkbox"/> CL-V/f <input type="checkbox"/> OLV <input type="checkbox"/> CLV <input type="checkbox"/> AOLV <input type="checkbox"/> OLV/PM <input type="checkbox"/> AOLV/PM <input type="checkbox"/> CLV/PM <input type="checkbox"/> EZOLV </div> Sets the proportional gain for the carrier frequency. Set $C6-02 = F$ [<i>Carrier Frequency Selection = User Defined (C6-03 to C6-05)</i>] to set this parameter.	Determined by $C6-02$ (0 - 99)

Set $C6-03$ [*Carrier Frequency Upper Limit*], $C6-04$ [*Carrier Frequency Lower Limit*], and $C6-05$ to make the carrier frequency change linearly with the output frequency.

■ C6-09: Carrier Freq at Rotational Tune

No. (Hex.)	Name	Description	Default (Range)
C6-09 (022B)	Carrier Freq at Rotational Tune	<div style="display: flex; justify-content: space-between; font-size: small;"> <input type="checkbox"/> V/f <input type="checkbox"/> CL-V/f <input checked="" type="checkbox"/> OLV <input checked="" type="checkbox"/> CLV <input type="checkbox"/> AOLV <input type="checkbox"/> OLV/PM <input type="checkbox"/> AOLV/PM <input type="checkbox"/> CLV/PM <input type="checkbox"/> EZOLV </div> Sets the Auto-Tuning carrier frequency. Usually it is not necessary to change this setting.	0 (0, 1)

If you set $C6-09 = 0$ for a high-frequency or low-impedance motor, it can cause *oC [Overcurrent]*. To prevent *oC*, set the carrier frequency to a high value and set $C6-09 = 1$ before you do Auto-Tuning.

The procedure to set the carrier frequency when the $A1-02$ [*Control Method Selection*] setting changes.

- When $A1-02 = 2, 3$ [*OLV, CLV*], set $C6-02 = F$ [*Carrier Frequency Selection = User Defined (C6-03 to C6-05)*] and then increase the value set to $C6-03$ [*Carrier Frequency Upper Limit*].
- When $A1-02 = 4$ to 7 [*AOLV, OLV/PM, AOLV/PM, or CLV/PM*], use $C6-02$ to increase the carrier frequency.

0 : 5kHz

Note:

When $A1-02 = 5, 6, 7$ [*Control Method Selection = OLV/PM, AOLV/PM, CLV/PM*], the carrier frequency is 2 kHz.

1 : use C6-03

Note:

When $A1-02 = 5, 6, 7$ [*Control Method Selection = OLV/PM, AOLV/PM, CLV/PM*], the carrier frequency is as specified in $C6-02$.

12.5 d: References

d parameters [References] set the frequency reference input method and dead band range. They also set torque control, field weakening, and field forcing functions.

WARNING! Sudden Movement Hazard. Use fast stop circuits to safely and quickly stop the drive. After you wire the fast stop circuits, you must check their operation. Test the operation of the fast stop function before you use the drive. If you do not test the fast stop circuit before you operate the drive, it can cause serious injury or death.

WARNING! Sudden Movement Hazard. When you use the drive in a lifting application, you must also install external safety circuitry. The drive does not have protection against accidental load drops in lifting applications. Install electrical and/or mechanical safety circuit mechanisms that are isolated from the drive circuitry. If you do not use external safety circuitry, the drive could drop the load and cause serious injury or death.

◆ d1: Frequency Reference

Figure 12.61 shows the frequency reference input method, command source selection method and priority descriptions.

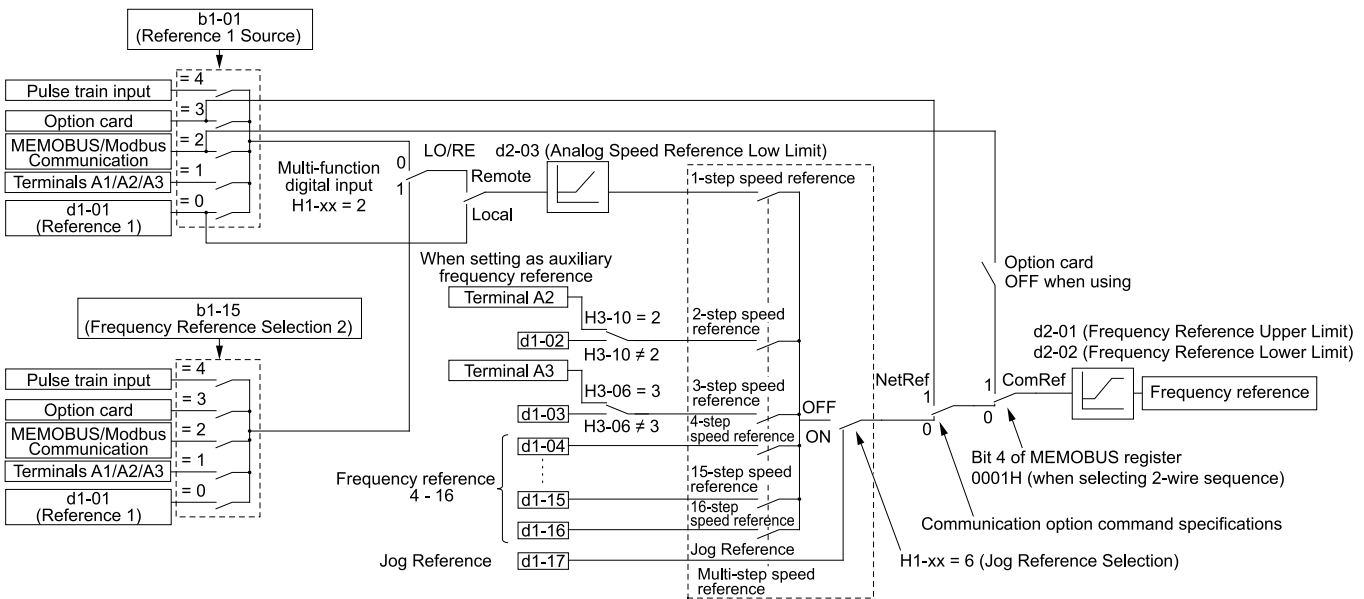

Figure 12.61 Frequency Reference Setting Hierarchy

■ Multi-Step Speed Operation

The drive has a multi-step speed operation function that can set many frequency references in advance. Set frequency references in *d1-xx* parameters. You can select the set frequency references with MFDI signals from an external source. Activate and deactivate the digital input to select the frequency reference to change the motor speed in steps. You can use the 16-step frequency reference and one Jog Frequency Reference (JOG command) to switch the speed to the maximum 17-step speeds.

Note:

- The Jog Frequency Reference (JOG command) overrides all other frequency references.
- You can use the MFDI to switch the frequency reference when the motor is running. The drive will apply the enabled acceleration and deceleration times.
- The default settings for Multi-Step Speed Reference 1 (master frequency reference) and Multi-Step Speed Reference 2 (auxiliary frequency reference) are the analog frequency reference. Also, voltage command input terminal A1 and current input terminal A2 for Multi-Step Speed Reference 1 (master frequency reference) are added internally by default. The drive uses Multi-Step Speed Reference 1 when the signal is connected to an analog input terminal.

■ Setting Procedures for Multi-step Speed Operation

Use an Analog Input as Reference 1 and 2

This section gives information about the procedures to set these examples:

- Multi-Step Speed 6 (6 types of frequency references)
- When you set the voltage input of analog inputs from terminals A1 and A3 to -10 V to +10 V

Procedure	Configuration Parameter	Task Contents
1	Reference 1	<ol style="list-style-type: none"> Set $b1-01 = 1$ [Frequency Reference Selection 1 = Analog Input]. Set $H3-02 = 0$ [Terminal A1 Function Selection = Frequency Reference]. Set $H3-01 = 1$ [Terminal A1 Signal Level Select = -10 to +10V (Bipolar Reference)].
2	Reference 2	<ol style="list-style-type: none"> Set $H3-06 = 2$ [Terminal A3 Function Selection = Auxiliary Frequency Reference 1]. Set $H3-05 = 1$ [Terminal A3 Signal Level Select = -10 to +10V (Bipolar Reference)].
3	Signal type of analog input	Set DIP switches S1-1 and S1-3 on the control circuit board to the V-side (voltage). Note: Set this before you energize the drive.
4	Reference 3	Set the value of $d1-03$ [Reference 3].
5	Reference 4	Set the value of $d1-04$ [Reference 4].
6	Reference 5	Set the value of $d1-05$ [Reference 5].
7	Jog Reference	Set $d1-17$ [Jog Reference] to the jog speed.
8	External digital input (3 inputs)	Set the Multi-Step Speed Reference 1 to 3 [$H1-xx = 3, 4, 5$] to one of the MFDI terminals S1 to S8.
9	JOG command	Set the Jog Reference Selection [$H1-xx = 6$] to one of the MFDI terminals S1 to S8.

Use the Maximum 17-Step Speed with All Digital Inputs

This section is the procedure to set the 17-step speeds (17 types of frequency references) without an analog input.

Procedure	Configuration Parameter	Task Contents
1	Reference 1	<ol style="list-style-type: none"> Set $b1-01 = 0$ [Frequency Reference Selection 1 = Keypad]. Set the value of $d1-01$ [Reference 1].
2	Reference 2	<ol style="list-style-type: none"> Set $H3-06 = F$ [Terminal A3 Function Selection = Not Used], and disables the analog reference. Set the value of $d1-02$ [Reference 2].
3	Reference 3	<ol style="list-style-type: none"> Set $H3-10 = F$ [Terminal A2 Function Selection = Not Used], and disables the analog reference. Set the value of $d1-03$ [Reference 3].
4	Reference 4	Set the value of $d1-04$ [Reference 4].
5	Reference 5 to 16	Sets the values of $d1-05$ to $d1-16$ [Reference 5 to 16].
6	Jog Reference	Set $d1-17$ [Jog Reference] to the jog speed.
7	External digital input (4 inputs)	Set Multi-Step Speed Reference 1 to 4 [$H1-xx = 3, 4, 5, 32$] to one of the MFDI terminals S1 to S8.
8	JOG command	Set the Jog Reference Selection [$H1-xx = 6$] to one of the MFDI terminals S1 to S8.

Multi-step Speed Operation Combinations

Refer to [Table 12.41](#) and [Figure 12.62](#) for information about multi-step speed reference combinations. The selected frequency reference changes when the combination of digital input signals from an external source changes.

Table 12.41 Multi-step Speed Reference and MFDI Terminal Combinations

Related Parameters	Multi-Step Speed Reference 1 $H1-xx = 3$	Multi-Step Speed Reference 2 $H1-xx = 4$	Multi-Step Speed Reference 3 $H1-xx = 5$	Multi-Step Speed Reference 4 $H1-xx = 32$	Jog Reference $H1-xx = 6$
Reference 1 (set in $b1-01$)	OFF	OFF	OFF	OFF	OFF
Reference 2 ($d1-02$ or terminals A1, A2, A3)	ON	OFF	OFF	OFF	OFF
Reference 3 ($d1-03$ or terminals A1, A2, A3)	OFF	ON	OFF	OFF	OFF
Reference 4 ($d1-04$)	ON	ON	OFF	OFF	OFF
Reference 5 ($d1-05$)	OFF	OFF	ON	OFF	OFF
Reference 6 ($d1-06$)	ON	OFF	ON	OFF	OFF
Reference 7 ($d1-07$)	OFF	ON	ON	OFF	OFF
Reference 8 ($d1-08$)	ON	ON	ON	OFF	OFF
Reference 9 ($d1-09$)	OFF	OFF	OFF	ON	OFF
Reference 10 ($d1-10$)	ON	OFF	OFF	ON	OFF
Reference 11 ($d1-11$)	OFF	ON	OFF	ON	OFF
Reference 12 ($d1-12$)	ON	ON	OFF	ON	OFF

Related Parameters	Multi-Step Speed Reference 1 H1-xx = 3	Multi-Step Speed Reference 2 H1-xx = 4	Multi-Step Speed Reference 3 H1-xx = 5	Multi-Step Speed Reference 4 H1-xx = 32	Jog Reference H1-xx = 6
Reference 13 (d1-13)	OFF	OFF	ON	ON	OFF
Reference 14 (d1-14)	ON	OFF	ON	ON	OFF
Reference 15 (d1-15)	OFF	ON	ON	ON	OFF
Reference 16 (d1-16)	ON	ON	ON	ON	OFF
Jog Reference (d1-17) *1	-	-	-	-	ON

*1 The Jog Frequency Reference (JOG command) overrides all other frequency references.

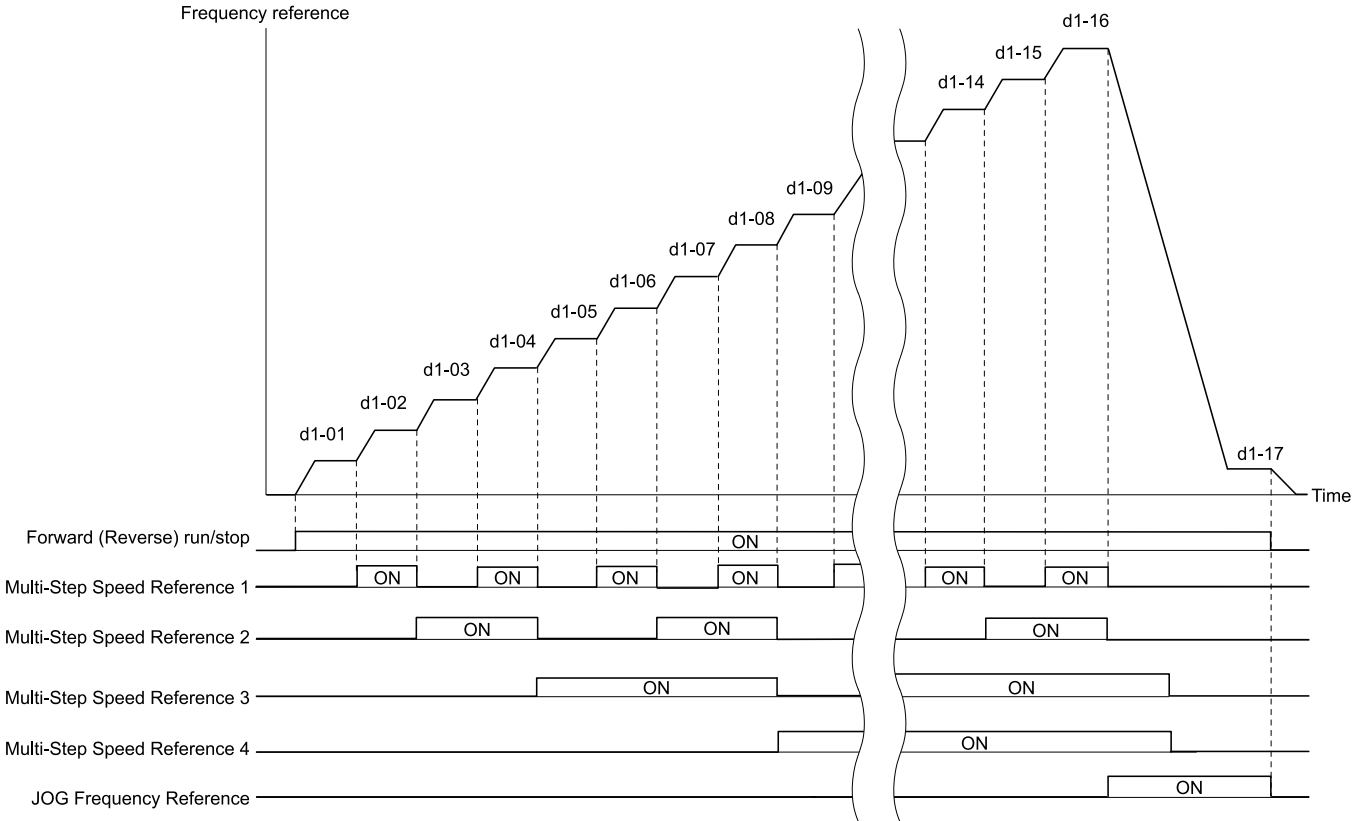

Figure 12.62 Time Chart for Multi-step Speed Reference/JOG Reference

■ d1-01: Reference 1

No. (Hex.)	Name	Description	Default (Range)
d1-01 (0280) RUN	Reference 1	V/f CL-V/f OLV CLV AOLV OLV/PM AOLV/PM CLV/PM EZOLV Sets the frequency reference in the units from o1-03 [Frequency Display Unit Selection].	0.00 Hz (0.00 - 590.00 Hz)

Note:

- The upper limit value changes when the E1-04 [Maximum Output Frequency] and d2-01 [Frequency Reference Upper Limit] values change. Calculate the upper limit value with this formula:
Upper limit value = (E1-04) × (d2-01) / 100
- When A1-02 = 6, 7 [Control Method Selection = AOLV/PM, CLV/PM], the drive changes o1-03 = 1 [0.01% (100% = E1-04)].
- To set d1-01 to 1-step speed parameter in a multi-step speed operation, set b1-01 = 0 [Frequency Reference Selection 1 = Keypad].

■ d1-02: Reference 2

No. (Hex.)	Name	Description	Default (Range)
d1-02 (0281) RUN	Reference 2	V/f CL-V/f OLV CLV AOLV OLV/PM AOLV/PM CLV/PM EZOLV Sets the frequency reference in the units from o1-03 [Frequency Display Unit Selection].	0.00 Hz (0.00 - 590.00 Hz)

Note:

- The upper limit value changes when the *E1-04 [Maximum Output Frequency]* and *d2-01 [Frequency Reference Upper Limit]* values change.
- When *A1-02 = 6, 7 [Control Method Selection = AOLV/PM, CLV/PM]*, the drive changes *o1-03 = 1 [0.01% (100% = E1-04)]*.
- To set *d1-02* to Multi-Step Speed 2, set *H3-02, H3-06, and H3-10 ≠ 2 [MFAI Function Select ≠ Auxiliary Frequency Reference 1]*. When the status is the default setting, set *H3-06 = F [Terminal A3 Function Selection = Not Used]*.

■ d1-03: Reference 3

No. (Hex.)	Name	Description	Default (Range)
d1-03 (0282) RUN	Reference 3	<div style="display: flex; justify-content: space-between; gap: 5px;"> V/f CL-V/f OLV CLV AOLV OLV/PM AOLV/PM CLV/PM EZOLV </div> Sets the frequency reference in the units from <i>o1-03 [Frequency Display Unit Selection]</i> .	0.00 Hz (0.00 - 590.00 Hz)

Note:

- The upper limit value changes when the *E1-04 [Maximum Output Frequency]* and *d2-01 [Frequency Reference Upper Limit]* values change.
- When *A1-02 = 6, 7 [Control Method Selection = AOLV/PM, CLV/PM]*, the drive changes *o1-03 = 1 [0.01% (100% = E1-04)]*.
- To set *d1-03* to Multi-Step Speed 3, set *H3-02, H3-06, and H3-10 ≠ 3 [MFAI Function Select ≠ Auxiliary Frequency Reference 2]*.

■ d1-04: Reference 4

No. (Hex.)	Name	Description	Default (Range)
d1-04 (0283) RUN	Reference 4	<div style="display: flex; justify-content: space-between; gap: 5px;"> V/f CL-V/f OLV CLV AOLV OLV/PM AOLV/PM CLV/PM EZOLV </div> Sets the frequency reference in the units from <i>o1-03 [Frequency Display Unit Selection]</i> .	0.00 Hz (0.00 - 590.00 Hz)

Note:

- The upper limit value changes when the *E1-04 [Maximum Output Frequency]* and *d2-01 [Frequency Reference Upper Limit]* values change.
- When *A1-02 = 6, 7 [Control Method Selection = AOLV/PM, CLV/PM]*, the drive changes *o1-03 = 1 [0.01% (100% = E1-04)]*.
- This parameter sets the frequency reference of Multi-Step Speed 4.

■ d1-05: Reference 5

No. (Hex.)	Name	Description	Default (Range)
d1-05 (0284) RUN	Reference 5	<div style="display: flex; justify-content: space-between; gap: 5px;"> V/f CL-V/f OLV CLV AOLV OLV/PM AOLV/PM CLV/PM EZOLV </div> Sets the frequency reference in the units from <i>o1-03 [Frequency Display Unit Selection]</i> .	0.00 Hz (0.00 - 590.00 Hz)

Note:

- The upper limit value changes when the *E1-04 [Maximum Output Frequency]* and *d2-01 [Frequency Reference Upper Limit]* values change.
- When *A1-02 = 6, 7 [Control Method Selection = AOLV/PM, CLV/PM]*, the drive changes *o1-03 = 1 [0.01% (100% = E1-04)]*.
- This parameter sets the frequency reference of Multi-Step Speed 5.

■ d1-06: Reference 6

No. (Hex.)	Name	Description	Default (Range)
d1-06 (0285) RUN	Reference 6	<div style="display: flex; justify-content: space-between; gap: 5px;"> V/f CL-V/f OLV CLV AOLV OLV/PM AOLV/PM CLV/PM EZOLV </div> Sets the frequency reference in the units from <i>o1-03 [Frequency Display Unit Selection]</i> .	0.00 Hz (0.00 - 590.00 Hz)

Note:

- The upper limit value changes when the *E1-04 [Maximum Output Frequency]* and *d2-01 [Frequency Reference Upper Limit]* values change.
- When *A1-02 = 6, 7 [Control Method Selection = AOLV/PM, CLV/PM]*, the drive changes *o1-03 = 1 [0.01% (100% = E1-04)]*.
- This parameter sets the frequency reference of Multi-Step Speed 6.

■ d1-07: Reference 7

No. (Hex.)	Name	Description	Default (Range)
d1-07 (0286) RUN	Reference 7	<div style="display: flex; justify-content: space-between; align-items: center;"> V/f CL-V/f OLV CLV AOLV OLV/PM AOLV/PM CLV/PM EZOLV </div> Sets the frequency reference in the units from o1-03 [Frequency Display Unit Selection].	0.00 Hz (0.00 - 590.00 Hz)

Note:

- The upper limit value changes when the E1-04 [Maximum Output Frequency] and d2-01 [Frequency Reference Upper Limit] values change.
- When A1-02 = 6, 7 [Control Method Selection = AOLV/PM, CLV/PM], the drive changes o1-03 = 1 [0.01% (100% = E1-04)].
- This parameter sets the frequency reference of Multi-Step Speed 7.

■ d1-08: Reference 8

No. (Hex.)	Name	Description	Default (Range)
d1-08 (0287) RUN	Reference 8	<div style="display: flex; justify-content: space-between; align-items: center;"> V/f CL-V/f OLV CLV AOLV OLV/PM AOLV/PM CLV/PM EZOLV </div> Sets the frequency reference in the units from o1-03 [Frequency Display Unit Selection].	0.00 Hz (0.00 - 590.00 Hz)

Note:

- The upper limit value changes when the E1-04 [Maximum Output Frequency] and d2-01 [Frequency Reference Upper Limit] values change.
- When A1-02 = 6, 7 [Control Method Selection = AOLV/PM, CLV/PM], the drive changes o1-03 = 1 [0.01% (100% = E1-04)].
- This parameter sets the frequency reference of Multi-Step Speed 8.

■ d1-09: Reference 9

No. (Hex.)	Name	Description	Default (Range)
d1-09 (0288) RUN	Reference 9	<div style="display: flex; justify-content: space-between; align-items: center;"> V/f CL-V/f OLV CLV AOLV OLV/PM AOLV/PM CLV/PM EZOLV </div> Sets the frequency reference in the units from o1-03 [Frequency Display Unit Selection].	0.00 Hz (0.00 - 590.00 Hz)

Note:

- The upper limit value changes when the E1-04 [Maximum Output Frequency] and d2-01 [Frequency Reference Upper Limit] values change.
- When A1-02 = 6, 7 [Control Method Selection = AOLV/PM, CLV/PM], the drive changes o1-03 = 1 [0.01% (100% = E1-04)].
- This parameter sets the frequency reference of Multi-Step Speed 9.

■ d1-10: Reference 10

No. (Hex.)	Name	Description	Default (Range)
d1-10 (028B) RUN	Reference 10	<div style="display: flex; justify-content: space-between; align-items: center;"> V/f CL-V/f OLV CLV AOLV OLV/PM AOLV/PM CLV/PM EZOLV </div> Sets the frequency reference in the units from o1-03 [Frequency Display Unit Selection].	0.00 Hz (0.00 - 590.00 Hz)

Note:

- The upper limit value changes when the E1-04 [Maximum Output Frequency] and d2-01 [Frequency Reference Upper Limit] values change.
- When A1-02 = 6, 7 [Control Method Selection = AOLV/PM, CLV/PM], the drive changes o1-03 = 1 [0.01% (100% = E1-04)].
- This parameter sets the frequency reference of Multi-Step Speed 10.

■ d1-11: Reference 11

No. (Hex.)	Name	Description	Default (Range)
d1-11 (028C) RUN	Reference 11	<div style="display: flex; justify-content: space-between; align-items: center;"> V/f CL-V/f OLV CLV AOLV OLV/PM AOLV/PM CLV/PM EZOLV </div> Sets the frequency reference in the units from o1-03 [Frequency Display Unit Selection].	0.00 Hz (0.00 - 590.00 Hz)

Note:

- The upper limit value changes when the E1-04 [Maximum Output Frequency] and d2-01 [Frequency Reference Upper Limit] values change.
- When A1-02 = 6, 7 [Control Method Selection = AOLV/PM, CLV/PM], the drive changes o1-03 = 1 [0.01% (100% = E1-04)].
- This parameter sets the frequency reference of Multi-Step Speed 11.

■ d1-12: Reference 12

No. (Hex.)	Name	Description	Default (Range)
d1-12 (028D) RUN	Reference 12	V/f CL-V/f OLV CLV AOLV OLV/PM AOLV/PM CLV/PM EZOLV Sets the frequency reference in the units from o1-03 [Frequency Display Unit Selection].	0.00 Hz (0.00 - 590.00 Hz)

Note:

- The upper limit value changes when the E1-04 [Maximum Output Frequency] and d2-01 [Frequency Reference Upper Limit] values change.
- When A1-02 = 6, 7 [Control Method Selection = AOLV/PM, CLV/PM], the drive changes o1-03 = 1 [0.01% (100% = E1-04)].
- This parameter sets the frequency reference of Multi-Step Speed 12.

■ d1-13: Reference 13

No. (Hex.)	Name	Description	Default (Range)
d1-13 (028E) RUN	Reference 13	V/f CL-V/f OLV CLV AOLV OLV/PM AOLV/PM CLV/PM EZOLV Sets the frequency reference in the units from o1-03 [Frequency Display Unit Selection].	0.00 Hz (0.00 - 590.00 Hz)

Note:

- The upper limit value changes when the E1-04 [Maximum Output Frequency] and d2-01 [Frequency Reference Upper Limit] values change.
- When A1-02 = 6, 7 [Control Method Selection = AOLV/PM, CLV/PM], the drive changes o1-03 = 1 [0.01% (100% = E1-04)].
- This parameter sets the frequency reference of Multi-Step Speed 13.

■ d1-14: Reference 14

No. (Hex.)	Name	Description	Default (Range)
d1-14 (028F) RUN	Reference 14	V/f CL-V/f OLV CLV AOLV OLV/PM AOLV/PM CLV/PM EZOLV Sets the frequency reference in the units from o1-03 [Frequency Display Unit Selection].	0.00 Hz (0.00 - 590.00 Hz)

Note:

- The upper limit value changes when the E1-04 [Maximum Output Frequency] and d2-01 [Frequency Reference Upper Limit] values change.
- When A1-02 = 6, 7 [Control Method Selection = AOLV/PM, CLV/PM], the drive changes o1-03 = 1 [0.01% (100% = E1-04)].
- This parameter sets the frequency reference of Multi-Step Speed 14.

■ d1-15: Reference 15

No. (Hex.)	Name	Description	Default (Range)
d1-15 (0290) RUN	Reference 15	V/f CL-V/f OLV CLV AOLV OLV/PM AOLV/PM CLV/PM EZOLV Sets the frequency reference in the units from o1-03 [Frequency Display Unit Selection].	0.00 Hz (0.00 - 590.00 Hz)

Note:

- The upper limit value changes when the E1-04 [Maximum Output Frequency] and d2-01 [Frequency Reference Upper Limit] values change.
- When A1-02 = 6, 7 [Control Method Selection = AOLV/PM, CLV/PM], the drive changes o1-03 = 1 [0.01% (100% = E1-04)].
- This parameter sets the frequency reference of Multi-Step Speed 15.

■ d1-16: Reference 16

No. (Hex.)	Name	Description	Default (Range)
d1-16 (0291) RUN	Reference 16	V/f CL-V/f OLV CLV AOLV OLV/PM AOLV/PM CLV/PM EZOLV Sets the frequency reference in the units from o1-03 [Frequency Display Unit Selection].	0.00 Hz (0.00 - 590.00 Hz)

Note:

- The upper limit value changes when the E1-04 [Maximum Output Frequency] and d2-01 [Frequency Reference Upper Limit] values change.
- When A1-02 = 6, 7 [Control Method Selection = AOLV/PM, CLV/PM], the drive changes o1-03 = 1 [0.01% (100% = E1-04)].
- This parameter sets the frequency reference of Multi-Step Speed 16.

■ **d1-17: Jog Reference**

No. (Hex.)	Name	Description	Default (Range)
d1-17 (0292) RUN	Jog Reference	V/f CL-V/f OLV CLV AOLV OLV/PM AOLV/PM CLV/PM EZOLV Sets the Jog frequency reference in the units from o1-03 [Frequency Display Unit Selection]. Set H1-xx = 6 [MFDI Function Select = Jog Reference Selection] to use the Jog frequency reference.	6.00 Hz (0.00 - 590.00 Hz)

Note:

- The upper limit value changes when the E1-04 [Maximum Output Frequency] and d2-01 [Frequency Reference Upper Limit] values change.
- When A1-02 = 6, 7 [Control Method Selection = AOLV/PM, CLV/PM], the drive sets o1-03 = 1 [0.01% (100% = E1-04)].

◆ **d2: Reference Limits**

d2 parameters set the upper and lower frequency limits to control the motor speed. Apply these parameters to for example, run the motor at low-speed due to mechanical strength concerns, or if the motor should not be run at low speed because of lubrication issues with the gears and bearings.

The upper frequency limit is set in d2-01 [Frequency Reference Upper Limit] and the lower limit is set in d2-02 [Frequency Reference Lower Limit].

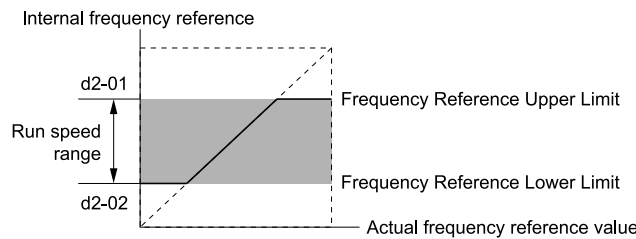

Figure 12.63 Upper and Lower Frequency Limits

■ **d2-01: Frequency Reference Upper Limit**

No. (Hex.)	Name	Description	Default (Range)
d2-01 (0289)	Frequency Reference Upper Limit	V/f CL-V/f OLV CLV AOLV OLV/PM AOLV/PM CLV/PM EZOLV Sets maximum limit for all frequency references. The maximum output frequency is 100%.	100.0% (0.0 - 110.0%)

When the frequency reference is more than the value set in d2-01 the drive will continue to operate at the value set in d2-01.

■ **d2-02: Frequency Reference Lower Limit**

No. (Hex.)	Name	Description	Default (Range)
d2-02 (028A)	Frequency Reference Lower Limit	V/f CL-V/f OLV CLV AOLV OLV/PM AOLV/PM CLV/PM EZOLV Sets minimum limit for all frequency references. The maximum output frequency is 100%.	0.0% (0.0 - 110.0%)

When the frequency reference is less than the value set in d2-02, the drive will continue to operate at the value set in d2-02. The motor will accelerate to the d2-02 value after the drive receives a Run command and a lower frequency reference than d2-02 has been entered.

■ **d2-03: Analog Frequency Ref Lower Limit**

No. (Hex.)	Name	Description	Default (Range)
d2-03 (0293)	Analog Frequency Ref Lower Limit	V/f CL-V/f OLV CLV AOLV OLV/PM AOLV/PM CLV/PM EZOLV Sets the lower limit for the master frequency reference (the first frequency of the multi-step speed reference) as a percentage. The maximum output frequency is 100%.	0.0% (0.0 - 110.0%)

This parameter does not change the lower limit of Jog reference, frequency reference for multi-step speed operation, or the auxiliary frequency reference.

The drive operates at the value set in d2-03 when the frequency reference decreases to less than the value set in d2-03.

Note:

When lower limits are set to parameters *d2-02* [Frequency Reference Lower Limit] and *d2-03*, the drive uses the larger value as the lower limit.

◆ d3: Jump Frequency

The Jump frequency is a function that sets the dead band to a specified frequency band. If a machine that operated at constant speed is operated with variable speed, it can make resonance. To operate the machine without resonance from the natural frequency of the machinery mechanical system, use a frequency band jump.

You can program the drive to have three different Jump frequencies. Set *d3-01* [Jump Frequency 1] to *d3-03* [Jump Frequency 3] to the center value for the frequency to avoid and set *d3-04* [Jump Frequency Width] to be 1/2 of the total band to avoid.

When you input a frequency reference that is the same as or near the Jump frequency width, the frequency reference changes automatically.

The drive accelerates or decelerates the motor smoothly until the frequency reference is not in the range of the Jump frequency band. The drive will use the active accel/decel time to go through the specified dead band range. If the frequency reference is not in the range of the Jump frequency band, switch to constant speed operation.

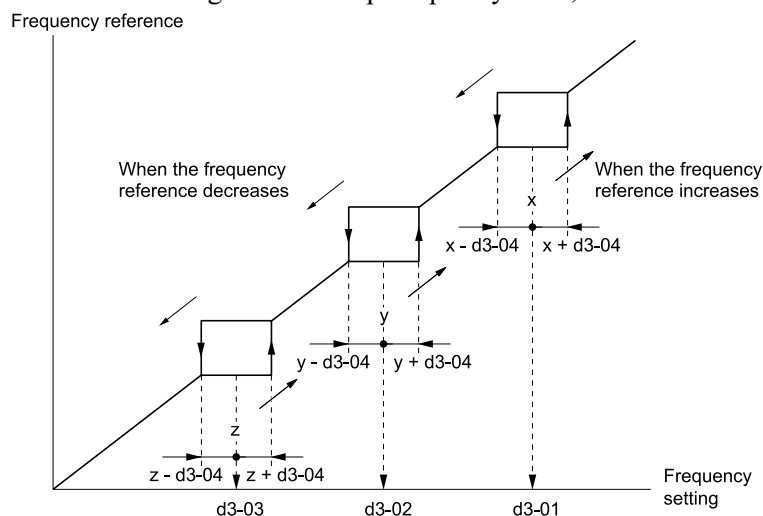

Figure 12.64 Jump Frequency

Note:

- When you set Jump Frequencies 1 to 3, make sure that the parameters do not overlap. The drive will not indicate this condition.
- When the drive is in the range of the Jump frequency, the frequency reference changes automatically. When the drive jumps frequencies, the output frequency changes smoothly as specified by the values set in *C1-01* [Acceleration Time 1] and *C1-02* [Deceleration Time 1].

■ d3-01: Jump Frequency 1

No. (Hex.)	Name	Description	Default (Range)
d3-01 (0294)	Jump Frequency 1	V/f CL-V/f OLV CLV AOLV OLV/PM AOLV/PM CLV/PM EZOLV Sets the median value of the frequency band that the drive will avoid.	0.0 Hz (Determined by A1-02)

Note:

Set this parameter to 0.0 Hz to disable the Jump frequency.

■ d3-02: Jump Frequency 2

No. (Hex.)	Name	Description	Default (Range)
d3-02 (0295)	Jump Frequency 2	V/f CL-V/f OLV CLV AOLV OLV/PM AOLV/PM CLV/PM EZOLV Sets the median value of the frequency band that the drive will avoid.	0.0 Hz (Determined by A1-02)

Note:

Set this parameter to 0.0 Hz to disable the Jump frequency.

■ d3-03: Jump Frequency 3

No. (Hex.)	Name	Description	Default (Range)
d3-03 (0296)	Jump Frequency 3	V/f CL-V/f OLV CLV AOLV OLV/PM AOLV/PM CLV/PM EZOLV Sets the median value of the frequency band that the drive will avoid.	0.0 Hz (Determined by A1-02)

Note:

Set this parameter to 0.0 Hz to disable the Jump frequency.

■ d3-04: Jump Frequency Width

No. (Hex.)	Name	Description	Default (Range)
d3-04 (0297)	Jump Frequency Width	V/f CL-V/f OLV CLV AOLV OLV/PM AOLV/PM CLV/PM EZOLV Sets the width of the frequency band that the drive will avoid.	1.0 Hz (Determined by A1-02)

◆ d4: Frequency Ref Up/Down & Hold

The *d4 parameters* set the Frequency Reference Hold function and Up/Down and Up/Down 2 commands.

WARNING! Sudden Movement Hazard. When you use the drive in a lifting application, you must also install external safety circuitry. The drive does not have protection against accidental load drops in lifting applications. Install electrical and/or mechanical safety circuit mechanisms that are isolated from the drive circuitry. If you do not use external safety circuitry, the drive could drop the load and cause serious injury or death.

WARNING! Sudden Movement Hazard. When you use a mechanical holding brake with the drive in a lifting application, you must close the brake if an input terminal triggers the Baseblock command to stop drive output. If you enter the baseblock command, the motor will suddenly coast and the load will slip, which can cause serious injury or death.

- Frequency Reference Hold Function Command: This acceleration/deceleration ramp hold command uses an MFDI to momentarily stop the acceleration/deceleration of the motor, and continues to operate the motor at the output frequency at which the command reference was input. Turn OFF the acceleration/deceleration ramp hold command to continue acceleration/deceleration.
With a crane for example, use the function and a 2-stage push button to stop acceleration and operate at low speed with one of the output frequencies.
- Up/Down command: The Up/Down command is a function to activate and deactivate an MFDI to increase and decrease the frequency reference. The Up/Down command overrides frequency references from the analog input terminal, pulse train input terminal, and keypad.
- Up/Down 2 command: The Up/Down 2 command is a function that adds a set bias value to the frequency reference to accelerate or decelerate. The Up/Down 2 command activates and deactivates the MFDI to add a bias value.

■ d4-01: Freq Reference Hold Selection

No. (Hex.)	Name	Description	Default (Range)
d4-01 (0298)	Freq Reference Hold Selection	V/f CL-V/f OLV CLV AOLV OLV/PM AOLV/PM CLV/PM EZOLV Sets the function that saves the frequency reference or the frequency bias (Up/Down 2) after a Stop command or when de-energizing the drive.	0 (0, 1)

Set *H1-xx [MFDI Function Selection]* to one of these values to enable this parameter:

- *A [Accel/Decel Ramp Hold]*
- *10/11 [Up/Down Command]*
- *75/76 [Up/Down 2 Command]*

0 : Disabled

- Acceleration/Deceleration Ramp Hold
When you enter a Stop command or de-energize the drive, the hold value is reset to 0 Hz. The drive will use the active frequency reference when it restarts.
- Up/Down Command
When you enter a Stop command or de-energize the drive, the frequency reference value is reset to 0 Hz. The drive will start from 0 Hz when it restarts.
- Up/Down 2 Command
When you enter the Stop command or 5 s after you release the Up/Down 2 command, the drive does not save the frequency bias. The Up/Down 2 function will start with a bias of 0% when the drive restarts.

1 : Enabled

- Acceleration/Deceleration Ramp Hold

When you clear the Run command or de-energize the drive, it will save the last hold value. The drive will use the saved value as the frequency reference when it restarts.

Note:

When you energize the drive, continuously enable the MFDI terminal set for *Accel/Decel Ramp Hold* [$H1-xx = A$]. If the digital input does not activate, the drive will clear the hold value and set it to 0 Hz.

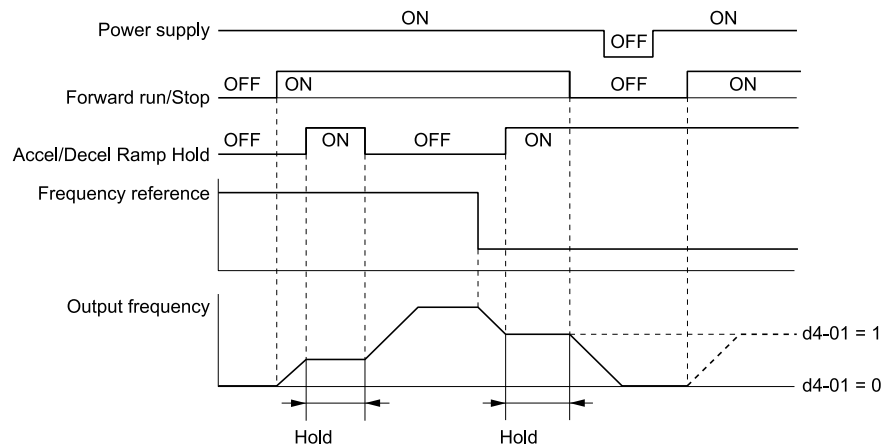

Figure 12.65 Frequency Reference Hold with Accel/Decel Hold Function

- Up/Down Command

When you clear the Run command or de-energize the drive, it will save the frequency reference value. The drive will use the saved value as the frequency reference when it restarts.

- Up/Down 2 Command with Frequency Reference from Keypad

When a Run command is active and you release the Up/Down 2 command for longer than 5 s, the drive adds the Up/Down 2 bias value to the frequency reference and sets it to 0. The drive saves the frequency reference value to which the bias value was added. The drive will use the new value as the frequency reference when it restarts.

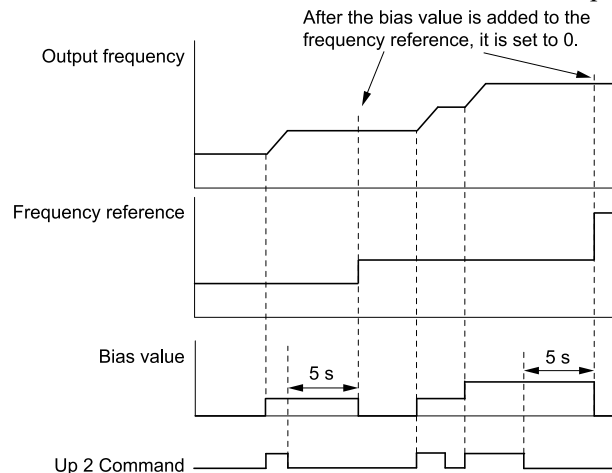

Figure 12.66 Up/Down 2 Example with Reference from Keypad and d4-01 = 1

- Up/Down 2 Command with Frequency Reference from Input Sources Other Than the Keypad

When a Run command is active and you release the Up/Down 2 command for longer than 5 s, the drive will save the bias value in $d4-06$ [*Frequency Ref Bias (Up/Down 2)*]. The drive saves the frequency reference + $d4-06$ as a frequency reference value. The drive will use the new value as the frequency reference when it restarts.

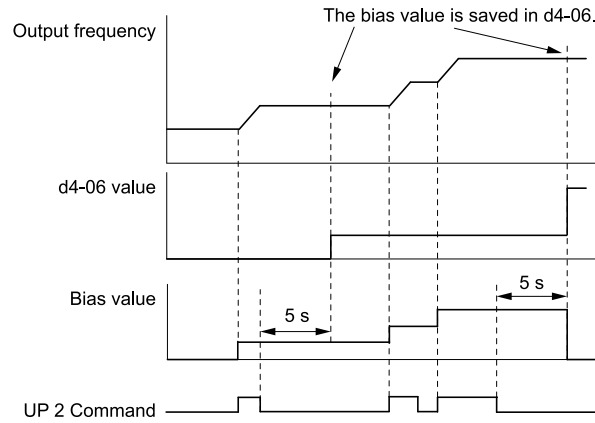

Figure 12.67 Up/Down 2 Example with Other Reference than Keypad and d4-01 = 1

Note:

To use the combination of the frequency reference hold function and the Up/Down 2 function, configure the Up/Down 2 upper limit [d4-08] and lower limit [d4-09] correctly.

Remove the Saved Frequency Reference Value

The procedure to remove the saved frequency reference value is different for different functions. Use these methods to remove the value:

- Release the input programmed for *Accel/Decel Ramp Hold* [H1-xx = A].
- Set an Up or Down command while no Run command is active.
- Use the Up/Down 2 Command to set d4-06 = 0.0 or set d4-06 = 0.0 during stop.

■ d4-03: Up/Down 2 Bias Step Frequency

No. (Hex.)	Name	Description	Default (Range)
d4-03 (02AA) RUN	Up/Down 2 Bias Step Frequency	V/f CL-V/f OLV CLV AOLV OLV/PM AOLV/PM CLV/PM EZOLV Sets the bias that the Up/Down 2 function adds to or subtracts from the frequency reference.	0.00 Hz (0.00 - 99.99 Hz)

The operation is different for different setting values:

• Setting d4-03 = 0.00 Hz

When the *Up/Down 2 Command* [H1-xx = 75, 76] is active, the drive uses the accel/decel times set in d4-04 [*Up/Down 2 Ramp Selection*] to increase or decrease the bias value.

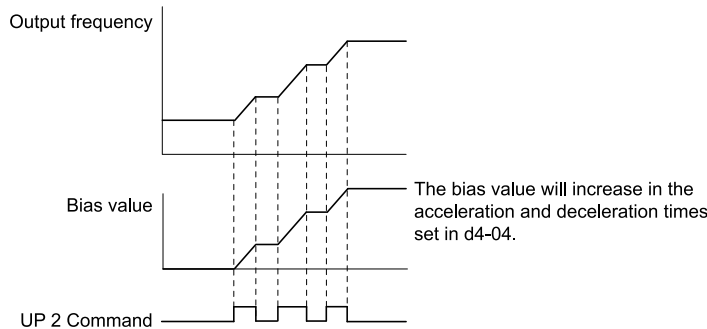

Figure 12.68 Up/Down 2 Bias when d4-03 = 0.00 Hz

• Setting d4-03 ≠ 0.00 Hz

When the *Up/Down 2 Command* [H1-xx = 75, 76] is active, the drive increases or decreases the bias in steps for the value set in d4-03. The drive uses the acceleration and deceleration times set in d4-04.

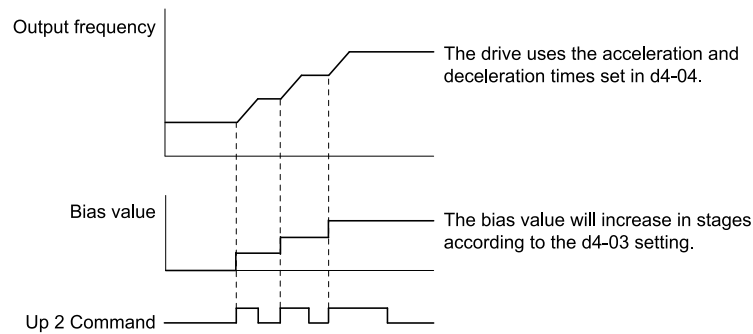

Figure 12.69 Up/Down 2 Bias when d4-03 ≠ 0.00 Hz

■ d4-04: Up/Down 2 Ramp Selection

No. (Hex.)	Name	Description	Default (Range)
d4-04 (02AB) RUN	Up/Down 2 Ramp Selection	V/f CL-V/f OLV CLV AOLV OLV/PM AOLV/PM CLV/PM EZOLV Sets the acceleration and deceleration times for the Up/Down 2 function to apply the bias to the frequency reference.	0 (0, 1)

0 : Use Selected Accel/Decel Time

Use the active acceleration and deceleration times to increase or decrease the bias.

1 : Use Accel/Decel Time 4

Use C1-07 [Acceleration Time 4] and C1-08 [Deceleration Time 4] to increase or decrease the bias.

■ d4-05: Up/Down 2 Bias Mode Selection

No. (Hex.)	Name	Description	Default (Range)
d4-05 (02AC) RUN	Up/Down 2 Bias Mode Selection	V/f CL-V/f OLV CLV AOLV OLV/PM AOLV/PM CLV/PM EZOLV Sets the function that saves the bias value to the drive when you open or close the two Up/Down 2 Commands [H1-xx = 75, 76]. Set d4-03 [Up/Down 2 Bias Step Frequency] = 0.00 before you set this parameter.	0 (0, 1)

0 : Hold when Neither Up/Down Closed

When the two MFDI terminals set for Up/Down 2 Command [H1-xx = 75, 76] activate or deactivate, the drive will hold the bias value.

1 : Reset when Neither / Both Closed

When the two MFDI terminals set for Up/Down 2 Command [H1-xx = 75, 76] activate or deactivate, the drive will reset the bias value to 0. The drive will use the acceleration and deceleration times set in d4-04 [Up/Down 2 Ramp Selection] to accelerate and decelerate the motor to the selected output frequency.

■ d4-06: Frequency Ref Bias (Up/Down 2)

No. (Hex.)	Name	Description	Default (Range)
d4-06 (02AD)	Frequency Ref Bias (Up/Down 2)	V/f CL-V/f OLV CLV AOLV OLV/PM AOLV/PM CLV/PM EZOLV Saves the bias value from the Up/Down 2 Command where the Maximum Output Frequency is 100%.	0.0% (-99.9 - +100.0%)

The Up/Down 2 function setting changes the function of d4-06:

Note:

When the keypad sets the frequency reference, you do not usually use parameter d4-06.

- When d4-01 = 0 [Freq Reference Hold Selection = Disabled] and a source other than the keypad sets the frequency reference, the drive adds the value set in d4-06 to the frequency reference. If the value set in d4-06 is a negative number, the drive will subtract it from frequency reference.
- When d4-01 = 1 [Enabled] and a source other than the keypad sets the frequency reference, the drive will store the bias value adjusted with the Up/Down 2 command in d4-06 5 seconds after you release the Up/Down 2 command. The drive adds or subtracts the value set in d4-06 to the frequency reference.

Conditions that Reset or Disable d4-06

The drive resets and disables the bias value in these conditions:

- d4-01 = 0 and the Run command was cleared.

- $H1-xx = 75, 76$ [MFDI Function Select = Up/Down 2 Command] is not set.
- The frequency reference source was changed.
This includes switching LOCAL/REMOTE and multi-step speed reference.
- A digital input changed the frequency reference value.
- $d4-03$ [Up/Down 2 Bias Step Frequency] = 0 and $d4-05 = 1$ [Up/Down 2 Bias Mode Selection = Reset when Neither / Both Closed], and the two MFDI terminals set for Up/Down 2 Command [$H1-xx = 75/76$] are activated or deactivated.
- The value of $E1-04$ [Maximum Output Frequency] was changed.

■ **d4-07: Analog Freq Ref Fluctuate Limit**

No. (Hex.)	Name	Description	Default (Range)
d4-07 (02AE) RUN	Analog Freq Ref Fluctuate Limit	<div style="display: flex; justify-content: space-between; font-size: 0.8em; font-weight: bold; background-color: #f0f0f0; padding: 2px;"> V/f CL-V/f OLV CLV AOLV OLV/PM AOLV/PM CLV/PM EZOLV </div> <p>If the frequency reference changes for more than the level set to this parameter, then the bias value will be held. The value is set as a percentage of the Maximum Output Frequency.</p>	1.0% (0.1 - 100.0%)

Handles frequency reference changes while Up/Down 2 Command [$H1-xx = 75, 76$] is activated. When the frequency reference changes for more than the level set in $d4-07$, the drive will hold the bias value, and the drive will accelerate or decelerate to the frequency reference. When the drive is at the frequency reference, it releases the bias hold and the bias follows the Up/Down 2 input commands.

This parameter is applicable only when an analog or pulse input sets the frequency reference.

■ **d4-08: Up/Down 2 Bias Upper Limit**

No. (Hex.)	Name	Description	Default (Range)
d4-08 (02AF) RUN	Up/Down 2 Bias Upper Limit	<div style="display: flex; justify-content: space-between; font-size: 0.8em; font-weight: bold; background-color: #f0f0f0; padding: 2px;"> V/f CL-V/f OLV CLV AOLV OLV/PM AOLV/PM CLV/PM EZOLV </div> <p>Sets the upper limit of the Up/Down 2 bias as a percentage of the Maximum Output Frequency.</p>	100.0% (0.0 - 100.0%)

The drive saves the set bias upper limit in $d4-06$ [Frequency Ref Bias (Up/Down 2)]. Set $d4-08$ an applicable value before you use the Up/Down 2 function.

Note:

When $d4-01 = 1$ [Freq Reference Hold Selection = Enabled] and $b1-01 = 0$ [Frequency Reference Selection 1 = Keypad], the drive will add the bias value to the frequency reference when it does not receive an Up/Down 2 command for 5 s. Then the drive will reset the value to 0 at which time you can increase the bias to the limit set in $d4-08$ again.

■ **d4-09: Up/Down 2 Bias Lower Limit**

No. (Hex.)	Name	Description	Default (Range)
d4-09 (02B0) RUN	Up/Down 2 Bias Lower Limit	<div style="display: flex; justify-content: space-between; font-size: 0.8em; font-weight: bold; background-color: #f0f0f0; padding: 2px;"> V/f CL-V/f OLV CLV AOLV OLV/PM AOLV/PM CLV/PM EZOLV </div> <p>Sets the lower limit of the Up/Down 2 bias as a percentage of the Maximum Output Frequency.</p>	0.0% (-99.9 - 0.0%)

The drive saves the set bias lower limit in $d4-06$ [Frequency Ref Bias (Up/Down 2)]. Set $d4-09$ to an applicable value before you use the Up/Down 2 function.

Note:

When $d4-01 = 1$ [Freq Reference Hold Selection = Enabled] and $b1-01 = 0$ [Frequency Reference Selection 1 = Keypad], the drive will add the bias value to the frequency reference when it does not receive an Up/Down 2 command for 5 s. Then the drive will reset the value to 0.

If you increase the bias with the Up 2 command and $d4-09 = 0$, you cannot use a Down 2 command to decrease the frequency reference. To decrease speed in this condition, set a negative lower limit in $d4-09$.

■ **d4-10: Up/Down Freq Lower Limit Select**

No. (Hex.)	Name	Description	Default (Range)
d4-10 (02B6)	Up/Down Freq Lower Limit Select	<div style="display: flex; justify-content: space-between; font-size: 0.8em; font-weight: bold; background-color: #f0f0f0; padding: 2px;"> V/f CL-V/f OLV CLV AOLV OLV/PM AOLV/PM CLV/PM EZOLV </div> <p>Sets the lower frequency limit for the Up/Down function.</p>	0 (0, 1)

0 : Greater of d2-02 or Analog

The higher value between $d2-02$ [Frequency Reference Lower Limit] and an analog input programmed for Frequency Reference [$H3-02, H3-06, H3-10 = 0$] sets the lower frequency reference limit.

Note:

When you use *External Reference 1/2 Selection* [$H1-xx = 2$] to switch between the Up/Down function and an analog input as the reference source, the analog value becomes the lower reference limit when the Up/Down command is active. Set $d4-10 = 1$ to isolate the Up/Down function and the analog input value.

1 : d2-02

You can only use $d2-02$ to set the lower limit of the frequency reference.

■ d4-11: Bi-directional Output Selection

No. (Hex.)	Name	Description	Default (Range)
d4-11 (02B7)	Bi-directional Output Selection	<div style="display: flex; gap: 5px;"> V/f CL-V/f OLV CLV AOLV OLV/PM AOLV/PM CLV/PM EZOLV </div> Sets the function that changes the frequency reference to a Bi-Directional internal frequency reference.	0 (0, 1)

0 : Disabled

The drive will not change the frequency reference or PID output value to Bi-Directional internal frequency reference.

When the frequency reference or PID output value is 0% to 100% of the maximum output frequency, the drive runs the motor in the set direction.

1 : Enabled

Changes the frequency reference or PID output value to Bi-Directional output.

When the frequency reference or PID output value is 0% to 50%, the drive reverses the motor in the set direction. When the frequency reference or PID output value is 50% to 100%, the drive operates the motor in the set direction.

Note:

When you use the Bi-Directional function with PID control, you can use an MFDI terminal set for *PID Bi-Directional Enable* [$H1-xx = 7F$] to enable/disable the Bi-Directional function.

Table 12.42 shows how the drive operates when you use the PID control function with the Bi-Directional function and $d4-11 = 1$:

Table 12.42 Bi-Directional Function Operation Conditions

b5-01 [PID Mode Setting] Setting	Status of MFDI Terminal Set for 7F [PID Bi-Directional Enable]	
	ON	OFF
b5-01 = 0 [Disabled]	Bi-Directional function enabled	Bi-Directional function enabled
b5-01 ≠ 0 [Enabled]	Bi-Directional function enabled	Normal operation (Bi-Directional function disables)

- **When PID Control is Disabled or $H1-xx = 19$ [MFDI Function Select = PID Disable] is Activated**

When the frequency reference is 0% to 50%, the drive reverses the motor in the set direction. When the frequency reference is 50% to 100%, the drive operates the motor in the set direction. Figure 12.70 shows the frequency reference change at this time. This is an example of operation when the Forward Run command is input.

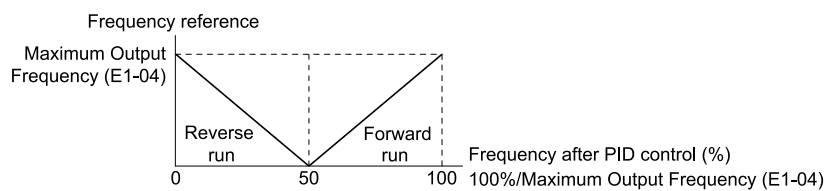
**Figure 12.70 Frequency Reference Transition when PID Control is Disabled or PID Disable is ON****Note:**

When $b1-04 = 1$ [Reverse Operation Selection = Reverse Disabled], the drive will not run in Reverse. The frequency reference limit is 0 Hz.

- **When PID Control is Enabled and $H1-xx = 7F$ [PID Bi-Directional Enable] is Activated**

The Bi-Directional function is enabled. When the frequency reference is 0% to 50% after PID control execution, the drive runs the motor opposite of the set direction. When the frequency reference is 50% to 100%, the drive runs the motor in the set direction. Figure 12.71 shows the frequency reference change at this time. This is an example of the operation when the Forward Run command is input.

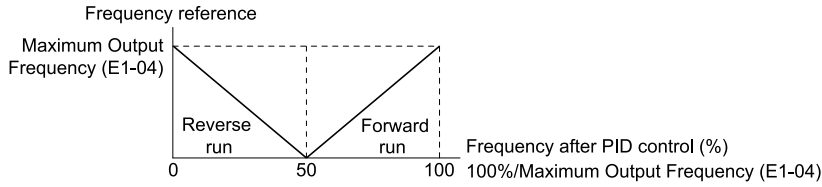

Figure 12.71 Frequency Reference Transition when PID Control and PID Bi-Directional are Enabled

Note:

When $b1-04 = 1$, the drive will not run the motor in Reverse. The frequency reference limit is 0 Hz.

• **When PID Control is Enabled and $H1-xx = 7F$ is Deactivated**

The Bi-Directional function is disabled. When the frequency reference is a negative value after PID control execution, the drive runs the motor opposite of the set direction. The frequency reference value is an absolute value.

■ **d4-12: Stop Position Gain**

No. (Hex.)	Name	Description	Default (Range)
d4-12 (02B8)	Stop Position Gain	<div style="display: flex; justify-content: space-between; font-size: small;"> V/f CL-V/f OLV CLV AOLV OLV/PM AOLV/PM CLV/PM EZOLV </div> <p>Sets the gain to adjust the stopping accuracy. Set this parameter when $b1-03 = 9$ [Stopping Method Selection = Stop with Constant Distance].</p>	1.00 (0.50 - 2.55)

If the motor stops before the necessary stop position, increase the setting value. If the length of time for the motor to stop is too long, decrease the setting value.

◆ **d5: Torque Control**

$d5$ parameters set the Torque Control function.

The Torque Control function controls the output torque of the motor. You can use Torque Control for roller drives, winders, unwinders, conveyors and other machines that use tension control and push/pull applications. When there is no more material and the machine suddenly has no load, the drive uses Torque Control and the speed limit function to keep the rotation speed of the motor from increasing.

Set $A1-02$ [Control Method Selection] to one of these values to use Torque Control:

- 3 [Closed Loop Vector]
- 4 [Advanced Open Loop Vector]
- 6 [PM Advanced Open Loop Vector]
- 7 [PM Closed Loop Vector]

Note:

When you use Torque Control and $A1-02 = 4$, use a motor designed for winding applications.

Use one of these methods to enable Torque Control:

- Set $d5-01 = 1$ [Torque Control Selection = Torque Control].
- Set $H1-xx = 71$ [Torque Control] ON.

■ **Torque Control Operation**

Figure 12.72 shows the operation principle of Torque Control.

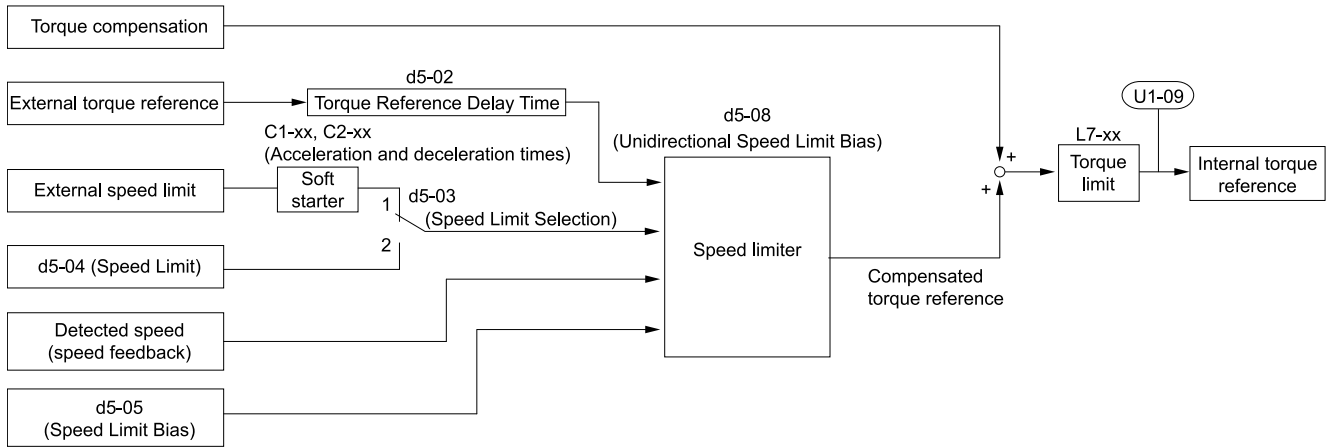

Figure 12.72 Torque Control Block Diagram

The externally input torque reference is the target value for the motor output torque. If the motor output torque and load torque are not balanced during Torque Control, the motor accelerates or decelerates. To prevent operation beyond the speed limit, the drive corrects the external torque reference if the motor speed reaches the speed limit. The speed limit, speed feedback, and the speed limit bias are the values that calculate the compensation value.

When an external torque compensation value is input, the drive adds that value to the speed limit compensated torque reference value. The values *L7-01 to L7-04* [Torque Limit] limit the resulting torque reference. The drive uses the value as the internal torque reference. You can use *U1-09* [Torque Reference] to monitor the calculated torque reference. The torque limit values set in *L7-01 to L7-04* are most important. Although you can set a higher external torque reference from an external source, the motor will not operate a torque output higher than the values set in *L7-01 to L7-04*.

■ Setting the Torque Reference, Speed Limit, and Torque Compensation Values

Torque Control Input Value Selection

Table 12.43 lists the method for torque control input signals.

Table 12.43 The Method for Torque Control Input Signals

Configuration Parameter	Signal Input Method	Parameter Settings	Notes
Torque Reference	Drive analog input terminals A1, A2, A3	<i>H3-02, H3-10, H3-06 = 13</i> [MFAI Function Select = Torque Reference / Torque Limit] *	The level of the set input signal must align with the polarity of the external signals.
	Analog reference option cards AI-A3	<ul style="list-style-type: none"> <i>F2-01 = 0</i> [Analog Input Function Selection = 3 Independent Channels] <i>H3-02, H3-10, and H3-06 = 13</i> * 	<i>H3-02, H3-10, or H3-06</i> settings are enabled for the option card input terminal. The level of the set input signal must align with the polarity of the external signals.
	MEMOBUS register 0004H	<ul style="list-style-type: none"> <i>b1-01 = 2</i> [Frequency Reference Selection 1 = Memobus/Modbus Communications] When register bit 2 of 000FH = 1, the torque reference and torque limit from register 0004H is enabled. 	-
	Communication option card	<ul style="list-style-type: none"> <i>b1-01 = 3</i> [Option PCB] <i>F6-06 = 1</i> [Torque Reference/Limit by Comm = Enabled] Refer to the communication option card manual for more information about the torque reference setting.	-
Speed Limit	Frequency Reference Selection (Reference source selected with b1-01)	<i>d5-03 = 1</i> [Speed Limit Selection = Active Frequency Reference] The drive gets the speed limit from the frequency reference source input in <i>b1-01</i> or <i>b1-15</i> [Frequency Reference Selection 2]. *1	The drive applies the settings in <i>C1-01 to C1-08</i> [Acceleration/Deceleration Times] and <i>C2-01 to C2-04</i> [S-Curve Time @ Start/End of Accel/Decel] to the speed limit.
	<i>d5-04</i> [Speed Limit]	<i>d5-03 = 2</i> [<i>d5-04</i> Setting]	-

Configuration Parameter	Signal Input Method	Parameter Settings	Notes
Torque Compensation	Drive analog input terminals A1, A2, A3	<i>H3-02, H3-10, or H3-06 = 14 [Torque Compensation] *1</i>	The level of the set input signal must align with the polarity of the external signals.
	Analog reference option cards AI-A3	<ul style="list-style-type: none"> <i>F2-01 = 0</i> <i>H3-02, H3-10, or H3-06 = 14 *1</i> 	<i>H3-02, H3-10, or H3-06</i> settings are enabled for the option card input terminal. The level of the set input signal must align with the polarity of the external signals.
	MEMOBUS register 0005H	<ul style="list-style-type: none"> <i>b1-01 = 2</i> When register bit 3 of 000FH = 1, the torque reference and torque limit from register 0005H is enabled. 	-
	Communication option card	<i>b1-01 = 3</i> Refer to the communication option card manual for more information about the torque reference setting.	-

*1 Sets analog input terminals A1, A2, and A3 to supply the speed limit, torque reference, or torque compensation. If you set the same function to A1 to A3 terminals with *H3-02, H3-10, or H3-06*, the drive will detect *oPE07 [Analog Input Selection Error]*.

Input Signal Polarity

The positive and negative torque references set the motor rotation direction. The direction of the Run command does not set it. The positive and negative torque reference signals and the direction of the Run command have an effect on the internal torque reference.

Table 12.44 Torque Control Signal Polarity

Run Command Direction	Torque Reference Signal Polarity	Direction of Motor Rotation	Polarity of the Internal Torque Reference [U1-09]
Forward run	+ (Positive)	Forward direction	+ (Positive)
	- (Negative)	Reverse direction	- (Negative)
Reverse run	+ (Positive)	Reverse direction	- (Negative)
	- (Negative)	Forward direction	+ (Positive)

Note:

For Yaskawa motors, the forward run direction is counterclockwise direction when seen from the load shaft.

When you use analog inputs, you can get negative input values with these methods:

- Apply negative voltage input signals.
- Use positive voltage input signals and set the analog input bias to negative values.
- Apply positive voltage input signals and use a digital input programmed for *Analog TorqueRef Polarity Invert [H1-xx = 78]*.

When you use MEMOBUS/Modbus communication or a communication option card, set the positive or negative signed torque reference.

When the level of the analog signal input is 0 V to 10 V or 4 mA to 20 mA, the torque reference is the forward direction. To reverse the polarity of the torque reference, use one of these two methods:

- Use a -10 V to +10 V voltage input
- Set *H1-xx = 78 [MFDI Function Select = Analog TorqueRef Polarity Invert]*.

■ Speed Limit and Speed Limit Bias

The drive reads the speed limit setting from the input selected in *d5-03 [Speed Limit Selection]*. You can use *d5-05 [Speed Limit Bias]* to add a bias to this speed. Parameter *d5-08 [Uni-directional Speed Limit Bias]* sets how the drive applies bias to the speed limit.

Table 12.45 shows the relation between these settings:

Table 12.45 Speed Limit, Speed Bias and Speed Limit Priority Selection

Run command	Operating Conditions							
	Forward	Reverse	Forward	Reverse	Forward	Reverse	Forward	Reverse
Torque reference direction	+ (Positive)	+ (Positive)	- (Negative)	- (Negative)	- (Negative)	- (Negative)	+ (Positive)	+ (Positive)
Speed limit direction	+ (Positive)	- (Negative)	- (Negative)	+ (Positive)	+ (Positive)	- (Negative)	- (Negative)	+ (Positive)
Direction of motor rotation	Forward		Reverse		Forward		Reverse	

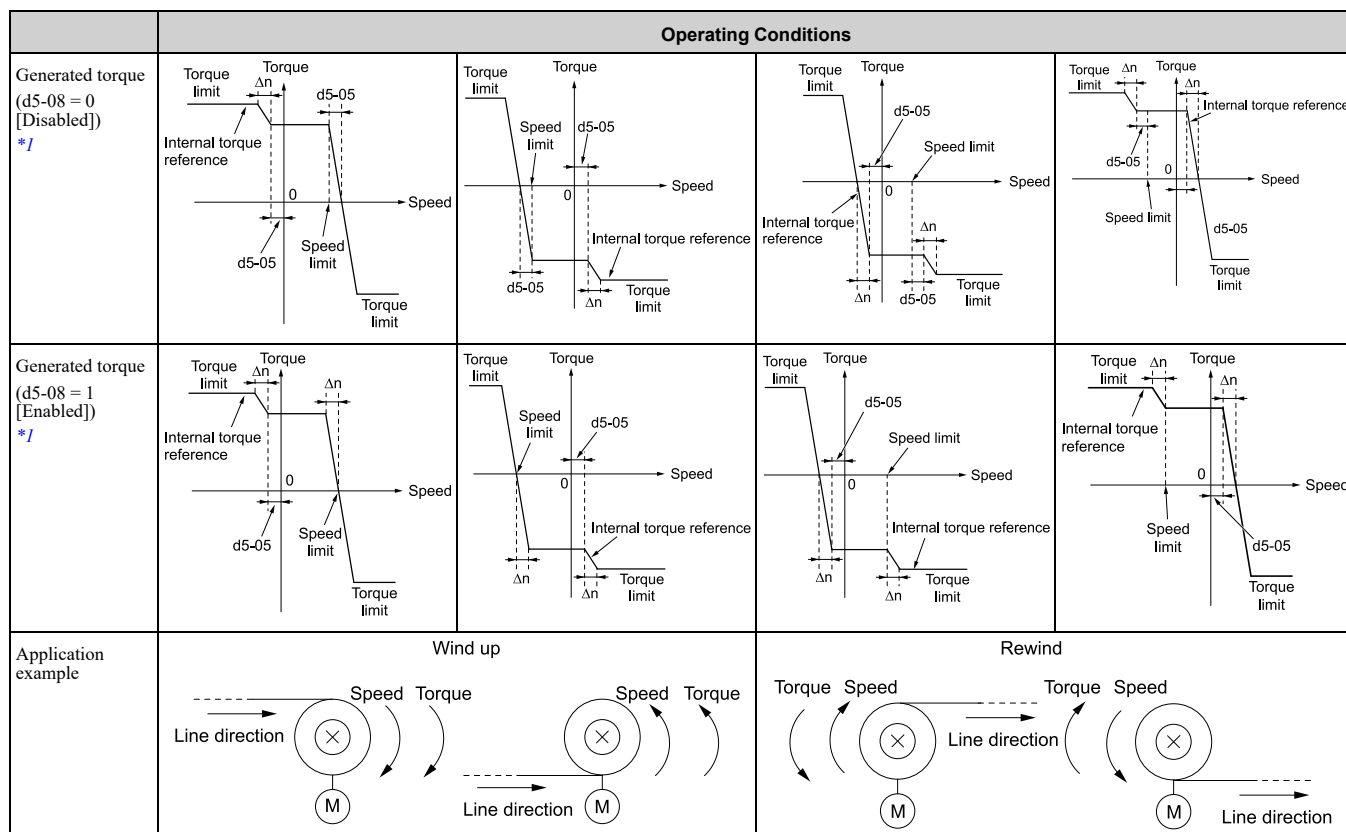

*1 The C5 parameter set the Δn value.

■ Show Speed Limit Operation

When the motor is at the speed limit or more than the speed limit, the drive sends a signal to the PLC or other such control devices to tell you that an error has occurred. To enable this function, set an MFDO function [H2-01 to H2-03] to 32 [In Speed Limit During Trq Ctrl].

■ Switch Between Torque Control and Speed Control

Use a digital input to switch Torque Control and Speed Control. To enable this function, set H1-xx = 71 [MFDI Function Select = Torque Control] to enable this function.

When you switch from Speed Control to Torque Control, the torque limit becomes the torque reference and the speed reference becomes the speed limit. When you switch from Torque Control to Speed Control, the torque reference becomes the torque limit and the speed limit becomes the speed reference. When you must use a delay time to switch between Speed Control and Torque Control, set d5-06 [Speed/Torque Changeover Time]. During this switch delay time, the drive keeps the reference value of the Torque Control and Speed Control when the switch signal was input. Change the reference values from an external control device during this delay time.

Note:

- When you switch between Torque Control and Speed Control, set d5-01 = 0 [Torque Control Selection = Speed Control]. If d5-01 = 1 [Torque Control] and H1-xx = 71 at the same time, the drive will detect oPE15 [Torque Control Setting Error].
- If the Stop command is input, the drive will not apply the delay time set in d5-06. Torque Control will immediately switch to Speed Control and ramp to stop.

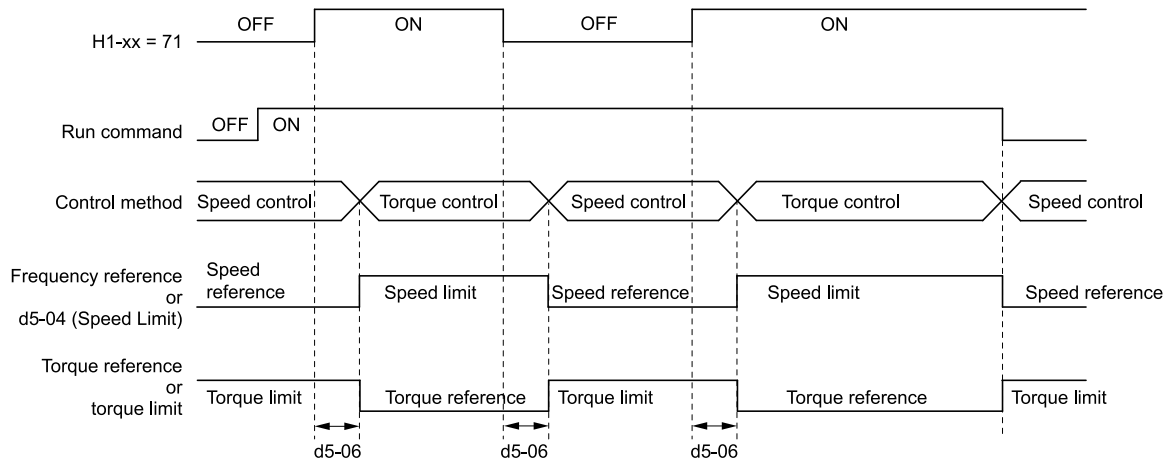

Figure 12.73 Speed/Torque Control Switching Time

■ d5-01: Torque Control Selection

No. (Hex.)	Name	Description	Default (Range)
d5-01 (029A)	Torque Control Selection	<input type="checkbox"/> V/f <input type="checkbox"/> CL-V/f <input type="checkbox"/> OLV <input checked="" type="checkbox"/> CLV <input type="checkbox"/> AOLV <input type="checkbox"/> OLV/PM <input type="checkbox"/> AOLV/PM <input type="checkbox"/> CLV/PM <input type="checkbox"/> EZOLV Sets the drive for torque control or speed control.	0 (0, 1)

0 : Speed Control

Enables Speed Control. The drive controls the speed as specified by C5-01 to C5-07 [Speed Control (ASR) Setting Parameters].

Also use this setting when you use H1-xx = 71 [MFDI Function Select = Torque Control] to change between Speed Control and Torque Control.

1 : Torque Control

Always enables Torque Control.

■ d5-02: Torque Reference Delay Time

No. (Hex.)	Name	Description	Default (Range)
d5-02 (029B)	Torque Reference Delay Time	<input type="checkbox"/> V/f <input type="checkbox"/> CL-V/f <input type="checkbox"/> OLV <input checked="" type="checkbox"/> CLV <input type="checkbox"/> AOLV <input type="checkbox"/> OLV/PM <input type="checkbox"/> AOLV/PM <input type="checkbox"/> CLV/PM <input type="checkbox"/> EZOLV Sets the primary delay time constant for the torque reference filter.	Determined by A1-02 (0 - 1000 ms)

This parameter applies a primary delay filter to the torque reference signal to stop oscillation caused by a torque reference signal that is not stable. This also helps remove electrical interference from the torque reference signal and helps adjust the responsiveness between host controllers.

If oscillation occurs during Torque Control, increase the setting value. If the setting value is too high, responsiveness becomes unsatisfactory.

■ d5-03: Speed Limit Selection

No. (Hex.)	Name	Description	Default (Range)
d5-03 (029C)	Speed Limit Selection	<input type="checkbox"/> V/f <input type="checkbox"/> CL-V/f <input type="checkbox"/> OLV <input checked="" type="checkbox"/> CLV <input type="checkbox"/> AOLV <input type="checkbox"/> OLV/PM <input type="checkbox"/> AOLV/PM <input type="checkbox"/> CLV/PM <input type="checkbox"/> EZOLV Sets the torque control speed limit method.	1 (1, 2)

1 : Active Frequency Reference

The enabled frequency reference set in b1-01 [Frequency Reference Selection 1] or b1-15 [Frequency Reference Selection 2] will be the speed limit. The drive applies the values set in C1-01 to C1-08 [Acceleration/Deceleration Times 1 to 4] and C2-01 to C2-04 [S-Curve Time @ Start/End of Accel] as speed limits.

2 : d5-04 Setting

The speed limit is the value set in d5-04.

■ d5-04: Speed Limit

No. (Hex.)	Name	Description	Default (Range)
d5-04 (029D)	Speed Limit	<div style="display: flex; justify-content: space-between; align-items: center;"> V/f CL-V/f OLV CLV AOLV OLV/PM AOLV/PM CLV/PM EZOLV </div> <p>Sets the speed limit during Torque Control as a percentage of <i>E1-04 [Maximum Output Frequency]</i>. Set <i>d5-03 = 2 [Speed Limit Selection = d5-04 Setting]</i> before you set this parameter.</p>	0% (-120 - +120%)

The speed limit is a positive value when it is in the same direction as the Run command. The speed limit is a negative value when it is in the opposite direction of the Run command.

■ d5-05: Speed Limit Bias

No. (Hex.)	Name	Description	Default (Range)
d5-05 (029E)	Speed Limit Bias	<div style="display: flex; justify-content: space-between; align-items: center;"> V/f CL-V/f OLV CLV AOLV OLV/PM AOLV/PM CLV/PM EZOLV </div> <p>Sets the speed limit bias value as a percentage of <i>E1-04 [Maximum Output Frequency]</i>.</p>	10% (0 - 120%)

Adjusts the margin for the speed limit.

■ d5-06: Speed/Torque Changeover Time

No. (Hex.)	Name	Description	Default (Range)
d5-06 (029F)	Speed/Torque Changeover Time	<div style="display: flex; justify-content: space-between; align-items: center;"> V/f CL-V/f OLV CLV AOLV OLV/PM AOLV/PM CLV/PM EZOLV </div> <p>Sets the delay time to switch between Speed Control and Torque Control. Set <i>H1-xx = 71 [MFDI Function Selection = Torque Control]</i> before you set this parameter.</p>	0 ms (0 - 1000 ms)

The analog input (torque reference, speed limit value) holds at the value when the drive switched between Speed and Torque Control in the time of the Speed/Torque Changeover Timer. During this time, prepare to switch to an external source.

■ d5-08: Uni-directional Speed Limit Bias

No. (Hex.)	Name	Description	Default (Range)
d5-08 (02B5)	Uni-directional Speed Limit Bias	<div style="display: flex; justify-content: space-between; align-items: center;"> V/f CL-V/f OLV CLV AOLV OLV/PM AOLV/PM CLV/PM EZOLV </div> <p>Sets the direction of the speed limit reference to which Speed Limit Bias [<i>d5-05</i>] applies.</p>	1 (0, 1)

0 : Disabled

The drive applies the speed limit bias in the speed limit direction and the opposite direction.

1 : Enabled

The drive applies the speed limit bias in the opposite direction of the speed limit only.

◆ d6: Field Weakening /Forcing

d6 parameters set the field weakening and field forcing functions.

The field weakening function decreases the energy consumption of the motor. It decreases the output voltage of the drive to a set level. The function decreases the motor excitation current inversely proportional to speed in a constant output range, and does not let the induced voltage of the motor become more than the power supply voltage. To enable this function, set *Field Weakening [H1-xx = 63]* ON.

Note:

Use the Field Weakening function in constant light-load applications. To control the energy consumption of the motor for other load conditions, use the *b8 parameters [Energy Saving]*.

The Field Forcing function adjusts the delaying influence of the motor time constant when the drive changes the excitation current reference and it also increases motor responsiveness. This function uses a high motor excitation current reference for drive start-up only to help develop actual motor excitation current. Enable the Field Forcing function to increase motor responsiveness.

Note:

You cannot use Field Forcing during DC Injection Braking.

■ d6-01: Field Weakening Level

No. (Hex.)	Name	Description	Default (Range)
d6-01 (02A0)	Field Weakening Level	<div style="display: flex; justify-content: space-between; font-size: 0.8em;"> V/f CL-V/f OLV CLV AOLV OLV/PM AOLV/PM CLV/PM EZOLV </div> <p>Sets the drive output voltage as a percentage of <i>E1-05 [Maximum Output Voltage]</i> when <i>H1-xx = 63 [Field Weakening]</i> is activated.</p>	80% (0 - 100%)

■ d6-02: Field Weakening Frequency Limit

No. (Hex.)	Name	Description	Default (Range)
d6-02 (02A1)	Field Weakening Frequency Limit	<div style="display: flex; justify-content: space-between; font-size: 0.8em;"> V/f CL-V/f OLV CLV AOLV OLV/PM AOLV/PM CLV/PM EZOLV </div> <p>Sets the minimum output frequency to start field weakening.</p>	0.0 Hz (0.0 - 590.0 Hz)

Make sure that these two conditions are correct to enable the Field Weakening command:

- The output frequency \geq *d6-02*.
- There is a speed agreement status.

■ d6-03: Field Forcing Selection

No. (Hex.)	Name	Description	Default (Range)
d6-03 (02A2)	Field Forcing Selection	<div style="display: flex; justify-content: space-between; font-size: 0.8em;"> V/f CL-V/f OLV CLV AOLV OLV/PM AOLV/PM CLV/PM EZOLV </div> <p>Sets the field forcing function.</p>	0 (0, 1)

0 : Disabled

1 : Enabled

■ d6-06: Field Forcing Limit

No. (Hex.)	Name	Description	Default (Range)
d6-06 (02A5)	Field Forcing Limit	<div style="display: flex; justify-content: space-between; font-size: 0.8em;"> V/f CL-V/f OLV CLV AOLV OLV/PM AOLV/PM CLV/PM EZOLV </div> <p>Sets the limit value for field forcing to increase the motor excitation current reference as a percentage of <i>E2-03 [Motor No-Load Current]</i>. Usually it is not necessary to change this setting.</p>	400% (100 - 400%)

Note:

You cannot use Field Forcing during DC Injection Braking.

◆ d7: Offset Frequency

The drive will use 3 digital signal inputs to add or subtract the set frequency (offset frequency) to/from the frequency reference and correct the speed. The drive uses the terminal set in *H1-xx = 44 to 46 [MFDI Function Selection = Add Offset Frequency 1 (d7-01) to Add Offset Frequency 3 (d7-03)]* to set the offset frequency. When you close more than one input at the same time, the drive adds the selected offset values together.

Figure 12.74 shows the Offset frequency function:

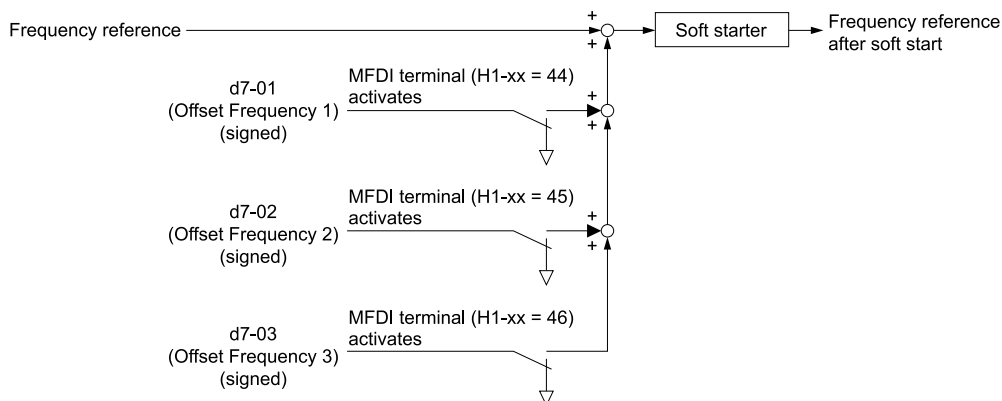

Figure 12.74 Offset Frequency Operation

■ d7-01: Offset Frequency 1

No. (Hex.)	Name	Description	Default (Range)
d7-01 (02B2) RUN	Offset Frequency 1	<p>V/f CL-V/f OLV CLV AOLV OLV/PM AOLV/PM CLV/PM EZOLV</p> <p>Uses $H1-xx = 44$ [MFDI Function Select = Add Offset Frequency 1 (d7-01)] as a percentage of the Maximum Output Frequency to add or subtract the set frequency to/from the frequency reference.</p>	0.0% (-100.0 - +100.0%)

■ d7-02: Offset Frequency 2

No. (Hex.)	Name	Description	Default (Range)
d7-02 (02B3) RUN	Offset Frequency 2	<p>V/f CL-V/f OLV CLV AOLV OLV/PM AOLV/PM CLV/PM EZOLV</p> <p>Uses $H1-xx = 45$ [MFDI Function Select = Add Offset Frequency 2 (d7-02)] as a percentage of the Maximum Output Frequency to add or subtract the set frequency to/from the frequency reference.</p>	0.0% (-100.0 - +100.0%)

■ d7-03: Offset Frequency 3

No. (Hex.)	Name	Description	Default (Range)
d7-03 (02B4) RUN	Offset Frequency 3	<p>V/f CL-V/f OLV CLV AOLV OLV/PM AOLV/PM CLV/PM EZOLV</p> <p>Uses $H1-xx = 46$ [MFDI Function Select = Add Offset Frequency 3 (d7-03)] as a percentage of the Maximum Output Frequency to add or subtract the set frequency to/from the frequency reference.</p>	0.0% (-100.0 - +100.0%)

12.6 E: Motor Parameters

E parameters cover drive input voltage, V/f pattern, and motor parameters.

◆ E1: V/f Pattern for Motor 1

E1 parameters set the drive input voltage and motor V/f characteristics. To switch drive operation from one motor to another motor, set the V/f characteristics for motor 1.

■ V/f Pattern Settings

The drive uses a V/f pattern to adjust the output voltage relative to the frequency reference.

This product has been preconfigured with 15 voltage/frequency (V/f) patterns. Use *E1-03* [*V/f Pattern Selection*] to select the V/f pattern that is appropriate for the application.

Additionally, one custom V/f pattern is available. Set *E1-03* = *F* [*Custom*] and then manually set parameters *E1-04* to *E1-10*.

Table 12.46 Predefined V/f Patterns

Setting Value	Specification	Characteristic	Application
0	Const Trq, 50Hz base, 50Hz max	Constant torque	For general purpose applications. This pattern is used when the load torque is constant without any rotation speed such as that used for linear conveyor systems.
1	Const Trq, 60Hz base, 60Hz max		
2	Const Trq, 50Hz base, 60Hz max		
3	Const Trq, 60Hz base, 72Hz max		
4	VT, 50Hz, 65% Vmid reduction	Derated Torque characteristics	This pattern is used for torque loads proportional to 2 or 3 times the rotation speed, such as is the case with fans and pumps.
5	VT, 50Hz, 50% Vmid reduction		
6	VT, 60Hz, 65% Vmid reduction		
7	VT, 60Hz, 50% Vmid reduction		
8	High Trq, 50 Hz, 25% Vmin boost	High starting torque	This pattern is used when strong torque is required during startup.
9	High Trq, 50 Hz, 65% Vmin boost		
A	High Trq, 60 Hz, 25% Vmin boost		
B	High Trq, 60 Hz, 65% Vmin boost		
C	High Freq, 60Hz base, 90Hz max	Constant output	This pattern is used to rotate motors at greater than 60 Hz. Output voltage is constant when operating at greater than 60 Hz.
D	High Freq, 60Hz base, 120Hz max		
E	High Freq, 60Hz base, 180Hz max		
F	Custom	Constant torque	Enables a custom V/f pattern by changing <i>E1-04</i> to <i>E1-13</i> [<i>V/f Pattern for Motor 1</i>]. The default settings for <i>E1-04</i> to <i>E1-13</i> are the same as Setting Value 1 [<i>Const Trq, 60Hz base, 60Hz max</i>].

Note:

When you manually set V/f patterns, note these items:

- To set linear V/f characteristics at frequencies lower than E1-06 [Base Frequency], set E1-07 = E1-09 [Mid Point A Frequency = Minimum Output Frequency]. In this application, the drive ignores E1-08 [Mid Point A Voltage].
- Set the five frequencies as specified by these rules: Incorrect settings will cause oPE10 [V/f Data Setting Error].
 $E1-09 \leq E1-07 < E1-06 \leq E1-11 \leq E1-04$ [Minimum Output Frequency \leq Mid Point A Frequency $<$ Base Frequency \leq Mid Point B Frequency \leq Maximum Output Frequency]
- Setting E1-11 = 0 [Mid Point B Frequency = 0 Hz] disables E1-12 [Mid Point B Voltage]. Ensure that the four frequencies are set according to the following rules;
 $E1-09 \leq E1-07 < E1-06 \leq E1-04$
- When you use A1-03 [Initialize Parameters] to initialize the drive, it will not reset E1-03.

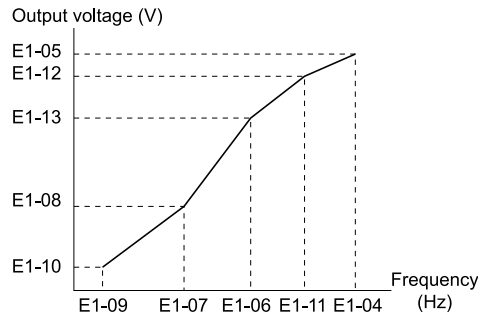

Figure 12.75 V/f Pattern

■ E1-01: Input AC Supply Voltage

No. (Hex.)	Name	Description	Default (Range)
E1-01 (0300)	Input AC Supply Voltage	V/f CL-V/f OLV CLV AOLV OLV/PM AOLV/PM CLV/PM EZOLV Sets the drive input voltage.	200 V Class: 230 V, 400 V Class: 400 V (200 V Class: 155 to 255 V, 400 V Class: 310 to 510 V)

NOTICE: Damage to Equipment. Set E1-01 [Input AC Supply Voltage] to align with the drive input voltage (not motor voltage). If this parameter is incorrect, the protective functions of the drive will not operate correctly and it can cause damage to the drive.

Values Related to the Drive Input Voltage

The value set in E1-01 is the base value that the drive uses for the motor protective functions in Table 12.47. With a 400 V class drive, the detection level changes for some motor protective functions.

Table 12.47 Values Related to the Drive Input Voltage

Voltage	E1-01 Setting	Approximate Values				
		ov Detection Level	BTR Operation Level (rr Detection Level) *	L2-05 [Undervoltage Detection Lvl (Uv1)]	L2-11 [KEB DC Bus Voltage Setpoint]	L3-17 [DC Bus Regulation Level]
200 V Class	All settings	410 V	394 V	190 V	260 V	375 V
400 V Class	Setting value \geq 400 V	820 V	788 V	380 V	500 V	750 V
	Setting value $<$ 400 V	820 V	788 V	350 V	460 V	750 V

*1 This is the protection function enabled in drives with built-in braking transistors. These values show the level that will trigger the built-in braking transistor. Refer to “YASKAWA AC Drive Series Option Braking Unit and Braking Resistor Unit Installation Manual (TOBPC72060001)” for more information.

■ E1-03: V/f Pattern Selection

No. (Hex.)	Name	Description	Default (Range)
E1-03 (0302)	V/f Pattern Selection	V/f CL-V/f OLV CLV AOLV OLV/PM AOLV/PM CLV/PM EZOLV Sets the V/f pattern for the drive and motor. You can use one of the preset patterns or you can make a custom pattern.	F (Determined by A1-02)

Note:

- When A1-02 = 2 [Control Method Selection = OLV], settings 0 to E are not available.
- Set the correct V/f pattern for the application and operation area. An incorrect V/f pattern can decrease motor torque and increase current from overexcitation.
- Parameter A1-03 [Initialize Parameters] will not reset the value of E1-03.

0 : Const Trq, 50Hz base, 50Hz max

Use this constant torque pattern for general applications. This pattern is used when the load torque is constant without any rotation speed such as that used for linear conveyor systems.

Note:

The voltage values in the figures are for 200 V class drives. Multiply the values by 2 for 400 V class drives.

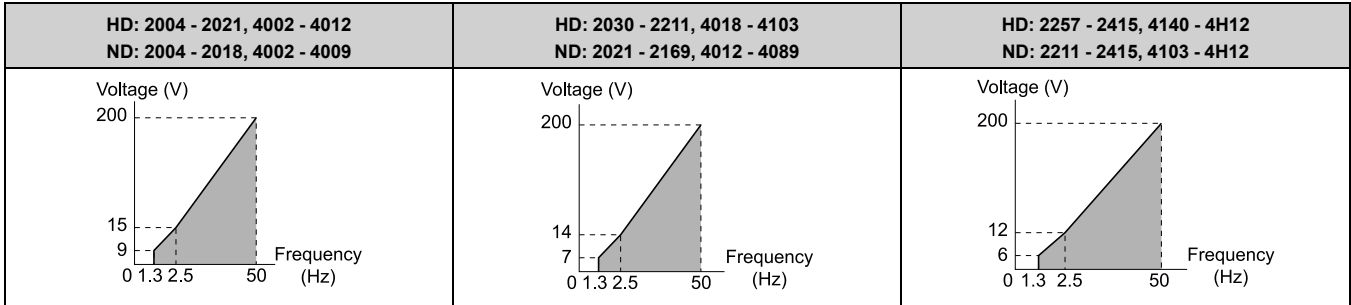

1 : Const Trq, 60Hz base, 50Hz max

Use this constant torque pattern for general applications. This pattern is used when the load torque is constant without any rotation speed such as that used for linear conveyor systems.

Note:

The voltage values in the figures are for 200 V class drives. Multiply the values by 2 for 400 V class drives.

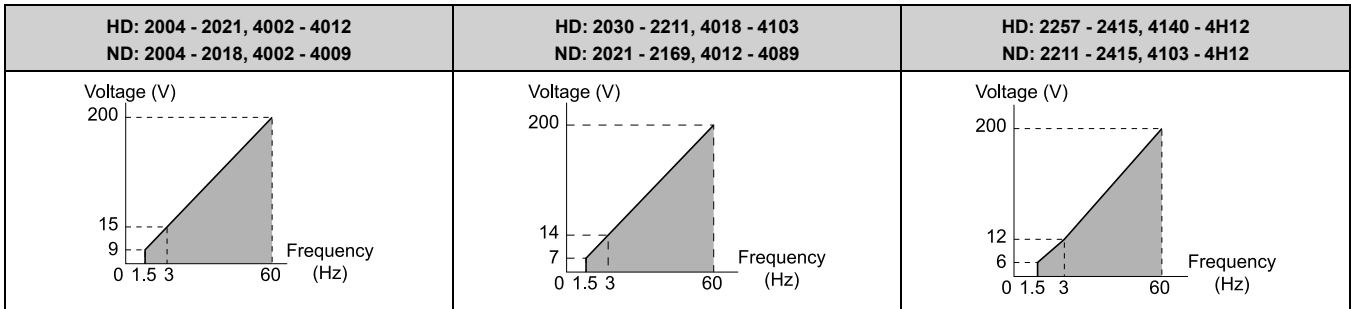

2 : Const Trq, 50Hz base, 60Hz max

Use this constant torque pattern for general applications. This pattern is used when the load torque is constant without any rotation speed such as that used for linear conveyor systems.

Note:

The voltage values in the figures are for 200 V class drives. Multiply the values by 2 for 400 V class drives.

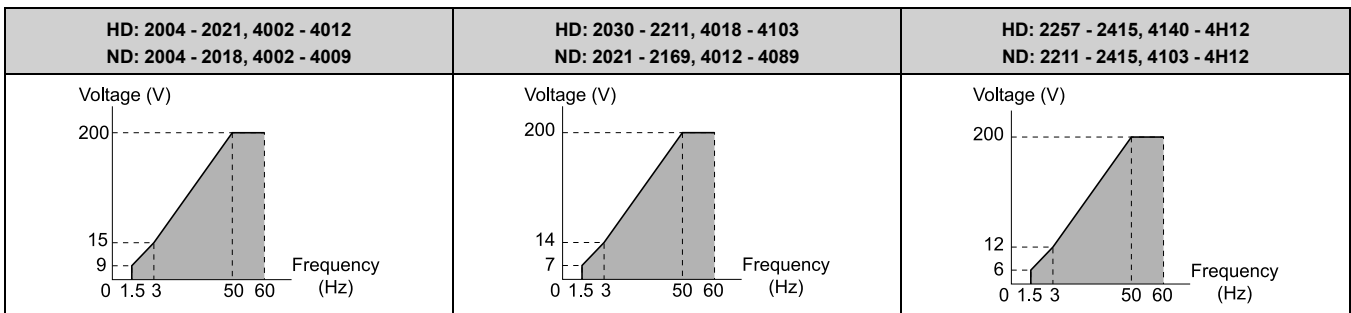

3 : Const Trq, 60Hz base, 72Hz max

Use this constant torque pattern for general applications. This pattern is used when the load torque is constant without any rotation speed such as that used for linear conveyor systems.

Note:

The voltage values in the figures are for 200 V class drives. Multiply the values by 2 for 400 V class drives.

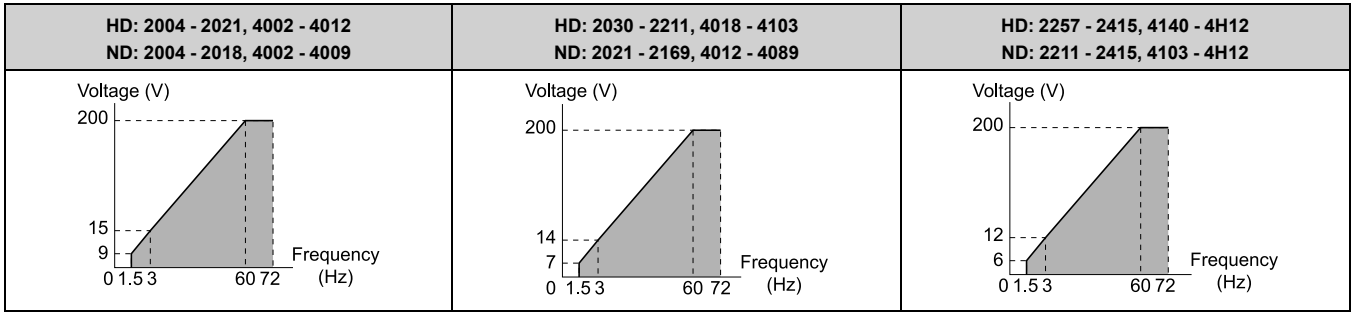

4 : VT, 50Hz, 65% Vmid reduction

Use this derated torque pattern for torque loads proportional to three times the rotation speed. For example, fans and pumps.

Note:

The voltage values in the figures are for 200 V class drives. Multiply the values by 2 for 400 V class drives.

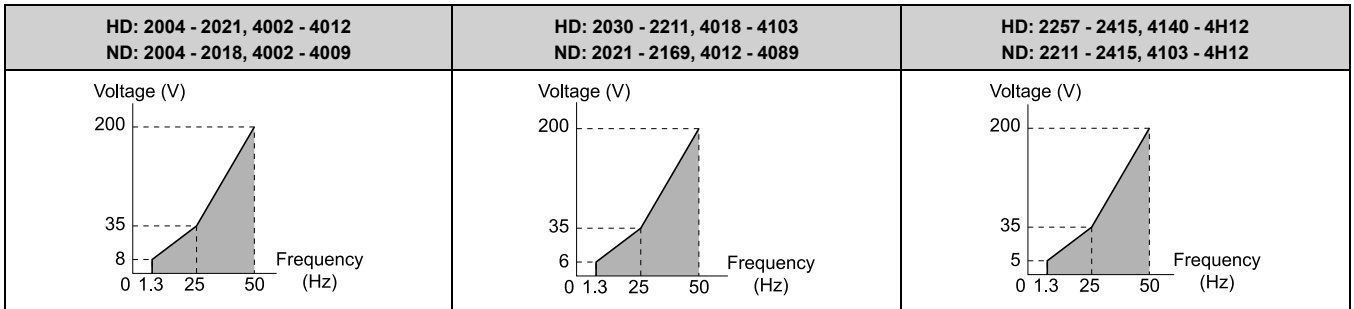

5 : VT, 50Hz, 50% Vmid reduction

Use this derated torque pattern for torque loads proportional to two times the rotation speed. For example, fans and pumps.

Note:

The voltage values in the figures are for 200 V class drives. Multiply the values by 2 for 400 V class drives.

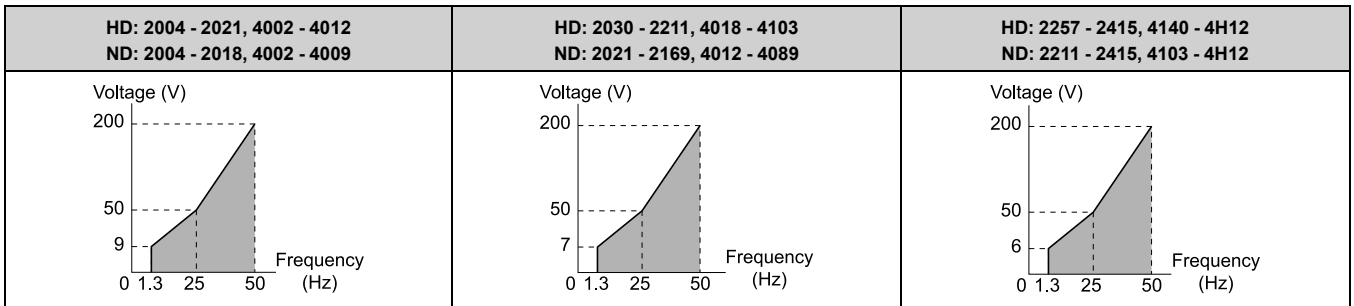

6 : VT, 60Hz, 65% Vmid reduction

Use this derated torque pattern for torque loads proportional to three times the rotation speed. For example, fans and pumps.

Note:

The voltage values in the figures are for 200 V class drives. Multiply the values by 2 for 400 V class drives.

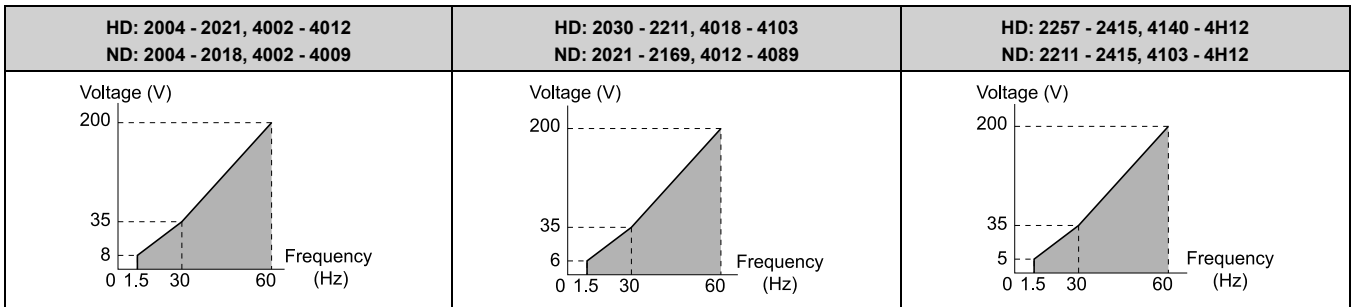

7 : VT, 60Hz, 50% Vmid reduction

Parameter Details

12.6 E: Motor Parameters

Use this derated torque pattern for torque loads proportional to two times the rotation speed. For example, fans and pumps.

Note:

The voltage values in the figures are for 200 V class drives. Multiply the values by 2 for 400 V class drives.

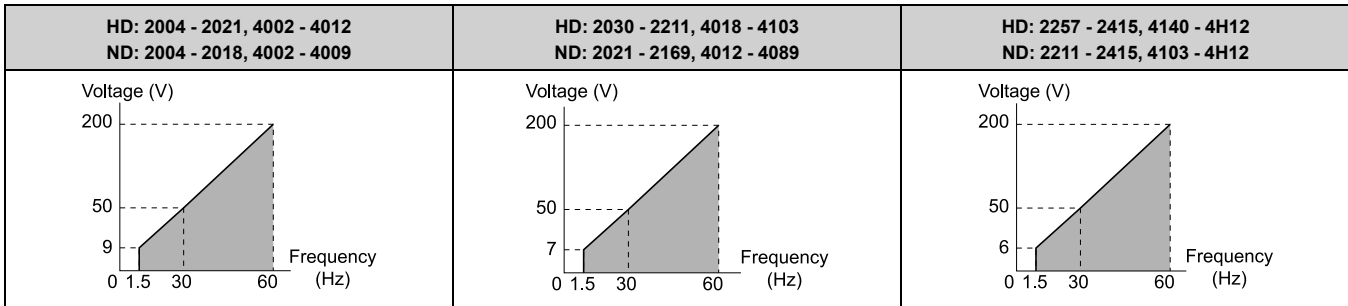

8 : High Trq, 50 Hz, 25% Vmin Boost

Use this pattern when moderate torque is necessary during start up.

Select this pattern only in these conditions:

- The wiring distance between the drive and motor is 150 m (492.1 ft) minimum
- There is an AC reactor connected to the drive output.
- For more conditions, contact Yaskawa or your nearest sales representative.

Note:

The voltage values in the figures are for 200 V class drives. Multiply the values by 2 for 400 V class drives.

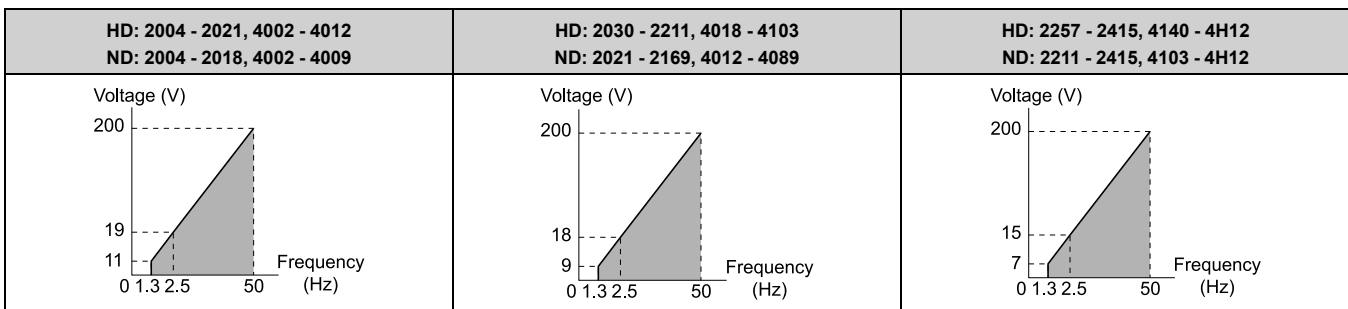

9 : High Trq, 50 Hz, 65% Vmin Boost

Use this pattern when high torque is necessary during start up.

Select this pattern only in these conditions:

- The wiring distance between the drive and motor is 150 m (492.1 ft) minimum
- There is an AC reactor connected to the drive output.
- For more conditions, contact Yaskawa or your nearest sales representative.

Note:

The voltage values in the figures are for 200 V class drives. Multiply the values by 2 for 400 V class drives.

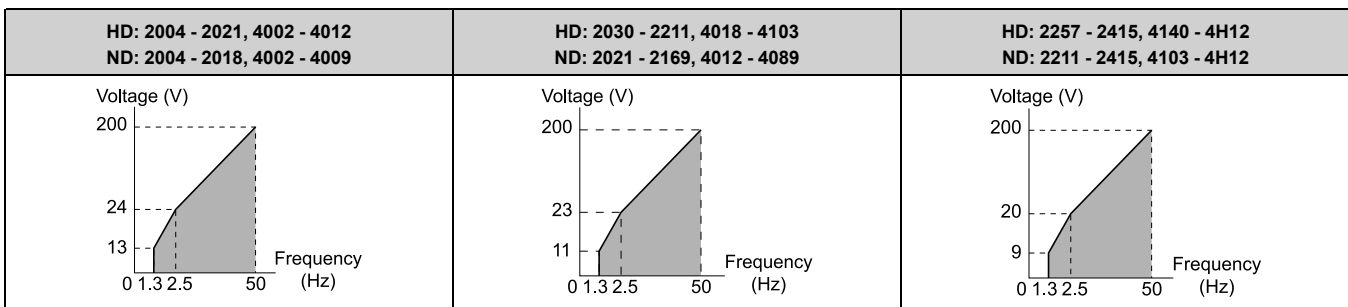

A : High Trq, 60 Hz, 25% Vmin Boost

Use this pattern when moderate torque is necessary during start up.

Select this pattern only in these conditions:

- The wiring distance between the drive and motor is 150 m (492.1 ft) minimum

- There is an AC reactor connected to the drive output.
- For more conditions, contact Yaskawa or your nearest sales representative.

Note:

The voltage values in the figures are for 200 V class drives. Multiply the values by 2 for 400 V class drives.

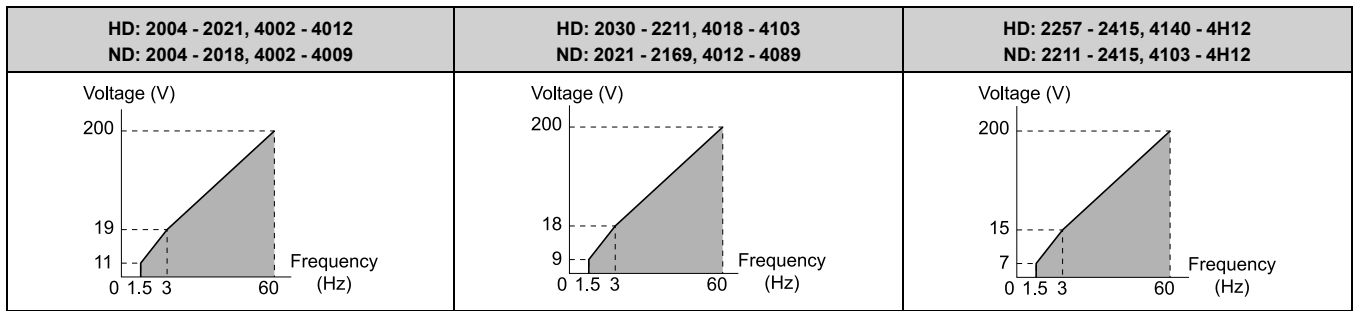

B : High Trq, 60 Hz, 65% Vmin Boost

Use this pattern when high torque is necessary during start up.

Select this pattern only in these conditions:

- The wiring distance between the drive and motor is 150 m (492.1 ft) minimum
- There is an AC reactor connected to the drive output.
- For more conditions, contact Yaskawa or your nearest sales representative.

Note:

The voltage values in the figures are for 200 V class drives. Multiply the values by 2 for 400 V class drives.

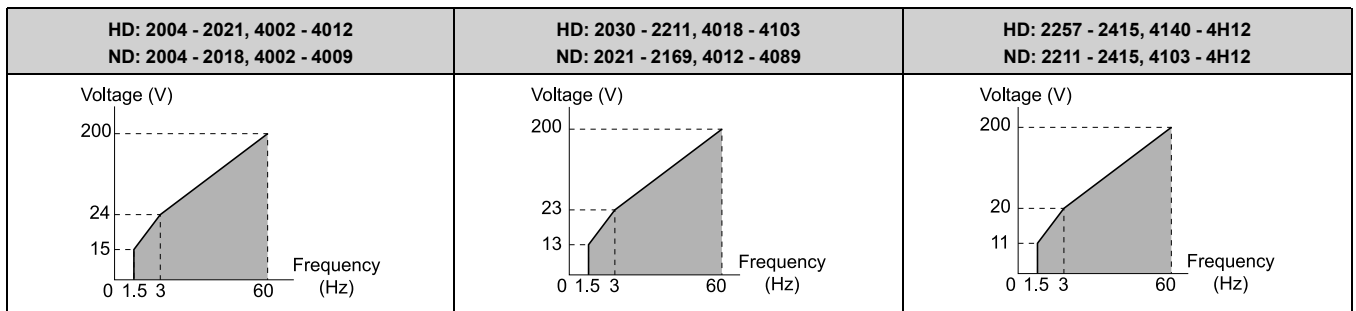

C : Const Trq, 60Hz base, 90Hz max

Use this constant output pattern to rotate motors at more than 60 Hz. Output voltage is constant when you operate at more than 60 Hz.

Note:

The voltage values in the figures are for 200 V class drives. Multiply the values by 2 for 400 V class drives.

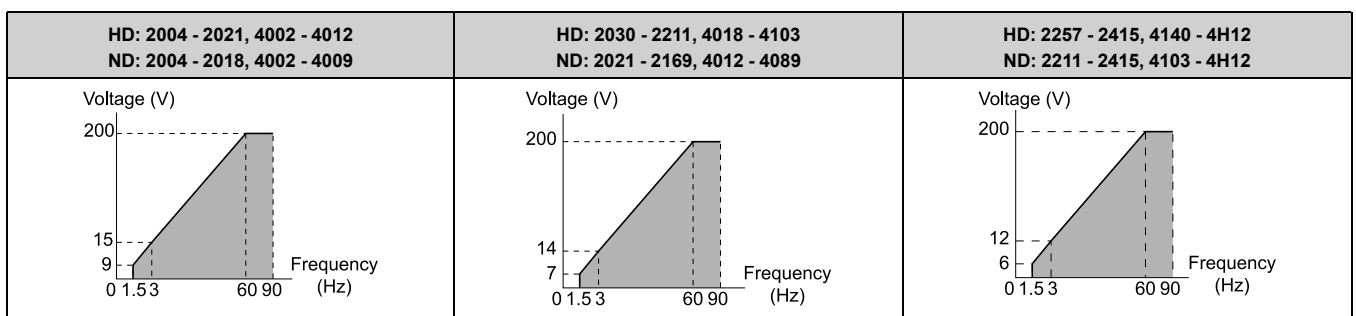

D : Const Trq, 60Hz base, 120Hz max

Use this constant output pattern to rotate motors at more than 60 Hz. Output voltage is constant when you operate at more than 60 Hz.

Note:

The voltage values in the figures are for 200 V class drives. Multiply the values by 2 for 400 V class drives.

12.6 E: Motor Parameters

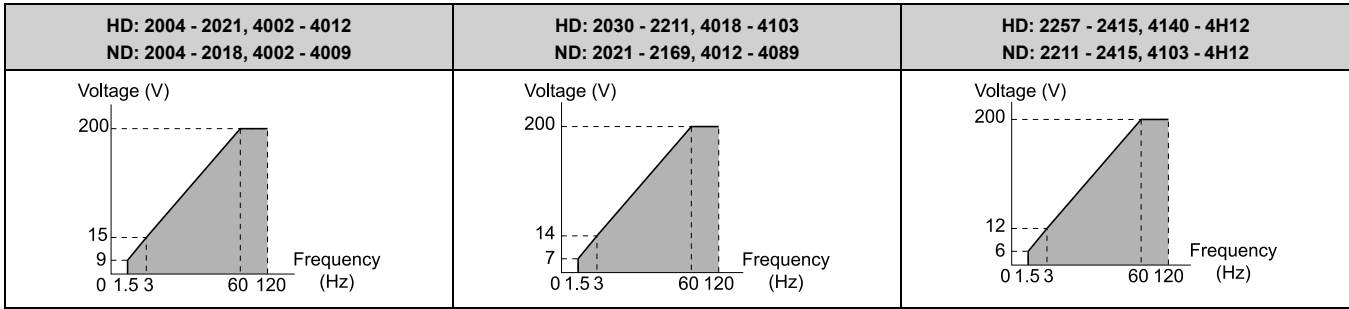

E : Const Trq, 60Hz base, 180Hz max

Use this constant output pattern to rotate motors at more than 60 Hz. Output voltage is constant when you operate at more than 60 Hz.

Note:

The voltage values in the figures are for 200 V class drives. Multiply the values by 2 for 400 V class drives.

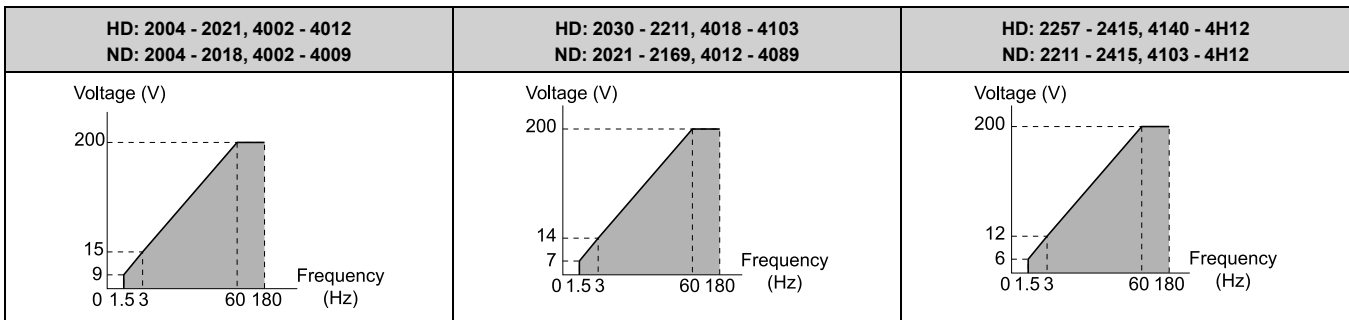

F : Custom

Set *E1-04* to *E1-13* [*V/f Pattern for Motor 1*] to set the values for this custom pattern.

The default settings are the same as *Setting Value 0* [*Const Trq, 50Hz base, 60Hz max*].

■ E1-04: Maximum Output Frequency

No. (Hex.)	Name	Description	Default (Range)
E1-04 (0303)	Maximum Output Frequency	V/f CL-V/f OLV CLV AOLV OLV/PM AOLV/PM CLV/PM EZOLV Sets the maximum output frequency for the V/f pattern.	Determined by A1-02 and E5-01 (Determined by A1-02 and E5-01)

■ E1-05: Maximum Output Voltage

No. (Hex.)	Name	Description	Default (Range)
E1-05 (0304)	Maximum Output Voltage	V/f CL-V/f OLV CLV AOLV OLV/PM AOLV/PM CLV/PM EZOLV Sets the maximum output voltage for the V/f pattern.	200.0 (200 V Class: 0.0 - 255.0 V, 400 V Class: 0.0 - 510.0 V)

■ E1-06: Base Frequency

No. (Hex.)	Name	Description	Default (Range)
E1-06 (0305)	Base Frequency	V/f CL-V/f OLV CLV AOLV OLV/PM AOLV/PM CLV/PM EZOLV Sets the base frequency for the V/f pattern.	Determined by A1-02 and E5-01 (0.0 - E1-04)

■ E1-07: Mid Point A Frequency

No. (Hex.)	Name	Description	Default (Range)
E1-07 (0306)	Mid Point A Frequency	V/f CL-V/f OLV CLV AOLV OLV/PM AOLV/PM CLV/PM EZOLV Sets a middle output frequency for the V/f pattern.	Determined by A1-02 (0.0 - E1-04)

■ E1-08: Mid Point A Voltage

No. (Hex.)	Name	Description	Default (Range)
E1-08 (0307)	Mid Point A Voltage	<div style="display: flex; justify-content: space-between; font-size: 0.8em;"> V/f CL-V/f OLV CLV AOLV OLV/PM AOLV/PM CLV/PM EZOLV </div> Sets a middle output voltage for the V/f pattern.	Determined by A1-02 , C6-01 and o2-04 (200 V Class: 0.0 - 255.0 V, 400 V Class: 0.0 - 510.0 V)

Note:

Default setting is determined by *A1-02 [Control Method Selection]*, *C6-01 [Normal / Heavy Duty Selection]*, and *o2-04 [Drive Model Selection]*.

■ E1-09: Minimum Output Frequency

No. (Hex.)	Name	Description	Default (Range)
E1-09 (0308)	Minimum Output Frequency	<div style="display: flex; justify-content: space-between; font-size: 0.8em;"> V/f CL-V/f OLV CLV AOLV OLV/PM AOLV/PM CLV/PM EZOLV </div> Sets the minimum output frequency for the V/f pattern.	Determined by A1-02 and E5-01 (Determined by A1-02, E1-04, and E5-01)

■ E1-10: Minimum Output Voltage

No. (Hex.)	Name	Description	Default (Range)
E1-10 (0309)	Minimum Output Voltage	<div style="display: flex; justify-content: space-between; font-size: 0.8em;"> V/f CL-V/f OLV CLV AOLV OLV/PM AOLV/PM CLV/PM EZOLV </div> Sets the minimum output voltage for the V/f pattern.	Determined by A1-02 (200 V Class: 0.0 to 255.0 V, 400 V Class: 0.0 to 510.0 V)

■ E1-11: Mid Point B Frequency

No. (Hex.)	Name	Description	Default (Range)
E1-11 (030A) Expert	Mid Point B Frequency	<div style="display: flex; justify-content: space-between; font-size: 0.8em;"> V/f CL-V/f OLV CLV AOLV OLV/PM AOLV/PM CLV/PM EZOLV </div> Sets a middle output frequency for the V/f pattern.	0.0 Hz (0.0 - E1-04)

Note:

Set this parameter to *0.0* to disable the function.

■ E1-12: Mid Point B Voltage

No. (Hex.)	Name	Description	Default (Range)
E1-12 (030B) Expert	Mid Point B Voltage	<div style="display: flex; justify-content: space-between; font-size: 0.8em;"> V/f CL-V/f OLV CLV AOLV OLV/PM AOLV/PM CLV/PM EZOLV </div> Sets a middle point voltage for the V/f pattern.	0.0 V (200 V Class: 0.0 to 255.0 V, 400 V Class: 0.0 to 510.0 V)

Note:

Set this parameter to *0.0* to disable the function.

■ E1-13: Base Voltage

No. (Hex.)	Name	Description	Default (Range)
E1-13 (030C) Expert	Base Voltage	<div style="display: flex; justify-content: space-between; font-size: 0.8em;"> V/f CL-V/f OLV CLV AOLV OLV/PM AOLV/PM CLV/PM EZOLV </div> Sets the base voltage for the V/f pattern.	0.0 V (200 V Class: 0.0 - 255.0 V, 400 V Class: 0.0 - 510.0 V)

Note:

- After Auto-Tuning, the value of *E1-13 = E1-05 [Maximum Output Voltage]*.
- When *E1-13 = 0.0*, use the value of *E1-05* to control the voltage.

◆ E2: Motor 1 Parameters

E2 parameters [Motor 1 Parameters] set induction motor data. To switch drive operation from one motor to another motor, configure the first motor (motor 1).

12.6 E: Motor Parameters

If you cannot do Auto-Tuning, set the *E2-xx parameters* manually. Performing Auto-Tuning automatically sets the *E2 parameters* to the optimal values.

Note:

If *A1-02 [Control Method Selection]* is set to the following control modes, the keypad does not display *E2-xx*.

- 5 [PM Open Loop Vector]
- 6 [PM Advanced Open Loop Vector]
- 7 [PM Closed Loop Vector]
- 8 [EZ Vector Control]

■ E2-01: Motor Rated Current (FLA)

No. (Hex.)	Name	Description	Default (Range)
E2-01 (030E)	Motor Rated Current (FLA)	<div style="display: flex; justify-content: space-between; font-size: small;"> V/f CL-V/f OLV CLV AOLV OLV/PM AOLV/PM CLV/PM EZOLV </div> <p>Sets the motor rated current in amps.</p>	Determined by o2-04, C6-01 (10% to 200% of the drive rated current)

Note:

- If *E2-01 < E2-03 [Motor No-Load Current]*, the drive will detect *oPE02 [Parameter Range Setting Error]*.
- When the drive model changes, the display units for this parameter also change.
 - 0.01 A: models 2004 - 2042, 4002 - 4023
 - 0.1 A: models 2056 - 2415, 4031 - 4H12

The value set for *E2-01* becomes the reference value for motor protection, the torque limit, and torque control. Enter the motor rated current written on the motor nameplate. Auto-Tuning the drive will automatically set *E2-01* to the value input for “Motor Rated Current”.

■ E2-02: Motor Rated Slip

No. (Hex.)	Name	Description	Default (Range)
E2-02 (030F)	Motor Rated Slip	<div style="display: flex; justify-content: space-between; font-size: small;"> V/f CL-V/f OLV CLV AOLV OLV/PM AOLV/PM CLV/PM EZOLV </div> <p>Sets motor rated slip.</p>	Determined by o2-04, C6-01 (0.000 - 20.000 Hz)

This parameter value becomes the base slip compensation value. The drive automatically sets this parameter during Auto-Tuning. When you cannot do Auto-Tuning, calculate the motor rated slip with the information on the motor nameplate and this formula:

$$E2-02 = f - (n \times p) / 120$$

- f: Motor rated frequency (Hz)
- n: Rated motor speed (min⁻¹ (r/min))
- p: Number of motor poles

■ E2-03: Motor No-Load Current

No. (Hex.)	Name	Description	Default (Range)
E2-03 (0310)	Motor No-Load Current	<div style="display: flex; justify-content: space-between; font-size: small;"> V/f CL-V/f OLV CLV AOLV OLV/PM AOLV/PM CLV/PM EZOLV </div> <p>Sets the no-load current for the motor in amps when operating at the rated frequency and the no-load voltage.</p>	Determined by o2-04, C6-01 (0 to E2-01)

Note:

- When the drive model changes, the display units for this parameter also change.
 - 0.01 A: 2004 - 2042, 4002 - 4023
 - 0.1 A: 2056 - 2415, 4031 - 4H12

The drive automatically sets this parameter during Auto-Tuning. When you cannot do Auto-Tuning, you can also use the motor no-load current on the motor test report to enter this value manually. Get the test report from the motor manufacturer.

Note:

The default setting of the no-load current is for a 4-pole motor recommended by Yaskawa.

■ E2-04: Motor Pole Count

No. (Hex.)	Name	Description	Default (Range)
E2-04 (0311)	Motor Pole Count	<input type="checkbox"/> V/f <input type="checkbox"/> CL-V/f <input type="checkbox"/> OLV <input checked="" type="checkbox"/> CLV <input type="checkbox"/> AOLV <input type="checkbox"/> OLV/PM <input type="checkbox"/> AOLV/PM <input type="checkbox"/> CLV/PM <input type="checkbox"/> EZOLV Sets the number of motor poles.	4 (2 - 120)

Note:

- When $A1-02 = 0, 1, 3$ [Control Method Selection = V/f, CL-V/f, CLV], the maximum value is 120.
- When $A1-02 = 2, 4$ [OLV, AOLV], the maximum value is 48.

Auto-Tuning automatically sets this parameter to the value of [Number of Motor Poles].

■ E2-05: Motor Line-to-Line Resistance

No. (Hex.)	Name	Description	Default (Range)
E2-05 (0312)	Motor Line-to-Line Resistance	<input type="checkbox"/> V/f <input type="checkbox"/> CL-V/f <input type="checkbox"/> OLV <input checked="" type="checkbox"/> CLV <input type="checkbox"/> AOLV <input type="checkbox"/> OLV/PM <input type="checkbox"/> AOLV/PM <input type="checkbox"/> CLV/PM <input type="checkbox"/> EZOLV Sets the line-to-line resistance for the motor stator windings.	Determined by o2-04, C6-01 (0.000 - 65.000 Ω)

Note:

- This value is the motor line-to-line resistance. Do not set this parameter with the resistance per phase.
- On drive models 4810 to 4H12, the unit is mΩ, and the setting range is 0.000 mΩ to 65.000 mΩ.

Auto-Tuning automatically sets this parameter. If you cannot do Auto-Tuning, use the test report from the motor manufacturer to configure the settings. Use one of these formulas to calculate the motor line-to-line resistance:

- E-type insulation: [the resistance value (Ω) shown on the test report at 75 °C] × 0.822
- B-type insulation: [the resistance value (Ω) shown on the test report at 75 °C] × 0.822
- F-type insulation: [the resistance value (Ω) shown on the test report at 115 °C] × 0.728

■ E2-06: Motor Leakage Inductance

No. (Hex.)	Name	Description	Default (Range)
E2-06 (0313)	Motor Leakage Inductance	<input type="checkbox"/> V/f <input type="checkbox"/> CL-V/f <input type="checkbox"/> OLV <input checked="" type="checkbox"/> CLV <input type="checkbox"/> AOLV <input type="checkbox"/> OLV/PM <input type="checkbox"/> AOLV/PM <input type="checkbox"/> CLV/PM <input type="checkbox"/> EZOLV Sets the voltage drop from motor leakage inductance when the motor is operating at the rated frequency and rated current. This value is a percentage of Motor Rated Voltage.	Determined by o2-04, C6-01 (0.0 - 60.0%)

The drive automatically sets this parameter during Auto-Tuning.

Note:

The motor nameplate does not usually show the quantity of voltage drop. If you do not know the value of the motor leakage inductance, contact the motor manufacturer to receive a copy of the motor test report.

■ E2-07: Motor Saturation Coefficient 1

No. (Hex.)	Name	Description	Default (Range)
E2-07 (0314)	Motor Saturation Coefficient 1	<input type="checkbox"/> V/f <input type="checkbox"/> CL-V/f <input type="checkbox"/> OLV <input checked="" type="checkbox"/> CLV <input type="checkbox"/> AOLV <input type="checkbox"/> OLV/PM <input type="checkbox"/> AOLV/PM <input type="checkbox"/> CLV/PM <input type="checkbox"/> EZOLV Sets the motor iron-core saturation coefficient at 50% of the magnetic flux.	0.50 (0.00 - 0.50)

The drive uses this coefficient when it operates with constant output. The drive uses this coefficient when it operates the motor in the constant output range.

■ E2-08: Motor Saturation Coefficient 2

No. (Hex.)	Name	Description	Default (Range)
E2-08 (0315)	Motor Saturation Coefficient 2	<input type="checkbox"/> V/f <input type="checkbox"/> CL-V/f <input type="checkbox"/> OLV <input checked="" type="checkbox"/> CLV <input type="checkbox"/> AOLV <input type="checkbox"/> OLV/PM <input type="checkbox"/> AOLV/PM <input type="checkbox"/> CLV/PM <input type="checkbox"/> EZOLV Sets the motor iron-core saturation coefficient at 75% of the magnetic flux.	0.75 (E2-07 - 0.75)

The drive uses this coefficient when it operates with constant output. The drive uses this coefficient when it operates the motor in the constant output range.

■ **E2-09: Motor Mechanical Loss**

No. (Hex.)	Name	Description	Default (Range)
E2-09 (0316) Expert	Motor Mechanical Loss	V/f CL-V/f OLV CLV AOLV OLV/PM AOLV/PM CLV/PM EZOLV Sets the mechanical loss of the motor. It is set as a percentage of E2-11 [Motor Rated Power]. Usually it is not necessary to change this setting.	0.0% (0.0 - 10.0%)

Adjust this parameter in these conditions. The drive adds the configured mechanical loss to the torque reference value as a torque compensation value:

- There is a large quantity of torque loss from motor bearing friction.
- There is a large quantity of torque loss in fans and pumps.

■ **E2-10: Motor Iron Loss**

No. (Hex.)	Name	Description	Default (Range)
E2-10 (0317)	Motor Iron Loss	V/f CL-V/f OLV CLV AOLV OLV/PM AOLV/PM CLV/PM EZOLV Sets the motor iron loss.	Determined by o2-04, C6-01 (0 - 65535 W)

■ **E2-11: Motor Rated Power**

No. (Hex.)	Name	Description	Default (Range)
E2-11 (0318)	Motor Rated Power	V/f CL-V/f OLV CLV AOLV OLV/PM AOLV/PM CLV/PM EZOLV Sets the motor rated output in the units from o1-58 [Motor Power Unit Selection].	Determined by o2-04, C6-01 (0.00 - 1000.0)

Note:

On drive models 2xxx, and 4002 to 4675, the setting unit is 0.01 kW. The setting range is 0.00 kW to 650.00 kW (0.00 HP to 650.00 HP).

On drive models 4810 to 4H12, the setting unit is 0.1 kW. The setting range is 0.0 kW to 1000.0 kW (0.0 HP to 1340.5 HP).

The drive automatically sets this parameter to the value input for “Motor Rated Power” during Auto-Tuning.

◆ **E3: V/f Pattern for Motor 2**

E3 parameters [V/f Pattern for Motor 2] set the control mode and V/f pattern used for motor 2.

Note:

V/f preset patterns equivalent to those set with E1-03 [V/f Pattern Selection] are not available for E3 parameters. Use E3-04 [Motor 2 Maximum Output Frequency] to E3-10 [Motor 2 Minimum Output Voltage] to manually set the V/f pattern.

■ **Notes on Manually Setting V/f Patterns**

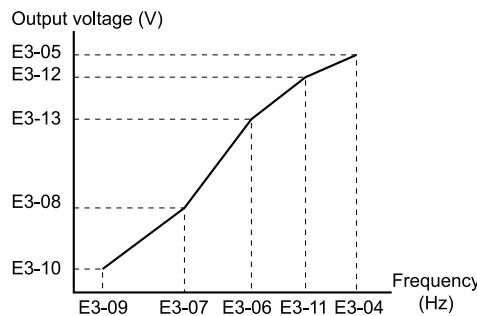

Figure 12.76 Motor 2 V/f Pattern Diagram

- To configure a linear V/f pattern at frequencies lower than E3-06 [Motor 2 Base Frequency], set E3-07 = E3-09 [Motor 2 Mid Point A Frequency = Motor 2 Minimum Output Frequency]. In this application, the drive ignores E1-08 [Mid Point A Voltage].
- Set the five frequencies as specified by these rules:
 $E3-09 \leq E3-07 < E3-06 \leq E3-11 \leq E3-04$ [Motor 2 Minimum Output Frequency ≤ Motor 2 Mid Point A Frequency < Motor 2 Base Frequency ≤ Motor 2 Mid Point B Frequency ≤ Motor 2 Maximum Output Frequency]
 Incorrect settings will trigger oPE10 [V/f Data Setting Error].

- If $E3-11 = 0.0$ Hz, the drive will ignore the V/f pattern settings.
- When you use *A1-03 [Initialize Parameters]* to initialize the drive, the drive will reset the manually set values for *E3-04 to E3-13 [Motor 2 Base Voltage]* to default values.

■ E3-01: Motor 2 Control Mode Selection

No. (Hex.)	Name	Description	Default (Range)
E3-01 (0319)	Motor 2 Control Mode Selection	V/f CL-V/f OLV CLV AOLV OLV/PM AOLV/PM CLV/PM EZOLV Sets the control method for motor 2.	0 (0 - 3)

Note:

- When you change this setting, the drive will set all parameters that are dependent on this parameter to their default settings.
- Parameter *L1-01 [Motor Overload (oL1) Protection]* sets the protection operation of *oL1 [Motor Overload]* the same as Motor 1.
- When you use parameter *A1-03 [Initialize Parameters]* to initialize the drive, this parameter is not reset.

0 : V/f Control

1 : V/f Control with Encoder

2 : Open Loop Vector

3 : Closed Loop Vector

■ E3-04: Motor 2 Maximum Output Frequency

No. (Hex.)	Name	Description	Default (Range)
E3-04 (031A)	Motor 2 Maximum Output Frequency	V/f CL-V/f OLV CLV AOLV OLV/PM AOLV/PM CLV/PM EZOLV Set the maximum output frequency for the motor 2 V/f pattern.	Determined by E3-01 (40.0 - 590.0 Hz)

■ E3-05: Motor 2 Maximum Output Voltage

No. (Hex.)	Name	Description	Default (Range)
E3-05 (031B)	Motor 2 Maximum Output Voltage	V/f CL-V/f OLV CLV AOLV OLV/PM AOLV/PM CLV/PM EZOLV Sets the maximum output voltage for the motor 2 V/f pattern.	Determined by E3-01 (200 V Class: 0.0 - 255.0 V, 400 V Class: 0.0 - 510.0 V)

■ E3-06: Motor 2 Base Frequency

No. (Hex.)	Name	Description	Default (Range)
E3-06 (031C)	Motor 2 Base Frequency	V/f CL-V/f OLV CLV AOLV OLV/PM AOLV/PM CLV/PM EZOLV Sets the base frequency for the motor 2 V/f pattern.	Determined by E3-01 (0.0 - E3-04)

■ E3-07: Motor 2 Mid Point A Frequency

No. (Hex.)	Name	Description	Default (Range)
E3-07 (031D)	Motor 2 Mid Point A Frequency	V/f CL-V/f OLV CLV AOLV OLV/PM AOLV/PM CLV/PM EZOLV Sets a middle output frequency for the motor 2 V/f pattern.	Determined by E3-01 (0.0 - E3-04)

■ E3-08: Motor 2 Mid Point A Voltage

No. (Hex.)	Name	Description	Default (Range)
E3-08 (031E)	Motor 2 Mid Point A Voltage	V/f CL-V/f OLV CLV AOLV OLV/PM AOLV/PM CLV/PM EZOLV Sets a middle output voltage for the motor 2 V/f pattern.	Determined by E3-01 (200 V Class: 0.0 - 255.0 V, 400 V Class: 0.0 - 510.0 V)

■ E3-09: Motor 2 Minimum Output Frequency

No. (Hex.)	Name	Description	Default (Range)
E3-09 (031F)	Motor 2 Minimum Output Frequency	V/f CL-V/f OLV CLV AOLV OLV/PM AOLV/PM CLV/PM EZOLV Sets the minimum output frequency for the motor 2 V/f pattern.	Determined by E3-01 (0.0 - E3-04)

■ **E3-10: Motor 2 Minimum Output Voltage**

No. (Hex.)	Name	Description	Default (Range)
E3-10 (0320)	Motor 2 Minimum Output Voltage	V/f CL-V/f OLV CLV AOLV OLV/PM AOLV/PM CLV/PM EZOLV Sets the minimum output voltage for the motor 2 V/f pattern.	Determined by E3-01 (200 V Class: 0.0 - 255.0 V, 400 V Class: 0.0 - 510.0 V)

■ **E3-11: Motor 2 Mid Point B Frequency**

No. (Hex.)	Name	Description	Default (Range)
E3-11 (0345) Expert	Motor 2 Mid Point B Frequency	V/f CL-V/f OLV CLV AOLV OLV/PM AOLV/PM CLV/PM EZOLV Sets a middle output frequency for the motor 2 V/f pattern. Set this parameter to adjust the V/f pattern for the constant output range. Usually it is not necessary to change this parameter.	0.0 Hz (0.0 - E3-04)

Note:

- Set this parameter to 0.0 to disable the function.
- When you initialize the drive, this parameter is reset to the default value.

■ **E3-12: Motor 2 Mid Point B Voltage**

No. (Hex.)	Name	Description	Default (Range)
E3-12 (0346) Expert	Motor 2 Mid Point B Voltage	V/f CL-V/f OLV CLV AOLV OLV/PM AOLV/PM CLV/PM EZOLV Sets a middle output voltage for the motor 2 V/f pattern. Set this parameter to adjust the V/f pattern for the constant output range. Usually it is not necessary to change this parameter.	0.0 V (200 V Class: 0.0 to 255.0 V, 400 V Class: 0.0 to 510.0 V)

Note:

- Set this parameter to 0.0 to disable the function.
- When you initialize the drive, this parameter is reset to the default value.
- The setting value changes automatically when you do Auto-Tuning (rotational and stationary 1 or 2).

■ **E3-13: Motor 2 Base Voltage**

No. (Hex.)	Name	Description	Default (Range)
E3-13 (0347) Expert	Motor 2 Base Voltage	V/f CL-V/f OLV CLV AOLV OLV/PM AOLV/PM CLV/PM EZOLV Sets the base voltage for the motor 2 V/f pattern. Set this parameter to adjust the V/f pattern for the constant output range. Usually it is not necessary to change this parameter.	0.0 V (200 V Class: 0.0 to 255.0 V, 400 V Class: 0.0 to 510.0 V)

Note:

- When you initialize the drive, this parameter is reset to the default value.
- The setting value changes automatically when you do Auto-Tuning (rotational and stationary 1 or 2).

◆ **E4: Motor 2 Parameters**

E4 parameters [Motor 2 Parameters] set induction motor data. To switch drive operation from one motor to a different motor, configure motor 2.

Auto-Tuning automatically sets the *E4 parameters* to the best values for the application. If you cannot do Auto-Tuning, set the *E4 parameters* manually.

Note:

E3-xx and *E4-xx* are available when *H1-xx* = 16 [*MFDI Function Select* = Motor 2 Selection].

■ **E4-01: Motor 2 Rated Current**

No. (Hex.)	Name	Description	Default (Range)
E4-01 (0321)	Motor 2 Rated Current	V/f CL-V/f OLV CLV AOLV OLV/PM AOLV/PM CLV/PM EZOLV Sets the motor rated current for motor 2 in amps.	Determined by o2-04, C6-01 (10% to 200% of the drive rated current)

Note:

- If $E4-01 \leq E4-03$ [Motor 2 Rated No-Load Current], the drive will detect $oPE02$ [Parameter Range Setting Error].
- When the drive model changes, the display units for this parameter also change.
 - 0.01 A: 2004 - 2042, 4002 - 4023
 - 0.1 A: 2056 - 2415, 4031 - 4H12

The value set for $E4-01$ becomes the reference value for motor protection, the torque limit, and torque control. Enter the motor rated current written on the motor nameplate. Auto-Tuning automatically sets the value of $E4-01$ to the value input for [Motor Rated Current].

■ E4-02: Motor 2 Rated Slip

No. (Hex.)	Name	Description	Default (Range)
E4-02 (0322)	Motor 2 Rated Slip	<div style="display: flex; justify-content: space-between; font-size: 0.8em;"> V/f CL-V/f OLV CLV AOLV OLV/PM AOLV/PM CLV/PM EZOLV </div> Sets the motor rated slip for motor 2.	Determined by o2-04, C6-01 (0.000 - 20.000 Hz)

The value set in $E4-02$ becomes the base slip compensation value. The drive sets this parameter during Rotational Auto-Tuning and Stationary Auto-Tuning. If you cannot do Auto-Tuning, use the information written on the motor nameplate and this formula to calculate the motor rated slip:

$$E4-02 = f - (n \times p) / 120$$

- f: Motor rated frequency (Hz)
- n: Rated motor speed (min^{-1} (r/min))
- p: Number of motor poles

■ E4-03: Motor 2 Rated No-Load Current

No. (Hex.)	Name	Description	Default (Range)
E4-03 (0323)	Motor 2 Rated No-Load Current	<div style="display: flex; justify-content: space-between; font-size: 0.8em;"> V/f CL-V/f OLV CLV AOLV OLV/PM AOLV/PM CLV/PM EZOLV </div> Sets the no-load current for motor 2 in amps when operating at the rated frequency and the no-load voltage.	Determined by o2-04, C6-01 (Less than 0 - E4-01)

Note:

The display units are different for different models:

- 0.01 A: 2004 - 2042, 4002 - 4023
- 0.1 A: 2056 - 2415, 4031 - 4H12

You can also manually enter the motor no-load current shown on the motor test report to $E4-03$. Contact the motor manufacturer for the motor test report.

Note:

The default setting of the no-load current is for a 4-pole motor recommended by Yaskawa.

■ E4-04: Motor 2 Motor Poles

No. (Hex.)	Name	Description	Default (Range)
E4-04 (0324)	Motor 2 Motor Poles	<div style="display: flex; justify-content: space-between; font-size: 0.8em;"> V/f CL-V/f OLV CLV AOLV OLV/PM AOLV/PM CLV/PM EZOLV </div> Sets the number of poles for motor 2.	4 (2 - 120)

Auto-Tuning automatically sets $E4-04$ to the value input for [Number of Motor Poles].

■ E4-05: Motor 2 Line-to-Line Resistance

No. (Hex.)	Name	Description	Default (Range)
E4-05 (0325)	Motor 2 Line-to-Line Resistance	<div style="display: flex; justify-content: space-between; font-size: 0.8em;"> V/f CL-V/f OLV CLV AOLV OLV/PM AOLV/PM CLV/PM EZOLV </div> Sets the line-to-line resistance for the motor 2 stator windings.	Determined by o2-04, C6-01 (0.000 - 65.000 Ω)

Note:

- This value is the motor line-to-line resistance. Do not set this parameter with the resistance per phase.
- On drive models 4810 to 4H12, the unit is m Ω , and the setting range is 0.000 m Ω to 65.000 m Ω .

Auto-Tuning automatically sets this parameter. If you cannot do Auto-Tuning, use the test report from the motor manufacturer to configure the settings. To calculate the motor line-to-line resistance, use the information shown on the motor nameplate with one of these formulas:

- E-type insulation: [the resistance value (Ω) shown on the test report at 75 °C] \times 0.822
- B-type insulation: [the resistance value (Ω) shown on the test report at 75 °C] \times 0.822
- F-type insulation: [the resistance value (Ω) shown on the test report at 115 °C] \times 0.728

■ **E4-06: Motor 2 Leakage Inductance**

No. (Hex.)	Name	Description	Default (Range)
E4-06 (0326)	Motor 2 Leakage Inductance	<div style="display: flex; justify-content: space-between; font-size: 0.8em;"> V/f CL-V/f OLV CLV AOLV OLV/PM AOLV/PM CLV/PM EZOLV </div> <p>Sets the voltage drop from motor 2 leakage inductance as a percentage of Motor Rated Voltage when motor 2 operates at the rated frequency and rated current.</p>	Determined by o2-04, C6-01 (0.0 - 60.0%)

The drive sets this parameter during Rotational Auto-Tuning and Stationary Auto-Tuning.

Note:

You cannot usually find the quantity of voltage drop on the motor nameplate. If you do not know the value of the motor 2 leakage inductance, get the test report from the motor manufacturer.

■ **E4-07: Motor 2 Saturation Coefficient 1**

No. (Hex.)	Name	Description	Default (Range)
E4-07 (0343)	Motor 2 Saturation Coefficient 1	<div style="display: flex; justify-content: space-between; font-size: 0.8em;"> V/f CL-V/f OLV CLV AOLV OLV/PM AOLV/PM CLV/PM EZOLV </div> <p>Sets the motor 2 iron-core saturation coefficient at 50% of the magnetic flux.</p>	0.50 (0.00 - 0.50)

The drive sets this parameter during Rotational Auto-Tuning. The drive uses this value when it operates the motor in the constant output range.

■ **E4-08: Motor 2 Saturation Coefficient 2**

No. (Hex.)	Name	Description	Default (Range)
E4-08 (0344)	Motor 2 Saturation Coefficient 2	<div style="display: flex; justify-content: space-between; font-size: 0.8em;"> V/f CL-V/f OLV CLV AOLV OLV/PM AOLV/PM CLV/PM EZOLV </div> <p>Sets the motor 2 iron-core saturation coefficient at 75% of the magnetic flux.</p>	0.75 (E4-07 - 0.75)

The drive sets this parameter during Rotational Auto-Tuning. The drive uses this value when it operates the motor in the constant output range.

■ **E4-09: Motor 2 Mechanical Loss**

No. (Hex.)	Name	Description	Default (Range)
E4-09 (033F) Expert	Motor 2 Mechanical Loss	<div style="display: flex; justify-content: space-between; font-size: 0.8em;"> V/f CL-V/f OLV CLV AOLV OLV/PM AOLV/PM CLV/PM EZOLV </div> <p>Sets the mechanical loss of motor 2. It is set as a percentage of E4-11 [Motor 2 Rated Power]. Usually it is not necessary to change this setting.</p>	0.0% (0.0 - 10.0%)

Adjust this parameter in these conditions. The drive adds the configured mechanical loss to the torque reference value as a torque compensation value:

- There is a large quantity of torque loss from motor bearing friction.
- There is a large quantity of torque loss in fans and pumps.

■ **E4-10: Motor 2 Iron Loss**

No. (Hex.)	Name	Description	Default (Range)
E4-10 (0340)	Motor 2 Iron Loss	<div style="display: flex; justify-content: space-between; font-size: 0.8em;"> V/f CL-V/f OLV CLV AOLV OLV/PM AOLV/PM CLV/PM EZOLV </div> <p>Sets the motor iron loss for motor 2.</p>	Determined by o2-04, C6-01 (0 - 65535 W)

■ **E4-11: Motor 2 Rated Power**

No. (Hex.)	Name	Description	Default (Range)
E4-11 (0327)	Motor 2 Rated Power	<div style="display: flex; justify-content: space-between; font-size: 0.8em;"> V/f CL-V/f OLV CLV AOLV OLV/PM AOLV/PM CLV/PM EZOLV </div> <p>Sets the motor rated output in the units from o1-58 [Motor Power Unit Selection].</p>	Determined by o2-04, C6-01 (0.00 - 1000.0)

Note:

On drive models 2xxx, and 4002 to 4675, the setting unit is 0.01 kW. The setting range is 0.00 kW to 650.00 kW (0.00 HP to 650.00 HP).

On drive models 4810 to 4H12, the setting unit is 0.1 kW. The setting range is 0.0 kW to 1000.0 kW (0.0 HP to 1340.5 HP).

Auto-Tuning automatically sets this parameter to the value input for [Motor Rated Power].

◆ E5: PM Motor Settings

E5 parameters are used to set PM motor data.

Set *E5-01* to the motor code when using PM motors recommended by Yaskawa. *E5* and other related motor parameters will be automatically set to the optimal values.

Perform Auto-Tuning for all other PM motors. If information from motor nameplates or test reports is available, the *E5 parameters* can be manually entered.

Note:

- The keypad displays *E5-xx* only when *A1-02* = 5, 6, 7 [Control Method Selection = OLV/PM, AOLV/PM, CLV/PM].
- *E5-xx parameters* are not reset when the drive is initialized using parameter *A1-03* [Initialize Parameters].

■ E5-01: PM Motor Code Selection

No. (Hex.)	Name	Description	Default (Range)
E5-01 (0329)	PM Motor Code Selection	<div style="display: flex; justify-content: space-between; font-size: small;"> V/f CL-V/f OLV CLV AOLV OLV/PM AOLV/PM CLV/PM EZOLV </div> <p>Sets the motor code for Yaskawa PM motors. The drive uses the motor code to automatically set some parameters to their correct settings.</p>	FFFF (0000 - FFFF)

Note:

If the drive hunts or shows an alarm after you enter a motor code, use the keypad to enter the value shown on the nameplate to *E5-xx*.

■ E5-02: PM Motor Rated Power (kW)

No. (Hex.)	Name	Description	Default (Range)
E5-02 (032A)	PM Motor Rated Power	<div style="display: flex; justify-content: space-between; font-size: small;"> V/f CL-V/f OLV CLV AOLV OLV/PM AOLV/PM CLV/PM EZOLV </div> <p>Sets the PM motor rated output in the units from <i>o1-58</i> [Motor Power Unit Selection].</p>	Determined by E5-01 (0.10 - 1000.0)

Note:

On drive models 2xxx, and 4002 to 4675, the setting unit is 0.01 kW. The setting range is 0.10 kW to 650.00 kW (0.10 HP to 650.00 HP).

On drive models 4810 to 4H12, the setting unit is 0.1 kW. The setting range is 0.1 kW to 1000.0 kW (0.1 HP to 1340.5 HP).

These Auto-Tuning methods will automatically set this parameter:

- Manual Entry w/ Motor Data Sheet
- PM Stationary Auto-Tuning
- Rotational (Ld, Lq, R, back-EMF)

■ E5-03: PM Motor Rated Current (FLA)

No. (Hex.)	Name	Description	Default (Range)
E5-03 (032B)	Motor Rated Current (FLA)	<div style="display: flex; justify-content: space-between; font-size: small;"> V/f CL-V/f OLV CLV AOLV OLV/PM AOLV/PM CLV/PM EZOLV </div> <p>Sets the PM motor rated current (FLA).</p>	Determined by E5-01 (10% to 200% of the drive rated current)

Note:

The display units are different for different models:

- 0.01 A: models 2004 - 2042, 4002 - 4023
- 0.1 A: models 2056 - 2415, 4031 - 4H12

The drive automatically sets *E5-03* to the value input for “PM Motor Rated Current” after you do these types of Auto-Tuning:

- Manual Entry w/ Motor Data Sheet
- PM Stationary Auto-Tuning
- Stationary (R Only)
- Rotational (Ld, Lq, R, back-EMF)

■ **E5-04: PM Motor Pole Count**

No. (Hex.)	Name	Description	Default (Range)
E5-04 (032C)	PM Motor Pole Count	<div style="display: flex; justify-content: space-between; font-size: 0.8em;"> V/f CL-V/f OLV CLV AOLV OLV/PM AOLV/PM CLV/PM EZOLV </div> Sets the number of PM motor poles.	Determined by E5-01 (2 - 120)

Note:

- When $A1-02 = 7$ [Control Method Selection = CLV/PM], the maximum value is 120.
- When $A1-02 = 5, 6$ or 8 [OLV/PM, AOLV/PM or EZOLV], the maximum value is 48.

These types of Auto-Tuning will automatically set this parameter to the value of [Number of Motor Poles]:

- Manual Entry w/ Motor Data Sheet
- PM Stationary Auto-Tuning
- Rotational (Ld, Lq, R, back-EMF)

■ **E5-05: PM Motor Resistance (ohms/phase)**

No. (Hex.)	Name	Description	Default (Range)
E5-05 (032D)	PM Motor Resistance (ohms/phase)	<div style="display: flex; justify-content: space-between; font-size: 0.8em;"> V/f CL-V/f OLV CLV AOLV OLV/PM AOLV/PM CLV/PM EZOLV </div> Sets the resistance per phase of a PM motor. Set 50% of the line-to-line resistance.	0.100 Ω (0.000 - 65.000 Ω)

PM motor Auto-Tuning automatically sets this parameter to the value of [PM Motor Stator Resistance].

Note:

- Do not change the setting calculated by Auto-Tuning unless it is necessary.
- On drive models 4810 to 4H12, the unit is mΩ, and the setting range is 0.000 mΩ to 65.000 mΩ.

■ **E5-06: PM d-axis Inductance (mH/phase)**

No. (Hex.)	Name	Description	Default (Range)
E5-06 (032E)	PM d-axis Inductance (mH/phase)	<div style="display: flex; justify-content: space-between; font-size: 0.8em;"> V/f CL-V/f OLV CLV AOLV OLV/PM AOLV/PM CLV/PM EZOLV </div> Sets the PM motor d-axis inductance.	1.00 mH (0.00 - 300.00 mH)

PM motor Auto-Tuning automatically sets this parameter to the value of [PM Motor d-Axis Inductance].

Note:

Do not change the setting calculated by Auto-Tuning unless it is necessary.

■ **E5-07: PM q-axis Inductance (mH/phase)**

No. (Hex.)	Name	Description	Default (Range)
E5-07 (032F)	PM q-axis Inductance (mH/phase)	<div style="display: flex; justify-content: space-between; font-size: 0.8em;"> V/f CL-V/f OLV CLV AOLV OLV/PM AOLV/PM CLV/PM EZOLV </div> Sets the PM motor q-axis inductance.	1.00 mH (0.00 - 600.00 mH)

PM motor Auto-Tuning automatically sets this parameter to the value of [PM Motor q-Axis Inductance].

Note:

Do not change the setting calculated by Auto-Tuning unless it is necessary.

■ **E5-09: PM Back-EMF Vpeak (mV/(rad/s))**

No. (Hex.)	Name	Description	Default (Range)
E5-09 (0331)	PM Back-EMF Vpeak (mV/(rad/s))	<div style="display: flex; justify-content: space-between; font-size: 0.8em;"> V/f CL-V/f OLV CLV AOLV OLV/PM AOLV/PM CLV/PM EZOLV </div> Sets the peak value of PM motor induced voltage.	0.0 mV/(rad/sec) (0.0 - 2000.0 mV/(rad/s))

Set this parameter when you use an IPM motor with derated torque or an IPM motor with constant torque.

PM motor Auto-Tuning automatically sets this parameter to the value of [Back-EMF Voltage Constant (Ke)].

When $E5-01 = FFFF$, only set $E5-09$ or $E5-24$ [PM Back-EMF L-L V_{rms} (mV/rpm)] as the induced voltage constant.

Note:

When you set this parameter, also set $E5-24 = 0.0$. The drive will detect $oPE08$ [Parameter Selection Error] in these conditions:

- $E5-09 = 0.0$ and $E5-24 = 0.0$
- $E5-09 \neq 0.0$ and $E5-24 \neq 0.0$

■ E5-11: Encoder Z-Pulse Offset

No. (Hex.)	Name	Description	Default (Range)
E5-11 (0333)	Encoder Z-Pulse Offset	V/f CL-V/f OLV CLV AOLV OLV/PM AOLV/PM CLV/PM EZOLV Sets the encoder Z-pulse offset.	0.0 degrees (-180.0 - +180.0 degrees)

The drive uses the PM motor parameter settings and PM Stationary Auto-Tuning to set *E5-11* to the value input for “Encoder Z-Pulse Offset” automatically. The drive uses Z Pulse Offset Tuning or the Rotational Auto-Tuning to set *E5-11*.

■ E5-24: PM Back-EMF L-L Vrms (mV/rpm)

No. (Hex.)	Name	Description	Default (Range)
E5-24 (0353)	PM Back-EMF L-L Vrms (mV/rpm)	V/f CL-V/f OLV CLV AOLV OLV/PM AOLV/PM CLV/PM EZOLV Sets the RMS value for PM motor line voltage.	200 V Class: 100.0 mV/min ⁻¹ 400 V Class: 200.0 mV/min ⁻¹ (0.0 - 6500.0 mV/min ⁻¹)

Set this parameter when you use an SPM motor.

PM motor Auto-Tuning automatically sets this parameter to the value of [Back-EMF Voltage Constant (Ke)].

When *E5-01* = FFFF, only set *E5-09* [PM Back-EMF V_{peak} (mV/(rad/s))] or *E5-24* as the induced voltage constant.

Note:

When you set this parameter, also set *E5-09* = 0.0. The drive will detect *oPE08* [Parameter Selection Error] in these conditions:

- *E5-09* = 0.0 and *E5-24* = 0.0
- *E5-09* ≠ 0.0 and *E5-24* ≠ 0.0

■ E5-25: Polarity Estimation Timeout

No. (Hex.)	Name	Description	Default (Range)
E5-25 (035E) Expert	Polarity Estimation Timeout	V/f CL-V/f OLV CLV AOLV OLV/PM AOLV/PM CLV/PM EZOLV Sets the function that switches polarity for initial polarity estimation. Usually it is not necessary to change this setting.	0 (0, 1)

0 : Disabled

1 : Enabled

◆ E9: Motor Setting

E9 parameters are used to configure induction motors, PM motors, and SynRM motors. Configure these parameters only for derating torque applications in which a high level of responsiveness and accurate speed control are not required.

E9 parameters are automatically configured with values input by the Auto-Tuning process for motor parameter settings. *E9 parameters* can be manually configured when the EZ Tuning process cannot be performed.

■ E9-01: Motor Type Selection

No. (Hex.)	Name	Description	Default (Range)
E9-01 (11E4)	Motor Type Selection	V/f CL-V/f OLV CLV AOLV OLV/PM AOLV/PM CLV/PM EZOLV Sets the type of motor.	0 (0 - 2)

EZ Tuning automatically sets this parameter to the value of [Motor Type Selection].

0 : Induction (IM)

1 : Permanent Magnet (PM)

2 : Synchronous Reluctance (SynRM)

■ E9-02: Maximum Speed

No. (Hex.)	Name	Description	Default (Range)
E9-02 (11E5)	Maximum Speed	<div style="display: flex; justify-content: space-between; font-size: 0.8em;"> V/f CL-V/f OLV CLV AOLV OLV/PM AOLV/PM CLV/PM EZOLV </div> Sets the maximum speed of the motor.	Determined by E9-01 (40.0 - 120.0 Hz)

Note:

The unit of measure changes when the setting of *o1-04 [V/f Pattern Display Unit]*.

EZ Tuning automatically sets this parameter to the value of [Motor Max Revolutions].

■ E9-03: Rated Speed

No. (Hex.)	Name	Description	Default (Range)
E9-03 (11E6)	Rated Speed	<div style="display: flex; justify-content: space-between; font-size: 0.8em;"> V/f CL-V/f OLV CLV AOLV OLV/PM AOLV/PM CLV/PM EZOLV </div> Sets the rated rotation speed of the motor.	Determined by E9-01 (100 - 7200 min ⁻¹)

EZ Tuning automatically sets this parameter to the value of [Rated Speed].

Note:

Set *E9-01 = 0 [Motor Type Selection = Induction (IM)]* before you set this parameter.

■ E9-04: Base Frequency

No. (Hex.)	Name	Description	Default (Range)
E9-04 (11E7)	Base Frequency	<div style="display: flex; justify-content: space-between; font-size: 0.8em;"> V/f CL-V/f OLV CLV AOLV OLV/PM AOLV/PM CLV/PM EZOLV </div> Sets the rated frequency of the motor.	Determined by E9-01 (40.0 - 120.0 Hz)

Note:

The unit of measure changes when the setting of *o1-04 [V/f Pattern Display Unit]*.

EZ Tuning automatically sets this parameter to the value of [Base Frequency].

■ E9-05: Base Voltage

No. (Hex.)	Name	Description	Default (Range)
E9-05 (11E8)	Motor Rated Voltage	<div style="display: flex; justify-content: space-between; font-size: 0.8em;"> V/f CL-V/f OLV CLV AOLV OLV/PM AOLV/PM CLV/PM EZOLV </div> Sets the rated voltage of the motor.	200 V Class: 200.0 V, 400 V Class: 400.0 V (200 V Class: 0.0 - 255.0 V, 400 V Class: 0.0 - 510.0 V)

EZ Tuning automatically sets this parameter to the value of [Base Voltage].

■ E9-06: Motor Rated Current (FLA)

No. (Hex.)	Name	Description	Default (Range)
E9-06 (11E9)	Motor Rated Current (FLA)	<div style="display: flex; justify-content: space-between; font-size: 0.8em;"> V/f CL-V/f OLV CLV AOLV OLV/PM AOLV/PM CLV/PM EZOLV </div> Sets the motor rated current in amps.	Determined by E9-01 and o2-04 (10% to 200% of the drive rated current)

Note:

The display units are different for different models:

- 0.01 A: models 2004 - 2042, 4002 - 4023
- 0.1 A: models 2056 - 2415, 4031 - 4H12

The setting value of *E9-06* is the reference value for motor protection. Enter the motor rated current written on the motor nameplate. Auto-Tuning the drive will automatically set *E9-06* to the value input for “Motor Rated Current”.

■ E9-07: PM Motor Rated Power (kW)

No. (Hex.)	Name	Description	Default (Range)
E9-07 (11EA)	PM Motor Rated Power	<div style="display: flex; justify-content: space-between; font-size: 0.8em;"> V/f CL-V/f OLV CLV AOLV OLV/PM AOLV/PM CLV/PM EZOLV </div> Sets the motor rated output in the units from <i>o1-58 [Motor Power Unit Selection]</i> .	Determined by E9-02 and o2-04 (0.00 - 1000.0)

Note:

On drive models 2xxx, and 4002 to 4675, the setting unit is 0.01 kW. The setting range is 0.00 kW to 650.00 kW (0.00 HP to 650.00 HP).

On drive models 4810 to 4H12, the setting unit is 0.1 kW. The setting range is 0.0 kW to 1000.0 kW (0.0 HP to 1340.5 HP).

Auto-Tuning automatically sets this parameter to the value of [Motor Rated Power (kW)].

■ E9-08: Motor Pole Count

No. (Hex.)	Name	Description	Default (Range)
E9-08 (11EB)	Motor Pole Count	V/f CL-V/f OLV CLV AOLV OLV/PM AOLV/PM CLV/PM EZOLV Sets the number of motor poles.	4 (2 to 120)

Auto-Tuning automatically sets this parameter to the value of [Number of Motor Poles].

■ E9-09: Motor Rated Slip

No. (Hex.)	Name	Description	Default (Range)
E9-09 (11EC)	Motor Rated Slip	V/f CL-V/f OLV CLV AOLV OLV/PM AOLV/PM CLV/PM EZOLV Sets the motor rated slip.	0.000 Hz (0.000 - 20.000 Hz)

The setting value of this parameter is the slip compensation reference value.

The drive uses the setting values of *E9-03*, *E9-04*, and *E9-08* to calculate this parameter. When Motor Rated Slip = 0, Auto-Tuning automatically sets this parameter to the value of [Motor Rated Slip].

Note:

Set *E9-01* = 0 [Motor Type Selection = Induction (IM)] before you set this parameter.

■ E9-10: Motor Line-to-Line Resistance

No. (Hex.)	Name	Description	Default (Range)
E9-10 (11ED)	Motor Line-to-Line Resistance	V/f CL-V/f OLV CLV AOLV OLV/PM AOLV/PM CLV/PM EZOLV Sets the line-to-line resistance for the motor stator windings.	Determined by o2-04 (0.000 - 65.000 Ω)

Note:

- This value is the motor line-to-line resistance. Do not set this parameter with the resistance per phase.
- On drive models 4810 to 4H12, the unit is mΩ, and the setting range is 0.000 mΩ to 65.000 mΩ.

Stationary Auto-Tuning automatically sets this parameter. If you cannot do Stationary Auto-Tuning, use the test report from the motor manufacturer. Use one of these formulas to calculate the motor line-to-line resistance:

- E-type insulation: [the resistance value (Ω) shown on the test report at 75 °C] × 0.822
- B-type insulation: [the resistance value (Ω) shown on the test report at 75 °C] × 0.822
- F-type insulation: [the resistance value (Ω) shown on the test report at 115 °C] × 0.728

12.7 F: Options

F parameters are used to set option cards, which function as interfaces for encoders, analog I/O, digital I/O, and fieldbus communication.

◆ F1: Encoder Option Setup

F1 parameters set the operation of and protective function for the encoder option. Table 12.48 lists the setting parameters available for each option.

Refer to the instruction manual packaged with the encoder option for more information on how to install, wire, and set the encoder options.

WARNING! Sudden Movement Hazard. Do test runs and examine the drive to make sure that the command references are correct. If you set the command reference incorrectly, it can cause damage to the drive or serious injury or death.

WARNING! Sudden Movement Hazard. Make sure that the host controller circuitry has correct safety design that will let you keep control of the motor if the drive loses speed feedback. If you do not have control of the motor, it can cause serious injury or death.

Table 12.48 Encoder Option Setting Parameters

Setting Parameter	Encoder Option			
	PG-B3	PG-X3	PG-F3	PG-RT3
F1-01	x	x	x	-
F1-02	x	x	x	x
F1-03	x	x	x	x
F1-04	x	x	x	x
F1-05	x	x	x	x
F1-06	x	x	x	-
F1-08	x	x	x	x
F1-09	x	x	x	x
F1-10	x	x	x	x
F1-11	x	x	x	x
F1-12 *1	x	x	-	-
F1-13 *1	x	x	-	-
F1-14	x	x	x	x
F1-18	x	x	x	x
F1-19	x	x	x	x
F1-20	-	x	x	-
F1-21	x	x	-	-
F1-30	x	x	-	-
F1-31 *2 *3	x	x	-	-
F1-32 *2 *3	x	x	-	-
F1-33 *1 *2	x	x	-	-
F1-34 *1 *2	x	x	-	-
F1-35 *2 *3	x	x	-	-
F1-36 *3	-	x	-	-
F1-37 *2 *3	x	x	-	-
F1-50	-	-	x	-
F1-51	-	-	x	-
F1-52	-	-	x	-
Number of options that you can install in a drive	2	2	1	1

*1 Parameters set when $A1-02 = 1$ [CL-V/f].

*2 Parameters to set an option connected to CN5-B. The drive recognizes the PG option installed to CN5-B as PG2.

- *3 When $A1-02 = 3, 7$ [Control Method Selection = CLV, CLV/PM], you can set the parameters for PG2 without setting $H1-xx = 16$ [Terminal Sx Function Selection = Motor 2 Selection].

The drive recognizes the PG option installed to CN5-B as PG2. You can use it as a function block (PG CH2, PGP ZP CH2) in DriveWorksEZ. These are the restrictions:

- Install the PG option for motor control (PG1) to CN5-C.
- The drive detects hardware disconnection of CN5-C (PG1) and CN5-B (PG2), but does not detect Z-phase disconnection of CN5-B (PG2).
- Do not set $H1-xx = 16$. When $H1-xx = 16$, PG2 acts as a motor speed detector.

■ F1-01: Encoder 1 Pulse Count (PPR)

No. (Hex.)	Name	Description	Default (Range)
F1-01 (0380)	Encoder 1 Pulse Count (PPR)	V/f <input type="checkbox"/> CL-V/f <input type="checkbox"/> OLV <input type="checkbox"/> CLV <input type="checkbox"/> AOLV <input type="checkbox"/> OLV/PM <input type="checkbox"/> AOLV/PM <input type="checkbox"/> CLV/PM <input type="checkbox"/> EZOLV <input type="checkbox"/> Sets the number of output pulses for each motor revolution.	1024 ppr (1 - 60000 ppr)

■ F1-02: Encoder Signal Loss Detect Sel

No. (Hex.)	Name	Description	Default (Range)
F1-02 (0381)	Encoder Signal Loss Detect Sel	V/f <input type="checkbox"/> CL-V/f <input type="checkbox"/> OLV <input type="checkbox"/> CLV <input type="checkbox"/> AOLV <input type="checkbox"/> OLV/PM <input type="checkbox"/> AOLV/PM <input type="checkbox"/> CLV/PM <input type="checkbox"/> EZOLV <input type="checkbox"/> Sets the method to stop the motor or let the motor continue operating when the drive detects <i>PGO</i> [Encoder (PG) Feedback Loss].	1 (0 - 4)

If the drive does not detect output pulses from the encoder for the time set in *F1-14* [Encoder Open-Circuit Detect Time], it will trigger *PGO*.

Note:

- Motor speed and load conditions can cause *ov* [Overvoltage] and *oC* [Overcurrent] faults.
- In AOLV control, set $n4-72 = 1$ [Speed Feedback Mode = With Encoder].

0 : Ramp to Stop

The drive ramps the motor to stop in the deceleration time. Fault relay output terminal MA-MC turns ON, and MB-MC turns OFF.

1 : Coast to Stop

The output turns off and the motor coasts to stop. Fault relay output terminal MA-MC turns ON, and MB-MC turns OFF.

2 : Fast Stop (Use C1-09)

The drive stops the motor in the deceleration time set in *C1-09* [Fast Stop Time]. Fault relay output terminal MA-MC turns ON, and MB-MC turns OFF.

3 : Alarm Only

The keypad shows *PGO* and the drive continues operation. Only use this setting in special conditions to prevent damage to the motor and machinery. The output terminal set for *Alarm* [*H2-01 to H2-03 = 10*] activates.

4 : No Alarm Display

The drive continues operation and does not show *PGO* on the keypad. Only use this setting in special conditions to prevent damage to the motor and machinery.

■ F1-03: Overspeed Detection Selection

No. (Hex.)	Name	Description	Default (Range)
F1-03 (0382)	Overspeed Detection Selection	V/f <input type="checkbox"/> CL-V/f <input type="checkbox"/> OLV <input type="checkbox"/> CLV <input type="checkbox"/> AOLV <input type="checkbox"/> OLV/PM <input type="checkbox"/> AOLV/PM <input type="checkbox"/> CLV/PM <input type="checkbox"/> EZOLV <input type="checkbox"/> Sets the method to stop the motor or let the motor continue operating when the drive detects <i>oS</i> [Overspeed].	1 (0 - 3)

When the motor speed is more than the value set in *F1-08* [Overspeed Detection Level] for longer than the time set in *F1-09* [Overspeed Detection Delay Time], the drive will detect *oS*.

0 : Ramp to Stop

The drive ramps the motor to stop in the deceleration time. Fault relay output terminal MA-MC turns ON, and MB-MC turns OFF.

1 : Coast to Stop

The output turns off and the motor coasts to stop. Fault relay output terminal MA-MC turns ON, and MB-MC turns OFF.

2 : Fast Stop (Use C1-09)

The drive stops the motor in the deceleration time set in *C1-09 [Fast Stop Time]*. Fault relay output terminal MA-MC turns ON, and MB-MC turns OFF.

3 : Alarm Only

The keypad shows *oS* and the drive continues operation. Only use this setting in special conditions to prevent damage to the motor and machinery. The output terminal set for *Alarm [H2-01 to H2-03 = 10]* activates.

Note:

When *A1-02 = 6 [Control Method Selection = AOLV/PM]*, the drive will automatically set *F1-03 = 1 [Coast to Stop]*. You cannot change this value.

■ F1-04: Speed Deviation Detection Select

No. (Hex.)	Name	Description	Default (Range)
F1-04 (0383)	Speed Deviation Detection Select	<input type="checkbox"/> V/f <input checked="" type="checkbox"/> CL-V/f <input type="checkbox"/> OLV <input checked="" type="checkbox"/> CLV <input checked="" type="checkbox"/> AOLV <input type="checkbox"/> OLV/PM <input type="checkbox"/> AOLV/PM <input type="checkbox"/> CLV/PM <input type="checkbox"/> EZOLV Sets the method to stop the motor or let the motor continue operating when the drive detects <i>dEv</i> [<i>Speed Deviation</i>].	3 (0 - 3)

When the difference between the frequency reference and the motor speed is more than the value set in *F1-10 [Speed Deviation Detection Level]* for longer than the time set in *F1-11 [Speed Deviation Detect DelayTime]*, the drive will detect *dEv*.

0 : Ramp to Stop

The drive ramps the motor to stop in the deceleration time. Fault relay output terminal MA-MC turns ON, and MB-MC turns OFF.

1 : Coast to Stop

The output turns off and the motor coasts to stop. Fault relay output terminal MA-MC turns ON, and MB-MC turns OFF.

2 : Fast Stop (Use C1-09)

The drive stops the motor in the deceleration time set in *C1-09 [Fast Stop Time]*. Fault relay output terminal MA-MC turns ON, and MB-MC turns OFF.

3 : Alarm Only

The keypad shows *dEv* and the drive continues operation. Only use this setting in special conditions to prevent damage to the motor and machinery. The output terminal set for *Alarm [H2-01 to H2-03 = 10]* activates.

■ F1-05: Encoder 1 Rotation Selection

No. (Hex.)	Name	Description	Default (Range)
F1-05 (0384)	Encoder 1 Rotation Selection	<input type="checkbox"/> V/f <input checked="" type="checkbox"/> CL-V/f <input type="checkbox"/> OLV <input checked="" type="checkbox"/> CLV <input checked="" type="checkbox"/> AOLV <input type="checkbox"/> OLV/PM <input type="checkbox"/> AOLV/PM <input type="checkbox"/> CLV/PM <input type="checkbox"/> EZOLV Sets the output sequence for the A and B pulses from the encoder, assuming that the motor is operating in the forward direction.	Determined by A1-02 (0, 1)

Refer to the option card installation manual for more information about how to set the encoder pulse output sequence and make sure that it is correct.

0 : Pulse A leads in FWD Direction

1 : Pulse B leads in FWD Direction

■ F1-06: Encoder 1 Pulse Monitor Scaling

No. (Hex.)	Name	Description	Default (Range)
F1-06 (0385)	Encoder 1 Pulse Monitor Scaling	<input type="checkbox"/> V/f <input checked="" type="checkbox"/> CL-V/f <input type="checkbox"/> OLV <input checked="" type="checkbox"/> CLV <input checked="" type="checkbox"/> AOLV <input type="checkbox"/> OLV/PM <input type="checkbox"/> AOLV/PM <input type="checkbox"/> CLV/PM <input type="checkbox"/> EZOLV Sets the ratio between the pulse input and the pulse output of the encoder as a 3-digit number. The first digit is the numerator and the second and third digits set the denominator.	001 (001 - 032, 102 - 132 (1 - 1/32))

When the setting value is a 3-digit value (xyz), the dividing ratio is $(1 + x)/yz$

For example, when *F1-06 = 032*, the dividing ratio is 1/32.

Note:

When you use a single-pulse encoder, the dividing ratio for the monitor signal is 1:1

■ F1-08: Overspeed Detection Level

No. (Hex.)	Name	Description	Default (Range)
F1-08 (0387)	Overspeed Detection Level	<div style="display: flex; justify-content: space-between; align-items: center;"> V/f CL-V/f OLV CLV AOLV OLV/PM AOLV/PM CLV/PM EZOLV </div> Sets the detection level of ωS [Overspeed] as a percentage when the maximum output frequency is 100%.	115% (0 - 120%)

When the motor speed is more than the value set in *F1-08* for longer than the time set in *F1-09* [Overspeed Detection Delay Time], the drive will detect ωS .

■ F1-09: Overspeed Detection Delay Time

No. (Hex.)	Name	Description	Default (Range)
F1-09 (0388)	Overspeed Detection Delay Time	<div style="display: flex; justify-content: space-between; align-items: center;"> V/f CL-V/f OLV CLV AOLV OLV/PM AOLV/PM CLV/PM EZOLV </div> Sets the length of time that the speed feedback must be more than the <i>F1-08</i> level to cause ωS [Overspeed].	Determined by A1-02 (0.0 - 2.0 s)

When the motor speed is more than the value set in *F1-08* [Overspeed Detection Level] for longer than the time set in *F1-09*, the drive will detect ωS .

■ F1-10: Speed Deviation Detection Level

No. (Hex.)	Name	Description	Default (Range)
F1-10 (0389)	Speed Deviation Detection Level	<div style="display: flex; justify-content: space-between; align-items: center;"> V/f CL-V/f OLV CLV AOLV OLV/PM AOLV/PM CLV/PM EZOLV </div> Sets the detection level of dEv [Speed Deviation] as a percentage when the maximum output frequency is 100%.	10% (0 - 50%)

When the speed deviation between the frequency reference and the actual motor speed is more than the value set in *F1-10* for longer than the time set in *F1-11* [Speed Deviation Detect DelayTime], the drive will detect dEv .

■ F1-11: Speed Deviation Detect DelayTime

No. (Hex.)	Name	Description	Default (Range)
F1-11 (038A)	Speed Deviation Detect DelayTime	<div style="display: flex; justify-content: space-between; align-items: center;"> V/f CL-V/f OLV CLV AOLV OLV/PM AOLV/PM CLV/PM EZOLV </div> Sets the length of time that the difference between the frequency reference and speed feedback must be more than the level in <i>F1-10</i> to cause dEv [Speed Deviation].	0.5 s (0.0 - 10.0 s)

When the speed deviation between the frequency reference and the actual motor speed is more than the value set in *F1-10* [Speed Deviation Detection Level] for longer than the time set in *F1-11*, the drive will detect dEv .

■ F1-12: Encoder 1 Gear Teeth 1

No. (Hex.)	Name	Description	Default (Range)
F1-12 (038B)	Encoder 1 Gear Teeth 1	<div style="display: flex; justify-content: space-between; align-items: center;"> V/f CL-V/f OLV CLV AOLV OLV/PM AOLV/PM CLV/PM EZOLV </div> Sets the number of gear teeth on the motor side. This parameter and <i>F1-13</i> [Encoder 1 Gear Teeth 2] set the gear ratio between the motor and encoder.	0 (0 - 1000)

After you set the number of gear teeth, the drive uses this formula to calculate the motor speed:

$$\text{Motor speed (min}^{-1} \text{ or r/min)} = \frac{\text{Number of pulses from the encoder} \times 60}{F1-01} \times \frac{F1-13}{F1-12}$$

Note:

When *F1-12* = 0 or *F1-13* = 0, the gear ratio is 1.

■ F1-13: Encoder 1 Gear Teeth 2

No. (Hex.)	Name	Description	Default (Range)
F1-13 (038C)	Encoder 2 Gear Teeth 1	<div style="display: flex; justify-content: space-between; align-items: center;"> V/f CL-V/f OLV CLV AOLV OLV/PM AOLV/PM CLV/PM EZOLV </div> Sets the number of gear teeth on the load side. This parameter and <i>F1-12</i> [Encoder 1 Gear Teeth 1] set the gear ratio between the motor and encoder.	0 (0 - 1000)

After you set the number of gear teeth, the drive uses this formula to calculate the motor speed:

$$\text{Motor speed (min}^{-1} \text{ or r/min)} = \frac{\text{Number of pulses from the encoder} \times 60}{F1-01} \times \frac{F1-13}{F1-12}$$

Note:

When $F1-12 = 0$ or $F1-13 = 0$, the gear ratio is 1.

■ **F1-14: Encoder Open-Circuit Detect Time**

No. (Hex.)	Name	Description	Default (Range)
F1-14 (038D)	Encoder Open-Circuit Detect Time	<div style="display: flex; justify-content: space-between; font-size: small;"> V/f CL-V/f OLV CLV AOLV OLV/PM AOLV/PM CLV/PM EZOLV </div> <p>Sets the length of time that the drive must not receive a pulse signal to cause <i>PGo</i> [Encoder (PG) Feedback Loss].</p>	2.0 s (0.0 - 10.0 s)

If the drive does not detect output pulses from the encoder for longer than the time set in *F1-14*, the drive will detect *PGo*.

Note:

Motor speed and load conditions can cause *ov* [Overvoltage] and *oC* [Overcurrent] faults.

■ **F1-16: Deviation 1 Detection Selection**

No. (Hex.)	Name	Description	Default (Range)
F1-16 (03AB) Expert	Deviation 1 Detection Selection	<div style="display: flex; justify-content: space-between; font-size: small;"> V/f CL-V/f OLV CLV AOLV OLV/PM AOLV/PM CLV/PM EZOLV </div> <p>Sets the function that enables and disables Deviation 1 Detection Selection. When $A1-02 = 7$ [Control Method Selection = CLV/PM], this function is always enabled.</p>	0 (0, 1)

Closed Loop Vector Control (CLV) does not use the Z phase for motor control. When it is necessary to monitor the motor position and you are using the Z phase pulse signal in a host controller, enable it for protection.

■ **F1-17: Deviation 2 Detection Selection**

No. (Hex.)	Name	Description	Default (Range)
F1-17 (03AC)	Deviation 2 Detection Selection	<div style="display: flex; justify-content: space-between; font-size: small;"> V/f CL-V/f OLV CLV AOLV OLV/PM AOLV/PM CLV/PM EZOLV </div> <p>Usually it is not necessary to change this setting. Sets the number of motor rotations that the drive will detect more than one Z pulse per rotation to detect <i>dv2</i>.</p>	10 (0 - 100)

When $F1-17 = 0$, the drive will not detect *dv2*.

■ **F1-18: Deviation 3 Detection Selection**

No. (Hex.)	Name	Description	Default (Range)
F1-18 (03AD)	Deviation 3 Detection Selection	<div style="display: flex; justify-content: space-between; font-size: small;"> V/f CL-V/f OLV CLV AOLV OLV/PM AOLV/PM CLV/PM EZOLV </div> <p>Sets the number of rotations necessary to detect conditions that invert the torque reference and rate of acceleration and cause <i>dv3</i> [Inversion Detection].</p>	10 (0 - 10)

When the drive detects these two conditions at the same time for the number of times set in *F1-18*, the drive will detect *dv3*.

- The torque reference and acceleration are in opposite directions. For example, torque reference is in forward run and the acceleration is in a negative direction.
- The difference between the speed reference and the actual motor speed is more than 30%.

Note:

- Reference the setting value for *E5-11* [Encoder Z-Pulse Offset] and the $\delta\theta$ value found on the motor nameplate. A usual cause for a *dv3* fault is an incorrect *E5-11* setting.
- Set $F1-18 = 0$ to disable the function.

■ **F1-19: Deviation 4 Detection Selection**

No. (Hex.)	Name	Description	Default (Range)
F1-19 (03AE)	Deviation 4 Detection Selection	<div style="display: flex; justify-content: space-between; font-size: small;"> V/f CL-V/f OLV CLV AOLV OLV/PM AOLV/PM CLV/PM EZOLV </div> <p>Sets the number of pulses necessary to cause <i>dv4</i> [Inversion Prevention Detection].</p>	128 (0 - 5000)

The drive detects a *dv4* [Inversion Prevention Detection] fault when the pulses in a reverse direction to the speed reference are input for longer than the time set in *F1-19*.

Note:

- Refer to the *E5-11 [Encoder Z-Pulse Offset]* value and the $\Delta\theta$ value shown on the motor nameplate. An incorrect *E5-11* value will frequently be the cause of a *dv4* fault.
- When you use the drive in an application that rotates the motor from the load side in the reverse direction of the speed reference, set *F1-19* = 0.

■ F1-20: Encoder 1 PCB Disconnect Detect

No. (Hex.)	Name	Description	Default (Range)
F1-20 (03B4)	Encoder 1 PCB Disconnect Detect	V/f <input type="checkbox"/> CL-V/f <input checked="" type="checkbox"/> OLV <input type="checkbox"/> CLV <input type="checkbox"/> AOLV <input type="checkbox"/> OLV/PM <input type="checkbox"/> AOLV/PM <input type="checkbox"/> CLV/PM <input type="checkbox"/> EZOLV <input type="checkbox"/> Sets the function that enables and disables detection of a disconnected encoder connection cable to cause <i>PGoH [Encoder (PG) Hardware Fault]</i> .	1 (0, 1)

0 : Disabled

1 : Enabled

■ F1-21: Encoder 1 Signal Selection

No. (Hex.)	Name	Description	Default (Range)
F1-21 (03BC)	Encoder 1 Signal Selection	V/f <input type="checkbox"/> CL-V/f <input checked="" type="checkbox"/> OLV <input type="checkbox"/> CLV <input type="checkbox"/> AOLV <input type="checkbox"/> OLV/PM <input type="checkbox"/> AOLV/PM <input type="checkbox"/> CLV/PM <input type="checkbox"/> EZOLV <input type="checkbox"/> Sets the number of channels for the signal to the encoder option card.	0 (0, 1)

0 : A Pulse Detection

1 : AB Pulse Detection

■ F1-30: Motor 2 Encoder PCB Port Select

No. (Hex.)	Name	Description	Default (Range)
F1-30 (03AA)	Motor 2 Encoder PCB Port Select	V/f <input type="checkbox"/> CL-V/f <input type="checkbox"/> OLV <input checked="" type="checkbox"/> CLV <input type="checkbox"/> AOLV <input type="checkbox"/> OLV/PM <input type="checkbox"/> AOLV/PM <input type="checkbox"/> CLV/PM <input type="checkbox"/> EZOLV <input type="checkbox"/> Sets the drive port to install the motor 2 encoder option card.	1 (0, 1)

0 : CN5-C

One option card receives the speed feedback signals from motor 1 and motor 2.

1 : CN5-B

Two option cards receive the speed feedback signals from motor 1 and motor 2.

■ F1-31: Encoder 2 Pulse Count (PPR)

No. (Hex.)	Name	Description	Default (Range)
F1-31 (03B0)	Encoder 2 Pulse Count (PPR)	V/f <input type="checkbox"/> CL-V/f <input type="checkbox"/> OLV <input checked="" type="checkbox"/> CLV <input type="checkbox"/> AOLV <input type="checkbox"/> OLV/PM <input type="checkbox"/> AOLV/PM <input type="checkbox"/> CLV/PM <input type="checkbox"/> EZOLV <input type="checkbox"/> Sets the number of output pulses for each motor revolution for motor 2.	1024 ppr (1 - 60000 ppr)

Note:

When *A1-02* = 3, 7 [*Control Method Selection* = *CLV, CLV/PM*], you can set the number of output pulses without setting *H1-xx* = 16 [*Motor 2 Selection*].

■ F1-32: Encoder 2 Rotation Selection

No. (Hex.)	Name	Description	Default (Range)
F1-32 (03B1)	Encoder 2 Rotation Selection	V/f <input type="checkbox"/> CL-V/f <input type="checkbox"/> OLV <input checked="" type="checkbox"/> CLV <input type="checkbox"/> AOLV <input type="checkbox"/> OLV/PM <input type="checkbox"/> AOLV/PM <input type="checkbox"/> CLV/PM <input type="checkbox"/> EZOLV <input type="checkbox"/> Sets the output sequence for the A and B pulses from the encoder for motor 2. This parameter assumes that the motor is operating in the forward direction.	0 (0, 1)

Refer to the option instruction manual for more information about how to set the encoder pulse output sequence and make sure that it is correct.

Note:

When *A1-02* = 3, 7 [*Control Method Selection* = *CLV, CLV/PM*], you can set this parameter without setting *H1-xx* = 16 [*Motor 2 Selection*].

0 : Pulse A leads in FWD Direction

1 : Pulse B leads in FWD Direction

■ F1-33: Encoder 2 Gear Teeth 1

No. (Hex.)	Name	Description	Default (Range)
F1-33 (03B2)	Encoder 2 Gear Teeth 1	<div style="display: flex; justify-content: space-between; font-size: 0.8em;"> V/f CL-V/f OLV CLV AOLV OLV/PM AOLV/PM CLV/PM EZOLV </div> <p>Sets the number of gear teeth on the motor side for motor 2. This parameter and <i>F1-34 [Encoder 2 Gear Teeth 2]</i> set the gear ratio between the motor and encoder.</p>	0 (0 - 1000)

After you set the number of gear teeth, the drive uses this formula to calculate the motor speed:

$$\text{Motor speed (min}^{-1} \text{ or r/min)} = \frac{\text{Number of pulses from the encoder} \times 60}{F1-31} \times \frac{F1-33}{F1-34}$$

Note:

When *F1-33 = 0* or *F1-34 = 0*, the gear ratio is 1.

■ F1-34: Encoder 2 Gear Teeth 2

No. (Hex.)	Name	Description	Default (Range)
F1-34 (03B3)	Encoder 2 Gear Teeth 2	<div style="display: flex; justify-content: space-between; font-size: 0.8em;"> V/f CL-V/f OLV CLV AOLV OLV/PM AOLV/PM CLV/PM EZOLV </div> <p>Sets the number of gear teeth on the load side for motor 2. This parameter and <i>F1-33 [Encoder 2 Gear Teeth 1]</i> set the gear ratio between the motor and encoder.</p>	0 (0 - 1000)

After you set the number of gear teeth, the drive uses this formula to calculate the motor speed:

$$\text{Motor speed (min}^{-1} \text{ or r/min)} = \frac{\text{Number of pulses from the encoder} \times 60}{F1-31} \times \frac{F1-33 \text{ (load-side PG gear teeth)}}{F1-34 \text{ (motor-side PG gear teeth)}}$$

Note:

When *F1-33 = 0* or *F1-34 = 0*, the gear ratio is 1.

■ F1-35: Encoder 2 Pulse Monitor Scaling

No. (Hex.)	Name	Description	Default (Range)
F1-35 (03BE)	Encoder 2 Pulse Monitor Scaling	<div style="display: flex; justify-content: space-between; font-size: 0.8em;"> V/f CL-V/f OLV CLV AOLV OLV/PM AOLV/PM CLV/PM EZOLV </div> <p>Sets the ratio between the pulse input and the pulse output of the encoder as a 3-digit number for motor 2. The first digit is the numerator and the second and third digits are the denominator.</p>	001 (001 - 032, 102 - 132 (1 - 1/32))

Note:

When *A1-02 = 3, 7 [Control Method Selection = CLV, CLV/PM]*, you can set this parameter without setting *H1-xx = 16 [Motor 2 Selection]*.

When the setting value is a 3-digit value (xyz), the dividing ratio is (1 + x)/yz.

For example, when *F1-35 = 032*, the dividing ratio is 1/32.

Note:

For a single-pulse encoder, the dividing ratio for the monitor signal is 1:1.

■ F1-36: Encoder 2 PCB Disconnect Detect

No. (Hex.)	Name	Description	Default (Range)
F1-36 (03B5)	Encoder 2 PCB Disconnect Detect	<div style="display: flex; justify-content: space-between; font-size: 0.8em;"> V/f CL-V/f OLV CLV AOLV OLV/PM AOLV/PM CLV/PM EZOLV </div> <p>Sets the function that enables and disables detection of a disconnected encoder connection cable that causes <i>PGoH [Encoder (PG) Hardware Fault]</i> for motor 2.</p>	1 (0, 1)

Note:

When *A1-02 = 3, 7 [Control Method Selection = CLV, CLV/PM]*, you can set this parameter without setting *H1-xx = 16 [Motor 2 Selection]*.

0 : Disabled

1 : Enabled

■ F1-37: Encoder 2 Signal Selection

No. (Hex.)	Name	Description	Default (Range)
F1-37 (03BD)	Encoder 2 Signal Selection	<div style="display: flex; justify-content: space-between; font-size: 0.8em;"> V/f CL-V/f OLV CLV AOLV OLV/PM AOLV/PM CLV/PM EZOLV </div> <p>Sets the number of channels for the signal to the encoder option for motor 2.</p>	0 (0, 1)

Note:

When $F1-02 = 3, 7$ [Control Method Selection = CLV, CLV/PM], you can set this parameter without setting $F1-xx = 16$ [Motor 2 Selection].

0 : A Pulse Detection**1 : AB Pulse Detection****■ F1-46: dv2 Detection Method Selection**

No. (Hex.)	Name	Description	Default (Range)
F1-46 (1B98)	dv2 Detection Method Selection	<div style="display: flex; justify-content: space-between; align-items: center;"> V/f CL-V/f OLV CLV AOLV OLV/PM AOLV/PM CLV/PM EZOLV </div> <p>Usually it is not necessary to change this setting. Sets the detection method for <i>dv2</i> [Z Pulse Noise Fault Detection].</p>	0 (0, 1)

To detect *dv2* while a multi-pole motor (for example 24 or more poles) is running at zero speed, set $F1-46 = 1$ [MechanicalAngle Detection Method].

0 : ElectricalAngle Detection Method**1 : MechanicalAngle Detection Method****■ F1-47: Deviation 2 Detection Selection**

No. (Hex.)	Name	Description	Default (Range)
F1-47 (1B99)	Deviation 2 Detection Selection	<div style="display: flex; justify-content: space-between; align-items: center;"> V/f CL-V/f OLV CLV AOLV OLV/PM AOLV/PM CLV/PM EZOLV </div> <p>Usually it is not necessary to change this setting. Sets the sensitivity of detection for <i>dv2</i> [Z Pulse Noise Fault Detection]. Increase the value to decrease the sensitivity.</p>	15° (0 - 180°)

These $F1-46$ [dv2 Detection Method Selection] settings change the setting units of $F1-47$:

- $F1-46 = 0$: $F1-47$ uses electric angles (deg)
- $F1-46 = 1$: $F1-47$ uses mechanical angles (one motor rotation is equivalent to a mechanical angle of 360 degrees)

■ F1-50: PG-F3 Option Encoder Type

No. (Hex.)	Name	Description	Default (Range)
F1-50 (03D2)	PG-F3 Option Encoder Type	<div style="display: flex; justify-content: space-between; align-items: center;"> V/f CL-V/f OLV CLV AOLV OLV/PM AOLV/PM CLV/PM EZOLV </div> <p>Sets the type of encoder connected to the PG-F3 option.</p>	0 (0 - 2)

0 : EnDat Sin/Cos**1 : EnDat Serial Only****2 : HIPERFACE****■ F1-51: PG-F3 PGoH Detection Level**

No. (Hex.)	Name	Description	Default (Range)
F1-51 (03D3)	PG-F3 PGoH Detection Level	<div style="display: flex; justify-content: space-between; align-items: center;"> V/f CL-V/f OLV CLV AOLV OLV/PM AOLV/PM CLV/PM EZOLV </div> <p>The drive will detect PGoH [Encoder (PG) Hardware Fault] if the value of this parameter is smaller than the value of $\sqrt{\sin^2\theta + \cos^2\theta}$.</p>	80% (1 - 100%)

The drive will detect PGoH if the value of this parameter is smaller than the value of $\sqrt{\sin^2\theta + \cos^2\theta}$.

Regarding the expression $\sqrt{\sin^2\theta + \cos^2\theta}$, Sin θ is the single-track (phase B) output from the encoder and Cos θ is the single-track (phase A) output from the encoder.

Note:

This function is enabled when $F1-20 = 1$ [Encoder 1 PCB Disconnect Detect = Enabled].

■ F1-52: Serial Encoder Comm Speed

No. (Hex.)	Name	Description	Default (Range)
F1-52 (03D4)	Serial Encoder Comm Speed	<div style="display: flex; justify-content: space-between; align-items: center;"> V/f CL-V/f OLV CLV AOLV OLV/PM AOLV/PM CLV/PM EZOLV </div> <p>Sets the communication speed between the PG-F3 option and the serial encoder.</p>	0 (0 - 2)

Note:

This function is enabled when $F1-50 = 1$ or 2 [$PG-F3$ Option Encoder Type = EnDat Serial Only or HIPERFACE].

0 : 1M/9600bps

1 : 500k/19200bps

2 : 1M/38400bps

◆ **F2: Analog Input Option**

F2 parameters set the operation of the drive when you use analog input option card AI-A3. The AI-A3 card has 3 input terminals that accept voltages of -10 V to +10 V (20 kΩ) or currents of 4 mA to 20 mA (250 Ω). Install the AI-A3 card to enable setting very accurate analog references with high resolution.

Refer to the AI-A3 option manual for more information about how to install, wire, and set the AI-A3 card.

WARNING! Sudden Movement Hazard. Do test runs and examine the drive to make sure that the command references are correct. If you set the command reference incorrectly, it can cause damage to the drive or serious injury or death.

■ **F2-01: Analog Input Function Selection**

No. (Hex.)	Name	Description	Default (Range)
F2-01 (038F)	Analog Input Function Selection	<div style="display: flex; justify-content: space-around; font-size: small;"> V/f CL-V/f OLV CLV AOLV OLV/PM AOLV/PM CLV/PM EZOLV </div> <p>Sets the input method for the analog reference used with AI-A3.</p>	0 (0, 1)

Note:

When the AI-A3 card is not mounted in the drive, analog input terminals A1 to A3 on the drive are always enabled. The setting of this parameter does not have an effect.

0 : 3 Independent Channels

Set $F2-01 = 0$ to increase the precision of A/D conversion when you use the functions for terminals A1 to A3 on the drive as they are. You can input the MFAI signal from terminals V1 through V3 for AI-A3. The functions for terminals A1, A2, and A3 on the drive are sent to terminals V1, V2, and V3 for AI-A3. Use gain and bias adjustment when you input current to set signals to have negative numbers.

Note:

- Set $b1-01 = 1$ [$Frequency Reference Selection 1 = Analog Input$] to set inputs individually.
- If $F2-01 = 0$ and $b1-01 = 3$ [$Option PCB$], the drive will detect $oPE05$ [$Run Cmd/Freq Ref Source Sel Err$].

Figure 12.77 shows the individual input of analog inputs. $H3-xx$ parameters set the function to input the analog reference received from the AI-A3 card and to adjust the gain and bias of these signals.

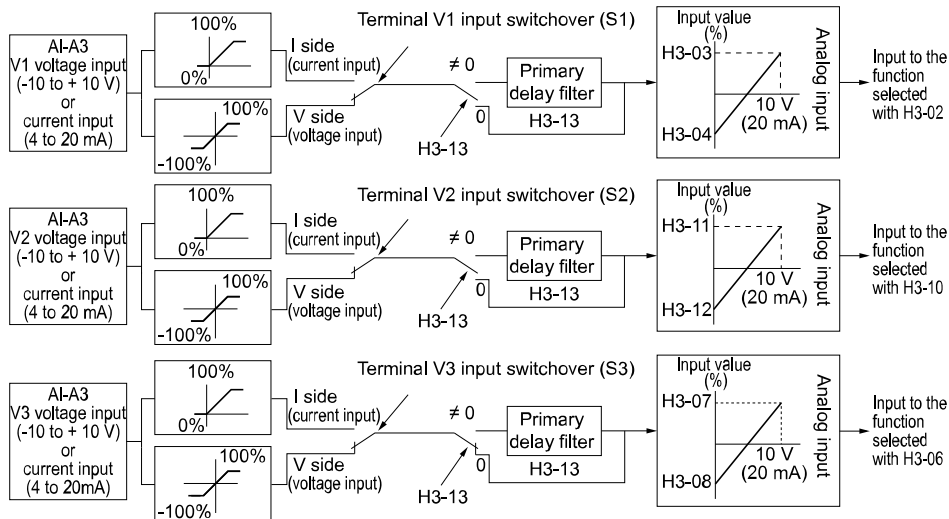

Figure 12.77 Analog Input Reference Individual Input Block Diagram

1 : 3 Channels Added Together

Set $b1-01 = 3$ [$Option PCB$] to set addition input.

You can input the frequency reference directly. The sum value when you add the input from terminals V1 to V3 becomes the frequency reference.

Set $F2-01 = 1$ to use the AI-A3 card as addition input.

Figure 12.78 shows addition input. Use *F2-02* [Analog Input Option Card Gain] and *F2-03* [Analog Input Option Card Bias] to adjust the analog reference gain and bias for addition input.

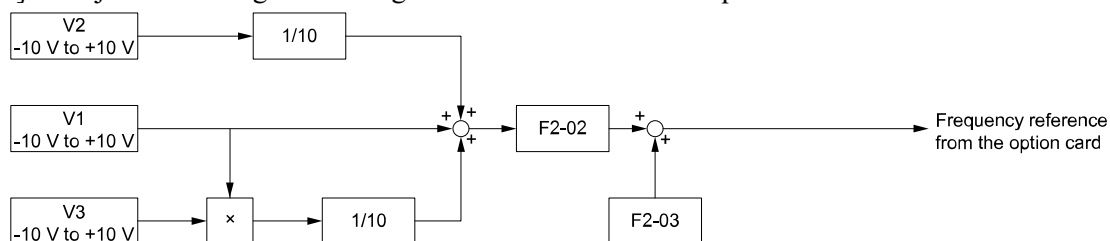

Figure 12.78 Analog Input Reference Addition Input Block Diagram

Use F2-02 and F2-03 to Adjust the Input Status

When the bias set in *F2-03* is 0%, the gain in *F2-02* and the addition input value set the ratio (%) of the maximum output frequency output as the frequency reference.

Note:

A voltage input of 10 V or a current input of 20 mA is the 100% value for each channel.

The bias set in *F2-03* sets the ratio (%) of the maximum output frequency output as the frequency reference when the addition input value is 0%.

Note:

A voltage input of 0 V or a current input of 4 mA is the 0% value for each channel.

• Example 1:

When the gain set in *F2-02* is 50%, the bias set in *F2-03* is 0%, and the addition input value is 100%, the frequency reference is 50% of the maximum output frequency. When the addition input value is 200%, the frequency reference is 100% of the maximum output frequency.

• Example 2:

When the gain set in *F2-02* is 200%, the bias set in *F2-03* is 0%, and the addition input value is 50%, the frequency reference is equivalent to the maximum output frequency. The frequency reference will not be more than the maximum output frequency, although the addition input value is 50% or higher.

• Example 3:

When the gain set in *F2-02* is 100%, the bias set in *F2-03* is 30%, and the addition input value is 0%, the frequency reference is 30% of the maximum output frequency. When the addition input value is 70%, the frequency reference will be equivalent to the maximum output frequency. The frequency reference will not be more than the maximum output frequency, although the addition input value is 70% or higher.

■ F2-02: Analog Input Option Card Gain

No. (Hex.)	Name	Description	Default (Range)
F2-02 (0368) RUN	Analog Input Option Card Gain	V/f CL-V/f OLV CLV AOLV OLV/PM AOLV/PM CLV/PM EZOLV Sets the analog reference gain as a percentage when the maximum output frequency is 100%.	100.0% (-999.9 - +999.9%)

Note:

Set *F2-01* = 1 [Analog Input Function Selection = 3 Channels Added Together] to enable this function.

■ F2-03: Analog Input Option Card Bias

No. (Hex.)	Name	Description	Default (Range)
F2-03 (0369) RUN	Analog Input Option Card Bias	V/f CL-V/f OLV CLV AOLV OLV/PM AOLV/PM CLV/PM EZOLV Sets the analog reference bias as a percentage when the maximum output frequency is 100%.	0.0% (-999.9 - +999.9%)

Note:

Set *F2-01* = 1 [Analog Input Function Selection = 3 Channels Added Together] to enable this function.

◆ F3: Digital Input Option

F3 parameters set the type of input signal to use with digital input option card DI-A3.

Use these digital inputs to set the frequency reference when you install the DI-A3 card in a drive. Set *b1-01* = 3 [Frequency Reference Selection 1 = Option PCB] to use this card as the frequency reference input. The input signal is isolated input of 24 Vdc and 8 mA.

- Binary, 16-bit/BCD, 4-digit input
- Binary, 12-bit/BCD, 3-digit input
- Binary, 8-bit/BCD, 2-digit input

You can also use the DI-A3 option as an MFDI, if the setting of *F3-01* is correct.

On drives with software versions PRG: 01031 and later that do not have a DI-A3 option installed, when you set *F3-01* = 8 [*Digital Input Function Selection = Multi-Function Digital Input*], it enables these functions:

- *H1-40* [*Mbus Reg 15C0h bit0 Input Func*] to *H1-42* [*Mbus Reg 15C0h bit2 Input Func*]
- *H7-01* to *H7-04* [*Virtual Multi-Function Input 1 to 4*]

WARNING! Sudden Movement Hazard. Do test runs and examine the drive to make sure that the command references are correct. If you set the command reference incorrectly, it can cause damage to the drive or serious injury or death.

■ MFDI for DI-A3

Set *F3-01* = 8 [*Digital Input Function Selection = Multi-Function Digital Input*] and *b1-01* ≠ 3 [*Frequency Reference Selection 1 ≠ Option PCB*] to use digital input option DI-A3 as an MFDI.

Use *F3-10* to *F3-25* [*Terminal D0 Function Selection to Terminal DF Function Selection*] to set the function for the DI-A3 terminals.

Note:

- Refer to *H1-xx* "Multi-function Digital Input Setting Values" for more information about MFDI setting values.
- Values 0 [*3-Wire Sequence*] and 20 to 2F [*External Fault*] for *F3-10* to *F3-25*.
- When you do not use DI-A3 as an MFDI, set *F3-10* to *F3-25* = F [*Not Used*].
- The drive reads DI-A3 terminal Dx two times as specified by parameter *b1-06* [*Digital Input Reading*].
- Configuring such that *F3-01* = 8 when DI-A3 is the frequency reference source (*b1-01* or *b1-15* = 3 [*Frequency Reference Selection 1/2 = Option PCB*]) results in the detection of *oPE05* [*Run Cmd/Freq Ref Source Sel Err*].
- You can use these functions with the DI-A3 MFDI:
 - H1-40* to *H1-42* [*Mbus Reg 15C0h bit0 to bit2 Input Func*]
 - H7-01* to *H7-04* [*Virtual Multi-Function Input 1 to 4*]

■ F3-01: Digital Input Function Selection

No. (Hex.)	Name	Description	Default (Range)
F3-01 (0390)	Digital Input Function Selection	<div style="display: flex; justify-content: space-between; font-size: small;"> V/f CL-V/f OLV CLV AOLV OLV/PM AOLV/PM CLV/PM EZOLV </div> <p>Sets the data format of digital input signals. This parameter is enabled when <i>o1-03</i> = 0 or 1 [<i>Frequency Display Unit Selection = 0.01 Hz or 0.01% (100% = E1-04)</i>].</p>	0 (0 - 8)

Note:

When *o1-03* = 2 [*min⁻¹ (r/min) unit*] or 3 [*User Units*], the input signal type is BCD. The *o1-03* value sets the setting units.

- 0 : BCD, 1% units**
- 1 : BCD, 0.1% units**
- 2 : BCD, 0.01% units**
- 3 : BCD, 1 Hz units**
- 4 : BCD, 0.1 Hz units**
- 5 : BCD, 0.01 Hz units**
- 6 : BCD (5-digit), 0.01 Hz**
- 7 : Binary input**

The setting unit and setting range are different for different values of *F3-03* [*Digital Input Data Length Select*].

- *F3-03* = 0 [*8-bit*]: 100%/255 (-255 to +255)
- *F3-03* = 1 [*12-bit*]: 100%/4095 (-4095 to +4095)
- *F3-03* = 2 [*16-bit*]: 100%/30000 (-33000 to +33000)

8 : Multi-Function Digital Input

The DI-A3 option is also used as a multi-function digital input terminal.

When the DI-A3 option is not installed in the drive and *F3-01* = 8, these functions are enabled:

- *H1-40* [*Mbus Reg 15C0h bit0 Input Func*] to *H1-42* [*Mbus Reg 15C0h bit2 Input Func*]
- *H7-01* to *H7-04* [*Virtual Multi-Function Input 1 to 4*]

F3-03: Digital Input Data Length Select

No. (Hex.)	Name	Description	Default (Range)
F3-03 (03B9)	Digital Input Data Length Select	V/f CL-V/f OLV CLV AOLV OLV/PM AOLV/PM CLV/PM EZOLV Sets the number of bits to set the frequency reference with DI-A3.	2 (0 - 2)

0 : 8-bit

1 : 12-bit

2 : 16-bit

Table 12.49 DI-A3 Terminal Function Selection

Terminal Block	Terminal Name	BCD, Signed [F3-01 = 0 to 5]				BCD, Unsigned [F3-01 = 6] ^{*1}		Binary, Signed [F3-01 = 7]				
		8-bit [F3-03 = 0]		12-bit [F3-03 = 1]		16-bit [F3-03 = 2]		8-bit [F3-03 = 0]	12-bit [F3-03 = 1]	16-bit [F3-03 = 2]		
TB2	D0	1 digit (0 - 9)	1	1 digit (0 - 9)	1	1 digit (0 - 9)	1	1 digit (0, 2, 4, 6, 8)	2	bit 0	bit 0	bit 0
	D1		2		2		4		bit 1	bit 1	bit 1	
	D2		4		4		8		bit 2	bit 2	bit 2	
	D3		8		8		8		2 digits (0 - 9)	1	bit 3	bit 3
	D4	2 digits (0 - 15) ^{*2}	1	2 digits (0 - 9)	1	2 digits (0 - 9)	1	3 digits (0 - 9)	2	bit 4	bit 4	bit 4
	D5		2		2		4		bit 5	bit 5	bit 5	
	D6		4		4		8		bit 6	bit 6	bit 6	
	D7		8		8		8		3 digits (0 - 9)	1	bit 7	bit 7
TB3	D8	-	-	3 digits (0 - 15) ^{*2}	1	3 digits (0 - 9)	-	4 digits (0 - 9)	2	-	bit 8	bit 8
	D9	-	-		2		-		4	-	bit 9	bit 9
	DA	-	-		4		-		8	-	bit 10	bit 10
	DB	-	-		8		-		-	-	bit 11	bit 11
	DC	-	-	-	-	4 digits (0 - 15) ^{*2}	-	5 digits (0 - 3)	2	-	-	bit 12
	DD	-	-	-	-		4		-	-	bit 13	
	DE	-	-	-	-		8		-	-	bit 14	
	DF	-	-	-	-		1		-	-	bit 15	
TB1	SI	SIGN (encoded) signal 0: Forward run, 1: Reverse run						2	SIGN (encoded) signal 0: Forward run, 1: Reverse run			
	SE	SET (loaded) signal 1: Loads the value set for D0 to DF and SI.										
	SP	Internal power supply: 24 V ± 5%										
	SC	Input signal common										
	SN	Internal power supply common: 0 V										
	SD	Cable sheath connection terminal (ungrounded)										
	FE	Cable sheath connection terminal (grounded)										

*1 Setting F3-03 = 2 [Digital Input Data Length Select = 16-bit] enables F3-01 = 6 [Digital Input Function Selection = BCD (5-digit), 0.01 Hz] and a frequency between 0.00 Hz to 399.8 Hz can be set by the BCD. Note that terminal SI is also used as for data bits. Negative commands cannot be input as encoding information (positive/negative) cannot be added to the data.

The minimum bit value for the first BCD digit is 2. For this reason, 0.02 Hz is the smallest setting unit available for this frequency setting. An oPE05 [Run Cmd/Freq Ref Source Sel Err] occurs when F3-03 ≠ 2 while F3-01 = 6.

*2 The most significant digit can be set to a value between 0 to 15 when using "BCD, Signed". Other digits can be set to a value between 0 to 9.

F3-10: Terminal D0 Function Selection

No. (Hex.)	Name	Description	Default (Range)
F3-10 (0BE3) Expert	Terminal D0 Function Selection	V/f CL-V/f OLV CLV AOLV OLV/PM AOLV/PM CLV/PM EZOLV Sets the function for terminal D0 of the DI-A3 option when F3-01 = 8 [Digital Input Function Selection = Multi-Function Digital Input].	F (1 - 19F)

Parameter Details

■ **F3-11: Terminal D1 Function Selection**

No. (Hex.)	Name	Description	Default (Range)
F3-11 (0BE4) Expert	Terminal D1 Function Selection	<p>V/f CL-V/f OLV CLV AOLV OLV/PM AOLV/PM CLV/PM EZOLV</p> <p>Sets the function for terminal D1 of the DI-A3 option when $F3-01 = 8$ [Digital Input Function Selection = Multi-Function Digital Input].</p>	F (1 - 19F)

■ **F3-12: Terminal D2 Function Selection**

No. (Hex.)	Name	Description	Default (Range)
F3-12 (0BE5) Expert	Terminal D2 Function Selection	<p>V/f CL-V/f OLV CLV AOLV OLV/PM AOLV/PM CLV/PM EZOLV</p> <p>Sets the function for terminal D2 of the DI-A3 option when $F3-01 = 8$ [Digital Input Function Selection = Multi-Function Digital Input].</p>	F (1 - 19F)

■ **F3-13: Terminal D3 Function Selection**

No. (Hex.)	Name	Description	Default (Range)
F3-13 (0BE6) Expert	Terminal D3 Function Selection	<p>V/f CL-V/f OLV CLV AOLV OLV/PM AOLV/PM CLV/PM EZOLV</p> <p>Sets the function for terminal D3 of the DI-A3 option when $F3-01 = 8$ [Digital Input Function Selection = Multi-Function Digital Input].</p>	F (1 - 19F)

■ **F3-14: Terminal D4 Function Selection**

No. (Hex.)	Name	Description	Default (Range)
F3-14 (0BE7) Expert	Terminal D4 Function Selection	<p>V/f CL-V/f OLV CLV AOLV OLV/PM AOLV/PM CLV/PM EZOLV</p> <p>Sets the function for terminal D4 of the DI-A3 option when $F3-01 = 8$ [Digital Input Function Selection = Multi-Function Digital Input].</p>	F (1 - 19F)

■ **F3-15: Terminal D5 Function Selection**

No. (Hex.)	Name	Description	Default (Range)
F3-15 (0BE8) Expert	Terminal D5 Function Selection	<p>V/f CL-V/f OLV CLV AOLV OLV/PM AOLV/PM CLV/PM EZOLV</p> <p>Sets the function for terminal D5 of the DI-A3 option when $F3-01 = 8$ [Digital Input Function Selection = Multi-Function Digital Input].</p>	F (1 - 19F)

■ **F3-16: Terminal D6 Function Selection**

No. (Hex.)	Name	Description	Default (Range)
F3-16 (0BE9) Expert	Terminal D6 Function Selection	<p>V/f CL-V/f OLV CLV AOLV OLV/PM AOLV/PM CLV/PM EZOLV</p> <p>Sets the function for terminal D6 of the DI-A3 option when $F3-01 = 8$ [Digital Input Function Selection = Multi-Function Digital Input].</p>	F (1 - 19F)

■ **F3-17: Terminal D7 Function Selection**

No. (Hex.)	Name	Description	Default (Range)
F3-17 (0BEA) Expert	Terminal D7 Function Selection	<p>V/f CL-V/f OLV CLV AOLV OLV/PM AOLV/PM CLV/PM EZOLV</p> <p>Sets the function for terminal D7 of the DI-A3 option when $F3-01 = 8$ [Digital Input Function Selection = Multi-Function Digital Input].</p>	F (1 - 19F)

■ **F3-18: Terminal D8 Function Selection**

No. (Hex.)	Name	Description	Default (Range)
F3-18 (0BEB) Expert	Terminal D8 Function Selection	<p>V/f CL-V/f OLV CLV AOLV OLV/PM AOLV/PM CLV/PM EZOLV</p> <p>Sets the function for terminal D8 of the DI-A3 option when $F3-01 = 8$ [Digital Input Function Selection = Multi-Function Digital Input].</p>	F (1 - 19F)

■ F3-19: Terminal D9 Function Selection

No. (Hex.)	Name	Description	Default (Range)
F3-19 (0BEC) Expert	Terminal D9 Function Selection	V/f CL-V/f OLV CLV AOLV OLV/PM AOLV/PM CLV/PM EZOLV Sets the function for terminal D9 of the DI-A3 option when $F3-01 = 8$ [Digital Input Function Selection = Multi-Function Digital Input].	F (1 - 19F)

■ F3-20: Terminal DA Function Selection

No. (Hex.)	Name	Description	Default (Range)
F3-20 (0BED) Expert	Terminal DA Function Selection	V/f CL-V/f OLV CLV AOLV OLV/PM AOLV/PM CLV/PM EZOLV Sets the function for terminal DA of the DI-A3 option when $F3-01 = 8$ [Digital Input Function Selection = Multi-Function Digital Input].	F (1 - 19F)

■ F3-21: Terminal DB Function Selection

No. (Hex.)	Name	Description	Default (Range)
F3-21 (0BEE) Expert	Terminal DB Function Selection	V/f CL-V/f OLV CLV AOLV OLV/PM AOLV/PM CLV/PM EZOLV Sets the function for terminal DB of the DI-A3 option when $F3-01 = 8$ [Digital Input Function Selection = Multi-Function Digital Input].	F (1 - 19F)

■ F3-22: Terminal DC Function Selection

No. (Hex.)	Name	Description	Default (Range)
F3-22 (0BEF) Expert	Terminal DC Function Selection	V/f CL-V/f OLV CLV AOLV OLV/PM AOLV/PM CLV/PM EZOLV Sets the function for terminal DC of the DI-A3 option when $F3-01 = 8$ [Digital Input Function Selection = Multi-Function Digital Input].	F (1 - 19F)

■ F3-23: Terminal DD Function Selection

No. (Hex.)	Name	Description	Default (Range)
F3-23 (0BF0) Expert	Terminal DD Function Selection	V/f CL-V/f OLV CLV AOLV OLV/PM AOLV/PM CLV/PM EZOLV Sets the function for terminal DD of the DI-A3 option when $F3-01 = 8$ [Digital Input Function Selection = Multi-Function Digital Input].	F (1 - 19F)

■ F3-24: Terminal DE Function Selection

No. (Hex.)	Name	Description	Default (Range)
F3-24 (0BF1) Expert	Terminal DE Function Selection	V/f CL-V/f OLV CLV AOLV OLV/PM AOLV/PM CLV/PM EZOLV Sets the function for terminal DE of the DI-A3 option when $F3-01 = 8$ [Digital Input Function Selection = Multi-Function Digital Input].	F (1 - 19F)

■ F3-25: Terminal DF Function Selection

No. (Hex.)	Name	Description	Default (Range)
F3-25 (0BF2) Expert	Terminal DF Function Selection	V/f CL-V/f OLV CLV AOLV OLV/PM AOLV/PM CLV/PM EZOLV Sets the function for terminal DF of the DI-A3 option when $F3-01 = 8$ [Digital Input Function Selection = Multi-Function Digital Input].	F (1 - 19F)

◆ F4: Analog Monitor Option

F4 parameters set drive operation when you use analog monitor option card AO-A3. The AO-A3 card has 2 output terminals (terminals V1 and V2) for signals with an Output resolution of 11 bits (1/2048) + encoding and that have an output voltage range of -10 V to +10 V. Install the AO-A3 card to a drive to output analog signals that monitor the output status of the drive (output frequency and output current).

Refer to the AO-A3 card manual for more information about how to install, wire, and set the AO-A3 card.

Use the *U monitor* number to set the monitor data to be output from terminals V1 and V2 on the AO-A3 card. Enter the last three digits of *Ux-xx* as the setting value.

• Use Gain and Bias to Adjust the Output Signal Level of Terminal V1

You must stop the drive to adjust the output signal. Use this procedure to calibrate the drive:

1. View the *F4-02 [Terminal V1 Gain]* value on the keypad.
Terminal V1 will output a voltage = 100% of the monitor set in *F4-01 [Terminal V1 Function Selection]*.
2. View the monitor connected to terminal V1 and adjust *F4-02*.
3. View the *F4-05 [Terminal V1 Bias]* value on the keypad.
Terminal V1 will output an analog signal = 100% of the parameter set in *F4-01*.
4. View the monitor connected to terminal V1 and adjust *F4-05*.

• Use Gain and Bias to Adjust the Output Signal Level of Terminal V2

You must stop the drive to adjust the output signal. Use this procedure to calibrate the drive:

1. View the *F4-04 [Terminal V2 Gain]* value on the keypad.
Terminal V2 will output a voltage = 100% of the monitor set in *F4-03 [Terminal V2 Function Selection]*.
2. View the monitor connected to terminal V2 and adjust *F4-04*.
3. View the *F4-06 [Terminal V2 Bias]* value on the keypad.
The analog signal equal to 0% of the parameter being set in *F4-03* will be output from terminal V2.
4. View the monitor connected to terminal V2 and adjust *F4-06*.

■ **F4-01: Terminal V1 Function Selection**

No. (Hex.)	Name	Description	Default (Range)
F4-01 (0391)	Terminal V1 Function Selection	V/f CL-V/f OLV CLV AOLV OLV/IPM AOLV/IPM CLV/IPM EZOLV Sets the monitor signal (<i>Ux-xx</i>) output from terminal V1.	102 (000 - 9999)

Note:

- Set the *x-xx* part of the *Ux-xx [Monitor]*. For example, set *F4-01 = 102* to monitor *U1-02 [Output Frequency]*.
When the *x* part of *Ux* is a letter, replace the letter (hexadecimal number) with a decimal number. For example, set *F4-01 = 1301* to monitor *Ud-01*.
- You cannot use all of the monitors in all of the control methods.
- When you use the terminal in through mode, set this parameter to *000* or *031*. You can use this setting to adjust the V1 terminal output from PLC through MEMOBUS/Modbus communications or a communications option.

■ **F4-02: Terminal V1 Gain**

No. (Hex.)	Name	Description	Default (Range)
F4-02 (0392) RUN	Terminal V1 Gain	V/f CL-V/f OLV CLV AOLV OLV/IPM AOLV/IPM CLV/IPM EZOLV Sets the gain of the monitor signal that is sent from terminal V1. Sets the analog signal output level from the terminal V1 at 10 V or 20 mA as 100% when an output for monitoring items is 100%.	100.0% (-999.9 - +999.9%)

The maximum output voltage output from terminal V1 is ±10 V. Use *F4-07 [Terminal V1 Signal Level]* to set the signal level.

Example settings:

When you use these settings, and the monitored output voltage is at 100% (drive rated current), the output voltage of terminal V1 is 5 V (50% of 10 V). The output current is 200% of the drive rated current when terminal V1 outputs a maximum voltage of 10 V.

- *F4-01 [Terminal V1 Function Selection] = 102 (U1-02: Output Frequency)*
- *F4-02 = 50.0%*
- *F4-05 [Terminal V1 Bias] = 0.0%*
- *F4-07 = 0 (0 V to 10 V)*

■ **F4-03: Terminal V2 Function Selection**

No. (Hex.)	Name	Description	Default (Range)
F4-03 (0393)	Terminal V2 Function Selection	V/f CL-V/f OLV CLV AOLV OLV/IPM AOLV/IPM CLV/IPM EZOLV Sets the monitor signal (<i>Ux-xx</i>) output from terminal V2.	103 (000 - 9999)

Note:

- Set the *x-xx* part of the *Ux-xx [Monitor]*. For example, set *F4-03 = 103* to monitor *U1-03 [Output Current]*. When the *x* part of *Ux* is a letter, replace the letter (hexadecimal number) with a decimal number. For example, set *F4-03 = 1301* to monitor *Ud-01*.
- You cannot use all of the monitors in all of the control methods.
- When you use the terminal in through mode, set this parameter to *000* or *031*. You can use this setting to adjust the V2 terminal output from PLC through MEMOBUS/Modbus communications or a communications option.

■ F4-04: Terminal V2 Gain

No. (Hex.)	Name	Description	Default (Range)
F4-04 (0394) RUN	Terminal V2 Gain	V/f CL-V/f OLV CLV AOLV OLV/PM AOLV/PM CLV/PM EZOLV Sets the gain of the monitor signal that is sent from terminal V2. Sets the analog signal output level from terminal V2 at 10 V or 20 mA as 100% when an output for monitoring items is 100%.	50.0% (-999.9 - +999.9%)

The maximum output voltage output from terminal V2 is ± 10 V. Use *F4-08 [Terminal V2 Signal Level]* to set the signal level.

Example settings:

When you use these settings, and the monitored output voltage is at 100% (drive rated current), the output voltage of terminal V2 is 5 V (50% of 10 V). The output current is 200% of the drive rated current when terminal V2 outputs a maximum voltage of 10 V.

- F4-03 [Terminal V2 Function Selection] = 103 (U1-03: Output Current)
- F4-04 = 50.0%
- F4-06 [Terminal V2 Bias] = 0.0%
- F4-08 = 0 (0 V to 10 V)

■ F4-05: Terminal V1 Bias

No. (Hex.)	Name	Description	Default (Range)
F4-05 (0395) RUN	Terminal V1 Bias	V/f CL-V/f OLV CLV AOLV OLV/PM AOLV/PM CLV/PM EZOLV Sets the bias of the monitor signal that is sent from terminal V1. When an output for monitoring items is 0%, this parameter sets the analog signal output level from the V1 terminal as a percentage of 10 V or 20 mA.	0.0% (-999.9 - +999.9%)

The maximum output voltage output from terminal V1 is ± 10 V. Use *F4-07 [Terminal V1 Signal Level]* to set the signal level.

■ F4-06: Terminal V2 Bias

No. (Hex.)	Name	Description	Default (Range)
F4-06 (0396) RUN	Terminal V2 Bias	V/f CL-V/f OLV CLV AOLV OLV/PM AOLV/PM CLV/PM EZOLV Sets the bias of the monitor signal that is sent from terminal V2. Set the level of the analog signal sent from the V2 terminal at 10 V or 20 mA as 100% when an output for monitoring items is 0%.	0.0% (-999.9 - +999.9%)

The maximum output voltage output from terminal V2 is ± 10 V. Use *F4-08 [Terminal V2 Signal Level]* to set the signal level.

■ F4-07: Terminal V1 Signal Level

No. (Hex.)	Name	Description	Default (Range)
F4-07 (0397)	Terminal V1 Signal Level	V/f CL-V/f OLV CLV AOLV OLV/PM AOLV/PM CLV/PM EZOLV Sets the output signal level for terminal V1.	0 (0, 1)

0 : 0 to 10 V

1 : -10 to 10 V

■ F4-08: Terminal V2 Signal Level

No. (Hex.)	Name	Description	Default (Range)
F4-08 (0398)	Terminal V2 Signal Level	V/f CL-V/f OLV CLV AOLV OLV/PM AOLV/PM CLV/PM EZOLV Sets the output signal level for terminal V2.	0 (0, 1)

0 : 0 to 10 V
1 : -10 to 10 V

◆ **F5: Digital Output Option**

F5 parameters set the output mode and function of output signals when you use digital output option card DO-A3. When you install a DO-A3 to the drive, you can output isolated digital signals to monitor the drive operation status.

- 6 points of photocoupler output (48 V, 50 mA or less)
- 2 points of relay contact output (250 Vac, 30 Vdc: 1 A or less)

Refer to the DO-A3 option manual for more information about how to install, wire, and set the DO-A3 card.

■ **Use Parameters to Select Output Modes**

Use parameter F5-09 [DO-A3 Output Mode Selection] to set signal output from the DO-A3 card.

Table 12.50 Details of F5-09 and the DO-A3 Terminal Output

DO-A3 Terminal Block	DO-A3 Terminal Name	F5-09 = 0 [Predefined Individual Outputs] (Default)	F5-09 = 1 [Binary Output]	F5-09 = 2 [Programmable (F5-01 to F5-08)]
TB1	M1-M2	Zero speed detection in progress	During run	Depending on the setting of F5-07 [Terminal M1-M2 Function Select]
	M3-M4	During speed agreement	Minor fault (excluding bb [Baseblock])	Depending on the setting of F5-08 [Terminal M3-M4 Function Select]
TB2	P1-PC	oC [Overcurrent], GF [Ground Fault]	Coded output Note: Refer to Table 12.51 for more information.	Depending on the setting of F5-01 [Terminal P1-PC Function Select]
	P2-PC	ov [Overvoltage]		Depending on the setting of F5-02 [Terminal P2-PC Function Select]
	P3-PC	oL2 [Drive Overload] or oH2 [External Overheat (H1-XX=B)]		Depending on the setting of F5-03 [Terminal P3-PC Function Select]
	P4-PC	Not used		Depending on the setting of F5-04 [Terminal P4-PC Function Select]
	P5-PC	oS [Overspeed]	Zero speed detection in progress	Depending on the setting of F5-05 [Terminal P5-PC Function Select]
	P6-PC	oH, oH1 [Heatsink Overheat] or oL1 [Motor Overload]	During speed agreement	Depending on the setting of F5-06 [Terminal P6-PC Function Select]

Table 12.51 Binary Output [F5-09 = 1]

Coded Output (Binary)	Description	DO-A3 Terminal Block TB2			
		Terminal P1-PC	Terminal P2-PC	Terminal P3-PC	Terminal P4-PC
0	No fault	0	0	0	0
1	oC [Overcurrent], GF [Ground Fault]	1	0	0	0
2	ov [Overvoltage]	0	1	0	0
3	oL2 [Drive Overload]	1	1	0	0
4	oH, oH1 [Heatsink Overheat]	0	0	1	0
5	oS [Overspeed]	1	0	1	0
6	Not used	0	1	1	0
7	rr [Dynamic Braking Transistor Fault], rH [Braking Resistor Overheat]	1	1	1	0
8	EF1 to EF8 [External Fault (Terminals S1 to S8)]	0	0	0	1
9	CPFxx, oFAXx, oFbxx, oFCxx [Drive Hardware Fault] *	1	0	0	1
A	oL1 [Motor Overload]	0	1	0	1
B	Not used	1	1	0	1
C	Uv1 [DC Bus Undervoltage], Uv2 [Control Power Undervoltage], Uv3 [Soft Charge Answerback Fault]	0	0	1	1

Coded Output (Binary)	Description	DO-A3 Terminal Block TB2			
		Terminal P1-PC	Terminal P2-PC	Terminal P3-PC	Terminal P4-PC
D	dEv [Speed Deviation]	1	0	1	1
E	PGo [Encoder (PG) Feedback Loss]	0	1	1	1
F	Not used	1	1	1	1

*1 The “xx” characters are different for different faults.

■ Digital Output Option Terminal Output Selection

Refer to “H2: Multi-function Digital Output” for more information about the functions that output from the terminals when $F5-09 = 2$ [*DO-A3 Output Mode Selection = Programmable (F5-01 to F5-08)*]. Use $F5-01$ to $F5-08$ to set the output items.

No.	Name	Range	Default
F5-01	Terminal P1-PC Function Select	0 - 192	0: During Run
F5-02	Terminal P2-PC Function Select	0 - 192	1: Zero Speed
F5-03	Terminal P3-PC Function Select	0 - 192	2: Speed Agree 1
F5-04	Terminal P4-PC Function Select	0 - 192	4: Frequency Detection 1
F5-05	Terminal P5-PC Function Select	0 - 192	6: Drive Ready
F5-06	Terminal P6-PC Function Select	0 - 192	37: During Frequency Output
F5-07	Terminal M1-M2 Function Select	0 - 192	F: Not Used
F5-08	Terminal M3-M4 Function Select	0 - 192	F: Not Used

■ F5-01: Terminal P1-PC Function Select

No. (Hex.)	Name	Description	Default (Range)
F5-01 (0399)	Terminal P1-PC Function Select	<div style="display: flex; gap: 5px;"> V/f CL-V/f OLV CLV AOLV OLV/PM AOLV/PM CLV/PM EZOLV </div> Sets the function of terminal P1-PC on the DO-A3 option. Set $F5-09 = 2$ [<i>DO-A3 Output Mode Selection = Programmable (F5-01 to F5-08)</i>] to enable this function.	0 (0 - 1A7)

■ F5-02: Terminal P2-PC Function Select

No. (Hex.)	Name	Description	Default (Range)
F5-02 (039A)	Terminal P2-PC Function Select	<div style="display: flex; gap: 5px;"> V/f CL-V/f OLV CLV AOLV OLV/PM AOLV/PM CLV/PM EZOLV </div> Sets the function of terminal P2-PC on the DO-A3 option. Set $F5-09 = 2$ [<i>DO-A3 Output Mode Selection = Programmable (F5-01 to F5-08)</i>] to enable this function.	1 (0 - 1A7)

■ F5-03: Terminal P3-PC Function Select

No. (Hex.)	Name	Description	Default (Range)
F5-03 (039B)	Terminal P3-PC Function Select	<div style="display: flex; gap: 5px;"> V/f CL-V/f OLV CLV AOLV OLV/PM AOLV/PM CLV/PM EZOLV </div> Sets the function of terminal P3-PC on the DO-A3 option. Set $F5-09 = 2$ [<i>DO-A3 Output Mode Selection = Programmable (F5-01 to F5-08)</i>] to enable this function.	2 (0 - 1A7)

■ F5-04: Terminal P4-PC Function Select

No. (Hex.)	Name	Description	Default (Range)
F5-04 (039C)	Terminal P4-PC Function Select	<div style="display: flex; gap: 5px;"> V/f CL-V/f OLV CLV AOLV OLV/PM AOLV/PM CLV/PM EZOLV </div> Sets the function of terminal P4-PC on the DO-A3 option. Set $F5-09 = 2$ [<i>DO-A3 Output Mode Selection = Programmable (F5-01 to F5-08)</i>] to enable this function.	4 (0 - 1A7)

■ F5-05: Terminal P5-PC Function Select

No. (Hex.)	Name	Description	Default (Range)
F5-05 (039D)	Terminal P5-PC Function Select	<div style="display: flex; gap: 5px;"> V/f CL-V/f OLV CLV AOLV OLV/PM AOLV/PM CLV/PM EZOLV </div> Sets the function of terminal P5-PC on the DO-A3 option. Set $F5-09 = 2$ [<i>DO-A3 Output Mode Selection = Programmable (F5-01 to F5-08)</i>] to enable this function.	6 (0 - 1A7)

■ **F5-06: Terminal P6-PC Function Select**

No. (Hex.)	Name	Description	Default (Range)
F5-06 (039E)	Terminal P6-PC Function Select	<div style="display: flex; justify-content: space-between; align-items: center;"> V/f CL-V/f OLV CLV AOLV OLV/PM AOLV/PM CLV/PM EZOLV </div> <p>Sets the function of terminal P6-PC on the DO-A3 option. Set <i>F5-09 = 2</i> [DO-A3 Output Mode Selection = Programmable (F5-01 to F5-08)] to enable this function.</p>	37 (0 - 1A7)

■ **F5-07: Terminal M1-M2 Function Select**

No. (Hex.)	Name	Description	Default (Range)
F5-07 (039F)	Terminal M1-M2 Function Select	<div style="display: flex; justify-content: space-between; align-items: center;"> V/f CL-V/f OLV CLV AOLV OLV/PM AOLV/PM CLV/PM EZOLV </div> <p>Sets the function of terminal M3-M2 on the DO-A3 option. Set <i>F5-09 = 2</i> [DO-A3 Output Mode Selection = Programmable (F5-01 to F5-08)] to enable this function.</p>	F (0 - 1A7)

■ **F5-08: Terminal M3-M4 Function Select**

No. (Hex.)	Name	Description	Default (Range)
F5-08 (03A0)	Terminal M3-M4 Function Select	<div style="display: flex; justify-content: space-between; align-items: center;"> V/f CL-V/f OLV CLV AOLV OLV/PM AOLV/PM CLV/PM EZOLV </div> <p>Sets the function of terminal M3-M4 on the DO-A3 option. Set <i>F5-09 = 2</i> [DO-A3 Output Mode Selection = Programmable (F5-01 to F5-08)] to enable this function.</p>	F (0 - 1A7)

■ **F5-09: DO-A3 Output Mode Selection**

No. (Hex.)	Name	Description	Default (Range)
F5-09 (03A1)	DO-A3 Output Mode Selection	<div style="display: flex; justify-content: space-between; align-items: center;"> V/f CL-V/f OLV CLV AOLV OLV/PM AOLV/PM CLV/PM EZOLV </div> <p>Sets the output mode of signals from the DO-A3 option.</p>	0 (0 - 2)

Refer to [Table 12.50](#) for more information.

0 : Predefined Individual Outputs

1 : Binary Output

2 : Programmable (F5-01 to F5-08)

◆ **F6, F7: Communication Options**

F6 and *F7* parameters set the basic communication settings and method of fault detection for the communication option. The communication option parameters include common option parameters and communication protocol-specific parameters.

The following table lists the parameters that you need to set for each communication option.

Refer to the technical manual for each communication option for more information about how to install, wire, and configure the necessary details before you start communication.

WARNING! *Sudden Movement Hazard. Do test runs and examine the drive to make sure that the command references are correct. If you set the command reference incorrectly, it can cause damage to the drive or serious injury or death.*

Table 12.52 Correspondence Between Communication Protocols and Parameters (SI-C3, SI-T3, SI-ET3, SI-P3, SI-S3, and SI-ES3)

Parameter	CC-Link SI-C3	MECHATROLINK-II SI-T3	MECHATROLINK-III SI-ET3	PROFIBUS-DP SI-P3	CANopen SI-S3	EtherCAT SI-ES3
F6-01 - F6-03	x	x	x	x	x	x
F6-04	x	-	-	-	-	-
F6-06 - F6-08	x	x	x	x	x	x
F6-10, F6-11	x	-	-	-	-	-
F6-14	x	x	x	x	x	x
F6-16	x	x	x	x	x	x
F6-20, F6-21	-	x	x	-	-	-
F6-22	-	x	-	-	-	-
F6-23 - F6-26	-	x	x	-	-	-
F6-30 - F6-32	-	-	-	x	-	-

Parameter	CC-Link SI-C3	MECHATROLINK-II SI-T3	MECHATROLINK-III SI-ET3	PROFIBUS-DP SI-P3	CANopen SI-S3	EtherCAT SI-ES3
F6-35, F6-36	-	-	-	-	x	-
F6-45 - F6-49	-	-	-	-	-	-
F6-50 - F6-53	-	-	-	-	-	-
F6-54	-	-	-	-	-	-
F6-55 to F6-71	-	-	-	-	-	-
F7-01 - F7-15	-	-	-	-	-	-
F7-16	-	-	-	-	-	-
F7-17 - F7-42	-	-	-	-	-	-
F7-60 - F7-79	-	-	-	x	-	-

Table 12.53 Correspondence Between Communication Protocols and Parameters (SI-N3, SI-W3, SI-EM3, SI-EP3, and SI-EN3)

Parameter	DeviceNet SI-N3	LonWorks SI-W3	Modbus TCP/IP SI-EM3	PROFINET SI-EP3	EtherNet/IP SI-EN3
F6-01 - F6-03	x	x	x	x	x
F6-04	-	-	-	-	-
F6-06 - F6-08	x	x	x	x	x
F6-10, F6-11	-	-	-	-	-
F6-14	x	x	x	x	x
F6-16	x	x	x	x	x
F6-20, F6-21	-	-	-	-	-
F6-22	-	-	-	-	-
F6-23 - F6-26	-	-	-	-	-
F6-30 - F6-32	-	-	-	-	-
F6-35, F6-36	-	-	-	-	-
F6-45 - F6-49	-	-	-	-	-
F6-50 - F6-53	x	-	-	-	-
F6-54	x	-	-	-	x
F6-55 to F6-71	x	-	-	-	-
F7-01 - F7-15	-	-	x	x	x
F7-16	-	-	x	-	-
F7-17 - F7-42	-	-	-	x	x
F7-60 - F7-79	-	-	-	-	-

Table 12.54 Correspondence Between Communication Protocols and Parameters (JOHB-SMP3)

Parameter	EtherNet/IP JOHB-SMP3	PROFINET JOHB-SMP3	Modbus TCP/IP JOHB-SMP3	EtherCAT JOHB-SMP3
F6-01 - F6-03	x	x	x	x
F6-04	-	-	-	-
F6-06 - F6-08	x	x	x	x
F6-10, F6-11	-	-	-	-
F6-14	x	x	x	x
F6-16	x	x	x	x
F6-20, F6-21	-	-	-	-
F6-22	-	-	-	-
F6-23 - F6-26	-	-	-	-
F6-30 - F6-32	-	-	-	-
F6-35, F6-36	-	-	-	-

Parameter	EtherNet/IP JOHB-SMP3	PROFINET JOHB-SMP3	Modbus TCP/IP JOHB-SMP3	EtherCAT JOHB-SMP3
F6-45 - F6-49	-	-	-	-
F6-50 - F6-53	-	-	-	-
F6-54	x	-	-	-
F6-55 to F6-71	-	-	-	-
F7-01 - F7-15	x	x	x	-
F7-16	-	-	x	-
F7-17 - F7-42	x	x	-	-
F7-60 - F7-79	-	-	-	-

Gateway Mode

Note:

When you use Gateway Mode, do not install the communication option in slave drives. If you install a communication option in a slave drive, the drive commands and responses will not synchronize.

In gateway mode, you can use one communication option to communicate with more than one drive.

You can use one communication option to connect a maximum of five drives to the field bus communications. Refer to [Figure 12.79](#) for more information.

When you install a communication option on the master drive, you can use the RS-485 communication card to transmit data to slave drives that do not have a communication option.

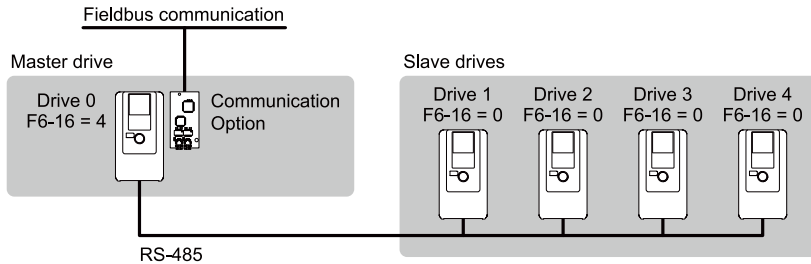

Figure 12.79 Connection Examples in Gateway Mode

Table 12.55 Specification

Item	Specification
Applicable options	All options that support the MEMOBUS access function (for example, PROFIBUS-DP, PROFINET, EtherNet/IP, EtherCAT)
Number of connected drives	Maximum: 5 units
Communication specifications	MEMOBUS/Modbus (RTUmode) communications
Commands/responses	The controller can send this data to each drive (Drive 0 to Drive 4): <ul style="list-style-type: none"> Control commands: Run commands and frequency references Control responses: Output frequency and drive status (during run, faults) Read and write parameters Read monitors
Synchronous control	Not supported

Note:

- The communication speed in gateway mode is slower than the speed in fieldbus communications. Make sure that the speed is acceptable for your system.
- Response speed with the communication option is slower than with point-to-point communications.
- Set *H5-02 [Communication Speed Selection]* and *H5-03 [Communication Parity Selection]* to the same value on the master drive and slave drives.

WARNING! Injury to Personnel. Separately prepare safety protection equipment and systems, for example fast stop switches. If the motor does not stop correctly from the disconnection of communications cable or electrical interference, it can cause serious injury.

Setting Gateway Mode

[Table 12.56](#) shows sample settings to connect 4 slave drives:

Table 12.56 Sample Settings for Using Gateway Mode

	F6-16 [Gateway Mode]	H5-01 [Drive Node Address] *7	H5-02 [Communication Speed Selection] H5-03 [Communication Parity Selection]	H5-06 [Drive Transmit Wait Time]	H5-09 [CE Detection Time]	b1-01 [Frequency Reference Selection 1]	b1-02 [Run Command Selection 1]
Drive 0 (Master Drive)	1 - 4 *2	1F (Default)	*5	5 ms (Default) *6	≥ 2.0 s *7	3 [Option PCB]	3 [Option PCB]
Drive 1 (Slave Drive)	0	01 *3 *4	*5	5 ms (Default) *6	≥ 0.9 s *7	2 [Memobus/ Modbus Communications] *8	2 [Memobus/ Modbus Communications] *8
Drive 2 (Slave Drive)	0	02 *3 *4	*5	5 ms (Default) *6	≥ 0.9 s *7	2 [Memobus/ Modbus Communications] *8	2 [Memobus/ Modbus Communications] *8
Drive 3 (Slave Drive)	0	03 *3 *4	*5	5 ms (Default) *6	≥ 0.9 s *7	2 [Memobus/ Modbus Communications] *8	2 [Memobus/ Modbus Communications] *8
Drive 4 (Slave Drive)	0	04 *3 *4	*5	5 ms (Default) *6	≥ 0.9 s *7	2 [Memobus/ Modbus Communications] *8	2 [Memobus/ Modbus Communications] *8

- *1 Re-energize the drive to apply the new settings.
 *2 Specify the number of slave drives you will connect.
 *3 Setting 0 will not let the drive respond to MEMOBUS/Modbus communications.
 *4 Set a slave address that is different from other slave devices.
 *5 Enter the same value that you use for the master drive.
 *6 To correctly detect the response timeout, do not change the value of H5-06 from the default value.
 *7 Set H5-09 ≥ 0.9 . When H5-09 < 0.9 , the drive will detect CE [Modbus Communication Error] before it detects a response timeout.
 *8 On each slave drive, set b1-01 [Frequency Reference Selection 1] and b1-02 [Run Command Selection 1] to 2 [Memobus/Modbus Communications].

An Overview of Gateway Mode

When in gateway mode, the drive will operate as shown in Table 12.57.

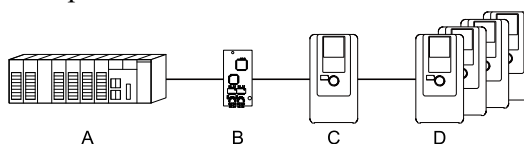

A - Controller

B - Communication option

C - Master Drive (Drive 0)

D - Slave Drives (Drives 1 to 4)

Table 12.57 Operation in Gateway Mode

Controller to Communication Option	Communication Option to Master Drive (Drive 0)	Master Drive (Drive 0) to Slave Drives (Drives 1 to 4)
<ul style="list-style-type: none"> The controller and card communicate in the format of each field bus communications protocol. Drive 0 sends commands and monitors through normal field bus communications. The special registers of Drive 0 use read and write to send commands to and monitor Drives 1 to 4. 	Field bus communication data is written to and read from the special registers of Drive 0.	<ul style="list-style-type: none"> Uses MEMOBUS communications. Drive 0 sends data from its special registers to Drives 1 to 4.

Note:

Energize the slave drive before you energize the master drive. If you energize the master drive first, the drive detects CE [Modbus Communication Error].

Operations at the Time of Communication Error

Communication Error	Error Codes	Operation
From controller to communication option	bUS	<ul style="list-style-type: none"> Master drive Detects <i>bUS</i> [Option Communication Error] and operates as specified by <i>F6-01</i> [Communication Error Selection]. Slave drive Detects <i>CE</i> [Modbus Communication Error] and operates as specified by <i>H5-04</i> [Communication Error Stop Method]. <p>Note:</p> <ul style="list-style-type: none"> After error detection, each drive can continue the operation specified by the last received command if the <i>F6-01</i> and <i>H5-04</i> settings agree. Because the controller cannot stop the operation, you must supply a stopping method, for example an emergency stop switch. If you set <i>H5-05</i> = 0 [Comm Fault Detection Selection = Disabled], the drive will not detect <i>CE</i>. The <i>H5-04</i> setting does not have an effect.
From communication option to master drive	oFAxx	<ul style="list-style-type: none"> Master drive Detects <i>oFAxx</i> and coasts to stop. Slave drive Detects <i>hLCE</i> [High Level Communication Errors] and coasts to stop.
From master drive to slave drive	CE	<p>The master drive stops communicating with the slave drive in these conditions: Reset the fault to restart communication.</p> <p>The slave drive detects <i>CE</i> after <i>H5-09</i> [CE Detection Time] is expired. Then it operates in as specified with <i>H5-04</i> [Communication Error Stop Method].</p> <ul style="list-style-type: none"> A message error occurred in the send data from the slave drive 10 consecutive times. Response from the slave drive timed out 10 consecutive times.

Gateway Special Register Specification

Table 12.58 Command Data

Register No. (Hex.)	Description	
15C5	Command source update	
	This flag enables command updates.	
	bit 0	Drive 1 Update Command Enabled
	To input the Run command and frequency reference at the same time, write all commands, then change the bit value from 0 to 1.	
	bit 1	Drive 2 Update Command Enabled
	bit 2	Drive 3 Update Command Enabled
	bit 3	Drive 4 Update Command Enabled
15C6	bit 4	Update Register Access Command Enabled
	bit 5 - F	Reserved
	Run Command (Drive 1)	
	bit 0	H5-12 = 0: FWD/Stop 0 = Stop 1 = Forward run
		H5-12 = 1: Run/Stop 0 = Stop 1 = Run
	bit 1	H5-12 = 0: REV/Stop 0 = Stop 1 = Reverse run
		H5-12 = 1: FWD/REV 0 = Forward run 1 = Reverse run
	bit 2	External fault
	bit 3	Fault Reset
bit 4	ComRef	
bit 5	ComCtrl	
bit 6 - F	Reserved	
15C7	Frequency Reference (Drive 1)	The unit of measure changes when <i>o1-03</i> changes.
15C8	Run Command (Drive 2)	Refer to "15C6: Run Command (Drive 1)" for more information.
15C9	Frequency Reference (Drive 2)	The unit of measure changes when <i>o1-03</i> changes.
15CA	Run Command (Drive 3)	Refer to "15C6: Run Command (Drive 1)" for more information.
15CB	Frequency Reference (Drive 3)	The unit of measure changes when <i>o1-03</i> changes.
15CC	Run Command (Drive 4)	Refer to "15C6: Run Command (Drive 1)" for more information.
15CD	Frequency Reference (Drive 4)	The unit of measure changes when <i>o1-03</i> changes.

Register No. (Hex.)	Description	
15CE	Slave Address for Reg. Access + Read/Write	
	bit 0	Slave address 0: Broadcast Messages (MEMOBUS) 1: Drive 1
	bit 1	2: Drive 2
	bit 2	3: Drive 3
	bit 3	4: Drive 4 5: Broadcast Messages (run command and frequency reference)
	bit 4	0: Read, 1: Write
	bit 5 - F	Reserved
15CF	Register number	
15D0	Data (write register)	

Table 12.59 Monitor Data

Register No. (Hex.)	Description		
15E7	Drive Status (Drive 1)		
	bit 0	During Run	
	bit 1	During Reverse Run	
	bit 2	Drive ready	
	bit 3	Fault	
	bit 4	Frequency Reference Setting Fault	1: Upper/Lower Limit Fault
	bit 5	No response from slave	1: Response has timed out.
	bit 6	Communication Error	1: The drive detected a fault from a slave.
	bit 7	No response from slave 10 consecutive attempts.	1: Timeout occurred 10 consecutive times.
	bit 8	Communication fault occurred 10 consecutive times.	1: Fault has occurred from a slave 10 consecutive times.
	bit 9	Receive broadcast command while drive is running	1: Drive operates as specified by the broadcast message command.
	bit A	Communication error with master drive	1: The slave cannot communicate with the master because of a communication error.
	bit B - D	Reserved	
	bit E	ComRef status	
bit F	ComCtrl status		
15E8	Output frequency or frequency reference (Drive Status Bit 1: ON) (Drive 1) Drive Status Bit 4 = 0 [Output Frequency] Drive Status Bit 4 = 1 [Frequency Reference]	The unit of measure changes when <i>o1-03</i> changes. Outputs when: • Normal operation: Output frequency • Drive detects Frequency Reference Setting Fault: Frequency reference when the error occurs Clears the value when the drive detects a communication error or communication stops.	
15E9	Drive Status (Drive 2)	Refer to "15E7: Drive Status (Drive 1)" for more information.	
15EA	Output frequency or frequency reference (Drive Status Bit 4: ON) (Drive 2)	The unit of measure changes when <i>o1-03</i> changes. Outputs when: • Normal operation: Output frequency • Drive detects Frequency Reference Setting Fault: Frequency reference when the error occurs Clears the value when the drive detects a communication error or communication stops.	
15EB	Drive Status (Drive 3)	Refer to "15E7: Drive Status (Drive 1)" for more information.	
15EC	Output frequency or frequency reference (Drive Status Bit 4: ON) (Drive 3)	The unit of measure changes when <i>o1-03</i> changes. Outputs when: • Normal operation: Output frequency • Drive detects Frequency Reference Setting Fault: Frequency reference when the error occurs Clears the value when the drive detects a communication error or communication stops.	
15ED	Drive Status (Drive 4)	Refer to "15E7: Drive Status (Drive 1)" for more information.	

12.7 F: Options

Register No. (Hex.)	Description		
15EE	Output frequency or frequency reference (Drive Status Bit 4: ON) (Drive 4)	The unit of measure changes when <i>o1-03</i> changes. Outputs when: <ul style="list-style-type: none"> Normal operation: Output frequency Drive detects Frequency Reference Setting Fault: Frequency reference when the error occurs Clears the value when the drive detects a communication error or communication stops.	
15EF	Slave Address for Reg. Access + During MEMOBUS process & ErrCode		
	bit 0 bit 1 bit 2 bit 3 bit 4 bit 5 bit 6 bit 7	00H: MEMOBUS/Modbus Communication Complete 02H: Register number not registered 21H: Upper/Lower Limit Fault 22H: Write Mode Error 23H: Write performed during <i>U_v</i> 24H: Write performed while writing parameter settings FFH: During MEMOBUS/Modbus Communication	Note: If you change the access command before the MEMOBUS/Modbus access flag turns on, the drive will not do the command from before.
	bit 8 bit 9 bit A	Slave address 0: Broadcast Messages (MEMOBUS) 1: Drive 1 2: Drive 2 3: Drive 3 4: Drive 4 5: Broadcast Messages (run command and frequency reference)	
	bit B - F	Reserved	
15F0	Register number		
15F1	Data (write register)		

■ F6-01: Communication Error Selection

No. (Hex.)	Name	Description	Default (Range)
F6-01 (03A2)	Communication Error Selection	<input type="checkbox"/> V/f <input type="checkbox"/> CL-V/f <input type="checkbox"/> OLV <input type="checkbox"/> CLV <input type="checkbox"/> AOLV <input type="checkbox"/> OLV/PM <input type="checkbox"/> AOLV/PM <input type="checkbox"/> CLV/PM <input type="checkbox"/> EZOLV Sets the method to stop the motor or let the motor continue operating when the drive detects <i>bUS</i> [Option Communication Error].	1 (0 - 5)

0 : Ramp to Stop

The drive ramps the motor to stop in the deceleration time. Fault relay output terminal MA-MC turns ON, and MB-MC turns OFF.

1 : Coast to Stop

The output turns off and the motor coasts to stop. Fault relay output terminal MA-MC turns ON, and MB-MC turns OFF.

2 : Fast Stop (Use C1-09)

The drive stops the motor in the deceleration time set in *C1-09* [Fast Stop Time]. Fault relay output terminal MA-MC turns ON, and MB-MC turns OFF.

3 : Alarm Only

The keypad shows *bUS* and the drive continues operation at the current frequency reference.

Note:

Separately prepare safety protection equipment and systems, for example fast stop switches.

The output terminal set for *Alarm* [*H2-01 to H2-03 = 10*] activates.

4 : Alarm (Run at d1-04)

The keypad shows *bUS* and the drive continues operation at the speed set in *d1-04* [Reference 4].

Note:

Separately prepare safety protection equipment and systems, for example fast stop switches.

5 : Alarm - Ramp Stop

The drive stops the motor in the deceleration time set in *C1-02* [Deceleration Time 1].

After you remove the *bUS* alarm, the motor will accelerate to the frequency reference you set before.

■ F6-02: Comm External Fault (EF0) Detect

No. (Hex.)	Name	Description	Default (Range)
F6-02 (03A3)	Comm External Fault (EF0) Detect	<input type="checkbox"/> V/f <input type="checkbox"/> CL-V/f <input type="checkbox"/> OLV <input type="checkbox"/> CLV <input type="checkbox"/> AOLV <input type="checkbox"/> OLV/PM <input type="checkbox"/> AOLV/PM <input type="checkbox"/> CLV/PM <input type="checkbox"/> EZOLV Sets the conditions at which <i>EF0</i> [Option Card External Fault] is detected.	0 (0, 1)

0 : Always Detected

1 : Detected during RUN Only

■ F6-03: Comm External Fault (EF0) Select

No. (Hex.)	Name	Description	Default (Range)
F6-03 (03A4)	Comm External Fault (EF0) Select	<input type="checkbox"/> V/f <input type="checkbox"/> CL-V/f <input type="checkbox"/> OLV <input type="checkbox"/> CLV <input type="checkbox"/> AOLV <input type="checkbox"/> OLV/PM <input type="checkbox"/> AOLV/PM <input type="checkbox"/> CLV/PM <input type="checkbox"/> EZOLV Sets the method to stop the motor or let the motor continue operating when the drive detects an <i>EF0</i> [Option Card External Fault].	1 (0 - 3)

0 : Ramp to Stop

The drive ramps the motor to stop in the deceleration time. Fault relay output terminal MA-MC turns ON, and MB-MC turns OFF.

1 : Coast to Stop

The output turns off and the motor coasts to stop. Fault relay output terminal MA-MC turns ON, and MB-MC turns OFF.

2 : Fast Stop (Use C1-09)

The drive stops the motor in the deceleration time set in *C1-09* [Fast Stop Time]. Fault relay output terminal MA-MC turns ON, and MB-MC turns OFF.

3 : Alarm Only

The keypad shows *EF0* and the drive continues operation.

Note:

Separately prepare safety protection equipment and systems, for example fast stop switches.

The output terminal set for *Alarm* [*H2-01 to H2-03 = 10*] activates.

■ F6-04: bUS Error Detection Time

No. (Hex.)	Name	Description	Default (Range)
F6-04 (03A5)	bUS Error Detection Time	<input type="checkbox"/> V/f <input type="checkbox"/> CL-V/f <input type="checkbox"/> OLV <input type="checkbox"/> CLV <input type="checkbox"/> AOLV <input type="checkbox"/> OLV/PM <input type="checkbox"/> AOLV/PM <input type="checkbox"/> CLV/PM <input type="checkbox"/> EZOLV Sets the delay time for the drive to detect <i>bUS</i> [Option Communication Error].	2.0 s (0.0 - 5.0 s)

Note:

When you install an option card in the drive, the parameter value changes to 0.0 s.

■ F6-06: Torque Reference/Limit by Comm

No. (Hex.)	Name	Description	Default (Range)
F6-06 (03A7)	Torque Reference/Limit by Comm	<input type="checkbox"/> V/f <input type="checkbox"/> CL-V/f <input type="checkbox"/> OLV <input type="checkbox"/> CLV <input type="checkbox"/> AOLV <input type="checkbox"/> OLV/PM <input type="checkbox"/> AOLV/PM <input type="checkbox"/> CLV/PM <input type="checkbox"/> EZOLV Sets the function that enables and disables the torque reference and torque limit received from the communication option.	0 (0, 1)

0 : Disabled

1 : Enabled

■ F6-07: Multi-Step Ref @ NetRef/ComRef

No. (Hex.)	Name	Description	Default (Range)
F6-07 (03A8)	Multi-Step Ref @ NetRef/ComRef	<input type="checkbox"/> V/f <input type="checkbox"/> CL-V/f <input type="checkbox"/> OLV <input type="checkbox"/> CLV <input type="checkbox"/> AOLV <input type="checkbox"/> OLV/PM <input type="checkbox"/> AOLV/PM <input type="checkbox"/> CLV/PM <input type="checkbox"/> EZOLV Sets the function that enables and disables the multi-step speed reference when the frequency reference source is NetRef or ComRef (communication option card or MEMOBUS/Modbus communications).	0 (0, 1)

0 : Disable Multi-Step References

When NetRef or ComRef are the frequency reference source, the multi-step speed reference (2-step speed to 16-step speed references) and the Jog Frequency Reference (JOG command) are disabled.

1 : Enable Multi-Step References

When NetRef or ComRef are the frequency reference source, the multi-step speed reference (2-step speed through 16-step speed references) and the Jog Frequency Reference (JOG command) are enabled, and you can change the frequency reference.

■ F6-08: Comm Parameter Reset @Initialize

No. (Hex.)	Name	Description	Default (Range)
F6-08 (036A)	Comm Parameter Reset @Initialize	V/f CL-V/f OLV CLV AOLV OLV/IPM AOLV/IPM CLV/IPM EZOLV Sets the function to initialize F6-xx and F7-xx parameters when the drive is initialized with A1-03 [Initialize Parameters].	0 (0, 1)

0 : No Reset - Parameters Retained

1 : Reset Back to Factory Default

Note:

When you use A1-03 to initialize the drive, this setting will not change.

■ F6-10: CC-Link Node Address

No. (Hex.)	Name	Description	Default (Range)
F6-10 (03B6)	CC-Link Node Address	V/f CL-V/f OLV CLV AOLV OLV/IPM AOLV/IPM CLV/IPM EZOLV Sets the node address for CC-Link communication. Restart the drive after you change the parameter setting.	0 (0 - 64)

Note:

Be sure to set a node address that is different than all other node addresses. Do not set this parameter to 0. Incorrect parameter settings will cause AEr [Station Address Setting Error] errors and the L.ERR LED on the option will come on.

When the only drive is connected, you can connect a maximum of 42 nodes. Follow these rules to connect devices that are not drives:

- $\{(1 \times a) + (2 \times b) + (3 \times c) + (4 \times d)\} \leq 64$
(a: number of units that occupies 1 node, b: number of units that occupies 2 nodes, c: number of units that occupies 3 nodes, d: number of units that occupies 4 nodes)
- $\{(16 \times A) + (54 \times B) + (88 \times C)\} \leq 2304$
(A: number of remote I/O nodes (64 max.), B: number of remote device nodes (42 max.), C: number of local nodes (26 max.))

■ F6-11: CC-Link Communication Speed

No. (Hex.)	Name	Description	Default (Range)
F6-11 (03B7)	CC-Link Communication Speed	V/f CL-V/f OLV CLV AOLV OLV/IPM AOLV/IPM CLV/IPM EZOLV Sets the communication speed for CC-Link communication. Restart the drive after you change the parameter setting.	0 (0 - 4)

0 : 156 kbps

1 : 625 kbps

2 : 2.5 Mbps

3 : 5 Mbps

4 : 10 Mbps

■ F6-14: BUS Error Auto Reset

No. (Hex.)	Name	Description	Default (Range)
F6-14 (03BB)	BUS Error Auto Reset	V/f CL-V/f OLV CLV AOLV OLV/IPM AOLV/IPM CLV/IPM EZOLV Sets the automatic reset function for bUS [Option Communication Errors].	0 (0, 1)

0 : Disable

1 : Enabled

■ F6-15: Comm. Option Parameters Reload

No. (Hex.)	Name	Description	Default (Range)
F6-15 (0B5B)	Comm. Option Parameters Reload	V/f CL-V/f OLV CLV AOLV OLV/PM AOLV/PM CLV/PM EZOLV Sets the update method when you change F6-xx, F7-xx [Communication Options].	0 (0 - 2)

Note:

- Set F6-15 = 0, 1 to reload F6-xx, F7-xx.
- Set F6-15 = 0, 1 to reset the display on the keypad to 0.

0 : Reload at Next Power Cycle

Restart the drive to update parameters.

1 : Reload Now

The changed parameters are updated without restarting the drive.

2 : Cancel Reload Request

Cancels CyPo [Cycle Power to Accept Changes].

■ F6-16: Gateway Mode

No. (Hex.)	Name	Description	Default (Range)
F6-16 (0B8A)	Gateway Mode	V/f CL-V/f OLV CLV AOLV OLV/PM AOLV/PM CLV/PM EZOLV Sets the gateway mode operation and the number of connected slave drives.	0 (0 to 4)

0 : Disabled

1 : Enabled: 1 Slave Drives

2 : Enabled: 2 Slave Drives

3 : Enabled: 3 Slave Drives

4 : Enabled: 4 Slave Drives

■ F6-20: MECHATROLINK Station Address

No. (Hex.)	Name	Description	Default (Range)
F6-20 (036B)	MECHATROLINK Station Address	V/f CL-V/f OLV CLV AOLV OLV/PM AOLV/PM CLV/PM EZOLV Sets the station address for MECHATROLINK communication. Restart the drive after you change the parameter setting.	0021h (MECHATROLINK-II: 0020h - 003Fh, MECHATROLINK-III: 0003h - 00EFh)

Note:

- The setting range changes if using MECHATROLINK-II or MECHATROLINK-III:
 - MECHATROLINK-II (SI-T3) range: 20 to 3F
 - MECHATROLINK-III (SI-ET3) range: 03 to EF
- Be sure to set a node address that is different than all other node addresses. Incorrect parameter settings will cause AEr [Station Address Setting Error] errors and the L.ERR LED on the option will come on.
- The drive detects AEr errors when the station address is 20 or 3F.

■ F6-21: MECHATROLINK Frame Size

No. (Hex.)	Name	Description	Default (Range)
F6-21 (036C)	MECHATROLINK Frame Size	V/f CL-V/f OLV CLV AOLV OLV/PM AOLV/PM CLV/PM EZOLV Sets the frame size for MECHATROLINK communication. Restart the drive after you change the parameter setting.	0 (0, 1)

0 : 32byte (M-2) / 64byte (M-3)

1 : 17byte (M-2) / 32byte (M-3)

■ F6-22: MECHATROLINK Link Speed

No. (Hex.)	Name	Description	Default (Range)
F6-22 (036D)	MECHATROLINK Link Speed	V/f CL-V/f OLV CLV AOLV OLV/PM AOLV/PM CLV/PM EZOLV Sets the communications speed for MECHATROLINK-II. Restart the drive after you change the parameter setting.	0 (0, 1)

Note:

This parameter is only available with the MECHATROLINK-II option.

0 : 10 Mbps

1 : 4 Mbps

■ **F6-23: MECHATROLINK Monitor Select (E)**

No. (Hex.)	Name	Description	Default (Range)
F6-23 (036E)	MECHATROLINK Monitor Select (E)	<div style="display: flex; justify-content: space-between; font-size: small;"> V/f CL-V/f OLV CLV AOLV OLV/PM AOLV/PM CLV/PM EZOLV </div> <p>Sets the MEMOBUS register used for the monitor functions of INV_CTL (drive operation control command) and INV_I/O (drive I/O control command). Restart the drive after you change the parameter setting.</p>	0000h (0000h - FFFFh)

To enable the MEMOBUS register set in F6-23, set SEL_MON2/1 to 0EH or set SEL_MON3/4 and SEL_MON5/6 to 0EH. Bytes of the response data enable the MEMOBUS register content that was set in F6-23.

■ **F6-24: MECHATROLINK Monitor Select (F)**

No. (Hex.)	Name	Description	Default (Range)
F6-24 (036F)	MECHATROLINK Monitor Select (F)	<div style="display: flex; justify-content: space-between; font-size: small;"> V/f CL-V/f OLV CLV AOLV OLV/PM AOLV/PM CLV/PM EZOLV </div> <p>Sets the MEMOBUS register used for the monitor functions of INV_CTL (drive operation control command) and INV_I/O (drive I/O control command). Restart the drive after you change the parameter setting.</p>	0000h (0000h - FFFFh)

To enable the MEMOBUS register set in F6-24, set SEL_MON2/1 to 0FH or set SEL_MON3/4 and SEL_MON5/6 to 0FH. Bytes of the response data enable the MEMOBUS register content that was set F6-24.

■ **F6-25: MECHATROLINK Watchdog Error Sel**

No. (Hex.)	Name	Description	Default (Range)
F6-25 (03C9)	MECHATROLINK Watchdog Error Sel	<div style="display: flex; justify-content: space-between; font-size: small;"> V/f CL-V/f OLV CLV AOLV OLV/PM AOLV/PM CLV/PM EZOLV </div> <p>Sets the method to stop the motor or let the motor continue operating when the drive detects an E5 [MECHATROLINK Watchdog Timer Err].</p>	1 (0 - 3)

0 : Ramp to Stop

The drive ramps the motor to stop in the deceleration time. Fault relay output terminal MA-MC turns ON, and MB-MC turns OFF.

1 : Coast to Stop

The output turns off and the motor coasts to stop. Fault relay output terminal MA-MC turns ON, and MB-MC turns OFF.

2 : Fast Stop (Use C1-09)

The drive stops the motor in the deceleration time set in C1-09 [Fast Stop Time]. Fault relay output terminal MA-MC turns ON, and MB-MC turns OFF.

3 : Alarm Only

The keypad shows E5, and the drive continues to operate.

Note:

Separately prepare safety protection equipment and systems, for example fast stop switches.

The output terminal set for Alarm [H2-01 to H2-03 = 10] activates.

■ **F6-26: MECHATROLINK Allowable No of Err**

No. (Hex.)	Name	Description	Default (Range)
F6-26 (03CA)	MECHATROLINK Allowable No of Err	<div style="display: flex; justify-content: space-between; font-size: small;"> V/f CL-V/f OLV CLV AOLV OLV/PM AOLV/PM CLV/PM EZOLV </div> <p>Sets the number of times that the option must detect a bUS alarm to cause a bUS [Option Communication Error].</p>	2 (2 - 10 times)

■ F6-30: PROFIBUS-DP Node Address

No. (Hex.)	Name	Description	Default (Range)
F6-30 (03CB)	PROFIBUS-DP Node Address	V/f CL-V/f OLV CLV AOLV OLV/PM AOLV/PM CLV/PM EZOLV Sets the node address for PROFIBUS-DP communication. Restart the drive after you change the parameter setting.	0 (0 - 125)

Note:

- Be sure to set a node address that is different than all other node addresses.
- Node addresses 0, 1, and 2 are usually reserved for control, maintenance, and device self-diagnosis.

■ F6-31: PROFIBUS-DP Clear Mode Selection

No. (Hex.)	Name	Description	Default (Range)
F6-31 (03CC)	PROFIBUS-DP Clear Mode Selection	V/f CL-V/f OLV CLV AOLV OLV/PM AOLV/PM CLV/PM EZOLV Sets what the drive will do after it receives the Clear Mode command.	0 (0, 1)

0 : Reset

Resets drive settings, for example frequency reference and I/O settings.

1 : Hold Previous State

The drive keeps the same status as before it received the command.

■ F6-32: PROFIBUS-DP Data Format Select

No. (Hex.)	Name	Description	Default (Range)
F6-32 (03CD)	PROFIBUS-DP Data Format Select	V/f CL-V/f OLV CLV AOLV OLV/PM AOLV/PM CLV/PM EZOLV Sets the data format of PROFIBUS-DP communication. Restart the drive after you change the parameter setting.	0 (0 - 5)

Note:

The H5-11 [Comm ENTER Command Mode] setting makes the RAM enter command necessary or not necessary to write parameters over network communication. When F6-32 = 0, 1, or 2, the H5-11 setting does not have an effect. The RAM enter command is always necessary to write parameters.

0 : PPO Type

1 : Conventional

2 : PPO (bit0)

This function operates when bit 0 and bit 4 in the register STW have values of 1 (operate). Refer to the PROFIBUS-DP communication manual for more information.

3 : PPO (Enter)

4 : Conventional (Enter)

5 : PPO (bit0, Enter)

This function operates when bit 0 and bit 4 in the register STW have values of 1 (operate). Refer to the PROFIBUS-DP communication manual for more information.

■ F6-35: CANopen Node ID Selection

No. (Hex.)	Name	Description	Default (Range)
F6-35 (03D0)	CANopen Node ID Selection	V/f CL-V/f OLV CLV AOLV OLV/PM AOLV/PM CLV/PM EZOLV Sets the node address for CANopen communication. Restart the drive after you change the parameter setting.	0 (0 - 126)

Note:

Be sure to set an address that is different than all other node addresses. Do not set this parameter to 0. Incorrect parameter settings will cause AEr [Station Address Setting Error] errors and the L.ERR LED on the option will come on.

■ F6-36: CANopen Communication Speed

No. (Hex.)	Name	Description	Default (Range)
F6-36 (03D1)	CANopen Communication Speed	V/f CL-V/f OLV CLV AOLV OLV/PM AOLV/PM CLV/PM EZOLV Sets the CANopen communications speed. Restart the drive after you change the parameter setting.	0 (0 - 8)

0 : Auto-detection

The drive detects the network communication speed and automatically adjusts the communications speed.

1 : 10 kbps**2 : 20 kbps****3 : 50 kbps****4 : 125 kbps****5 : 250 kbps****6 : 500 kbps****7 : 800 kbps****8 : 1 Mbps****■ F6-45: BACnet Node Address**

No. (Hex.)	Name	Description	Default (Range)
F6-45 (02FB)	BACnet Node Address	<input type="checkbox"/> V/f <input type="checkbox"/> CL-V/f <input type="checkbox"/> OLV <input type="checkbox"/> CLV <input type="checkbox"/> AOLV <input type="checkbox"/> OLV/IPM <input type="checkbox"/> AOLV/IPM <input type="checkbox"/> CLV/IPM <input type="checkbox"/> EZOLV Sets the node address for BACnet communication.	1 (0 - 127)

■ F6-46: BACnet Baud Rate

No. (Hex.)	Name	Description	Default (Range)
F6-46 (02FC)	BACnet Baud Rate	<input type="checkbox"/> V/f <input type="checkbox"/> CL-V/f <input type="checkbox"/> OLV <input type="checkbox"/> CLV <input type="checkbox"/> AOLV <input type="checkbox"/> OLV/IPM <input type="checkbox"/> AOLV/IPM <input type="checkbox"/> CLV/IPM <input type="checkbox"/> EZOLV Sets the BACnet communications speed.	3 (0 - 8)

0 : 1200 bps**1 : 2400 bps****2 : 4800 bps****3 : 9600 bps****4 : 19.2 kbps****5 : 38.4 kbps****6 : 57.6 kbps****7 : 76.8 kbps****8 : 115.2 kbps****■ F6-47: Rx to Tx Wait Time**

No. (Hex.)	Name	Description	Default (Range)
F6-47 (02FD)	Rx to Tx Wait Time	<input type="checkbox"/> V/f <input type="checkbox"/> CL-V/f <input type="checkbox"/> OLV <input type="checkbox"/> CLV <input type="checkbox"/> AOLV <input type="checkbox"/> OLV/IPM <input type="checkbox"/> AOLV/IPM <input type="checkbox"/> CLV/IPM <input type="checkbox"/> EZOLV Sets the wait time for the drive to receive and send BACnet communication.	5 ms (5 - 65 ms)

■ F6-48: BACnet Device Object Identifier0

No. (Hex.)	Name	Description	Default (Range)
F6-48 (02FE)	BACnet Device Object Identifier0	<input type="checkbox"/> V/f <input type="checkbox"/> CL-V/f <input type="checkbox"/> OLV <input type="checkbox"/> CLV <input type="checkbox"/> AOLV <input type="checkbox"/> OLV/IPM <input type="checkbox"/> AOLV/IPM <input type="checkbox"/> CLV/IPM <input type="checkbox"/> EZOLV Sets the last word of BACnet communication addresses.	0 (0 - FFFF)

■ F6-49: BACnet Device Object Identifier1

No. (Hex.)	Name	Description	Default (Range)
F6-49 (02FF)	BACnet Device Object Identifier1	<input type="checkbox"/> V/f <input type="checkbox"/> CL-V/f <input type="checkbox"/> OLV <input type="checkbox"/> CLV <input type="checkbox"/> AOLV <input type="checkbox"/> OLV/IPM <input type="checkbox"/> AOLV/IPM <input type="checkbox"/> CLV/IPM <input type="checkbox"/> EZOLV Sets the last word of BACnet communication addresses.	0 (0 - 3F)

■ F6-50: DeviceNet MAC Address

No. (Hex.)	Name	Description	Default (Range)
F6-50 (03C1)	DeviceNet MAC Address	V/f CL-V/f OLV CLV AOLV OLV/PM AOLV/PM CLV/PM EZOLV Sets the MAC address for DeviceNet communication. Restart the drive after you change the parameter setting.	0 (0 - 64)

Note:

Be sure to set a MAC address that is different than all other node addresses. Do not set this parameter to 0. Incorrect parameter settings will cause *AER* [Station Address Setting Error] errors and the MS LED on the option will flash.

■ F6-51: DeviceNet Baud Rate

No. (Hex.)	Name	Description	Default (Range)
F6-51 (03C2)	DeviceNet Baud Rate	V/f CL-V/f OLV CLV AOLV OLV/PM AOLV/PM CLV/PM EZOLV Sets the DeviceNet communications speed. Restart the drive after you change the parameter setting.	0 (0 - 4)

0 : 125 kbps

1 : 250 kbps

2 : 500 kbps

3 : Adjustable from Network

The controller sets the communications speed.

4 : Detect Automatically

The drive detects the network communication speed and automatically adjusts the communications speed.

■ F6-52: DeviceNet PCA Setting

No. (Hex.)	Name	Description	Default (Range)
F6-52 (03C3)	DeviceNet PCA Setting	V/f CL-V/f OLV CLV AOLV OLV/PM AOLV/PM CLV/PM EZOLV Sets the format of data that the DeviceNet communication master sends to the drive.	21 (0 - 255)

Note:

If F6-52 [DeviceNet PCA Setting] and F6-53 [DeviceNet PPA Setting] are not correct, the value is reset to default.

■ F6-53: DeviceNet PPA Setting

No. (Hex.)	Name	Description	Default (Range)
F6-53 (03C4)	DeviceNet PPA Setting	V/f CL-V/f OLV CLV AOLV OLV/PM AOLV/PM CLV/PM EZOLV Sets the format of data that the drive sends to the DeviceNet communication master.	71 (0 - 255)

Note:

If F6-52 [DeviceNet PCA Setting] and F6-53 [DeviceNet PPA Setting] are not correct, the value is reset to default.

■ F6-54: DeviceNet Idle Fault Detection

No. (Hex.)	Name	Description	Default (Range)
F6-54 (03C5)	DeviceNet Idle Fault Detection	V/f CL-V/f OLV CLV AOLV OLV/PM AOLV/PM CLV/PM EZOLV If the drive does not receive data from the DeviceNet or EtherNet/IP master, this parameter sets the function to detect <i>EF0</i> [Option Card External Fault].	0 (0 - 4)

0 : Enabled

1 : Disabled, No Fault Detection

This will not trigger *EF0*.

2 : Vendor Specific

3 : RUN Forward

4 : RUN Reverse

■ F6-55: DeviceNet Baud Rate Monitor

No. (Hex.)	Name	Description	Default (Range)
F6-55 (03C6)	DeviceNet Baud Rate Monitor	<div style="display: flex; justify-content: space-between; font-size: 0.8em; font-weight: bold;"> V/f CL-V/f OLV CLV AOLV OLV/PM AOLV/PM CLV/PM EZOLV </div> <p>Sets the function to see the actual DeviceNet communications speed using the keypad. This parameter functions as a monitor only.</p>	0 (0 - 2)

0 : 125 kbps

1 : 250 kbps

2 : 500 kbps

■ F6-56: DeviceNet Speed Scaling

No. (Hex.)	Name	Description	Default (Range)
F6-56 (03D7)	DeviceNet Speed Scaling	<div style="display: flex; justify-content: space-between; font-size: 0.8em; font-weight: bold;"> V/f CL-V/f OLV CLV AOLV OLV/PM AOLV/PM CLV/PM EZOLV </div> <p>Sets the speed scale for DeviceNet communication.</p>	0 (-15 - +15)

■ F6-57: DeviceNet Current Scaling

No. (Hex.)	Name	Description	Default (Range)
F6-57 (03D8)	DeviceNet Current Scaling	<div style="display: flex; justify-content: space-between; font-size: 0.8em; font-weight: bold;"> V/f CL-V/f OLV CLV AOLV OLV/PM AOLV/PM CLV/PM EZOLV </div> <p>Sets the current scale of the DeviceNet communication master.</p>	0 (-15 - +15)

■ F6-58: DeviceNet Torque Scaling

No. (Hex.)	Name	Description	Default (Range)
F6-58 (03D9)	DeviceNet Torque Scaling	<div style="display: flex; justify-content: space-between; font-size: 0.8em; font-weight: bold;"> V/f CL-V/f OLV CLV AOLV OLV/PM AOLV/PM CLV/PM EZOLV </div> <p>Sets the torque scale of the DeviceNet communication master.</p>	0 (-15 - +15)

■ F6-59: DeviceNet Power Scaling

No. (Hex.)	Name	Description	Default (Range)
F6-59 (03DA)	DeviceNet Power Scaling	<div style="display: flex; justify-content: space-between; font-size: 0.8em; font-weight: bold;"> V/f CL-V/f OLV CLV AOLV OLV/PM AOLV/PM CLV/PM EZOLV </div> <p>Sets the power scale of the DeviceNet communication master.</p>	0 (-15 - +15)

■ F6-60: DeviceNet Voltage Scaling

No. (Hex.)	Name	Description	Default (Range)
F6-60 (03DB)	DeviceNet Voltage Scaling	<div style="display: flex; justify-content: space-between; font-size: 0.8em; font-weight: bold;"> V/f CL-V/f OLV CLV AOLV OLV/PM AOLV/PM CLV/PM EZOLV </div> <p>Sets the voltage scale of the DeviceNet communication master.</p>	0 (-15 - +15)

■ F6-61: DeviceNet Time Scaling

No. (Hex.)	Name	Description	Default (Range)
F6-61 (03DC)	DeviceNet Time Scaling	<div style="display: flex; justify-content: space-between; font-size: 0.8em; font-weight: bold;"> V/f CL-V/f OLV CLV AOLV OLV/PM AOLV/PM CLV/PM EZOLV </div> <p>Sets the time scale of the DeviceNet communication master.</p>	0 (-15 - +15)

■ F6-62: DeviceNet Heartbeat Interval

No. (Hex.)	Name	Description	Default (Range)
F6-62 (03DD)	DeviceNet Heartbeat Interval	<div style="display: flex; justify-content: space-between; font-size: 0.8em; font-weight: bold;"> V/f CL-V/f OLV CLV AOLV OLV/PM AOLV/PM CLV/PM EZOLV </div> <p>Sets the heartbeat for DeviceNet communication. Set this parameter to 0 to disable the heartbeat function.</p>	0 (0 - 10)

■ F6-63: DeviceNet Network MAC ID

No. (Hex.)	Name	Description	Default (Range)
F6-63 (03DE)	DeviceNet Network MAC ID	V/f CL-V/f OLV CLV AOLV OLV/PM AOLV/PM CLV/PM EZOLV Sets the function to see the actual DeviceNet MAC address using the keypad. This parameter functions as a monitor only.	0 (0 - 63)

■ F6-64 to F6-67: Dynamic Out Assembly 109 Param1 to 4

No. (Hex.)	Name	Description	Default (Range)
F6-64 to F6-67 (03DF - 03E2)	Dynamic Out Assembly 109 Param 1 to 4	V/f CL-V/f OLV CLV AOLV OLV/PM AOLV/PM CLV/PM EZOLV Sets Configurable Outputs 1 to 4 written to the MEMOBUS register.	0000H (0000H - FFFFH)

■ F6-68 to F6-71: Dynamic In Assembly 159 Param 1 to 4

No. (Hex.)	Name	Description	Default (Range)
F6-68 to F6-71 (03E3, 03E4, 03C7, and 03C8)	Dynamic In Assembly 159 Param 1 to 4	V/f CL-V/f OLV CLV AOLV OLV/PM AOLV/PM CLV/PM EZOLV Sets Configurable Inputs 1 to 4 read from the MEMOBUS register.	0000H (0000H - FFFFH)

■ F6-72: PowerLink Node Address

No. (Hex.)	Name	Description	Default (Range)
F6-72 (081B)	PowerLink Node Address	V/f CL-V/f OLV CLV AOLV OLV/PM AOLV/PM CLV/PM EZOLV Sets the node ID for PowerLink communication.	0 (0 - 255)

■ F7-01: IP Address 1

No. (Hex.)	Name	Description	Default (Range)
F7-01 (03E5)	IP Address 1	V/f CL-V/f OLV CLV AOLV OLV/PM AOLV/PM CLV/PM EZOLV Sets the first octet of the IP Address for the device that is connecting to the network. Restart the drive after you change this parameter.	192 (0 - 255)

Note:

When *F7-13 = 0* [Address Mode at Startup = Static]:

- Use parameters *F7-01 to F7-04* [IP Address 1 to 4] to set the IP Address. Be sure to set a different IP address for each drive on the network.
- Also set parameters *F7-05 to F7-12* [Subnet Mask 1 to 4, Gateway Address 1 to 4].

■ F7-02: IP Address 2

No. (Hex.)	Name	Description	Default (Range)
F7-02 (03E6)	IP Address 2	V/f CL-V/f OLV CLV AOLV OLV/PM AOLV/PM CLV/PM EZOLV Sets the second octet of the IP Address for the device that is connecting to the network. Restart the drive after you change this parameter.	168 (0 - 255)

Note:

When *F7-13 = 0* [Address Mode at Startup = Static]:

- Use parameters *F7-01 to F7-04* [IP Address 1 to 4] to set the IP Address. Be sure to set a different IP address for each drive on the network.
- Also set parameters *F7-05 to F7-12* [Subnet Mask 1 to 4, Gateway Address 1 to 4].

■ F7-03: IP Address 3

No. (Hex.)	Name	Description	Default (Range)
F7-03 (03E7)	IP Address 3	V/f CL-V/f OLV CLV AOLV OLV/PM AOLV/PM CLV/PM EZOLV Sets the third octet of the IP Address for the device that is connecting to the network. Restart the drive after you change this parameter.	1 (0 - 255)

12.7 F: Options

Note:

When $F7-13 = 0$ [Address Mode at Startup = Static]:

- Use parameters $F7-01$ to $F7-04$ [IP Address 1 to 4] to set the IP Address. Be sure to set a different IP address for each drive on the network.
- Also set parameters $F7-05$ to $F7-12$ [Subnet Mask 1 to 4, Gateway Address 1 to 4].

■ F7-04: IP Address 4

No. (Hex.)	Name	Description	Default (Range)
F7-04 (03E8)	IP Address 4	<div style="display: flex; justify-content: space-between; font-size: 0.8em; font-weight: bold;"> V/f CL-V/f OLV CLV AOLV OLV/PM AOLV/PM CLV/PM EZOLV </div> <p>Sets the fourth octet of the IP Address for the device that is connecting to the network. Restart the drive after you change this parameter.</p>	20 (0 - 255)

Note:

When $F7-13 = 0$ [Address Mode at Startup = Static]:

- Use parameters $F7-01$ to $F7-04$ [IP Address 1 to 4] to set the IP Address. Be sure to set a different IP address for each drive on the network.
- Also set parameters $F7-05$ to $F7-12$ [Subnet Mask 1 to 4, Gateway Address 1 to 4].

■ F7-05: Subnet Mask 1

No. (Hex.)	Name	Description	Default (Range)
F7-05 (03E9)	Subnet Mask 1	<div style="display: flex; justify-content: space-between; font-size: 0.8em; font-weight: bold;"> V/f CL-V/f OLV CLV AOLV OLV/PM AOLV/PM CLV/PM EZOLV </div> <p>Sets the first octet of the subnet mask of the connected network.</p>	255 (0 - 255)

Note:

Set this parameter when $F7-13 = 0$ [Address Mode at Startup = Static].

■ F7-06: Subnet Mask 2

No. (Hex.)	Name	Description	Default (Range)
F7-06 (03EA)	Subnet Mask 2	<div style="display: flex; justify-content: space-between; font-size: 0.8em; font-weight: bold;"> V/f CL-V/f OLV CLV AOLV OLV/PM AOLV/PM CLV/PM EZOLV </div> <p>Sets the second octet of the subnet mask of the connected network.</p>	255 (0 - 255)

Note:

Set this parameter when $F7-13 = 0$ [Address Mode at Startup = Static].

■ F7-07: Subnet Mask 3

No. (Hex.)	Name	Description	Default (Range)
F7-07 (03EB)	Subnet Mask 3	<div style="display: flex; justify-content: space-between; font-size: 0.8em; font-weight: bold;"> V/f CL-V/f OLV CLV AOLV OLV/PM AOLV/PM CLV/PM EZOLV </div> <p>Sets the third octet of the subnet mask of the connected network.</p>	255 (0 - 255)

Note:

Set this parameter when $F7-13 = 0$ [Address Mode at Startup = Static].

■ F7-08: Subnet Mask 4

No. (Hex.)	Name	Description	Default (Range)
F7-08 (03EC)	Subnet Mask 4	<div style="display: flex; justify-content: space-between; font-size: 0.8em; font-weight: bold;"> V/f CL-V/f OLV CLV AOLV OLV/PM AOLV/PM CLV/PM EZOLV </div> <p>Sets the fourth octet of the subnet mask of the connected network.</p>	0 (0 - 255)

Note:

Set this parameter when $F7-13 = 0$ [Address Mode at Startup = Static].

■ F7-09: Gateway Address 1

No. (Hex.)	Name	Description	Default (Range)
F7-09 (03ED)	Gateway Address 1	<div style="display: flex; justify-content: space-between; font-size: 0.8em; font-weight: bold;"> V/f CL-V/f OLV CLV AOLV OLV/PM AOLV/PM CLV/PM EZOLV </div> <p>Sets the first octet of the gateway address of the connected network.</p>	192 (0 - 255)

Note:

Set this parameter when $F7-13 = 0$ [Address Mode at Startup = Static].

■ F7-10: Gateway Address 2

No. (Hex.)	Name	Description	Default (Range)
F7-10 (03EE)	Gateway Address 2	V/f CL-V/f OLV CLV AOLV OLV/PM AOLV/PM CLV/PM EZOLV Sets the second octet of the gateway address of the connected network.	168 (0 - 255)

Note:

Set this parameter when $F7-13 = 0$ [Address Mode at Startup = Static].

■ F7-11: Gateway Address 3

No. (Hex.)	Name	Description	Default (Range)
F7-11 (03EF)	Gateway Address 3	V/f CL-V/f OLV CLV AOLV OLV/PM AOLV/PM CLV/PM EZOLV Sets the third octet of the gateway address of the connected network.	1 (0 - 255)

Note:

Set this parameter when $F7-13 = 0$ [Address Mode at Startup = Static].

■ F7-12: Gateway Address 4

No. (Hex.)	Name	Description	Default (Range)
F7-12 (03F0)	Gateway Address 4	V/f CL-V/f OLV CLV AOLV OLV/PM AOLV/PM CLV/PM EZOLV Sets the fourth octet of the gateway address of the connected network.	1 (0 - 255)

Note:

Set this parameter when $F7-13 = 0$ [Address Mode at Startup = Static].

■ F7-13: Address Mode at Startup

No. (Hex.)	Name	Description	Default (Range)
F7-13 (03F1)	Address Mode at Startup	V/f CL-V/f OLV CLV AOLV OLV/PM AOLV/PM CLV/PM EZOLV Sets the method to set option card IP addresses.	2 (0 - 2)

0 : Static

1 : BOOTP

2 : DHCP

Note:

- The following setting values are available when using the PROFINET communication option card (SI-EP3).
 - 0: Static
 - 2: DCP
- When $F7-13 = 0$, set parameters $F7-01$ to $F7-12$ [IP Address 1 to Gateway Address 4] to set the IP Address. Be sure to set a different IP address for each drive on the network.

■ F7-14: Duplex Mode Selection

No. (Hex.)	Name	Description	Default (Range)
F7-14 (03F2)	Duplex Mode Selection	V/f CL-V/f OLV CLV AOLV OLV/PM AOLV/PM CLV/PM EZOLV Sets the duplex mode setting method.	1 (0 - 8)

0 : Half/Half

1 : Auto/Auto

2 : Full/Full

3 : Half/Auto

Port 1 is set to "Half" and port 2 is set to "Auto".

4 : Half/Full

Port 1 is set to "Half" and port 2 is set to "Full".

5 : Auto/Half

Port 1 is set to "Auto" and port 2 is set to "Half".

6 : Auto/Full

Port 1 is set to “Auto” and port 2 is set to “Full”.

7 : Full/Half

Port 1 is set to “Full” and port 2 is set to “Half”.

8 : Full/Auto

Port 1 is set to “Full” and port 2 is set to “Auto”.

■ F7-15: Communication Speed Selection

No. (Hex.)	Name	Description	Default (Range)
F7-15 (03F3)	Communication Speed Selection	<input type="checkbox"/> V/f <input type="checkbox"/> CL-V/f <input type="checkbox"/> OLV <input type="checkbox"/> CLV <input type="checkbox"/> AOLV <input type="checkbox"/> OLV/IPM <input type="checkbox"/> AOLV/IPM <input type="checkbox"/> CLV/IPM <input type="checkbox"/> EZOLV Sets the communications speed.	10 (10, 100 - 102)

10 : 10/10 Mbps

100 : 100/100 Mbps

101 : 10/100 Mbps

102 : 100/10 Mbps

Note:

Set this parameter when $F7-14 = 0$ or 2 [Duplex Mode Selection = Half/Half or Full/Full].

■ F7-16: Timeout Value

No. (Hex.)	Name	Description	Default (Range)
F7-16 (03F4)	Timeout Value	<input type="checkbox"/> V/f <input type="checkbox"/> CL-V/f <input type="checkbox"/> OLV <input type="checkbox"/> CLV <input type="checkbox"/> AOLV <input type="checkbox"/> OLV/IPM <input type="checkbox"/> AOLV/IPM <input type="checkbox"/> CLV/IPM <input type="checkbox"/> EZOLV Sets the detection time for a communications timeout.	0.0 s (0.0 - 30.0 s)

Note:

Set this parameter to 0.0 to disable the connection timeout function.

■ F7-17: EtherNet/IP Speed Scaling Factor

No. (Hex.)	Name	Description	Default (Range)
F7-17 (03F5)	EtherNet/IP Speed Scaling Factor	<input type="checkbox"/> V/f <input type="checkbox"/> CL-V/f <input type="checkbox"/> OLV <input type="checkbox"/> CLV <input type="checkbox"/> AOLV <input type="checkbox"/> OLV/IPM <input type="checkbox"/> AOLV/IPM <input type="checkbox"/> CLV/IPM <input type="checkbox"/> EZOLV Sets the scaling factor for the speed monitor in the EtherNet/IP Class ID 2AH Object.	0 (-15 - +15)

■ F7-18: EtherNet/IP Current Scale Factor

No. (Hex.)	Name	Description	Default (Range)
F7-18 (03F6)	EtherNet/IP Current Scale Factor	<input type="checkbox"/> V/f <input type="checkbox"/> CL-V/f <input type="checkbox"/> OLV <input type="checkbox"/> CLV <input type="checkbox"/> AOLV <input type="checkbox"/> OLV/IPM <input type="checkbox"/> AOLV/IPM <input type="checkbox"/> CLV/IPM <input type="checkbox"/> EZOLV Sets the scaling factor for the output current monitor in the EtherNet/IP Class ID 2AH Object.	0 (-15 - +15)

■ F7-19: EtherNet/IP Torque Scale Factor

No. (Hex.)	Name	Description	Default (Range)
F7-19 (03F7)	EtherNet/IP Torque Scale Factor	<input type="checkbox"/> V/f <input type="checkbox"/> CL-V/f <input type="checkbox"/> OLV <input type="checkbox"/> CLV <input type="checkbox"/> AOLV <input type="checkbox"/> OLV/IPM <input type="checkbox"/> AOLV/IPM <input type="checkbox"/> CLV/IPM <input type="checkbox"/> EZOLV Sets the scaling factor for the torque monitor in the EtherNet/IP Class ID 2AH Object.	0 (-15 - +15)

■ F7-20: EtherNet/IP Power Scaling Factor

No. (Hex.)	Name	Description	Default (Range)
F7-20 (03F8)	EtherNet/IP Power Scaling Factor	<input type="checkbox"/> V/f <input type="checkbox"/> CL-V/f <input type="checkbox"/> OLV <input type="checkbox"/> CLV <input type="checkbox"/> AOLV <input type="checkbox"/> OLV/IPM <input type="checkbox"/> AOLV/IPM <input type="checkbox"/> CLV/IPM <input type="checkbox"/> EZOLV Sets the scaling factor for the power monitor in the EtherNet/IP Class ID 2AH Object.	0 (-15 - +15)

■ F7-21: EtherNet/IP Voltage Scale Factor

No. (Hex.)	Name	Description	Default (Range)
F7-21 (03F9)	EtherNet/IP Voltage Scale Factor	<input type="checkbox"/> V/f <input type="checkbox"/> CL-V/f <input type="checkbox"/> OLV <input type="checkbox"/> CLV <input type="checkbox"/> AOLV <input type="checkbox"/> OLV/IPM <input type="checkbox"/> AOLV/IPM <input type="checkbox"/> CLV/IPM <input type="checkbox"/> EZOLV Sets the scaling factor for the voltage monitor in the EtherNet/IP Class ID 2AH Object.	0 (-15 - +15)

■ F7-22: EtherNet/IP Time Scaling

No. (Hex.)	Name	Description	Default (Range)
F7-22 (03FA)	EtherNet/IP Time Scaling	V/f CL-V/f OLV CLV AOLV OLV/PM AOLV/PM CLV/PM EZOLV Sets the scaling factor for the time monitor in the EtherNet/IP Class ID 2AH Object.	0 (-15 - +15)

■ F7-23 to F7-32: Dynamic Out Param 1 to 10 for CommCard

No. (Hex.)	Name	Description	Default (Range)
F7-23 to F7-27 (03FB - 03FF) F7-28 to F7-32 (0370 - 0374)	Dynamic Out Param 1 to 10 for CommCard	V/f CL-V/f OLV CLV AOLV OLV/PM AOLV/PM CLV/PM EZOLV When you use an Ethernet/IP option, sets Output Assembly 116. The drive writes the values from Output Assembly 116 to the MEMOBUS/Modbus address register that is stored for each parameter. The drive will not write the values from Output Assembly 116 to the registers when the MEMOBUS/Modbus address is 0. When you use a ProfiNet option, set F7-23 to F7-27 to configurable Output 1-5.	0

■ F7-33 to F7-42: Dynamic In Param 1 to 10 for CommCard

No. (Hex.)	Name	Description	Default (Range)
F7-33 to F7-42 (0375 - 037E)	Dynamic In Param 1 to 10 for CommCard	V/f CL-V/f OLV CLV AOLV OLV/PM AOLV/PM CLV/PM EZOLV When you use an Ethernet/IP option, sets Input Assembly 166. The drive sends the values from the MEMOBUS/Modbus address registers stored for each parameter to Input Assembly 166. The drive returns the default register value for the option card when the MEMOBUS/Modbus address is 0 and the value sent to Input Assembly 166 is not defined. When you use a ProfiNet option, set F7-33 to F7-37 to configurable inputs 1-5.	0

■ F7-60: PZD1 Write (Control Word)

No. (Hex.)	Name	Description	Default (Range)
F7-60 (0780)	PZD1 Write (Control Word)	V/f CL-V/f OLV CLV AOLV OLV/PM AOLV/PM CLV/PM EZOLV When you use a Profibus option, set the MEMOBUS/Modbus address for PZD1 (PPO output). PZD1 (PPO output) functions as the STW when F7-60 = 0 to 2.	0

■ F7-61: PZD2 Write (Frequency Reference)

No. (Hex.)	Name	Description	Default (Range)
F7-61 (0781)	PZD2 Write (Frequency Reference)	V/f CL-V/f OLV CLV AOLV OLV/PM AOLV/PM CLV/PM EZOLV When you use a Profibus option, sets the MEMOBUS/Modbus address for PZD2 (PPO output). PZD2 (PPO output) functions as the HSW when F7-61 = 0 to 2.	0

■ F7-62: PZD3 Write

No. (Hex.)	Name	Description	Default (Range)
F7-62 (0782)	PZD3 Write	V/f CL-V/f OLV CLV AOLV OLV/PM AOLV/PM CLV/PM EZOLV When you use a Profibus option, sets the MEMOBUS/Modbus address for PZD3 (PPO output). A value of 0, 1, or 2 will disable the PZD3 (PPO output) write operation to the MEMOBUS/Modbus register.	0

■ F7-63: PZD4 Write

No. (Hex.)	Name	Description	Default (Range)
F7-63 (0783)	PZD4 Write	V/f CL-V/f OLV CLV AOLV OLV/PM AOLV/PM CLV/PM EZOLV When you use a Profibus option, sets the MEMOBUS/Modbus address for PZD4 (PPO output). A value of 0, 1, or 2 will disable the PZD4 (PPO output) write operation to the MEMOBUS/Modbus register.	0

■ F7-64: PZD5 Write

No. (Hex.)	Name	Description	Default (Range)
F7-64 (0784)	PZD5 Write	V/f CL-V/f OLV CLV AOLV OLV/PM AOLV/PM CLV/PM EZOLV When you use a Profibus option, sets the MEMOBUS/Modbus address for PZD5 (PPO output). A value of 0, 1, or 2 will disable the PZD5 (PPO output) write operation to the MEMOBUS/Modbus register.	0

■ **F7-65: PZD6 Write**

No. (Hex.)	Name	Description	Default (Range)
F7-65 (0785)	PZD6 Write	<p>V/f CL-V/f OLV CLV AOLV OLV/PM AOLV/PM CLV/PM EZOLV</p> <p>When you use a Profibus option, sets the MEMOBUS/Modbus address for PZD6 (PPO output). A value of 0, 1, or 2 will disable the PZD6 (PPO output) write operation to the MEMOBUS/Modbus register.</p>	0

■ **F7-66: PZD7 Write**

No. (Hex.)	Name	Description	Default (Range)
F7-66 (0786)	PZD7 Write	<p>V/f CL-V/f OLV CLV AOLV OLV/PM AOLV/PM CLV/PM EZOLV</p> <p>When you use a Profibus option, sets the MEMOBUS/Modbus address for PZD7 (PPO output). A value of 0, 1, or 2 will disable the PZD7 (PPO output) write operation to the MEMOBUS/Modbus register.</p>	0

■ **F7-67: PZD8 Write**

No. (Hex.)	Name	Description	Default (Range)
F7-67 (0787)	PZD8 Write	<p>V/f CL-V/f OLV CLV AOLV OLV/PM AOLV/PM CLV/PM EZOLV</p> <p>When you use a Profibus option, sets the MEMOBUS/Modbus address for PZD8 (PPO output). A value of 0, 1, or 2 will disable the PZD8 (PPO output) write operation to the MEMOBUS/Modbus register.</p>	0

■ **F7-68: PZD9 Write**

No. (Hex.)	Name	Description	Default (Range)
F7-68 (0788)	PZD9 Write	<p>V/f CL-V/f OLV CLV AOLV OLV/PM AOLV/PM CLV/PM EZOLV</p> <p>When you use a Profibus option, sets the MEMOBUS/Modbus address for PZD9 (PPO output). A value of 0, 1, or 2 will disable the PZD9 (PPO output) write operation to the MEMOBUS/Modbus register.</p>	0

■ **F7-69: PZD10 Write**

No. (Hex.)	Name	Description	Default (Range)
F7-69 (0789)	PZD10 Write	<p>V/f CL-V/f OLV CLV AOLV OLV/PM AOLV/PM CLV/PM EZOLV</p> <p>When you use a Profibus option, sets the MEMOBUS/Modbus address for PZD10 (PPO output). A value of 0, 1, or 2 will disable the PZD10 (PPO output) write operation to the MEMOBUS/Modbus register.</p>	0

■ **F7-70: PZD1 Read (Status Word)**

No. (Hex.)	Name	Description	Default (Range)
F7-70 (078A)	PZD1 Read (Status Word)	<p>V/f CL-V/f OLV CLV AOLV OLV/PM AOLV/PM CLV/PM EZOLV</p> <p>When you use a Profibus option, sets the MEMOBUS/Modbus address for PZD1 (PPO input). PZD1 (PPO input) functions as the ZSW when <i>F7-70 = 0</i>.</p>	0

■ **F7-71: PZD2 Read (Output Frequency)**

No. (Hex.)	Name	Description	Default (Range)
F7-71 (078B)	PZD2 Read (Output Frequency)	<p>V/f CL-V/f OLV CLV AOLV OLV/PM AOLV/PM CLV/PM EZOLV</p> <p>When you use a Profibus option, sets the MEMOBUS/Modbus address for PZD2 (PPO input). PZD2 (PPO input) functions as the HIW when <i>F7-71 = 0</i>.</p>	0

■ **F7-72: PZD3 Read**

No. (Hex.)	Name	Description	Default (Range)
F7-72 (078C)	PZD3 Read	<p>V/f CL-V/f OLV CLV AOLV OLV/PM AOLV/PM CLV/PM EZOLV</p> <p>When you use a Profibus option, sets the MEMOBUS/Modbus address for PZD3 (PPO input). A value of 0 will disable the PZD3 (PPO input) load operation from the MEMOBUS/Modbus register.</p>	0

■ F7-73: PZD4 Read

No. (Hex.)	Name	Description	Default (Range)
F7-73 (078D)	PZD4 Read	<p>V/f CL-V/f OLV CLV AOLV OLV/PM AOLV/PM CLV/PM EZOLV</p> <p>When you use a Profibus option, sets the MEMOBUS/Modbus address for PZD4 (PPO input). A value of 0 will disable the PZD4 (PPO input) load operation from the MEMOBUS/Modbus register.</p>	0

■ F7-74: PZD5 Read

No. (Hex.)	Name	Description	Default (Range)
F7-74 (078E)	PZD5 Read	<p>V/f CL-V/f OLV CLV AOLV OLV/PM AOLV/PM CLV/PM EZOLV</p> <p>When you use a Profibus option, sets the MEMOBUS/Modbus address for PZD5 (PPO input). A value of 0 will disable the PZD5 (PPO input) load operation from the MEMOBUS/Modbus register.</p>	0

■ F7-75: PZD6 Read

No. (Hex.)	Name	Description	Default (Range)
F7-75 (078F)	PZD6 Read	<p>V/f CL-V/f OLV CLV AOLV OLV/PM AOLV/PM CLV/PM EZOLV</p> <p>When you use a Profibus option, sets the MEMOBUS/Modbus address for PZD6 (PPO input). A value of 0 will disable the PZD6 (PPO input) load operation from the MEMOBUS/Modbus register.</p>	0

■ F7-76: PZD7 Read

No. (Hex.)	Name	Description	Default (Range)
F7-76 (0790)	PZD7 Read	<p>V/f CL-V/f OLV CLV AOLV OLV/PM AOLV/PM CLV/PM EZOLV</p> <p>When you use a Profibus option, sets the MEMOBUS/Modbus address for PZD7 (PPO input). A value of 0 will disable the PZD7 (PPO input) load operation from the MEMOBUS/Modbus register.</p>	0

■ F7-77: PZD8 Read

No. (Hex.)	Name	Description	Default (Range)
F7-77 (0791)	PZD8 Read	<p>V/f CL-V/f OLV CLV AOLV OLV/PM AOLV/PM CLV/PM EZOLV</p> <p>When you use a Profibus option, sets the MEMOBUS/Modbus address for PZD8 (PPO input). A value of 0 will disable the PZD8 (PPO input) load operation from the MEMOBUS/Modbus register.</p>	0

■ F7-78: PZD9 Read

No. (Hex.)	Name	Description	Default (Range)
F7-78 (0792)	PZD9 Read	<p>V/f CL-V/f OLV CLV AOLV OLV/PM AOLV/PM CLV/PM EZOLV</p> <p>When you use a Profibus option, sets the MEMOBUS/Modbus address for PZD9 (PPO input). A value of 0 will disable the PZD9 (PPO input) load operation from the MEMOBUS/Modbus register.</p>	0

■ F7-79: PZD10 Read

No. (Hex.)	Name	Description	Default (Range)
F7-79 (0793)	PZD10 Read	<p>V/f CL-V/f OLV CLV AOLV OLV/PM AOLV/PM CLV/PM EZOLV</p> <p>When you use a Profibus option, sets the MEMOBUS/Modbus address for PZD10 (PPO input). A value of 0 will disable the PZD10 (PPO input) load operation from the MEMOBUS/Modbus register.</p>	0

12.8 H: Terminal Functions

H parameters are used to assign functions to external input and output terminals.

◆ H1: Digital Inputs

H1 Parameters set the MFDI terminal functions.

■ H1-01 to H1-08 Terminal S1 to S8 Function Selection

The drive has 8 MFDI terminals. Refer to [Table 12.60](#) for drive default settings and functions.

Table 12.60 MFDI Default Settings and Functions

No.	Name	Default	Function
H1-01	Terminal S1 Function Selection	40 (F) <i>*I</i>	Forward RUN (2-Wire)
H1-02	Terminal S2 Function Selection	41 (F) <i>*I</i>	Reverse RUN (2-Wire)
H1-03	Terminal S3 Function Selection	24	External Fault (NO-Always-Coast)
H1-04	Terminal S4 Function Selection	14	Fault Reset
H1-05	Terminal S5 Function Selection	3 (0) <i>*I</i>	Multi-Step Speed Reference 1
H1-06	Terminal S6 Function Selection	4 (3) <i>*I</i>	Multi-Step Speed Reference 2
H1-07	Terminal S7 Function Selection	6 (4) <i>*I</i>	Jog Reference Selection
H1-08	Terminal S8 Function Selection	8	Baseblock Command (N.O.)

*1 The value in parentheses identifies the default setting when you set $A1-03 = 3330$ [Initialize Parameters = 3-Wire Initialization]. Refer to the [Table 12.61](#) and use *H1-xx* [MFDI Function Select] to set the function.

Table 12.61 MFDI Setting Values

Setting Value	Function	Ref.	Setting Value	Function	Ref.
0 <i>*I</i>	3-Wire Sequence	842	19	PID Disable	850
1	LOCAL/REMOTE Selection	843	1A	Accel/Decel Time Selection 2	850
2	External Reference 1/2 Selection	843	1B	Programming Lockout	850
3	Multi-Step Speed Reference 1	843	1E	Reference Sample Hold	851
4	Multi-Step Speed Reference 2	843	20 to 2F <i>*I</i>	External Fault	851
5	Multi-Step Speed Reference 3	844	30	PID Integrator Reset	852
6	Jog Reference Selection	844	31	PID Integrator Hold	852
7	Accel/Decel Time Selection 1	844	32	Multi-Step Speed Reference 4	852
8 <i>*I</i>	Baseblock Command (N.O.)	844	34	PID Soft Starter Disable	852
9 <i>*I</i>	Baseblock Command (N.C.)	844	35	PID Input (Error) Invert	853
A	Accel/Decel Ramp Hold	845	3E	PID Setpoint Selection 1	853
B	Overheat Alarm (oH2)	845	3F	PID Setpoint Selection 2	853
C	Analog Terminal Enable Selection	845	40 <i>*I</i>	Forward RUN (2-Wire)	853
D	Ignore Speed Fdbk (V/f w/o Enc)	845	41 <i>*I</i>	Reverse RUN (2-Wire)	853
E	ASR Integral Reset	845	42 <i>*I</i>	Run Command (2-Wire Sequence 2)	854
F	Not Used	845	43 <i>*I</i>	FWD/REV (2-Wire Sequence 2)	854
10	Up Command	846	44	Add Offset Frequency 1 (d7-03)	854
11	Down Command	847	45	Add Offset Frequency 2 (d7-03)	854
12 <i>*I</i>	Forward Jog	848	46	Add Offset Frequency 3 (d7-03)	854
13 <i>*I</i>	Reverse Jog	848	47	Node Setup (CANopen)	854
14	Fault Reset	848	60	DC Injection Braking Command	855
15 <i>*I</i>	Fast Stop (N.O.)	848	61	Speed Search from Fmax	855
16	Motor 2 Selection	849	62	Speed Search from Fref	855
17 <i>*I</i>	Fast Stop (N.C.)	849	63	Field Weakening	855
18	Timer Function	850	65 <i>*I</i>	KEB Ride-Thru 1 Activate (N.C.)	855

Setting Value	Function	Ref.	Setting Value	Function	Ref.
66 */	KEB Ride-Thru 1 Activate (N.O.)	856	7B */	KEB Ride-Thru 2 Activate (N.O.)	859
67	Communications Test Mode	856	7C */	Short Circuit Braking (N.O.)	859
68	High Slip Braking (HSB) Activate	856	7D */	Short Circuit Braking (N.C.)	860
6A	Drive Enable	856	7E	Reverse Rotation Identifier	860
71	Torque Control	856	7F	PID Bi-Directional Enable	860
72	Zero Servo	857	90 to 97 */	DWEZ Digital Inputs 1 to 8	860
75	Up 2 Command	857	9F	DWEZ Disable	860
76	Down 2 Command	858	101 - 19F	Inverse Inputs of 1 to 9F Sets the function of the selected MFDI to operate inversely. To select the function for inverse input, enter two digits 01 to 9F for the "xx" in "1xx".	861
77	ASR Gain (C5-03) Select	859			
78	Analog TorqueRef Polarity Invert	859			
7A */	KEB Ride-Thru 2 Activate (N.C.)	859			

*1 Inverse input is not available.

MEMOBUS/Modbus MFDI 1 to 3 Function Selection

You can set the function for the MFDI to MEMOBUS register *bit 0 to 2 of [15C0 (Hex.)]*. Use *H1-40 to H1-42 [Extend MFDI Function Selection]* to select the function.

Note:

- Refer to H1-xx "MFDI setting values" for the setting values of the MFDI.
- You cannot set values 0 [3-Wire Sequence] and 20 to 2F [External Fault] for H1-40 to H1-42.
- When you will not use H1-40 to H1-42, set them to F [Not Used].
- You cannot set MFDI for digital input option DI-A3 at the same time as function selection for MEMOBUS/Modbus MFDI 1 to 3.

H1-01: Terminal S1 Function Selection

No. (Hex.)	Name	Description	Default (Range)
H1-01 (0438)	Terminal S1 Function Selection	V/f CL-V/f OLV CLV AOLV OLV/PM AOLV/PM CLV/PM EZOLV Sets the function for MFDI terminal S1.	40 (1 - 1FF)

Note:

The default setting is F when you initialize the drive for 3-Wire Initialization [A1-03 = 3330].

H1-02: Terminal S2 Function Selection

No. (Hex.)	Name	Description	Default (Range)
H1-02 (0439)	Terminal S2 Function Selection	V/f CL-V/f OLV CLV AOLV OLV/PM AOLV/PM CLV/PM EZOLV Sets the function for MFDI terminal S2.	41 (1 - 1FF)

Note:

The default setting is F when you initialize the drive for 3-Wire Initialization [A1-03 = 3330].

H1-03: Terminal S3 Function Selection

No. (Hex.)	Name	Description	Default (Range)
H1-03 (0400)	Terminal S3 Function Selection	V/f CL-V/f OLV CLV AOLV OLV/PM AOLV/PM CLV/PM EZOLV Sets the function for MFDI terminal S3.	24 (0 - 1FF)

H1-04: Terminal S4 Function Selection

No. (Hex.)	Name	Description	Default (Range)
H1-04 (0401)	Terminal S4 Function Selection	V/f CL-V/f OLV CLV AOLV OLV/PM AOLV/PM CLV/PM EZOLV Sets the function for MFDI terminal S4.	14 (0 - 1FF)

■ **H1-05: Terminal S5 Function Selection**

No. (Hex.)	Name	Description	Default (Range)
H1-05 (0402)	Terminal S5 Function Selection	V/f CL-V/f OLV CLV AOLV OLV/PM AOLV/PM CLV/PM EZOLV Sets the function for MFDI terminal S5.	3 (0 - 1FF)

Note:

The default setting is 0 when the drive is initialized for 3-Wire Initialization [A1-03 = 3330].

■ **H1-06: Terminal S6 Function Selection**

No. (Hex.)	Name	Description	Default (Range)
H1-06 (0403)	Terminal S6 Function Selection	V/f CL-V/f OLV CLV AOLV OLV/PM AOLV/PM CLV/PM EZOLV Sets the function for MFDI terminal S6.	4 (0 - 1FF)

Note:

The default setting is 3 when the drive is initialized for 3-Wire Initialization [A1-03 = 3330].

■ **H1-07: Terminal S7 Function Selection**

No. (Hex.)	Name	Description	Default (Range)
H1-07 (0404)	Terminal S7 Function Selection	V/f CL-V/f OLV CLV AOLV OLV/PM AOLV/PM CLV/PM EZOLV Sets the function for MFDI terminal S7.	6 (0 - 1FF)

Note:

The default setting is 4 when the drive is initialized for 3-Wire Initialization [A1-03 = 3330].

■ **H1-08: Terminal S8 Function Selection**

No. (Hex.)	Name	Description	Default (Range)
H1-08 (0405)	Terminal S8 Function Selection	V/f CL-V/f OLV CLV AOLV OLV/PM AOLV/PM CLV/PM EZOLV Sets the function for MFDI terminal S8.	8 (0 - 1FF)

■ **H1-21: Terminal S1 Function Select 2**

No. (Hex.)	Name	Description	Default (Range)
H1-21 (0B70)	Terminal S1 Function Selection 2	V/f CL-V/f OLV CLV AOLV OLV/PM AOLV/PM CLV/PM EZOLV Sets the second function for MFDI terminal S1.	F (1 - 19F)

When MFDI terminal S1 activates, it will operate the function set to H1-01 [Terminal S1 Function Selection] and the function set to H1-21 at the same time.

When the setting value is F, the function is disabled.

■ **H1-22: Terminal S2 Function Select 2**

No. (Hex.)	Name	Description	Default (Range)
H1-22 (0B71)	Terminal S2 Function Select 2	V/f CL-V/f OLV CLV AOLV OLV/PM AOLV/PM CLV/PM EZOLV Sets the second function for MFDI terminal S2.	F (1 - 19F)

When MFDI terminal S2 activates, it will operate the function set to H1-02 [Terminal S2 Function Selection] and the function set to H1-22 at the same time.

When the setting value is F, the function is disabled.

■ **H1-23: Terminal S3 Function Select 2**

No. (Hex.)	Name	Description	Default (Range)
H1-23 (0B72)	Terminal S3 Function Selection 2	V/f CL-V/f OLV CLV AOLV OLV/PM AOLV/PM CLV/PM EZOLV Sets the second function for MFDI terminal S3.	F (1 - 19F)

When MFDI terminal S3 activates, it will operate the function set to H1-03 [Terminal S3 Function Selection] and the function set to H1-23 at the same time.

When the setting value is *F*, the function is disabled.

■ H1-24: Terminal S4 Function Selection 2

No. (Hex.)	Name	Description	Default (Range)
H1-24 (0B73)	Terminal S4 Function Selection 2	V/f CL-V/f OLV CLV AOLV OLV/PM AOLV/PM CLV/PM EZOLV Sets the second function for MFDI terminal S4.	F (1 - 19F)

When MFDI terminal S4 activates, it will operate the function set to *H1-04* [Terminal S4 Function Selection] and the function set to *H1-24* at the same time.

When the setting value is *F*, the function is disabled.

■ H1-25: Terminal S5 Function Select 2

No. (Hex.)	Name	Description	Default (Range)
H1-25 (0B74)	Terminal S5 Function Selection 2	V/f CL-V/f OLV CLV AOLV OLV/PM AOLV/PM CLV/PM EZOLV Sets the second function for MFDI terminal S5.	F (1 - 19F)

When MFDI terminal S5 activates, it will operate the function set to *H1-05* [Terminal S5 Function Selection] and the function set to *H1-25* at the same time.

When the setting value is *F*, the function is disabled.

■ H1-26: Terminal S6 Function Select 2

No. (Hex.)	Name	Description	Default (Range)
H1-26 (0B75)	Terminal S6 Function Selection 2	V/f CL-V/f OLV CLV AOLV OLV/PM AOLV/PM CLV/PM EZOLV Sets the second function for MFDI terminal S6.	F (1 - 19F)

When MFDI terminal S6 activates, it will operate the function set to *H1-06* [Terminal S6 Function Selection] and the function set to *H1-26* at the same time.

When the setting value is *F*, the function is disabled.

■ H1-27: Terminal S7 Function Select 2

No. (Hex.)	Name	Description	Default (Range)
H1-27 (0B76)	Terminal S7 Function Selection 2	V/f CL-V/f OLV CLV AOLV OLV/PM AOLV/PM CLV/PM EZOLV Sets the second function for MFDI terminal S7.	F (1 - 19F)

When MFDI terminal S7 activates, it will operate the function set to *H1-07* [Terminal S7 Function Selection] and the function set to *H1-27* at the same time.

When the setting value is *F*, the function is disabled.

■ H1-28: Terminal S8 Function Select 2

No. (Hex.)	Name	Description	Default (Range)
H1-28 (0B77)	Terminal S8 Function Selection 2	V/f CL-V/f OLV CLV AOLV OLV/PM AOLV/PM CLV/PM EZOLV Sets the second function for MFDI terminal S8.	F (1 - 19F)

When MFDI terminal S8 activates, it will operate the function set to *H1-08* [Terminal S8 Function Selection] and the function set to *H1-28* at the same time.

When the setting value is *F*, the function is disabled.

■ H1-40: Mbus Reg 15C0h bit0 Input Func

No. (Hex.)	Name	Description	Default (Range)
H1-40 (0B54)	Mbus Reg 15C0h bit0 Input Func	V/f CL-V/f OLV CLV AOLV OLV/PM AOLV/PM CLV/PM EZOLV Sets MFDI function to set to <i>bit 0</i> of the MEMOBUS register <i>15C0</i> (Hex.).	F (1 - 19F)

■ H1-41: Mbus Reg 15C0h bit1 Input Func

No. (Hex.)	Name	Description	Default (Range)
H1-41 (0B55)	Mbus Reg 15C0h bit1 Input Func	V/f CL-V/f OLV CLV AOLV OLV/PM AOLV/PM CLV/PM EZOLV Sets MFDI function to set to bit 1 of the MEMOBUS register 15C0 (Hex.).	F (1 - 19F)

■ H1-42: Mbus Reg 15C0h bit2 Input Func

No. (Hex.)	Name	Description	Default (Range)
H1-42 (0B56)	Mbus Reg 15C0h bit2 Input Func	V/f CL-V/f OLV CLV AOLV OLV/PM AOLV/PM CLV/PM EZOLV Sets MFDI function to set to bit 2 of the MEMOBUS register 15C0 (Hex.).	F (1 - 19F)

◆ Multi-Function Digital Input Setting Values

Selects a function set with H1-01 to H1-08.

■ 0: 3-Wire Sequence

Setting Value	Function	Description
0	3-Wire Sequence	V/f CL-V/f OLV CLV AOLV OLV/PM AOLV/PM CLV/PM EZOLV Sets the direction of motor rotation for 3-wire sequence.

If the 3-wire sequence is set to a terminal that is not MFDI terminals S1 and S2, these terminals will be the input terminals for Forward run/Reverse run command. The drive will automatically set terminal S1 to Run command (RUN) and terminal S2 to Stop command (STOP).

When terminal S1 (Run command) activates for 1 ms minimum, the drive rotates the motor. When terminal S2 (Stop command) deactivates, the drive stops. When terminal Sx that is set in 3-wire sequence deactivates, the drive operates in the forward direction, and when it activates, the drive operates in the reverse direction.

WARNING! Sudden Movement Hazard. Set the MFDI parameters before you close control circuit switches. Incorrect Run/Stop circuit sequence settings can cause serious injury or death from moving equipment.

WARNING! Sudden Movement Hazard. When you use a 3-Wire sequence, set A1-03 = 3330 [Initialize Parameters = 3-Wire Initialization] and make sure that b1-17 = 0 [Run Command at Power Up = Disregard Existing RUN Command] (default). If you do not correctly set the drive parameters for 3-Wire operation before you energize the drive, the motor can suddenly rotate when you energize the drive.

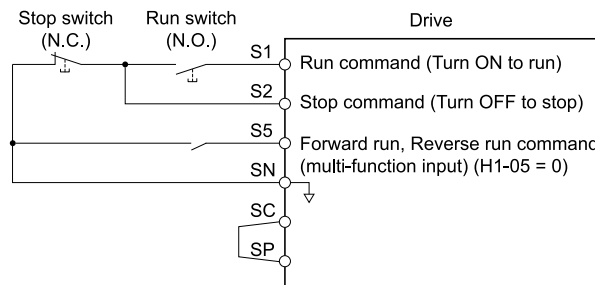

Figure 12.80 3-Wire Sequence Wiring Example

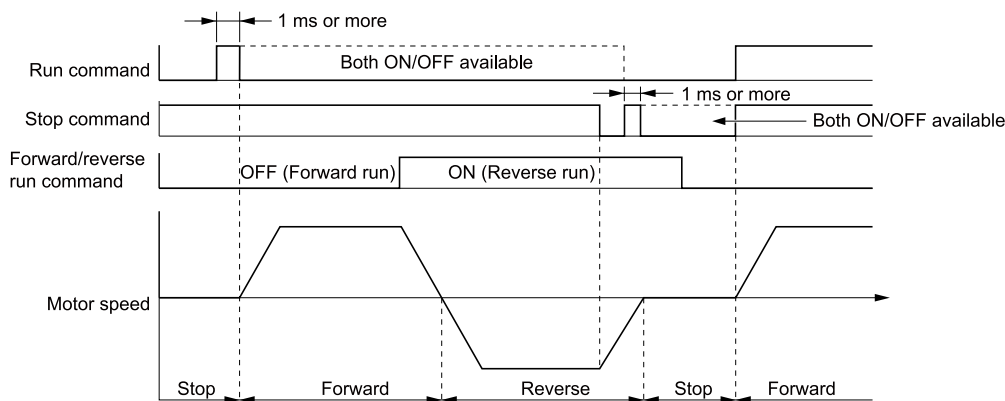











Figure 12.81 3-Wire Sequence Time Chart



Note:

- To input the Run command, activate the terminal for 1 ms minimum.
- The default setting for *b1-17 [Run Command at Power Up]* is 0 [Disregard existing RUN command]. If you enable the Run command on an energized drive, the protective function activates and the  flashes quickly. When the application will let an energized drive Run, set *b1-17 = 1 [Accept Existing RUN Command]*.

1: LOCAL/REMOTE Selection

Setting Value	Function	Description
1	LOCAL/REMOTE Selection	         Sets drive control for the keypad (LOCAL) or an external source (REMOTE).

Note:

- When the MFDI terminal sets the LOCAL/REMOTE selection,  on the keypad is disabled.
- When LOCAL Mode is selected, the green light for  comes on.
- When the Run command is ON, you cannot switch between LOCAL Mode and REMOTE Mode.









ON : LOCAL

The keypad is the Frequency reference source and Run command source.

OFF : REMOTE

The frequency reference and Run command settings are set in *b1-01, b1-02 [Frequency Reference Selection 1/2]* or *b1-15, b1-16 [Run Command Selection 1/2]*.

2: External Reference 1/2 Selection

Setting Value	Function	Description
2	External Reference 1/2 Selection	         Sets the drive to use Run command source 1/2 or Reference command source 1/2 when in REMOTE Mode.

Note:

The ability to switch the Run command source and frequency reference source depends on the setting of *b1-07 [LOCAL/REMOTE Run Selection]*.









Table 12.62 Ability to Switch the Run Command Source and Frequency Reference Source when Inputting the Run Command

<i>b1-07</i>	Run command source	Frequency reference source
0 [Disregard Existing RUN Command] (Default)	No	Yes
1 [Accept Existing RUN Command]	Yes	Yes

ON : *b1-15 [Frequency Reference Selection 2], b1-16 [Run Command Selection 2]*

OFF : *b1-01 [Frequency Reference Selection 1], b1-02 [Run Command Selection 1]*









3: Multi-Step Speed Reference 1

Setting Value	Function	Description
3	Multi-Step Speed Reference 1	         Uses speed references <i>d1-01 to d1-16</i> to set a multi-step speed reference.

Note:

Refer to [Setting Procedures for Multi-step Speed Operation on page 756](#) for more information.

4: Multi-Step Speed Reference 2

Setting Value	Function	Description
4	Multi-Step Speed Reference 2	         Uses speed references <i>d1-01 to d1-16</i> to set a multi-step speed reference.

Note:

Refer to [Setting Procedures for Multi-step Speed Operation on page 756](#) for more information.

5: Multi-Step Speed Reference 3

Setting Value	Function	Description
5	Multi-Step Speed Reference 3	V/f CL-V/f OLV CLV AOLV OLV/PM AOLV/PM CLV/PM EZOLV Uses speed references <i>d1-01</i> to <i>d1-16</i> to set a multi-step speed reference.

Note:

Refer to [Setting Procedures for Multi-step Speed Operation on page 756](#) for more information.

6: Jog Reference Selection

Setting Value	Function	Description
6	Jog Reference Selection	V/f CL-V/f OLV CLV AOLV OLV/PM AOLV/PM CLV/PM EZOLV Sets the drive to use the JOG Frequency Reference (JOG command) set in <i>d1-17</i> . The JOG Frequency Reference (JOG command) overrides <i>Frequency References 1 to 16 (d1-01 to d1-16)</i> .

7: Accel/Decel Time Selection 1

Setting Value	Function	Description
7	Accel/Decel Time Selection 1	V/f CL-V/f OLV CLV AOLV OLV/PM AOLV/PM CLV/PM EZOLV Sets the drive to use <i>C1-01 [Acceleration Time 1]</i> and <i>C1-02 [Deceleration Time 1]</i> or <i>C1-03 [Acceleration Time 2]</i> and <i>C1-04 [Deceleration Time 2]</i> .

Note:

Refer to [C1: Accel & Decel Time on page 731](#) for more information.

8: Baseblock Command (N.O.)

Setting Value	Function	Description
8	Baseblock Command (N.O.)	V/f CL-V/f OLV CLV AOLV OLV/PM AOLV/PM CLV/PM EZOLV Sets the command that stops drive output and coasts the motor to stop when the input is ON.

WARNING! Sudden Movement Hazard. When you use a mechanical holding brake with the drive in a lifting application, you must close the brake if an input terminal triggers the Baseblock command to stop drive output. If you enter the baseblock command, the motor will suddenly coast and the load will slip, which can cause serious injury or death.

WARNING! Incorrect Operation. Yaskawa recommends that you use *H1-xx = 9 [Baseblock Command (N.C.)]*. If a circuit error occurs in the MFDI, the drive cannot stop the output when the terminal set to *H1-xx = 8 [Baseblock Command (N.O.)]* turns ON.

The keypad flashes *bb [Baseblock]*. If you cancel the baseblock command when the Run command is active, the drive will restart the motor and use the speed search function.

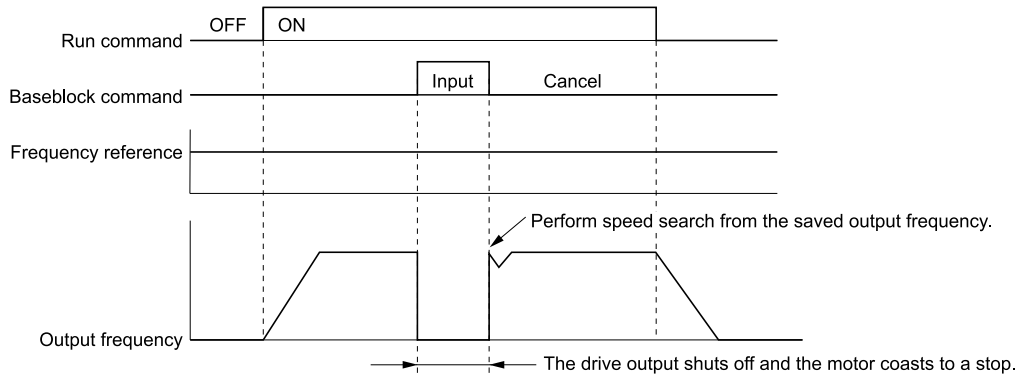

Figure 12.82 Baseblock Command Time Chart

ON : Baseblock (drive output stop)

OFF : Normal operation

9: Baseblock Command (N.C.)

Setting Value	Function	Description
9	Baseblock Command (N.C.)	V/f CL-V/f OLV CLV AOLV OLV/PM AOLV/PM CLV/PM EZOLV Sets the command that stops drive output and coasts the motor to stop when the input terminal is OFF.

The keypad flashes *bb [Baseblock]*. If you cancel the baseblock command when the Run command is active, the drive will restart the motor and use the speed search function.

ON : Normal operation

OFF : Baseblock (drive output stop)

WARNING! Sudden Movement Hazard. When you use a mechanical holding brake with the drive in a lifting application, you must close the brake if an input terminal triggers the Baseblock command to stop drive output. If you enter the baseblock command, the motor will suddenly coast and the load will slip, which can cause serious injury or death.

■ A: Accel/Decel Ramp Hold

Setting Value	Function	Description
A	Accel/Decel Ramp Hold	<div style="display: flex; justify-content: space-between; align-items: center;"> V/f CL-V/f OLV CLV AOLV OLV/PM AOLV/PM CLV/PM EZOLV </div> <p>Momentarily pauses motor acceleration and deceleration when the terminal is turned ON, retains the output frequency that was stored in the drive at the time of the pause, and restarts motor operation.</p>

If the terminal is deactivated, the drive restarts acceleration and deceleration.

When the acceleration/deceleration ramp hold terminal is activated and $d4-01 = 1$ [*Freq Reference Retention Select = Enabled*], the drive will store the output frequency in memory. While the acceleration/deceleration ramp hold command is activated, the drive will always restart the motor at this output frequency.

Note:

Refer to *d4-01: Freq Reference Hold Selection on page 764* for more information.

■ B: Overheat Alarm (oH2)

Setting Value	Function	Description
B	Overheat Alarm (oH2)	<div style="display: flex; justify-content: space-between; align-items: center;"> V/f CL-V/f OLV CLV AOLV OLV/PM AOLV/PM CLV/PM EZOLV </div> <p>Sets the drive to show an oH2 [<i>External Overheat (H1-XX=B)</i>] alarm when the input terminal is ON. The alarm does not have an effect on drive operation.</p>

■ C: Analog Terminal Enable Selection

Setting Value	Function	Description
C	Analog Terminal Enable Selection	<div style="display: flex; justify-content: space-between; align-items: center;"> V/f CL-V/f OLV CLV AOLV OLV/PM AOLV/PM CLV/PM EZOLV </div> <p>Sets the command that enables or disables the terminals selected in H3-14 [<i>Analog Input Terminal Enable Sel</i>].</p>

ON : Terminal selected with H3-14 is enabled

OFF : Terminal selected with H3-14 is disabled

■ D: Ignore Speed Fdbk (V/f w/o Enc)

Setting Value	Function	Description
D	Ignore Speed Fdbk (V/f w/o Enc)	<div style="display: flex; justify-content: space-between; align-items: center;"> V/f CL-V/f OLV CLV AOLV OLV/PM AOLV/PM CLV/PM EZOLV </div> <p>Sets the command to disable speed feedback control and run the drive in V/f control or use speed feedback from the encoder.</p>

ON : Speed feedback control disable (V/f Control)

OFF : Speed feedback control enable (Closed Loop V/f Control)

■ E: ASR Integral Reset

Setting Value	Function	Description
E	ASR Integral Reset	<div style="display: flex; justify-content: space-between; align-items: center;"> V/f CL-V/f OLV CLV AOLV OLV/PM AOLV/PM CLV/PM EZOLV </div> <p>Sets the command to reset the integral value and use PI control or P control for the speed control loop.</p>

ON : P control

OFF : PI control

■ F: Not Used

Setting Value	Function	Description
F	Not Used	<div style="display: flex; justify-content: space-between; align-items: center;"> V/f CL-V/f OLV CLV AOLV OLV/PM AOLV/PM CLV/PM EZOLV </div> <p>Use this setting for unused terminals or to use terminals in through mode.</p>

Through Mode uses the signal input to the terminal as a digital input for the upper sequence through a communication option or MEMOBUS/Modbus communications. This input signal does not have an effect on drive operation.

■ 10: Up Command

Setting Value	Function	Description
10	Up Command	<div style="display: flex; justify-content: space-between; font-size: small;"> V/f CL-V/f OLV CLV AOLV OLV/PM AOLV/PM CLV/PM EZOLV </div> <p>Sets the command to use a push button switch to increase the drive frequency reference. You must also set <i>Setting 11 [Down Command]</i>.</p>

ON : Increases the frequency reference.

OFF : Holds the current frequency reference.

Note:

- If you set only the Up command or only the Down command, the drive will detect *oPE03 [Multi-Function Input Setting Err]*.
- If you set two or more of these functions at the same time, the drive will detect *oPE03*:
 - Up/Down command
 - Accel/Decel Ramp Hold
 - Reference Sample Hold
 - Offset Frequency 1, 2, 3 addition
 - Up/Down 2 Command
- The Up/Down command does not function in these conditions:
 - b1-01 = 2, 3 [Frequency Reference Selection 1 = Memobus/Modbus Communications, Option PCB]*
 - b1-02 ≠ 1 [Run Command Selection 1 ≠ Control Circuit Terminal]*
 - Drive is in LOCAL mode
 - Set to *b1-15 [Frequency Reference Selection 2]* by use of *H1-xx = 2 [MFDI Function Select = External Reference 1/2 Selection]*

When you enter the UP command, the frequency reference increases.

The Up and Down commands have priority over all other frequency references. When you enable the Up/Down command, the drive will ignore these frequency references:

- Frequency reference from Keypad [*b1-01 = 0*]
- Frequency reference from Analog Input [*b1-01 = 1*]
- Frequency reference from Pulse Train Input [*b1-01 = 4*]

Table 12.63 shows the Up and Down commands with their operation.

Table 12.63 Up Command and Down Command

Command status		Drive operation
Up command (10)	Down command (11)	
OFF	OFF	Keeps the current frequency reference.
ON	OFF	Increases the frequency reference.
OFF	ON	Decreases the frequency reference.
ON	ON	Keeps the current frequency reference.

Combine Frequency Reference Hold Functions and Up/Down Commands

- When you clear the Run command or when *d4-01 = 0 [Freq Reference Hold Selection = Disabled]*, and you restart the drive, the Up/Down command resets to 0.
- When *d4-01 = 1 [Enabled]*, the drive saves the frequency reference set during the Up/Down command. When you cycle the Run command or restart the drive, the drive saves the frequency reference value and restarts the motor at this frequency value. After you clear the Run command, activate the terminal set for the Up command or Down command to set the saved reference value to 0.

Note:

Refer to *d4-01: Freq Reference Hold Selection on page 764* for more information.

Combine Upper/Lower Limits of the Frequency Reference and the Up/Down Commands

Set the upper limit value of the frequency reference to *d2-01 [Frequency Reference Upper Limit]*.

Use an analog input or *d2-02 [Frequency Reference Lower Limit]* to set the lower limit value of the frequency reference. The configurable values change when the setting for *d4-10 [Up/Down Freq Lower Limit Select]* changes. When you input a Run command, these are the lower limits of the frequency reference:

- When the lower limit of the frequency reference is set only for *d2-02*, the drive accelerates the motor to the lower limit value of the frequency reference at the same time that you input the Run command.
- When the lower limit of the frequency reference is set only for analog input, the drive accelerates the motor to the lower limit value of the frequency reference when the Run command, and Up command or Down command for the drive is enabled. When only the Run command is enabled, the motor does not start.

- When these conditions occur, the drive accelerates the motor to the $d2-02$ setting value when the Run command is input. When the motor accelerates to the setting value of $d2-02$, if the Up/Down command is enabled, the motor accelerates to the lower limit value of the analog input.
 - The lower limit value of the frequency reference is set for the analog input and $d2-02$
 - The lower limit value of the analog input is higher than the setting value of $d2-02$

Note:

Refer to $d4-01$: *Freq Reference Hold Selection on page 764* for more information.

Figure 12.83 shows an example of how Up/Down command operates. In this example, the lower limit value of the frequency reference is set in $d2-02$. Figure 12.83 shows the time chart when Freq Reference Retention Select [$d4-01$] is enabled and disabled.

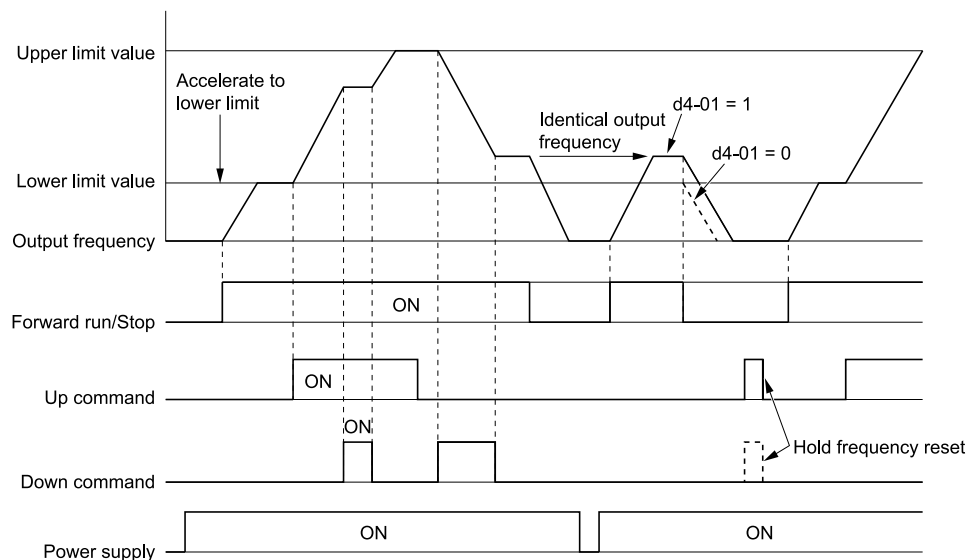

Figure 12.83 Up/Down Command Time Chart

■ 11: Down Command

Setting Value	Function	Description
11	Down Command	<div style="display: flex; gap: 5px;"> V/f CL-V/f OLV CLV AOLV OLV/PM AOLV/PM CLV/PM EZOLV </div> <p>Sets the command to use a push button switch to decrease the drive frequency reference. You must also set <i>Setting 10 [Up Command]</i>.</p>

ON : Decreases the frequency reference.

OFF : Holds the current frequency reference.

Note:

- If you set only the Up command or only the Down command, the drive will detect $oPE03$ [*Multi-Function Input Setting Err*].
- If you set two or more of these functions at the same time, the drive will detect $oPE03$:
 - Up/Down command
 - Accel/Decel Ramp Hold
 - Reference Sample Hold
 - Offset Frequency 1, 2, 3 addition
 - Up/Down 2 Command
- The Up/Down command does not function in these conditions:
 - $b1-01 = 2, 3$ [*Frequency Reference Selection 1 = Memobus/Modbus Communications, Option PCB*]
 - $b1-02 \neq 1$ [*Run Command Selection 1 \neq Control Circuit Terminal*]
 - Drive is in LOCAL mode
 - Set to $b1-15$ [*Frequency Reference Selection 2*] by use of $H1-xx = 2$ [*MFDI Function Select = External Reference 1/2 Selection*]

When you enter the UP command, the frequency reference increases. When you enter the Down command, the frequency reference decreases.

The Up and Down commands have priority over all other frequency references. When you enable the Up/Down command, the drive will ignore these frequency references:

- Frequency reference from Keypad [$b1-01 = 0$]
- Frequency reference from Analog Input [$b1-01 = 1$]

- Frequency reference from Pulse Train Input [$b1-01 = 4$]

12: Forward Jog

Setting Value	Function	Description
12	Forward Jog	V/f CL-V/f OLV CLV AOLV OLV/PM AOLV/PM CLV/PM EZOLV Sets the command to operate the motor in the forward direction at the Jog Frequency set in $d1-17$ [Jog Reference].

Note:

- It is not necessary to input the Run command.
- The Forward JOG command has priority over all other frequency references.
- When the Forward JOG and Reverse JOG commands are activated at the same time for 500 ms or longer, the drive will ramp to stop.

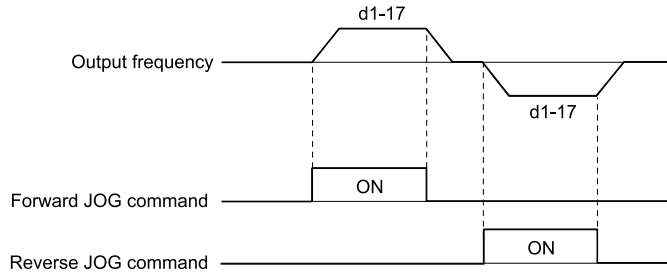

Figure 12.84 JOG Operation Pattern

13: Reverse Jog

Setting Value	Function	Description
13	Reverse Jog	V/f CL-V/f OLV CLV AOLV OLV/PM AOLV/PM CLV/PM EZOLV Sets the command to operate the motor in the reverse direction at the Jog Frequency set in $d1-17$ [Jog Reference].

Note:

- It is not necessary to input the Run command.
- The Reverse JOG command has priority over all other frequency references.
- When the Forward JOG and Reverse JOG commands are activated at the same time for 500 ms or longer, the drive will ramp to stop.

14: Fault Reset

Setting Value	Function	Description
14	Fault Reset	V/f CL-V/f OLV CLV AOLV OLV/PM AOLV/PM CLV/PM EZOLV Sets the command to reset the current fault when the Run command is inactive.

If the drive detects a fault, the drive will activate the fault relay output, turn off the output, and the motor will coast to stop.

If the drive detects a fault for which you can set the stopping method, apply the appropriate Stopping Method.

Then push  (RESET) on the keypad to turn the Run command OFF, or activate the fault reset terminal to reset the fault.

Note:

The drive ignores the fault reset command when the Run command is active. Remove the Run command before trying to reset a fault.

15: Fast Stop (N.O.)

Setting Value	Function	Description
15	Fast Stop (N.O.)	V/f CL-V/f OLV CLV AOLV OLV/PM AOLV/PM CLV/PM EZOLV Sets the command to ramp to stop in the deceleration time set in $C1-09$ [Fast Stop Time] when the input terminal is ON while the drive is operating.

WARNING! Incorrect Operation. Yaskawa recommends that you use $H1-xx = 17$ [Fast Stop (N.C.)]. If a circuit error occurs in the MFDI, the drive cannot stop the output when the terminal set to $H1-xx = 15$ [Fast Stop (N.O.)] turns ON.

If you cancel the fast stop input, the drive will not restart the motor until you meet these conditions:

- Fully stop the motor
- Cancel the Run command
- Cancel the fast stop command

Note:

- To use the N.C. switch to input the fast stop command, set $H1-xx = 17$ [*Fast Stop (N.C.)*].
- Refer to [C1-09: Fast Stop Time on page 734](#) for more information.
- Set $C1-09$ [*Fast Stop Time*] to a correct deceleration time. If the deceleration time is too short, it can cause an overvoltage fault, which will not stop the motor from coasting.

■ 16: Motor 2 Selection

Setting Value	Function	Description
16	Motor 2 Selection	<div style="display: flex; justify-content: space-between; font-size: small;"> V/f CL-V/f OLV CLV AOLV OLV/PM AOLV/PM CLV/PM EZOLV </div> Sets the command for the drive to operate motor 1 or motor 2. Stop the motors before switching.

You can use an external input to switch operation between two induction motors. The drive will save the control methods, V/f patterns, and motor parameters for the two motors.

ON : Selects motor 2

OFF : Selects motor 1

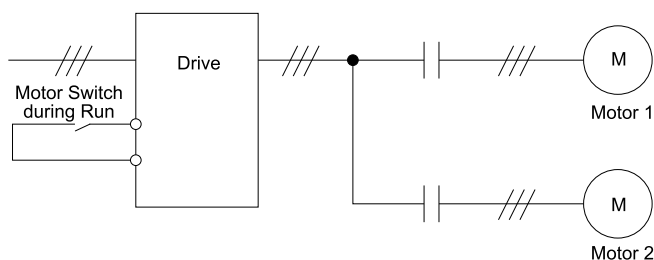

When you select motor 2, the drive will switch to motor 2 parameters.

Table 12.64 Parameters that Switch between Motor 1 and Motor 2

Parameter	Motor 2 Selection	
	OFF (Motor 1)	ON (Motor 2)
C1-xx [Accel & Decel Time]	C1-01 to C1-04	C1-05 to C1-08
C3-xx [Slip Compensation]	C3-01 to C3-04	C3-21 to C3-24
C4-xx [Torque Compensation]	C4-01	C4-07
C5-xx [Automatic Speed Regulator (ASR)]	C5-01 to C5-08, C5-12, C5-17, C5-18	C5-21 to C5-28, C5-32, C5-37, C5-38
E1-xx, E3-xx [V/f Patterns] E2-xx, E4-xx [Motor Parameters]	E1-xx, E2-xx	E3-xx, E4-xx
F1-xx [Number of PG Pulses per Revolution]	F1-01 to F1-21	F1-02 to F1-04, F1-08 to F1-11, F1-14, F1-31 to F1-37

Note:

- When you use 2 motors, the drive applies the protective function set in $L1-01$ [*Motor Overload (oL1) Protection*] to motor 1 and motor 2.
- You cannot switch between motors 1 and 2 during run. If you try to switch motors when they are running, it will cause a rUn [*Motor Switch during Run*] error.
- After you switch between encoder motors, you must wait 500 ms minimum to input a Run command. You must wait 200 ms minimum for other control methods.
- If you set $H1-xx = 16$ [*Motor 2 Selection*] and set different control methods in maximum output frequency to motors 1 and 2, the drive will apply the lower of the two maximum to the two motors. The upper limit of $d1-xx$ [*Frequency Reference*] will change. For example, the upper limit of $d1-xx$ will be 400 when you set these parameters to these values:
 - A1-02 = 2 [Control Method Selection = OLV]
 - E1-04 = 590 [Maximum Output Frequency = 590 Hz]
 - E3-01 = 3 [Motor 2 Control Mode Selection = CLV]
 - E3-04 = 400 [Motor 2 Maximum Output Frequency = 400 Hz]

■ 17: Fast Stop (N.C.)

Setting Value	Function	Description
17	Fast Stop (N.C.)	<div style="display: flex; justify-content: space-between; font-size: small;"> V/f CL-V/f OLV CLV AOLV OLV/PM AOLV/PM CLV/PM EZOLV </div> Sets the command to ramp to stop in the deceleration time set in $C1-09$ [<i>Fast Stop Time</i>] when the input terminal is ON while the drive is operating.

If you cancel the fast stop input, the drive will not restart the motor until you meet these conditions:

- Fully stop the motor

- Cancel the Run command
- Cancel the fast stop command

Note:

- To use the N.O. switch to input the fast stop command, set 15 (Fast Stop (N.O.)).
- Refer to *C1-09: Fast Stop Time on page 734* for more information.
- Set *C1-09 [Fast Stop Time]* to a correct deceleration time. If the deceleration time is too short, it can cause an overvoltage fault and failure to stop the motor from coasting.

Figure 12.85 shows an example of how fast stop operates.

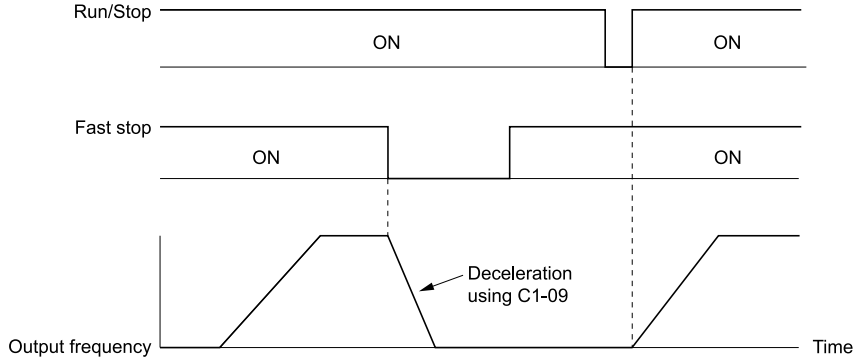

Figure 12.85 Fast Stop Time Chart

■ 18: Timer Function

Setting Value	Function	Description
18	Timer Function	V/f CL-V/f OLV CLV AOLV OLV/PM AOLV/PM CLV/PM EZOLV Sets the command to start the timer function. Use this setting with <i>Timer Output [H2-xx = 12]</i> .

Note:

Refer to “b4: Timer Function” for more information.

■ 19: PID Disable

Setting Value	Function	Description
19	PID Disable	V/f CL-V/f OLV CLV AOLV OLV/PM AOLV/PM CLV/PM EZOLV Sets the command to disable PID control when <i>b5-01 = 1 to 8 [PID Mode Setting = Enabled]</i> .

ON : PID control disabled

OFF : PID control enabled

■ 1A: Accel/Decel Time Selection 2

Setting Value	Function	Description
1A	Accel/Decel Time Selection 2	V/f CL-V/f OLV CLV AOLV OLV/PM AOLV/PM CLV/PM EZOLV Set this function and <i>H1-xx = 7 [Accel/Decel Time Selection 1]</i> together. Sets the drive to use <i>C1-05 [Acceleration Time 3]</i> and <i>C1-06 [Deceleration Time 3]</i> or <i>C1-07 [Acceleration Time 4]</i> and <i>C1-08 [Deceleration Time 4]</i> .

Note:

Refer to *C1: Accel & Decel Time on page 731* for more information.

■ 1B: Programming Lockout

Setting Value	Function	Description
1B	Programming Lockout	V/f CL-V/f OLV CLV AOLV OLV/PM AOLV/PM CLV/PM EZOLV Sets the command to prevent parameter changes when the terminal is OFF.

You can continue to view parameter setting values when the terminal is *OFF [Parameter Write Prohibit]*.

ON : Programming Lockout

OFF : Parameter Write Prohibit

■ 1E: Reference Sample Hold

Setting Value	Function	Description
1E	Reference Sample Hold	<div style="display: flex; justify-content: space-between; align-items: center;"> V/f CL-V/f OLV CLV AOLV OLV/PM AOLV/PM CLV/PM EZOLV </div> <p>Sets the command to sample the frequency reference at terminals A1, A2, or A3 and hold the frequency reference at that frequency.</p>

When the terminal is active for 100 ms, this function reads a sample of the analog frequency reference and holds that sample. When you input the sample/hold command again, the function reads a sample of the analog frequency reference again and holds that sample. When you turn off the power, the drive erases the saved analog frequency and resets the frequency reference to 0.

Figure 12.86 shows an example of how the function operates.

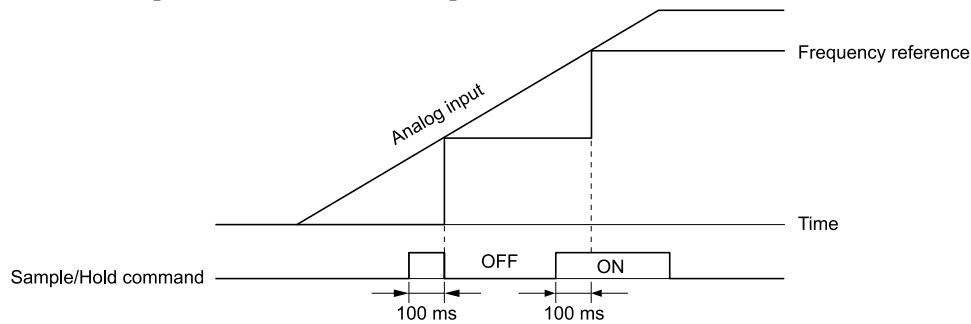

Figure 12.86 Reference Sample Hold

You cannot set the Reference Sample Hold function at the same time as these functions:

- $H1-xx = A$ [Accel/Decel Ramp Hold]
- $H1-xx = 10, 11$ [Up Command, Down Command]
- $H1-xx = 44$ to 46 [Offset Frequency 1 to 3]
- $H1-xx = 75, 76$ [Up 2 Command, Down 2 Command]

If you set them at the same time, the drive will detect $oPE03$ [Multi-Function Input Setting Err].

■ 20 to 2F: External Fault

Setting Value	Function	Description
20 to 2F	External Fault	<div style="display: flex; justify-content: space-between; align-items: center;"> V/f CL-V/f OLV CLV AOLV OLV/PM AOLV/PM CLV/PM EZOLV </div> <p>Sets a command to stop the drive when a failure or fault occurs on an external device.</p>

WARNING! Incorrect Operation. Yaskawa recommends that you use $H1-xx = 21, 23, 25, 27, 29, 2B, 2D, 2F$ [External Fault (N.C.)]. If a circuit error occurs in the MFDI, the drive cannot stop the output when the terminal set to $H1-xx = 20, 22, 24, 26, 28, 2A, 2C, 2E$ [External Fault (N.O.)] turns ON.

If an external fault is input to the drive, the keypad will show EFx [External Fault (Terminal Sx)], where x is the number of the terminal (terminal Sx) to which the external fault signal is assigned. For example, when an external fault signal is input to terminal $S3$, the keypad will show $EF3$ [External Fault (Terminal $S3$)].

Use these conditions to select the value to set in $H1-xx$:

- Signal input method from peripheral devices
- External fault detection method
- Motor stopping method (operation after external fault detection)

Table 12.65 shows the relation between the conditions and the value set to $H1-xx$.

Table 12.65 Stopping Methods for External Fault

Setting	Signal Input Method from Peripheral Devices ^{*1}		External Fault Detection Method ^{*2}		Stopping Method			
	N.O.	N.C.	Always Detected	Detected during RUN Only	Ramp to Stop (Fault)	Coast to Stop (Fault)	Fast Stop (Fault)	Continuous Operation (Alarm Only)
20	x	-	x	-	x	-	-	-
21	-	x	x	-	x	-	-	-
22	x	-	-	x	x	-	-	-
23	-	x	-	x	x	-	-	-
24	x	-	x	-	-	x	-	-

Setting	Signal Input Method from Peripheral Devices *1		External Fault Detection Method *2		Stopping Method			
	N.O.	N.C.	Always Detected	Detected during RUN Only	Ramp to Stop (Fault)	Coast to Stop (Fault)	Fast Stop (Fault)	Continuous Operation (Alarm Only)
25	-	x	x	-	-	x	-	-
26	x	-	-	x	-	x	-	-
27	-	x	-	x	-	x	-	-
28	x	-	x	-	-	-	x	-
29	-	x	x	-	-	-	x	-
2A	x	-	-	x	-	-	x	-
2B	-	x	-	x	-	-	x	-
2C	x	-	x	-	-	-	-	x
2D	-	x	x	-	-	-	-	x
2E	x	-	-	x	-	-	-	x
2F	-	x	-	x	-	-	-	x

*1 Set the terminal to N.O. (detects external fault when switched ON) or N.C. (detects external fault when switched OFF).

*2 Set the drive to always detect each fault or to detect only during run.

30: PID Integrator Reset

Setting Value	Function	Description
30	PID Integrator Reset	V/f CL-V/f OLV CLV AOLV OLV/PM AOLV/PM CLV/PM EZOLV Sets the command to reset and hold the PID control integral to 0 when the terminal is ON.

Note:

Refer to "PID control block diagram" for more information.

31: PID Integrator Hold

Setting Value	Function	Description
31	PID Integrator Hold	V/f CL-V/f OLV CLV AOLV OLV/PM AOLV/PM CLV/PM EZOLV Sets the command to hold the integral value of the PID control while the terminal is activated.

When you turn off the input terminal, PID control restarts the integral.

Note:

Refer to "PID control block diagram" for more information.

32: Multi-Step Speed Reference 4

Setting Value	Function	Description
32	Multi-Step Speed Reference 4	V/f CL-V/f OLV CLV AOLV OLV/PM AOLV/PM CLV/PM EZOLV Uses speed references d1-01 to d1-16 to set a multi-step speed reference.

Note:

Refer to "Setting Procedures for Multi-step Speed Operation" in "d: Reference Settings" for more information.

34: PID Soft Starter Disable

Setting Value	Function	Description
34	PID Soft Starter Disable	V/f CL-V/f OLV CLV AOLV OLV/PM AOLV/PM CLV/PM EZOLV Sets the PID soft starter function.

ON : Disabled

Disables b5-17 [PID Accel/Decel Time].

OFF : Enabled

Enables b5-17 [PID Accel/Decel Time].

Note:

Refer to "PID control block diagram" for more information.

35: PID Input (Error) Invert

Setting Value	Function	Description
35	PID Input (Error) Invert	<div style="display: flex; justify-content: space-between; gap: 5px;"> V/f CL-V/f OLV CLV AOLV OLV/PM AOLV/PM CLV/PM EZOLV </div> Sets the command to turn the terminal ON and OFF to switch the PID input level (polarity).

Note:

Refer to “PID control block diagram” for more information.

3E: PID Setpoint Selection 1

Setting Value	Function	Description
3E	PID Setpoint Selection 1	<div style="display: flex; justify-content: space-between; gap: 5px;"> V/f CL-V/f OLV CLV AOLV OLV/PM AOLV/PM CLV/PM EZOLV </div> Set this function and $H1-xx = 3F$ [PID Setpoint Selection 2] together. Sets the function to switch the PID setpoint to $b5-58$ to $b5-60$ [PID Setpoint 2 to 4].

Refer to “b5-58 to b5-60: PID Setpoint 2 to 4” for more information.

3F: PID Setpoint Selection 2

Setting Value	Function	Description
3F	PID Setpoint Selection 2	<div style="display: flex; justify-content: space-between; gap: 5px;"> V/f CL-V/f OLV CLV AOLV OLV/PM AOLV/PM CLV/PM EZOLV </div> Set this function and $H1-xx = 3E$ [PID Setpoint Selection 1] at the same time. Sets the function to switch the PID setpoint to $b5-58$ to $b5-60$ [PID Setpoint 2 to 4].

Refer to *b5-58 to b5-60: PID Setpoints 2 to 4 on page 719* for more information.

40: Forward RUN (2-Wire)

Setting Value	Function	Description
40	Forward RUN (2-Wire)	<div style="display: flex; justify-content: space-between; gap: 5px;"> V/f CL-V/f OLV CLV AOLV OLV/PM AOLV/PM CLV/PM EZOLV </div> Sets the Forward Run command for 2-wire sequence 1. Set this function and $H1-xx = 41$ [Reverse RUN (2-Wire)] together.

ON : Forward Run

OFF : Stop

Note:

- If you turn ON the Forward Run command terminal and the Reverse Run command terminal, it will cause an *EF [FWD/REV Run Command Input Error]* alarm and the motor will ramp to stop.
- Initialize the drive with a 2-wire sequence to set the Forward Run command to terminal S1.
- This function will not operate at the same time as $H1-xx = 42, 43$ [Run Command (2-Wire Sequence 2), FWD/REV (2-Wire Sequence 2)].

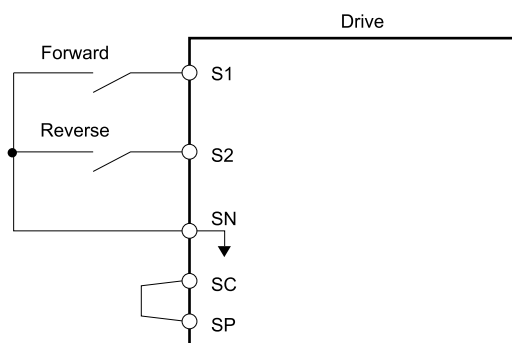

Figure 12.87 2-Wire Sequence Wiring Example

41: Reverse RUN (2-Wire)

Setting Value	Function	Description
41	Reverse RUN (2-Wire)	<div style="display: flex; justify-content: space-between; gap: 5px;"> V/f CL-V/f OLV CLV AOLV OLV/PM AOLV/PM CLV/PM EZOLV </div> Sets the Forward Run command for 2-wire sequence 1. Set this function and $H1-xx = 40$ [Forward RUN (2-Wire)] together.

ON : Reverse Run

OFF : Stop

Note:

- If you turn ON the Forward Run command terminal and the Reverse Run command terminal, it will cause an *EF [FWD/REV Run Command Input Error]* alarm and the motor will ramp to stop.
- Initialize the drive with a 2-wire sequence to set the Reverse Run command to terminal S2.
- This function will not operate at the same time as *H1-xx = 42, 43 [Run Command (2-Wire Sequence 2), FWD/REV (2-Wire Sequence 2)]*.

■ **42: Run Command (2-Wire Sequence 2)**

Setting Value	Function	Description
42	Run Command (2-Wire Sequence 2)	<div style="display: flex; justify-content: space-between; gap: 5px;"> V/f CL-V/f OLV CLV AOLV OLV/PM AOLV/PM CLV/PM EZOLV </div> <p>Sets the Run command for 2-wire sequence 2. Set this function and <i>H1-xx = 43 [FWD/REV (2-Wire Sequence 2)]</i> together.</p>

ON : Run

OFF : Stop

Note:

This function will not operate at the same time as *H1-xx = 40, 41 [Forward RUN (2-Wire), Reverse RUN (2-Wire)]*.

■ **43: FWD/REV (2-Wire Sequence 2)**

Setting Value	Function	Description
43	FWD/REV (2-Wire Sequence 2)	<div style="display: flex; justify-content: space-between; gap: 5px;"> V/f CL-V/f OLV CLV AOLV OLV/PM AOLV/PM CLV/PM EZOLV </div> <p>Sets the direction of motor rotation for 2-wire sequence 2. Set this function and <i>H1-xx = 42 [Run Command (2-Wire Sequence 2)]</i> together.</p>

ON : Reverse Run

OFF : Forward Run

Note:

- You must input the Run command to rotate the motor.
- This function will not operate at the same time as *H1-xx = 40, 41 [Forward RUN (2-Wire), Reverse RUN (2-Wire)]*.

■ **44: Add Offset Frequency 1 (d7-01)**

Setting Value	Function	Description
44	Add Offset Frequency 1 (d7-01)	<div style="display: flex; justify-content: space-between; gap: 5px;"> V/f CL-V/f OLV CLV AOLV OLV/PM AOLV/PM CLV/PM EZOLV </div> <p>Sets the function to add the offset frequency set in <i>d7-01 [Offset Frequency 1]</i> to the frequency reference when the terminal activates.</p>

Note:

Refer to [d7: Offset Frequency on page 776](#) for more information.

■ **45: Add Offset Frequency 2 (d7-02)**

Setting Value	Function	Description
45	Add Offset Frequency 2 (d7-02)	<div style="display: flex; justify-content: space-between; gap: 5px;"> V/f CL-V/f OLV CLV AOLV OLV/PM AOLV/PM CLV/PM EZOLV </div> <p>Sets the function to add the offset frequency set in <i>d7-02 [Offset Frequency 2]</i> to the frequency reference when the terminal activates.</p>

Note:

Refer to [d7: Offset Frequency on page 776](#) for more information.

■ **46: Add Offset Frequency 3 (d7-03)**

Setting Value	Function	Description
46	Add Offset Frequency 3 (d7-03)	<div style="display: flex; justify-content: space-between; gap: 5px;"> V/f CL-V/f OLV CLV AOLV OLV/PM AOLV/PM CLV/PM EZOLV </div> <p>Sets the function to add the offset frequency set in <i>d7-03 [Offset Frequency 3]</i> to the frequency reference when the terminal activates.</p>

Note:

Refer to [d7: Offset Frequency on page 776](#) for more information.

■ **47: Node Setup (CANopen)**

Setting Value	Function	Description
47	Node Setup (CANopen)	<div style="display: flex; justify-content: space-between; gap: 5px;"> V/f CL-V/f OLV CLV AOLV OLV/PM AOLV/PM CLV/PM EZOLV </div> <p>Sets the function in CANopen communications to start the Node Setup function to set the drive node address from the host controller.</p>

■ 60: DC Injection Braking Command

Setting Value	Function	Description
60	DC Injection Braking Command	<div style="display: flex; justify-content: space-between; align-items: center;"> V/f CL-V/f OLV CLV AOLV OLV/PM AOLV/PM CLV/PM EZOLV </div> Sets the command to use DC Injection Braking to stop the motor.

If you input the Run command or JOG command, it will cancel DC Injection Braking.

Figure 12.88 shows the time chart of the DC Injection Braking function.

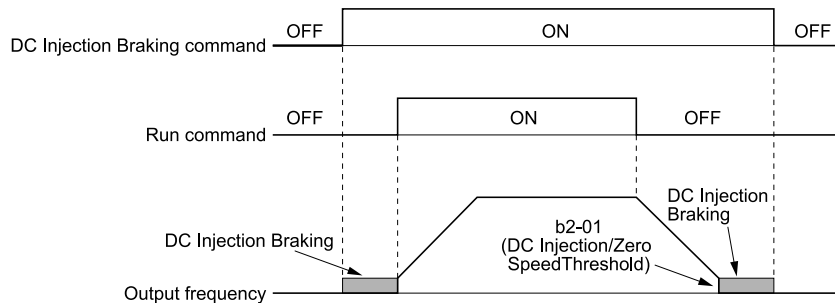

Figure 12.88 DC Injection Braking Time Chart

Note:

- When $A1-02 = 8$ [Control Method Selection = EZOLV], this function is available with a PM motor.
- Refer to [b2: DC Injection Braking and Short Circuit Braking on page 693](#) for more information.

■ 61: Speed Search from Fmax

Setting Value	Function	Description
61	Speed Search from Fmax	<div style="display: flex; justify-content: space-between; align-items: center;"> V/f CL-V/f OLV CLV AOLV OLV/PM AOLV/PM CLV/PM EZOLV </div> Sets the function to use an external reference to start speed search although $b3-01 = 0$ [Speed Search Selection at Start = Disabled] to not allow speed search at start.

When the terminal is activated for $b3-24 = 2$ [Speed Search Method Selection = Current Detection 2], the drive starts speed search from the maximum output frequency.

Note:

- The drive will detect $oPE03$ [Multi-Function Input Setting Err] if you set $H1-xx = 61$ and 62 at the same time.
- Refer to “b3: Speed Search” for more information.

■ 62: Speed Search from Fref

Setting Value	Function	Description
62	Speed Search from Fref	<div style="display: flex; justify-content: space-between; align-items: center;"> V/f CL-V/f OLV CLV AOLV OLV/PM AOLV/PM CLV/PM EZOLV </div> Sets the function to use an external reference to start speed search although $b3-01 = 0$ [Speed Search Selection at Start = Disabled] to not allow speed search at start.

When the terminal is activated for $b3-24 = 2$ [Speed Search Method Selection = Current Detection 2], the drive starts speed search from the frequency reference.

Note:

- The drive will detect $oPE03$ [Multi-Function Input Setting Err] if you set $H1-xx = 61$ and 62 at the same time.
- Refer to “b3: Speed Search” for more information.

■ 63: Field Weakening

Setting Value	Function	Description
63	Field Weakening	<div style="display: flex; justify-content: space-between; align-items: center;"> V/f CL-V/f OLV CLV AOLV OLV/PM AOLV/PM CLV/PM EZOLV </div> Sets the function to send the Field Weakening Level and Field Weakening Frequency Limit commands set in $d6-01$ [Field Weakening Level] and $d6-02$ [Field Weakening Frequency Limit] when the input terminal is activated.

Note:

Refer to [d6: Field Weakening /Forcing on page 775](#) for more information.

■ 65: KEB Ride-Thru 1 Activate (N.C.)

Setting Value	Function	Description
65	KEB Ride-Thru 1 Activate (N.C.)	<div style="display: flex; justify-content: space-between; align-items: center;"> V/f CL-V/f OLV CLV AOLV OLV/PM AOLV/PM CLV/PM EZOLV </div> Sets operation of the KEB1 function through the KEB Ride-Thru 1 (N.C.).

ON : Normal operation

OFF : Deceleration during momentary power loss

When you enable KEB Ride-Thru 1, set L2-29 [KEB Method Selection]. The drive operates with the selected KEB method.

Note:

- If you set KEB Ride-Thru 1 [HI-xx = 65, 66] and KEB Ride-Thru 2 [HI-xx = 7A, 7B] at the same time, the drive will detect oPE03 [Multi-Function Input Setting Err].
- Refer to [KEB Ride-Thru Function on page 917](#) for more information.

■ **66: KEB Ride-Thru 1 Activate (N.O.)**

Setting Value	Function	Description
66	KEB Ride-Thru 1 Activate (N.O.)	<div style="display: flex; justify-content: space-between; gap: 5px;"> V/f CL-V/f OLV CLV AOLV OLV/PM AOLV/PM CLV/PM EZOLV </div> Sets operation of the KEB1 function through the KEB Ride-Thru 1 (N.O.).

ON : Deceleration during momentary power loss

OFF : Normal operation

When you enable KEB Ride-Thru 1, set L2-29 [KEB Method Selection]. The drive operates with the selected KEB method.

Note:

- If you set KEB Ride-Thru 1 [HI-xx = 65, 66] and KEB Ride-Thru 2 [HI-xx = 7A, 7B] at the same time, the drive will detect oPE03 [Multi-Function Input Setting Err].
- Refer to [KEB Ride-Thru Function on page 917](#) for more information.

■ **67: Communications Test Mode**

Setting Value	Function	Description
67	Communications Test Mode	<div style="display: flex; justify-content: space-between; gap: 5px;"> V/f CL-V/f OLV CLV AOLV OLV/PM AOLV/PM CLV/PM EZOLV </div> Set the function for the drive to self-test RS-485 serial communications operation.

The Self-Diagnostics function connects the transmission terminal of the control terminal block to the reception terminal. The function transmits the data that the drive sent to make sure that the drive can communicate correctly.

Note:

Refer to MEMOBUS/Modbus communications “Self-Diagnostics” for the self-diagnostics procedure.

■ **68: High Slip Braking (HSB) Activate**

Setting Value	Function	Description
68	High Slip Braking (HSB) Activate	<div style="display: flex; justify-content: space-between; gap: 5px;"> V/f CL-V/f OLV CLV AOLV OLV/PM AOLV/PM CLV/PM EZOLV </div> Sets the command to use high-slip braking to stop the motor.

Note:

- When you restart the drive after you use high-slip braking, make sure that the drive fully stops the motor then clear the high-slip braking input.
- Refer to “n3: High Slip/Overex Braking” for more information.

■ **6A: Drive Enable**

Setting Value	Function	Description
6 A	Drive Enable	<div style="display: flex; justify-content: space-between; gap: 5px;"> V/f CL-V/f OLV CLV AOLV OLV/PM AOLV/PM CLV/PM EZOLV </div> Sets the function to show dnE [Drive Disabled] on the keypad and ignore Run commands when the terminal is OFF.

If you input the Run command before you turn ON the Drive Enable terminal, you must input the Run command again to operate the drive. When you deactivate the terminal set for Drive Enable while the drive is operating, the drive will use the stopping method set in b1-03 [Stopping Method Selection] to stop the motor.

ON : Run command is accepted.

OFF : Run command is disabled. When the drive is running, it stops according to b1-03 setting.

■ **71: Torque Control**

Setting Value	Function	Description
71	Torque Control	<div style="display: flex; justify-content: space-between; gap: 5px;"> V/f CL-V/f OLV CLV AOLV OLV/PM AOLV/PM CLV/PM EZOLV </div> Sets the function to switch between torque control and speed control.

ON : Torque control**OFF : Speed control****Note:**

When this function is enabled, set $d5-01 = 0$ [Torque Control Selection = Speed Control].

Input the Speed/Torque Control Switchover Time

Use parameter $d5-06$ [Speed/Torque Changeover Time] to set the length of time, in milliseconds, that the drive will wait to switch between speed and torque control. When the speed/torque control switchover signal changes in the time set in $d5-06$, the three analog inputs will keep their present value. Complete the signal switchover with an external source in this time.

Note:

Refer to “Switch Speed Control and Torque Control” for more information.

72: Zero Servo

Setting Value	Function	Description
72	Zero Servo	<div style="display: flex; justify-content: space-between; font-size: small;"> V/f CL-V/f OLV CLV AOLV OLV/PM AOLV/PM CLV/PM EZOLV </div> <p>Sets the function to hold a stopped motor.</p>

This function will hold a stopped motor if an external force is applied or an analog reference is offset.

Note:

- Refer to “b9: Zero Servo” for more information.
- When you use the Zero Servo function, keep the Run command ON. Zero servo stops the motor and if you turn OFF the Run command, it will not have power.

75: Up 2 Command

Setting Value	Function	Description
75	Up 2 Command	<div style="display: flex; justify-content: space-between; font-size: small;"> V/f CL-V/f OLV CLV AOLV OLV/PM AOLV/PM CLV/PM EZOLV </div> <p>Sets the function to increase the frequency reference bias value to accelerate the motor when the terminal is activated. Set this function and $H1-xx = 76$ [Down 2 Command] together.</p>

When you activate the terminal set for Up2 Command, the bias will increase. When you activate the terminal set for Down 2 Command, the bias will decrease. When you activate or deactivate the two commands, the drive will hold the frequency reference. [Table 12.66](#) gives information about the relation between operation of the Up/Down 2 Command and $d4-01$, $d4-03$, and $4-05$.

Note:

- When you use this function, set the optimal bias limit values with $d4-08$ and $d4-09$ [Up/Down 2 Bias Upper Limit/Lower Limit].
- Refer to [d4: Frequency Ref Up/Down & Hold on page 764](#) for more information.

Table 12.66 Up 2 Command, Down 2 Command

Function	Frequency Reference Source	d4-03	d4-05	d4-01	Operation	Storing the Frequency Reference or Frequency Bias
1	Multi-step speed reference	0.00	0	0	<ul style="list-style-type: none"> When the Up 2 Command is active, the drive accelerates the motor (increases the bias value). When the Down 2 Command is active, the drive decelerates the motor (decreases the bias value) When the Up 2 Command and Down 2 Command are active or not active, the drive holds the output frequency. (holds the bias value). When the frequency changes, it will reset the bias. For all other statuses, the drive will follow the frequency reference. 	Not stored.
2				1		When the bias value and frequency reference are constant for 5 seconds after the frequency reference hold starts, the drive will add the bias value to the enabled frequency reference, then reset.
3				-		Not stored.
4	Multi-step speed reference	> 0	-	0	<ul style="list-style-type: none"> When the Up 2 Command is active, the drive accelerates the motor to "Frequency Reference + d4-03" (the bias value will increase to the value set in d4-03) When the Down 2 Command is active, the drive decelerates the motor to "Frequency Reference - d4-03" (the bias value will decrease to the value set in d4-03). When the Up 2 Command and Down 2 Command are active or not active, the drive holds the output frequency. (holds the bias value). When the frequency changes, it will reset the bias. For all other statuses, the drive will follow the frequency reference. 	Not stored.
5				1		When the bias value and frequency reference are constant for 5 seconds after the frequency reference hold starts, the drive will add the bias value to the enabled frequency reference, then reset.
6	Others (Analog input, transmission)	0	0	0	<ul style="list-style-type: none"> When the Up 2 Command is active, the drive accelerates the motor (increases the bias value). When the Down 2 Command is active, the drive decelerates the motor (decreases the bias value) When the Up 2 Command and Down 2 Command are active or not active, the drive holds the output frequency (holds the bias value). During acceleration or deceleration, when the frequency reference increases or decreases more than d4-07, the drive holds the bias value until the output frequency and the actual frequency reference agree (speed agreement). 	Not stored.
7				1		When the bias value is constant for 5 seconds after the frequency reference hold starts, the drive will store the bias value in d4-06. You cannot rewrite the frequency reference is not possible. The drive will store only the bias value.
8	Others (Analog input, transmission)	0	1	-	<ul style="list-style-type: none"> When the Up 2 Command is active, the drive accelerates the motor (increases the bias value). When the Down 2 Command is active, the drive decelerates the motor (decreases the bias value) For all other statuses, the drive will follow the frequency reference. 	Not stored.
9				0		Not stored.
10				> 0		-

■ **76: Down 2 Command**

Setting Value	Function	Description
76	Down 2 Command	<div style="display: flex; justify-content: space-between; align-items: center;"> <input type="checkbox"/> V/f <input type="checkbox"/> CL-V/f <input type="checkbox"/> OLV <input type="checkbox"/> CLV <input type="checkbox"/> AOLV <input type="checkbox"/> OLV/PM <input type="checkbox"/> AOLV/PM <input type="checkbox"/> CLV/PM <input type="checkbox"/> EZOLV </div> <p>Sets the function to decrease the frequency reference bias value to decelerate the motor when the terminal is activated. Set this function and H1-xx = 75 [Up 2 Command] together.</p>

When you activate the terminal set for Up2 Command, the bias will increase. When you activate the terminal set for Down 2 Command, the bias will decrease. When you activate or deactivate the two commands, the drive will hold the frequency reference.

Note:

- When you use this function, set the optimal bias limit values with *d4-08* and *d4-09* [*Up/Down 2 Bias Upper Limit/Lower Limit*].
- Refer to [d4: Frequency Ref Up/Down & Hold on page 764](#) for more information.

■ 77: ASR Gain (C5-03) Select

Setting Value	Function	Description
77	ASR Gain (C5-03) Select	<div style="display: flex; justify-content: space-between; align-items: center;"> V/f CL-V/f OLV CLV AOLV OLV/PM AOLV/PM CLV/PM EZOLV </div> <p>Sets the function to switch the ASR proportional gain to <i>C5-01</i> [<i>ASR Proportional Gain 1</i>] or <i>C5-03</i> [<i>ASR Proportional Gain 2</i>].</p>

ON : C5-03

Switches the proportional gain to *C5-03* [*ASR Proportional Gain 2*].

OFF : C5-01

Switches the proportional gain to *C5-01* [*ASR Proportional Gain 1*].

Note:

Refer to “C5: Automatic Speed Regulator (ASR)” for more information.

■ 78: Analog TorqueRef Polarity Invert

Setting Value	Function	Description
78	Analog TorqueRef Polarity Invert	<div style="display: flex; justify-content: space-between; align-items: center;"> V/f CL-V/f OLV CLV AOLV OLV/PM AOLV/PM CLV/PM EZOLV </div> <p>Sets the rotation direction of the external torque reference.</p>

ON : External torque reference reverse direction**OFF : External torque reference forward direction**

■ 7A: KEB Ride-Thru 2 Activate (N.C.)

Setting Value	Function	Description
7A	KEB Ride-Thru 2 Activate (N.C.)	<div style="display: flex; justify-content: space-between; align-items: center;"> V/f CL-V/f OLV CLV AOLV OLV/PM AOLV/PM CLV/PM EZOLV </div> <p>Sets operation of the KEB2 function through the KEB Ride-Thru 2 (N.C.).</p>

ON : Normal operation**OFF : Deceleration during momentary power loss**

When KEB Ride-Thru 2 is input, the drive will use Single Drive KEB Ride-Thru 2 for KEB operation. The *L2-29* [*KEB Method Selection*] setting will not have an effect.

Note:

- If you set *KEB Ride-Thru 1* [*H1-xx = 65, 66*] and *KEB Ride-Thru 2* [*H1-xx = 7A, 7B*] at the same time, the drive will detect *oPE03* [*Multi-Function Input Setting Err*].
- Refer to [KEB Ride-Thru Function on page 917](#) for more information.

■ 7B: KEB Ride-Thru 2 Activate (N.O.)

Setting Value	Function	Description
7B	KEB Ride-Thru 2 Activate (N.O.)	<div style="display: flex; justify-content: space-between; align-items: center;"> V/f CL-V/f OLV CLV AOLV OLV/PM AOLV/PM CLV/PM EZOLV </div> <p>Sets operation of the KEB2 function through the KEB Ride-Thru 2 (N.O.).</p>

ON : Deceleration during momentary power loss**OFF : Normal operation**

When KEB Ride-Thru 2 is input, the drive will use Single Drive KEB Ride-Thru 2 for KEB operation. The *L2-29* [*KEB Method Selection*] setting will not have an effect.

Note:

- If you set *KEB Ride-Thru 1* [*H1-xx = 65, 66*] and *KEB Ride-Thru 2* [*H1-xx = 7A, 7B*] at the same time, the drive will detect *oPE03* [*Multi-Function Input Setting Err*].
- Refer to [KEB Ride-Thru Function on page 917](#) for more information.

■ 7C: Short Circuit Braking (N.O.)

Setting Value	Function	Description
7C	Short Circuit Braking (N.O.)	<div style="display: flex; justify-content: space-between; align-items: center;"> V/f CL-V/f OLV CLV AOLV OLV/PM AOLV/PM CLV/PM EZOLV </div> <p>Sets operation of Short Circuit Braking (N.O.).</p>

WARNING! Incorrect Operation. Yaskawa recommends that you use $H1-xx = 7D$ [Short Circuit Braking (N.C.)]. If a circuit error occurs in the MFDI, the motor can take longer than expected to stop when the terminal set to $H1-xx = 7C$ [Short Circuit Braking (N.O.)] turns ON.

The drive will short circuit the three phases of a PM motor to cause braking torque in the spinning motor.

Note:

- When $A1-02 = 8$ [Control Method Selection = EZOLV], this function is available only when you use a PM motor.
- Refer to [b2: DC Injection Braking and Short Circuit Braking on page 693](#) for more information.

ON : Short Circuit Braking is enabled.

OFF : Normal operation

■ **7D: Short Circuit Braking (N.C.)**

Setting Value	Function	Description
7D	Short Circuit Braking (N.C.)	<div style="display: flex; justify-content: space-between; font-size: small;"> V/f CL-V/f OLV CLV AOLV OLV/PM AOLV/PM CLV/PM EZOLV </div> Sets operation of Short Circuit Braking (N.C.).

The drive will short circuit the three phases of a PM motor to cause braking torque in the spinning motor.

Note:

- When $A1-02 = 8$ [Control Method Selection = EZOLV], this function is available only when you use a PM motor.
- Refer to [b2: DC Injection Braking and Short Circuit Braking on page 693](#) for more information.

ON : Normal operation

OFF : Short Circuit Braking is enabled.

■ **7E: Reverse Rotation Identifier**

Setting Value	Function	Description
7E	Reverse Rotation Identifier	<div style="display: flex; justify-content: space-between; font-size: small;"> V/f CL-V/f OLV CLV AOLV OLV/PM AOLV/PM CLV/PM EZOLV </div> Sets the rotation direction of the motor when in Simple Closed Loop V/f Control method and $F1-21, F1-37 = 0$ [Encoder Option Function Selection = A pulse detection], or when in Closed Loop V/f Control method.

ON : Reverse run

The drive knows that the motor is rotating in reverse.

OFF : Forward run

The drive knows that the motor is rotating forward.

■ **7F: PID Bi-Directional Enable**

Setting Value	Function	Description
7F	PID Bi-Directional Enable	<div style="display: flex; justify-content: space-between; font-size: small;"> V/f CL-V/f OLV CLV AOLV OLV/PM AOLV/PM CLV/PM EZOLV </div> Sets operation of the PID Bi-Directional function.

ON : Enabled

OFF : Disabled

■ **90 to 97: DriveWorksEZ Digital Inputs 1 to 8**

Setting Value	Function	Description
90 - 97	DWEZ Digital Inputs 1 to 8	<div style="display: flex; justify-content: space-between; font-size: small;"> V/f CL-V/f OLV CLV AOLV OLV/PM AOLV/PM CLV/PM EZOLV </div> Sets digital inputs used with DriveWorksEZ. Refer to the DriveWorksEZ online manual for more information.

Note:

You cannot set values 90 to 97 for inverse output.

■ **9F: DWEZ Disable**

Setting Value	Function	Description
9F	DWEZ Disable	<div style="display: flex; justify-content: space-between; font-size: small;"> V/f CL-V/f OLV CLV AOLV OLV/PM AOLV/PM CLV/PM EZOLV </div> Sets operation of the DriveWorksEZ program saved in the drive.

Note:

Set $A1-07 = 2$ [DriveWorksEZ Function Selection = Enabled/Disabled wDigital Input] to use this function.

ON : Disabled

OFF : Enabled

■ 101 to 19F: Inverse Input of 1 to 9F

Setting Value	Function	Description
101 to 19F	Inverse Inputs of 1 to 9F	Sets the function of the selected MFDI to operate inversely. To select the function, enter "1xx", where the "xx" is the function setting value.

For example, to use the inverse input of *E* [*ASR Integral Reset*], set $H1-xx = 10E$.

Note:

You cannot use inverse input for all functions. Refer to [Table 12.61](#) for more information.

◆ H2: Multi-function Digital Output

H2 parameters set the MFDO terminal functions.

■ H2-01 to H2-03 Terminal M1-M2, M3-M4, M5-M6 Function Selection

The drive has three MFDO terminals. [Table 12.67](#) shows the default function settings for the terminals.

Table 12.67 MFDO Terminals Default Function Settings

No.	Name	Default	Function
H2-01	Term M1-M2 Function Selection	0	During Run
H2-02	Term M3-M4 Function Selection	1	Zero Speed
H2-03	Terminal M5-M6 Function Select	2	Speed Agree 1

Refer to [Table 12.68](#) to set $H2-xx$ [*MFDO Function Select*].

Table 12.68 MFDO Setting Values

Setting Value	Function	Ref.	Setting Value	Function	Ref.
0	During Run	870	1A	During Reverse	877
1	Zero Speed	870	1B	During Baseblock (N.C.)	877
2	Speed Agree 1	870	1C	Motor 2 Selected	877
3	User-Set Speed Agree 1	871	1D	During Regeneration	877
4	Frequency Detection 1	871	1E	Executing Auto-Restart	878
5	Frequency Detection 2	872	1F	Motor Overload Alarm (oL1)	878
6	Drive Ready	872	20	Drive Overheat Pre-Alarm (oH)	878
7	DC Bus Undervoltage	873	21	Safety Monitor Output Status	878
8	During Baseblock (N.O.)	873	22	Mechanical Weakening Detection	878
9	Frequency Reference from Keypad	873	2F	Maintenance Notification	878
A	Run Command Source	873	30	During Torque Limit	879
B	Torque Detection 1 (N.O.)	873	31	During Speed Limit	879
C	Frequency Reference Loss	873	32	In Speed Limit During Trq Ctrl	879
D	Braking Resistor Fault	874	33	Zero Servo Complete	879
E	Fault	874	37	During Frequency Output	879
F *1	Not Used	874	38	Drive Enabled	880
10	Alarm	874	39	Watt Hour Pulse Output	880
11	Fault Reset Command Active	874	3C	LOCAL Control Selected	880
12	Timer Output	874	3D	During Speed Search	880
13	Speed Agree 2	874	3E	PID Feedback Low	880
14	User-Set Speed Agree 2	875	3F	PID Feedback High	881
15	Frequency Detection 3	875	4A	During KEB Ride-Thru	881
16	Frequency Detection 4	876	4B	During Short Circuit Braking	881
17	Torque Detection 1 (N.C.)	876	4C	During Fast Stop	881
18	Torque Detection 2 (N.O.)	876	4D	oH Pre-Alarm Time Limit	881
19	Torque Detection 2 (N.C.)	877	4E *2	Braking Transistor Fault (rr)	881

Setting Value	Function	Ref.
4F *2	Braking Resistor Overheat (rH)	881
60	Internal Cooling Fan Alarm	881
61	Pole Position Detection Complete	882
62	Modbus Reg 1 Status Satisfied	882
63	Modbus Reg 2 Status Satisfied	882
65	Standby Output	882
66	Comparator1	882
67	Comparator2	883

Setting Value	Function	Ref.
69	External Power 24V Supply	883
6A	Data Logger Error	883
90 - 93	DWEZ Digital Output 1 to 4	884
A0 - A7	DWEZ Extended Digital Outputs 1 to 8	884
100 - 1A7	Inverse output of 0 to A7 Sets an inverse output of the function for the MFDO. Put a 1 at the front of the function setting to set inverse output. For example, set 138 for inverse output of 38 [Drive Enabled].	884

- *1 Inverse output is not available.
- *2 You cannot set this parameter on models 2169 to 2415 and 4089 to 4H12.

Extended MFDO1 to MFDO3 Function Selection

You can set MFDO functions to bit 0 to bit 2 [MEMOBUS MFDO1 to 3] of MEMOBUS register 15E0 (Hex.). Use H2-40 to H2-42 [Mbus Reg 15E0h bit0 to bit2 Output Func] to select the function.

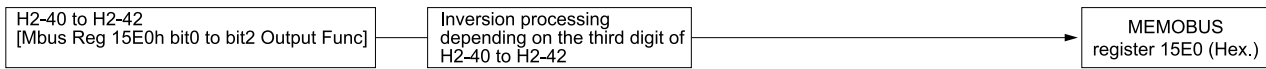

Figure 12.89 Functional Block Diagram of MEMOBUS Multi-function Output

Table 12.69 MEMOBUS MFDO Registers

Register number (Hex.)	Name	
15E0	bit0	MEMOBUS MFDO 1
	bit1	MEMOBUS MFDO 2
	bit2	MEMOBUS MFDO 3

Note:

- Refer to MFDO Setting Values on page 869 for more information about MFDO setting values.
- When you do not set functions to H2-40 to H2-42, set them to F.

Output of Logical Operation Results of MFDO

This enables the logical operation results of two MFDOs to be output to one MFDO terminal.

Use H2-60, H2-63, and H2-66 [Term M1-M2 Secondary Function to Term M5-M6 Secondary Function] to set the function of the output signal for which logical operations are performed.

Use H2-61, H2-64, H2-67 [Term M1-M2 Logical Operation to Term M5-M6 Logical Operation] to set the logical operation.

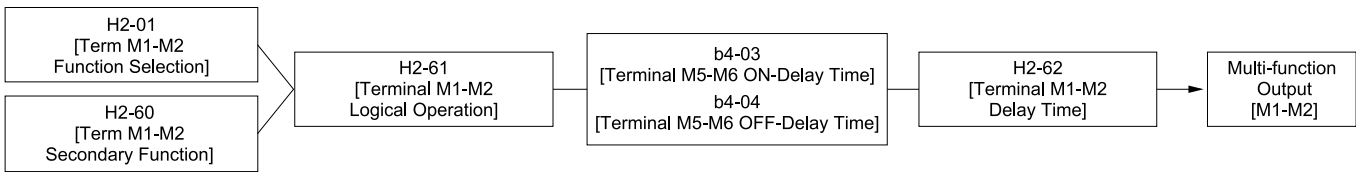
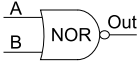
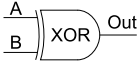
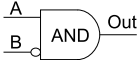
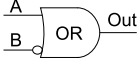

Figure 12.90 Functional Block Diagram of Logical Operation Output for MFDO 1

Table 12.70 MFDO Logical Operation Table

Logical Operation Selection	Logical Operation Expression	Logical Operation Notation
H2-61, H2-64, H2-67		
0	A=B=1	
1	A=1 or B=1	
2	A=0 or B=0	

Logical Operation Selection	Logical Operation Expression	Logical Operation Notation
H2-61, H2-64, H2-67		
3	$A=B=0$	
4	$A=B$	$A=B$
5	$A \neq B$	
6	$AND(A, \bar{B})$	
7	$OR(A, \bar{B})$	
8	-	On

Note:

- When you use the function to output logical calculation results, you cannot set H2-01 to H2-03 = 1xx [Inverse Output of xx]. If you do, the drive will detect oPE33 [Digital Output Selection Error].
- When you do not use H2-60, H2-63, and H2-66, set them to F. The through mode function is not supported.

■ H2-01: Term M1-M2 Function Selection

No. (Hex.)	Name	Description	Default (Range)
H2-01 (040B)	Term M1-M2 Function Selection	<input type="checkbox"/> V/f <input type="checkbox"/> CL-V/f <input type="checkbox"/> OLV <input type="checkbox"/> CLV <input type="checkbox"/> AOLV <input type="checkbox"/> OLV/PM <input type="checkbox"/> AOLV/PM <input type="checkbox"/> CLV/PM <input type="checkbox"/> EZOLV Sets the function for MFDO terminal M1-M2.	0 (0 - 1FF)

Note:

When you do not use the terminal or when you use the terminal in through mode, set this parameter to F.

■ H2-02: Term M3-M4 Function Selection

No. (Hex.)	Name	Description	Default (Range)
H2-02 (040C)	Term M3-M4 Function Selection	<input type="checkbox"/> V/f <input type="checkbox"/> CL-V/f <input type="checkbox"/> OLV <input type="checkbox"/> CLV <input type="checkbox"/> AOLV <input type="checkbox"/> OLV/PM <input type="checkbox"/> AOLV/PM <input type="checkbox"/> CLV/PM <input type="checkbox"/> EZOLV Sets the function for MFDO terminal M3-M4.	1 (0 - 1FF)

Note:

When you do not use the terminal or when you use the terminal in through mode, set this parameter to F.

■ H2-03: Terminal M5-M6 Function Selection

No. (Hex.)	Name	Description	Default (Range)
H2-03 (040D)	Term M5-M6 Function Selection	<input type="checkbox"/> V/f <input type="checkbox"/> CL-V/f <input type="checkbox"/> OLV <input type="checkbox"/> CLV <input type="checkbox"/> AOLV <input type="checkbox"/> OLV/PM <input type="checkbox"/> AOLV/PM <input type="checkbox"/> CLV/PM <input type="checkbox"/> EZOLV Sets the function for MFDO terminal M5-M6.	2 (0 - 1FF)

Note:

When you do not use the terminal or when you use the terminal in through mode, set this parameter to F.

■ H2-06: Watt Hour Output Unit Selection

No. (Hex.)	Name	Description	Default (Range)
H2-06 (0437)	Watt Hour Output Unit Selection	<input type="checkbox"/> V/f <input type="checkbox"/> CL-V/f <input type="checkbox"/> OLV <input type="checkbox"/> CLV <input type="checkbox"/> AOLV <input type="checkbox"/> OLV/PM <input type="checkbox"/> AOLV/PM <input type="checkbox"/> CLV/PM <input type="checkbox"/> EZOLV Sets the unit for the output signal when H2-01 to H2-03 = 39 [MFDO Function Selection = Watt Hour Pulse Output].	0 (0 - 4)

This output is input to the Watt hour meter or PLC through a 200 ms pulse signal. This parameter sets the kWh unit for each pulse output.

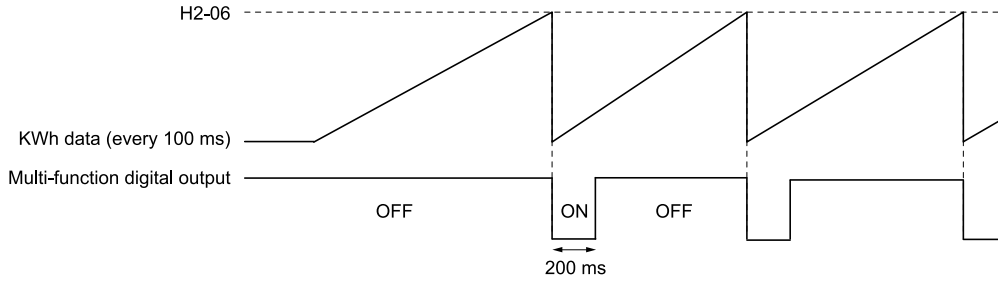

Figure 12.91 Example MFDO when Configured for Watt Hours

Note:

- When the power value is a negative value (regenerative state), the drive does not count Watt hours.
- When the control power supply to the drive is operating, the drive will keep the Watt hours. If a momentary power loss causes the drive to lose control power, the Watt hour count will reset.

0 : 0.1 kWh units

1 : 1 kWh units

2 : 10 kWh units

3 : 100 kWh units

4 : 1000 kWh units

■ **H2-07: Modbus Register 1 Address Select**

No. (Hex.)	Name	Description	Default (Range)
H2-07 (0B3A)	Modbus Register 1 Address Select	<input type="checkbox"/> V/f <input type="checkbox"/> CL-V/f <input type="checkbox"/> OLV <input type="checkbox"/> CLV <input type="checkbox"/> AOLV <input type="checkbox"/> OL/PM <input type="checkbox"/> AOLV/PM <input type="checkbox"/> CLV/PM <input type="checkbox"/> EZOLV Sets the address of the MEMOBUS/Modbus register output to the MFDO terminal.	0001 (0001 - 1FFF)

Sets the address of the register that is output to *Modbus Reg 1 Status Satisfied* [H2-01 to H2-03 = 62] and uses the bit in H2-08 [Modbus Register 1 Bit Select].

■ **H2-08: Modbus Register 1 Bit Select**

No. (Hex.)	Name	Description	Default (Range)
H2-08 (0B3B)	Modbus Register 1 Bit Select	<input type="checkbox"/> V/f <input type="checkbox"/> CL-V/f <input type="checkbox"/> OLV <input type="checkbox"/> CLV <input type="checkbox"/> AOLV <input type="checkbox"/> OL/PM <input type="checkbox"/> AOLV/PM <input type="checkbox"/> CLV/PM <input type="checkbox"/> EZOLV Sets the bit of the MEMOBUS/Modbus register output to the MFDO terminal.	0000 (0000 - FFFF)

Sets the bit of the register that is output to *Modbus Reg 1 Status Satisfied* [H2-01 to H2-03 = 62] and uses the address in H2-07 [Modbus Register 1 Address Select].

■ **H2-09: Modbus Register 2 Address Select**

No. (Hex.)	Name	Description	Default (Range)
H2-09 (0B3C)	Modbus Register 2 Address Select	<input type="checkbox"/> V/f <input type="checkbox"/> CL-V/f <input type="checkbox"/> OLV <input type="checkbox"/> CLV <input type="checkbox"/> AOLV <input type="checkbox"/> OL/PM <input type="checkbox"/> AOLV/PM <input type="checkbox"/> CLV/PM <input type="checkbox"/> EZOLV Sets the address of the MEMOBUS/Modbus register output to the MFDO terminal.	0001 (0001 - 1FFF)

Sets H2-09 with the address of the register that is output to *Modbus Reg 2 Status Satisfied* [H2-01 to H2-03 = 63] and uses the bit in H2-10 [Modbus Register 2 Bit Select].

■ **H2-10: Modbus Register 2 Bit Select**

No. (Hex.)	Name	Description	Default (Range)
H2-10 (0B3D)	Modbus Register 2 Bit Select	<input type="checkbox"/> V/f <input type="checkbox"/> CL-V/f <input type="checkbox"/> OLV <input type="checkbox"/> CLV <input type="checkbox"/> AOLV <input type="checkbox"/> OL/PM <input type="checkbox"/> AOLV/PM <input type="checkbox"/> CLV/PM <input type="checkbox"/> EZOLV Sets the bit of the MEMOBUS/Modbus register output to the MFDO terminal.	0000 (0000 - FFFF)

Sets the bit of the register that is output to *Modbus Reg 2 Status Satisfied* [H2-01 to H2-03 = 63] and uses the address in H2-09.

■ H2-20: Comparator 1 Monitor Selection

No. (Hex.)	Name	Description	Default (Range)
H2-20 (1540)	Comparator 1 Monitor Selection	V/f CL-V/f OLV CLV AOLV OLV/PM AOLV/PM CLV/PM EZOLV Sets the monitor number (<i>Ux-xx</i>) for comparator 1.	102 (000 - 9999)

Note:

- Set the *x-xx* part of the *Ux-xx* [Monitor]. For example, set *H2-20* = 102 to monitor *U1-02* [Output Frequency]. When the *x* part of *Ux* is a letter, replace the letter (hexadecimal number) with a decimal number. For example, set *H2-20* = 1301 to monitor *Ud-01*.
- Refer to [66: Comparator1 on page 882](#) and [67: Comparator2 on page 883](#) for more information about the comparator function.
- The monitors you can set change when the control method changes.

■ H2-21: Comparator 1 Lower Limit

No. (Hex.)	Name	Description	Default (Range)
H2-21 (1541)	Comparator 1 Lower Limit	V/f CL-V/f OLV CLV AOLV OLV/PM AOLV/PM CLV/PM EZOLV Sets the lower limit detection level for comparator 1 when the full scale analog output for the monitor selected in <i>H2-20</i> [Comparator 1 Monitor Selection] is the 100% value.	0.0% (0.0 - 300.0%)

Note:

For information on the comparator function, refer to [66: Comparator1 on page 882](#) and [67: Comparator2 on page 883](#).

■ H2-22: Comparator 1 Upper Limit

No. (Hex.)	Name	Description	Default (Range)
H2-22 (1542)	Comparator 1 Upper Limit	V/f CL-V/f OLV CLV AOLV OLV/PM AOLV/PM CLV/PM EZOLV Sets the upper limit detection level for comparator 1 when the full scale analog output for the monitor selected in <i>H2-20</i> [Comparator 1 Monitor Selection] is the 100% value.	0.0% (0.0 - 300.0%)

Note:

For information on the comparator function, refer to [66: Comparator1 on page 882](#) and [67: Comparator2 on page 883](#).

■ H2-23: Comparator 1 Hysteresis

No. (Hex.)	Name	Description	Default (Range)
H2-23 (1543)	Comparator 1 Hysteresis	V/f CL-V/f OLV CLV AOLV OLV/PM AOLV/PM CLV/PM EZOLV Sets the hysteresis level for comparator 1 as a percentage of the full scale analog output for the monitor selected in <i>H2-20</i> [Comparator 1 Monitor Selection].	0.0% (0.0 - 10.0%)

Note:

For information on the comparator function, refer to [66: Comparator1 on page 882](#) and [67: Comparator2 on page 883](#).

■ H2-24: Comparator 1 On-Delay Time

No. (Hex.)	Name	Description	Default (Range)
H2-24 (1544)	Comparator 1 On-Delay Time	V/f CL-V/f OLV CLV AOLV OLV/PM AOLV/PM CLV/PM EZOLV Sets the on-delay time for comparator 1.	0.0 s (0.0 - 600.0 s)

Note:

For information on the comparator function, refer to [66: Comparator1 on page 882](#) and [67: Comparator2 on page 883](#).

■ H2-25: Comparator 1 Off-Delay Time

No. (Hex.)	Name	Description	Default (Range)
H2-25 (1545)	Comparator 1 Off-Delay Time	V/f CL-V/f OLV CLV AOLV OLV/PM AOLV/PM CLV/PM EZOLV Sets the off-delay time for comparator 1.	0.0 s (0.0 - 600.0 s)

Note:

For information on the comparator function, refer to [66: Comparator1 on page 882](#) and [67: Comparator2 on page 883](#).

■ H2-26: Comparator 2 Monitor Selection

No. (Hex.)	Name	Description	Default (Range)
H2-26 (1546)	Comparator 2 Monitor Selection	V/f CL-V/f OLV CLV AOLV OLV/PM AOLV/PM CLV/PM EZOLV Sets the monitor number (<i>Ux-xx</i>) for comparator 2.	103 (000 - 9999)

Note:

- Set the *x-xx* part of the *Ux-xx* [Monitor]. For example, set *H2-26 = 103* to monitor *U1-03* [Output Current]. When the *x* part of *Ux* is a letter, replace the letter (hexadecimal number) with a decimal number. For example, set *H2-26 = 1301* to monitor *Ud-01*.
- The monitors you can set change when the control method changes.
- When you use the terminal in through mode, set this parameter to *000* or *031*. You can set the terminal output level from the PLC through MEMOBUS/Modbus communications or the communication option.
- Refer to [66: Comparator1 on page 882](#) and [67: Comparator2 on page 883](#) for more information about the comparator function.

■ H2-27: Comparator 2 Lower Limit

No. (Hex.)	Name	Description	Default (Range)
H2-27 (1547)	Comparator 2 Lower Limit	V/f CL-V/f OLV CLV AOLV OLV/PM AOLV/PM CLV/PM EZOLV Sets the lower limit detection level for comparator 2 as a percentage of the full scale analog output for the monitor selected in <i>H2-26</i> [Comparator 2 Monitor Selection].	0.0% (0.0 - 300.0%)

Note:

For information on the comparator function, refer to [66: Comparator1 on page 882](#) and [67: Comparator2 on page 883](#).

■ H2-28: Comparator 2 Upper Limit

No. (Hex.)	Name	Description	Default (Range)
H2-28 (1548)	Comparator 2 Upper Limit	V/f CL-V/f OLV CLV AOLV OLV/PM AOLV/PM CLV/PM EZOLV Sets the upper limit detection level for comparator 2 as a percentage of the full scale analog output for the monitor selected in <i>H2-26</i> [Comparator 2 Monitor Selection].	0.0% (0.0 - 300.0%)

Note:

For information on the comparator function, refer to [66: Comparator1 on page 882](#) and [67: Comparator2 on page 883](#).

■ H2-29: Comparator 2 Hysteresis

No. (Hex.)	Name	Description	Default (Range)
H2-29 (1549)	Comparator 2 Hysteresis	V/f CL-V/f OLV CLV AOLV OLV/PM AOLV/PM CLV/PM EZOLV Sets the hysteresis level for comparator 2 as a percentage of the full scale analog output for the monitor selected in <i>H2-26</i> [Comparator 2 Monitor Selection].	0.0% (0.0 - 10.0%)

Note:

For information on the comparator function, refer to [66: Comparator1 on page 882](#) and [67: Comparator2 on page 883](#).

■ H2-30: Comparator 2 On-Delay Time

No. (Hex.)	Name	Description	Default (Range)
H2-30 (154A)	Comparator 2 On-Delay Time	V/f CL-V/f OLV CLV AOLV OLV/PM AOLV/PM CLV/PM EZOLV Sets the on-delay time for comparator 2.	0.0 s (0.0 - 600.0 s)

Note:

For information on the comparator function, refer to [66: Comparator1 on page 882](#) and [67: Comparator2 on page 883](#).

■ H2-31: Comparator 2 Off-Delay Time

No. (Hex.)	Name	Description	Default (Range)
H2-31 (154B)	Comparator 2 Off-Delay Time	V/f CL-V/f OLV CLV AOLV OLV/PM AOLV/PM CLV/PM EZOLV Sets the off-delay time for comparator 2.	0.0 s (0.0 - 600.0 s)

Note:

For information on the comparator function, refer to [66: Comparator1 on page 882](#) and [67: Comparator2 on page 883](#).

■ H2-32: Comparator 1 Filter Time

No. (Hex.)	Name	Description	Default (Range)
H2-32 (159A)	Comparator 1 Filter Time	<div style="display: flex; justify-content: space-between; gap: 5px;"> V/f CL-V/f OLV CLV AOLV OLV/PM AOLV/PM CLV/PM EZOLV </div> Sets the time constant that is applied to the primary delay filter used for the analog output of the monitor selected with H2-20 [Comparator 1 Monitor Selection].	0.0s (0.0 - 10.0 s)

Note:

For information on the comparator function, refer to [66: Comparator1 on page 882](#) and [67: Comparator2 on page 883](#).

■ H2-33: Comparator1 Protection Selection

No. (Hex.)	Name	Description	Default (Range)
H2-33 (159B)	Comparator1 Protection Selection	<div style="display: flex; justify-content: space-between; gap: 5px;"> V/f CL-V/f OLV CLV AOLV OLV/PM AOLV/PM CLV/PM EZOLV </div> Sets drive operation when it detects CP1 [Comparator1 Limit Fault].	4 (0 - 4)

0 : Ramp to Stop

The drive ramps the motor to stop in the deceleration time. Fault relay output terminal MA-MC turns ON, and MB-MC turns OFF.

1 : Coast to Stop

The output turns off and the motor coasts to stop. Fault relay output terminal MA-MC turns ON, and MB-MC turns OFF.

2 : Fast Stop (Use C1-09)

The drive stops the motor in the deceleration time set in C1-09 [Fast Stop Time]. Fault relay output terminal MA-MC turns ON, and MB-MC turns OFF.

3 : Alarm Only

The keypad shows CP1 and the drive continues operation at the current frequency reference.

Note:

The output terminal set for Alarm [H2-01 to H2-03 = 10] activates.

4 : Digital Output Only

■ H2-34: Comparator 2 Filter Time

No. (Hex.)	Name	Description	Default (Range)
H2-34 (159C)	Comparator 2 Filter Time	<div style="display: flex; justify-content: space-between; gap: 5px;"> V/f CL-V/f OLV CLV AOLV OLV/PM AOLV/PM CLV/PM EZOLV </div> Sets the time constant that is applied to the primary delay filter used for the analog output of the monitor selected with H2-26 [Comparator 2 Monitor Selection].	0.0s (0.0 - 10.0 s)

■ H2-35: Comparator2 Protection Selection

No. (Hex.)	Name	Description	Default (Range)
H2-35 (159D)	Comparator2 Protection Selection	<div style="display: flex; justify-content: space-between; gap: 5px;"> V/f CL-V/f OLV CLV AOLV OLV/PM AOLV/PM CLV/PM EZOLV </div> Sets drive operation when it detects CP2 [Comparator2 Limit Fault].	4 (0 - 4)

0 : Ramp to Stop

The drive ramps the motor to stop in the deceleration time. Fault relay output terminal MA-MC turns ON, and MB-MC turns OFF.

1 : Coast to Stop

The output turns off and the motor coasts to stop. Fault relay output terminal MA-MC turns ON, and MB-MC turns OFF.

2 : Fast Stop (Use C1-09)

The drive stops the motor in the deceleration time set in C1-09 [Fast Stop Time]. Fault relay output terminal MA-MC turns ON, and MB-MC turns OFF.

3 : Alarm Only

The keypad shows CP2 and the drive continues operation at the current frequency reference.

Note:

The output terminal set for Alarm [H2-01 to H2-03 = 10] activates.

4 : Digital Output Only

■ H2-36: Comparator 1 Ineffective Time

No. (Hex.)	Name	Description	Default (Range)
H2-36 (159E)	Comparator 1 Ineffective Time	V/f CL-V/f OLV CLV AOLV OLV/PM AOLV/PM CLV/PM EZOLV Sets the length of time that CP1 [Comparator1 Limit Fault] is disabled.	0.0 s (0.0 - 1000.0 s)

Note:

- After you enter a Run command and wait for the time set in this parameter, the drive will monitor operation and make sure that it is in the Comparator 1 range until you enter the Stop command.
- When CP1 detection is disabled, the drive will activate the output terminal set for *Comparator 1* [H2-xx = 66].

■ H2-37: Comparator 2 Ineffective Time

No. (Hex.)	Name	Description	Default (Range)
H2-37 (159F)	Comparator 2 Ineffective Time	V/f CL-V/f OLV CLV AOLV OLV/PM AOLV/PM CLV/PM EZOLV Sets the length of time that CP2 [Comparator2 Limit Fault] is disabled.	0.0 s (0.0 - 1000.0 s)

Note:

- After you enter a Run command and wait for the time set in this parameter, the drive will monitor operation and make sure that it is in the Comparator 2 range until you enter the Stop command.
- When CP2 detection is disabled, the drive will activate the output terminal set for *Comparator 2* [H2-xx = 67].

■ H2-40: Mbus Reg 15E0h bit0 Output Func

No. (Hex.)	Name	Description	Default (Range)
H2-40 (0B58)	Mbus Reg 15E0h bit0 Output Func	V/f CL-V/f OLV CLV AOLV OLV/PM AOLV/PM CLV/PM EZOLV Sets the MFDO for bit 0 of MEMOBUS register 15E0 (Hex.).	F (0 - 1FF)

■ H2-41: Mbus Reg 15E0h bit1 Output Func

No. (Hex.)	Name	Description	Default (Range)
H2-41 (0B59)	Mbus Reg 15E0h bit1 Output Func	V/f CL-V/f OLV CLV AOLV OLV/PM AOLV/PM CLV/PM EZOLV Sets the MFDO for bit 1 of MEMOBUS register 15E0 (Hex.).	F (0 - 1FF)

■ H2-42: Mbus Reg 15E0h bit2 Output Func

No. (Hex.)	Name	Description	Default (Range)
H2-42 (0B5A)	Mbus Reg 15E0h bit2 Output Func	V/f CL-V/f OLV CLV AOLV OLV/PM AOLV/PM CLV/PM EZOLV Sets the MFDO for bit 2 of MEMOBUS register 15E0 (Hex.).	F (0 - 1FF)

■ H2-60: Term M1-M2 Secondary Function

No. (Hex.)	Name	Description	Default (Range)
H2-60 (1B46) Expert	Term M1-M2 Secondary Function	V/f CL-V/f OLV CLV AOLV OLV/PM AOLV/PM CLV/PM EZOLV Sets the second function for terminal M1-M2. Outputs the logical calculation results of the terminals assigned to functions by H2-01 [Term M1-M2 Function Selection].	F (0 - FF)

■ H2-61: Terminal M1-M2 Logical Operation

No. (Hex.)	Name	Description	Default (Range)
H2-61 (1B47) Expert	Terminal M1-M2 Logical Operation	V/f CL-V/f OLV CLV AOLV OLV/PM AOLV/PM CLV/PM EZOLV Sets the logical operation for the functions set in H2-01 [Term M1-M2 Function Selection] and H2-60 [Term M1-M2 Secondary Function].	0 (0 - 8)

Note:

Refer to [Output of Logical Operation Results of MFDO on page 862](#) for more information about the relation between parameter settings and logical operations.

■ H2-62: Terminal M1-M2 Delay Time

No. (Hex.)	Name	Description	Default (Range)
H2-62 (1B48) Expert	Terminal M1-M2 Delay Time	V/f CL-V/f OLV CLV AOLV OLV/PM AOLV/PM CLV/PM EZOLV Sets the minimum on time used to output the logical calculation results from terminal M1-M2.	0.1 s (0.0 - 25.0 s)

■ H2-63: Term M3-M4 Secondary Function

No. (Hex.)	Name	Description	Default (Range)
H2-63 (1B49) Expert	Term M3-M4 Secondary Function	V/f CL-V/f OLV CLV AOLV OLV/PM AOLV/PM CLV/PM EZOLV Sets the second function for terminal M3-M4. Outputs the logical calculation results of the terminals assigned to functions by H2-02 [Term M3-M4 Function Selection].	F (0 - FF)

■ H2-64: Terminal M3-M4 Logical Operation

No. (Hex.)	Name	Description	Default (Range)
H2-64 (1B4A) Expert	Terminal M3-M4 Logical Operation	V/f CL-V/f OLV CLV AOLV OLV/PM AOLV/PM CLV/PM EZOLV Sets the logical operation for the functions set in H2-02 [Term M3-M4 Function Selection] and H2-63 [Term M3-M4 Secondary Function].	0 (0 - 8)

Note:

Refer to [Output of Logical Operation Results of MFDO on page 862](#) for more information about the relation between parameter settings and logical operations.

■ H2-65: Terminal M3-M4 Delay Time

No. (Hex.)	Name	Description	Default (Range)
H2-65 (1B4B) Expert	Terminal M3-M4 Delay Time	V/f CL-V/f OLV CLV AOLV OLV/PM AOLV/PM CLV/PM EZOLV Sets the minimum on time used to output the logical calculation results from terminal M3-M4.	0.1 s (0.0 - 25.0 s)

■ H2-66: Term M5-M6 Secondary Function

No. (Hex.)	Name	Description	Default (Range)
H2-66 (1B4C) Expert	Term M5-M6 Secondary Function	V/f CL-V/f OLV CLV AOLV OLV/PM AOLV/PM CLV/PM EZOLV Sets the second function for terminal M5-M6. Outputs the logical calculation results of the terminals assigned to functions by H2-03 [Terminal M5-M6 Function Select].	F (0 - FF)

■ H2-67: Terminal M5-M6 Logical Operation

No. (Hex.)	Name	Description	Default (Range)
H2-67 (1B4D) Expert	Terminal M5-M6 Logical Operation	V/f CL-V/f OLV CLV AOLV OLV/PM AOLV/PM CLV/PM EZOLV Sets the logical operation for the functions set in H2-03 [Term M5-M6 Function Selection] and H2-66 [Term M5-M6 Secondary Function].	0 (0 - 8)

Note:

Refer to [Output of Logical Operation Results of MFDO on page 862](#) for more information about the relation between parameter settings and logical operations.

■ H2-68: Terminal M5-M6 Delay Time

No. (Hex.)	Name	Description	Default (Range)
H2-68 (1B4E) Expert	Terminal M5-M6 Delay Time	V/f CL-V/f OLV CLV AOLV OLV/PM AOLV/PM CLV/PM EZOLV Sets the minimum on time used to output the logical calculation results from terminal M5-M6.	0.1 s (0.0 - 25.0 s)

◆ MFDO Setting Values

Selects the function configured to MFDO.

■ 0: During Run

Setting Value	Function	Description
0	During Run	V/f CL-V/f OLV CLV AOLV OLV/PM AOLV/PM CLV/PM EZOLV The terminal activates when you input a Run command and when the drive is outputting voltage.

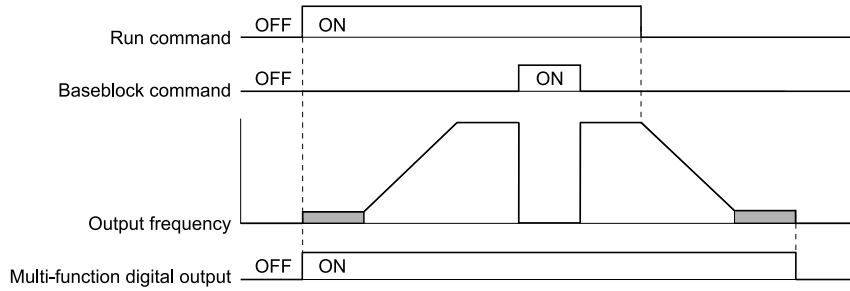

Figure 12.92 Drive Running Time Chart

ON : Drive is running

The drive is receiving a Run command or outputting voltage.

OFF : Drive is stopping

■ 1: Zero Speed

Setting Value	Function	Description
1	Zero Speed	V/f CL-V/f OLV CLV AOLV OLV/PM AOLV/PM CLV/PM EZOLV The terminal activates when the output frequency < E1-09 [Minimum Output Frequency] or b2-01 [DC Injection/Zero SpeedThreshold].

Note:

Parameter A1-02 [Control Method Selection] selects which parameter is the reference.

A1-02 Setting	Control method selection	Parameter Used as the Reference
0	V/f Control	E1-09
1	V/f Control with Encoder	E1-09
2	Open Loop Vector	b2-01
3	Closed Loop Vector	E1-09
4	Advanced OpenLoop Vector Control	E1-09
5	PM Open Loop Vector	E1-09
6	PM Advanced Open Loop Vector	E1-09
7	PM Closed Loop Vector Control	b2-01
8	EZ Open Loop Vector Control	E1-09

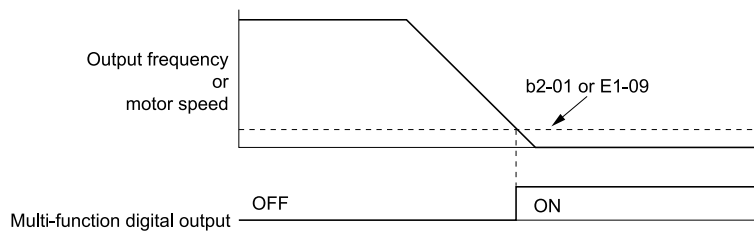

Figure 12.93 Zero Speed Time Chart

ON : Output frequency < value of E1-09 or b2-01.

OFF : Output frequency ≥ value of E1-09 or b2-01.

■ 2: Speed Agree 1

Setting Value	Function	Description
2	Speed Agree 1	V/f CL-V/f OLV CLV AOLV OLV/PM AOLV/PM CLV/PM EZOLV The terminal turns on when the output frequency is in the range of the frequency reference ± L4-02 [Speed Agree Detection Width].

Note:

- The detection function operates in the two motor rotation directions.
- The drive outputs the motor speed status when $A1-02 = 3, 7$ [CLV, CLV/PM]. It also outputs the motor speed status when $A1-02 = 4$ and $n4-72 = 1$.

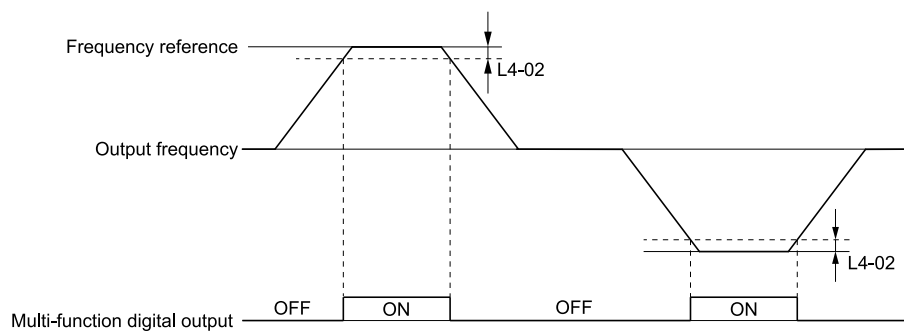

Figure 12.94 Speed Agree 1 Time Chart

ON : The output frequency is in the range of “frequency reference $\pm L4-02$ ”.

OFF : The output frequency does not align with the frequency reference although the drive is running.

■ **3: User-Set Speed Agree 1**

Setting Value	Function	Description
3	User-Set Speed Agree 1	<div style="display: flex; justify-content: space-between; font-size: small;"> V/f CL-V/f OLV CLV AOLV OLV/PM AOLV/PM CLV/PM EZOLV </div> <p>The terminal activates when the output frequency is in the range of $L4-01$ [Speed Agree Detection Level] $\pm L4-02$ [Speed Agree Detection Width] and in the range of the frequency reference $\pm L4-02$.</p>

Note:

- The detection function operates in the two motor rotation directions. The drive uses the $L4-01$ value as the forward/reverse detection level.
- The drive outputs the motor speed status when $A1-02 = 3, 7$ [CLV, CLV/PM]. It also outputs the motor speed status when $A1-02 = 4$ and $n4-72 = 1$.

ON : The output frequency is in the range of “ $L4-01 \pm L4-02$ ” and the range of frequency reference $\pm L4-02$.

OFF : The output frequency is not in the range of “ $L4-01 \pm L4-02$ ” or the range of frequency reference $\pm L4-02$.

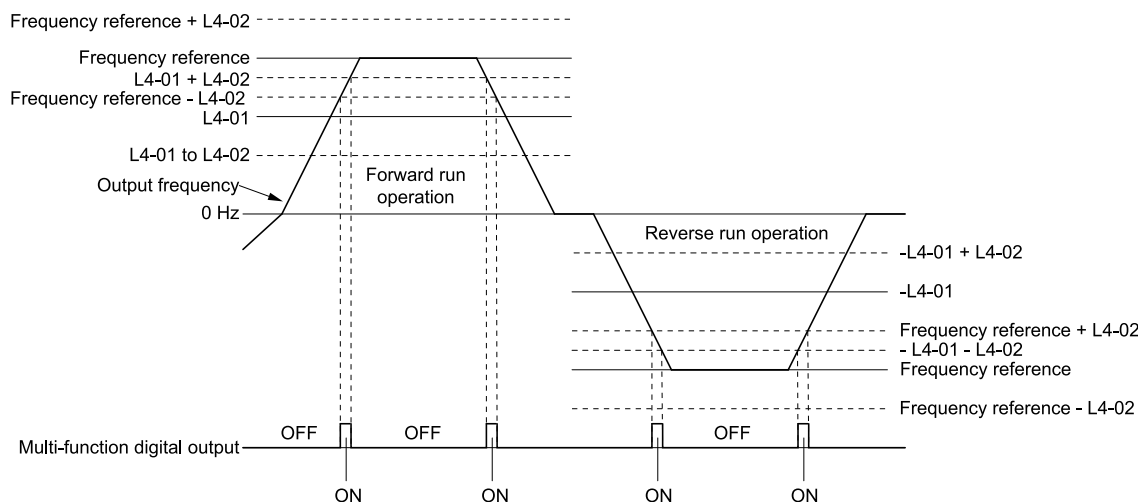

Figure 12.95 User-Defined Speed Agree 1 Time Chart

■ **4: Frequency Detection 1**

Setting Value	Function	Description
4	Frequency Detection 1	<div style="display: flex; justify-content: space-between; font-size: small;"> V/f CL-V/f OLV CLV AOLV OLV/PM AOLV/PM CLV/PM EZOLV </div> <p>The terminal deactivates when the output frequency $> L4-01$ [Speed Agree Detection Level] $+ L4-02$ [Speed Agree Detection Width]. After the terminal deactivates, the terminal stays deactivated until the output frequency is at the value of $L4-01$.</p>

Note:

- The detection function operates in the two motor rotation directions. The drive uses the *L4-01* value as the forward/reverse detection level.
- The drive outputs the motor speed status when *A1-02* = 3, 7 [*CLV, CLV/PM*]. It also outputs the motor speed status when *A1-02* = 4 and *n4-72* = 1.

ON : The output frequency is less than the value of *L4-01* or does not exceed the value of *L4-01* + *L4-02*.

OFF : The output frequency > *L4-01* + *L4-02*.

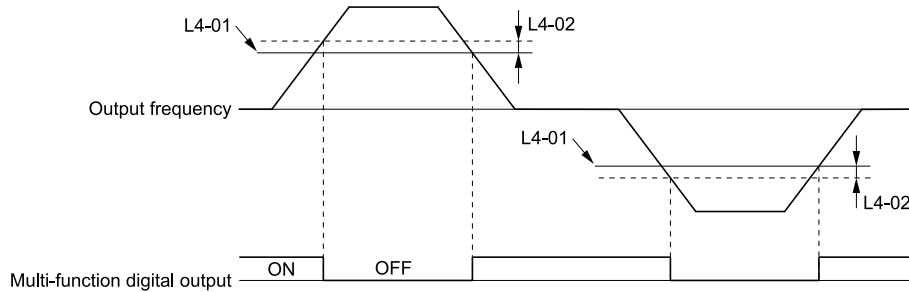

Figure 12.96 Frequency Detection 1 Time Chart

Note:

Figure 12.96 shows the result of the configuration when *L4-07* = 1 [*Speed Agree Detection Selection = Detection Always Enabled*]. The default setting of *L4-07* is 0 [*No detection during baseblock*]. When the speed agreement detection selection is “No Detection during Baseblock”, the terminal is deactivated when the drive output stops.

■ 5: Frequency Detection 2

Setting Value	Function	Description
5	Frequency Detection 2	<div style="display: flex; justify-content: space-between; font-size: small;"> V/f CL-V/f OLV CLV AOLV OLV/PM AOLV/PM CLV/PM EZOLV </div> <p>The terminal activates when the output frequency > <i>L4-01</i> [<i>Speed Agree Detection Level</i>]. After the terminal activates, the terminal stays activated until the output frequency is at the value of “<i>L4-01</i> - <i>L4-02</i>”.</p>

Note:

- The detection function operates in the two motor rotation directions. The drive uses the *L4-01* value as the forward/reverse detection level.
- The drive outputs the motor speed status when *A1-02* = 3, 7 [*CLV, CLV/PM*]. It also outputs the motor speed status when *A1-02* = 4 and *n4-72* = 1.

ON : The output frequency is higher than the value of *L4-01*.

OFF : The output frequency < “*L4-01* - *L4-02*”, or \leq *L4-01*.

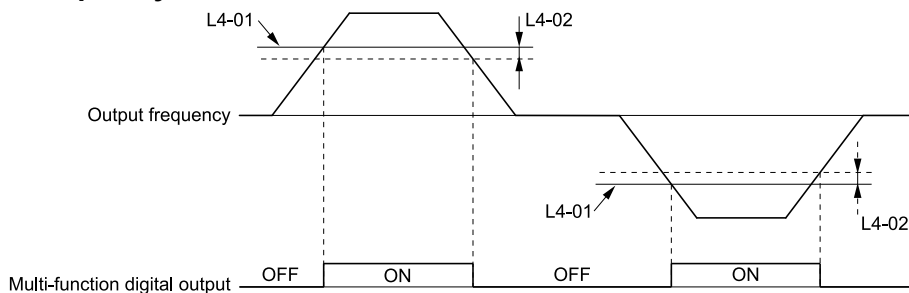

Figure 12.97 Frequency Detection 2 Time Chart

■ 6: Drive Ready

Setting Value	Function	Description
6	Drive Ready	<div style="display: flex; justify-content: space-between; font-size: small;"> V/f CL-V/f OLV CLV AOLV OLV/PM AOLV/PM CLV/PM EZOLV </div> <p>The terminal activates when the drive is ready and running.</p>

The terminal deactivates in these conditions:

- When the power supply is OFF
- During a fault
- When there is problem with the control power supply
- When there is a parameter setting error and the drive cannot operate although there is a Run command

- When you enter a Run command and it immediately triggers an overvoltage or undervoltage fault because the drive has an overvoltage or undervoltage fault during stop
- When the drive is in Programming Mode and will not accept a Run command
- When the Safe Disable function is active

■ 7: DC Bus Undervoltage

Setting Value	Function	Description
7	DC Bus Undervoltage	V/f CL-V/f OLV CLV AOLV OLV/PM AOLV/PM CLV/PM EZOLV The terminal activates when the DC bus voltage or control circuit power supply is at the voltage set in L2-05 [Undervoltage Detection Lvl (Uv1)] or less. The terminal also activates when there is a fault with the DC bus voltage.

ON : The DC bus voltage \leq L2-05

OFF : The DC bus voltage $>$ L2-05

■ 8: During Baseblock (N.O.)

Setting Value	Function	Description
8	During Baseblock (N.O.)	V/f CL-V/f OLV CLV AOLV OLV/PM AOLV/PM CLV/PM EZOLV The terminal activates during baseblock. When the drive is in baseblock, the drive output transistor stops switching and does not make DC bus voltage.

ON : During baseblock

OFF : The drive is not in baseblock.

■ 9: Frequency Reference from Keypad

Setting Value	Function	Description
9	Frequency Reference from Keypad	V/f CL-V/f OLV CLV AOLV OLV/PM AOLV/PM CLV/PM EZOLV Shows the selected frequency reference source.

ON : The keypad is the frequency reference source.

OFF : b1-01 or b1-15 [Frequency Reference Selection 1 or 2] is the frequency reference source.

■ A: Run Command from Keypad

Setting Value	Function	Description
A	Run Command Source	V/f CL-V/f OLV CLV AOLV OLV/PM AOLV/PM CLV/PM EZOLV Shows the selected Run command source.

ON : The keypad is the Run command source.

OFF : b1-02 or b1-16 [Run Command Selection 1 or 2] is the Run command source.

■ B: Torque Detection 1 (N.O.)

Setting Value	Function	Description
B	Torque Detection 1 (N.O.)	V/f CL-V/f OLV CLV AOLV OLV/PM AOLV/PM CLV/PM EZOLV The terminal activates when the drive detects overtorque or undertorque.

ON : The output current/torque $>$ L6-02 [Torque Detection Level 1], or the output current/torque $<$ L6-02 for longer than the time set in L6-03 [Torque Detection Time 1].

Note:

- When L6-01 \geq 5, the drive will detect when the output current/torque is less than L6-02 for longer than L6-03.
- Refer to L6: Torque Detection on page 940 for more information.

■ C: Frequency Reference Loss

Setting Value	Function	Description
C	Frequency Reference Loss	V/f CL-V/f OLV CLV AOLV OLV/PM AOLV/PM CLV/PM EZOLV The terminal activates when the drive detects a loss of frequency reference.

Note:

Refer to "L4-05: Fref Loss Detection Selection" for more information.

■ D: Braking Resistor Fault

Setting Value	Function	Description
D	Braking Resistor Fault	<div style="display: flex; justify-content: space-between; gap: 5px;"> V/f CL-V/f OLV CLV AOLV OLV/PM AOLV/PM CLV/PM EZOLV </div> <p>The terminal activates when the mounting-type braking resistor is overheating or when there is a braking transistor fault.</p>

■ E: Fault

Setting Value	Function	Description
E	Fault	<div style="display: flex; justify-content: space-between; gap: 5px;"> V/f CL-V/f OLV CLV AOLV OLV/PM AOLV/PM CLV/PM EZOLV </div> <p>The terminal activates when the drive detects a fault.</p>

Note:

The terminal will not activate for *CPF00* and *CPF01* [Control Circuit Error] faults.

■ F: Not Used

Setting Value	Function	Description
F	Not Used	<div style="display: flex; justify-content: space-between; gap: 5px;"> V/f CL-V/f OLV CLV AOLV OLV/PM AOLV/PM CLV/PM EZOLV </div> <p>Use this setting for unused terminals or to use terminals in through mode. Also use this setting as the PLC contact output via MEMOBUS/Modbus or the communication option. This signal does not function if you do not configure signals from the PLC.</p>

■ 10: Alarm

Setting Value	Function	Description
10	Alarm	<div style="display: flex; justify-content: space-between; gap: 5px;"> V/f CL-V/f OLV CLV AOLV OLV/PM AOLV/PM CLV/PM EZOLV </div> <p>The terminal activates when the drive detects a minor fault.</p>

■ 11: Fault Reset Command Active

Setting Value	Function	Description
11	Fault Reset Command Active	<div style="display: flex; justify-content: space-between; gap: 5px;"> V/f CL-V/f OLV CLV AOLV OLV/PM AOLV/PM CLV/PM EZOLV </div> <p>The terminal activates when the drive receives the Reset command from the control circuit terminal, serial communications, or the communication option.</p>

■ 12: Timer Output

Setting Value	Function	Description
12	Timer Output	<div style="display: flex; justify-content: space-between; gap: 5px;"> V/f CL-V/f OLV CLV AOLV OLV/PM AOLV/PM CLV/PM EZOLV </div> <p>Sets the terminal as the timer output. Use this setting with the timer input set in <i>H1-xx = 18</i> [MFDI Function Selection = Timer Function].</p>

Note:

Refer to [Timer Function Operation on page 705](#) for more information.

■ 13: Speed Agree 2

Setting Value	Function	Description
13	Speed Agree 2	<div style="display: flex; justify-content: space-between; gap: 5px;"> V/f CL-V/f OLV CLV AOLV OLV/PM AOLV/PM CLV/PM EZOLV </div> <p>The terminal activates when the output frequency is in the range of the frequency reference $\pm L4-04$ [Speed Agree Detection Width (+/-)].</p>

Note:

- The detection function operates in the two motor rotation directions.
- The drive outputs the motor speed status when *A1-02 = 3, 7* [Control Method Selection = *CLV, CLV/PM*].

ON : The output frequency is in the range of “frequency reference $\pm L4-04$ ”.

OFF : The output frequency is not in the range of “frequency reference $\pm L4-04$ ”.

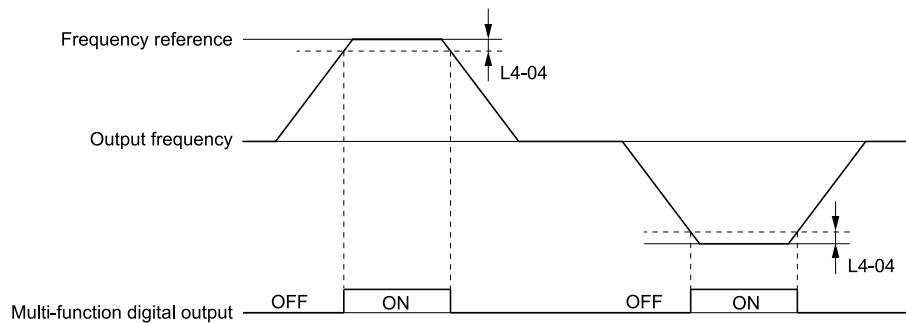

Figure 12.98 Speed Agree 2 Time Chart

14: User-Set Speed Agree 2

Setting Value	Function	Description
14	User-Set Speed Agree 2	<div style="display: flex; justify-content: space-between; font-size: small;"> V/f CL-V/f OLV CLV AOLV OLV/PM AOLV/PM CLV/PM EZOLV </div> <p>The terminal activates when the output frequency is in the range of $L4-03$ [Speed Agree Detection Level (+/-)] $\pm L4-04$ [Speed Agree Detection Width (+/-)] and in the range of the frequency reference $\pm L4-04$.</p>

Note:

- The detection level set in $L4-03$ is a signed value. The drive will only detect in one direction.
- The drive outputs the motor speed status when $A1-02 = 3, 7$ [Control Method Selection = CLV, CLV/PM].

ON : The output frequency is in the range of “ $L4-03 \pm L4-04$ ” and the range of frequency reference $\pm L4-04$.

OFF : The output frequency is not in the range of “ $L4-03 \pm L4-04$ ” or the range of frequency reference $\pm L4-04$.

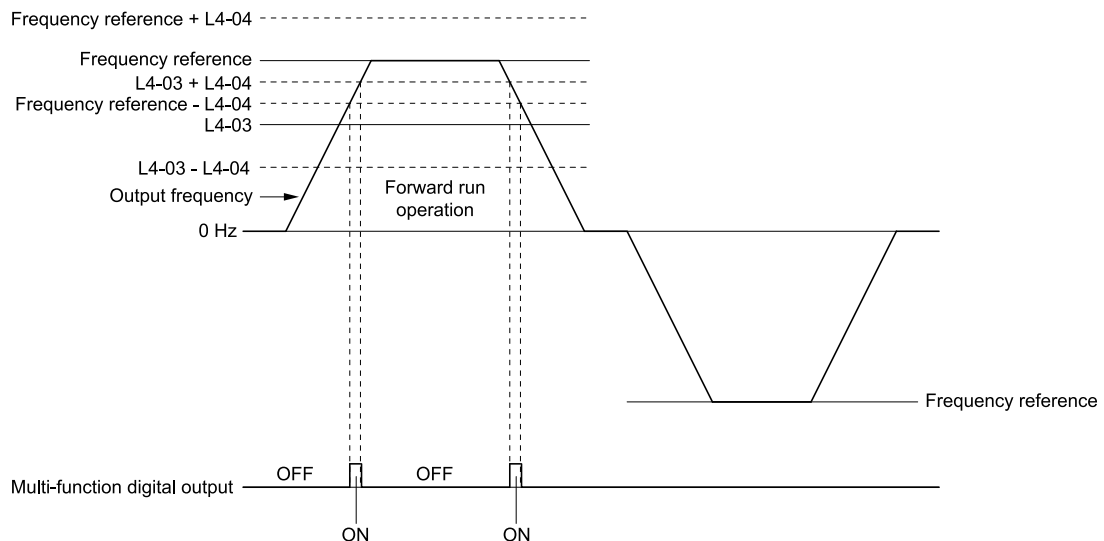

Figure 12.99 Example of User-set Speed Agree 2 (L4-03 Is Positive)

15: Frequency Detection 3

Setting Value	Function	Description
15	Frequency Detection 3	<div style="display: flex; justify-content: space-between; font-size: small;"> V/f CL-V/f OLV CLV AOLV OLV/PM AOLV/PM CLV/PM EZOLV </div> <p>The terminal deactivates when the output frequency $> L4-03$ [Speed Agree Detection Level(+/-)] $+ L4-04$ [Speed Agree Detection Width(+/-)]. After the terminal deactivates, the terminal stays deactivated until the output frequency is at the value of $L4-03$.</p>

Note:

- The detection level set in $L4-03$ is a signed value. The drive will only detect in one direction.
- The drive outputs the motor speed status when $A1-02 = 3, 7$ [Control Method Selection = CLV, CLV/PM].

ON : The output frequency is less than the value of $L4-03$ or is not higher than the value of $L4-03 + L4-04$.

OFF : The output frequency is higher than the value of $L4-03 + L4-04$.

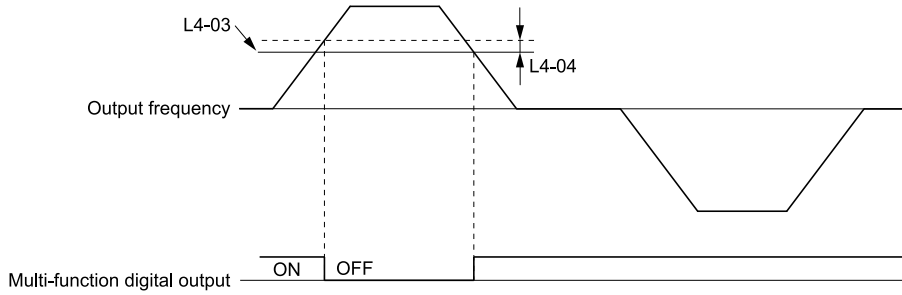

Figure 12.100 Example of Frequency Detection 3 (value of L4-03 Is Positive)

Note:

Figure 12.100 shows the time chart when $L4-07 = 1$ [Speed Agree Detection Selection = Detection Always Enabled]. The default setting of $L4-07$ is 0 [No detection during baseblock]. When the speed agreement detection selection is “No Detection during Baseblock”, the terminal is deactivated when the drive output stops.

■ **16: Frequency Detection 4**

Setting Value	Function	Description
16	Frequency Detection 4	V/f CL-V/f OLV CLV AOLV OLV/PM AOLV/PM CLV/PM EZOLV The terminal activates when the output frequency $> L4-03$ [Speed Agree Detection Level(+/-)]. After the terminal activates, the terminal stays activated until the output frequency is at the value of “ $L4-03 - L4-04$ ”.

Note:

- The detection level set in $L4-03$ is a signed value. The drive will only detect in one direction.
- The drive outputs the motor speed status if $A1-02 = 3, 7$ [Control Method Selection = CLV, CLV/PM].

ON : The output frequency is higher than the value of $L4-03$.

OFF : The output frequency is less than the value of “ $L4-03 - L4-04$ ”, or it is not higher than the value of $L4-03$.

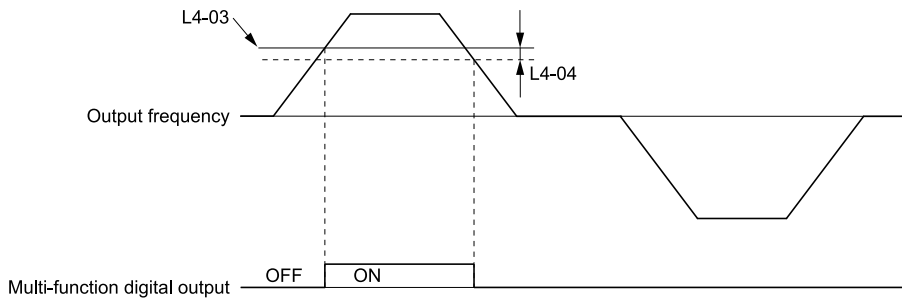

Figure 12.101 Example of Frequency Detection 4 (value of L4-03 Is Positive)

■ **17: Torque Detection 1 (N.C.)**

Setting Value	Function	Description
17	Torque Detection 1 (N.C.)	V/f CL-V/f OLV CLV AOLV OLV/PM AOLV/PM CLV/PM EZOLV The terminal deactivates when the drive detects overtorque or undertorque.

Use the $L6$ [Torque Detection] parameters to set torque detection.

OFF : The output current/torque $> L6-02$ [Torque Detection Level 1], or the output current/torque $< L6-02$ for longer than the time set in $L6-03$ [Torque Detection Time 1].

Note:

- When $L6-01 \geq 5$, the drive will detect when the output current/torque is less than $L6-02$ for longer than $L6-03$.
- Refer to [L6: Torque Detection on page 940](#) for more information.

■ **18: Torque Detection 2 (N.O.)**

Setting Value	Function	Description
18	Torque Detection 2 (N.O.)	V/f CL-V/f OLV CLV AOLV OLV/PM AOLV/PM CLV/PM EZOLV The terminal activates when the drive detects overtorque or undertorque.

Use the $L6$ [Torque Detection] parameters to set torque detection.

ON : The output current/torque $> L6-05$ [Torque Detection Level 2], or the output current/torque $< L6-05$ for longer than the time set in $L6-06$ [Torque Detection Time 2].

Note:

- When $L6-04 \geq 5$, the drive will detect when the output current/torque is less than $L6-05$ for longer than $L6-06$.
- Refer to [L6: Torque Detection on page 940](#) for more information.

■ 19: Torque Detection 2 (N.C.)

Setting Value	Function	Description
19	Torque Detection 2 (N.C.)	<div style="display: flex; justify-content: space-between; align-items: center;"> V/f CL-V/f OLV CLV AOLV OLV/PM AOLV/PM CLV/PM EZOLV </div> <p>The terminal deactivates when the drive detects overtorque or undertorque.</p>

Use the $L6$ [Torque Detection] parameters to set torque detection.

OFF : The output current/torque $> L6-05$ [Torque Detection Level 2], or the output current/torque $< L6-05$ for longer than the time set in $L6-06$ [Torque Detection Time 2].

Note:

- When $L6-04 \geq 5$, the drive will detect when the output current/torque is less than $L6-05$ for longer than $L6-06$.
- Refer to [L6: Torque Detection on page 940](#) for more information.

■ 1A: During Reverse

Setting Value	Function	Description
1A	During Reverse	<div style="display: flex; justify-content: space-between; align-items: center;"> V/f CL-V/f OLV CLV AOLV OLV/PM AOLV/PM CLV/PM EZOLV </div> <p>The terminal activates when the motor operates in the reverse direction.</p>

ON : The motor is operating in the reverse direction.

OFF : The motor is operating in the forward direction or the motor stopped.

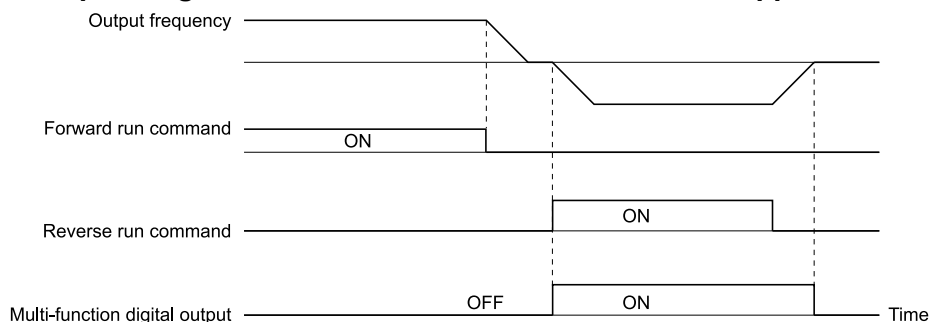

Figure 12.102 Reverse Operation Output Time Chart

■ 1B: During Baseblock (N.C.)

Setting Value	Function	Description
1B	During Baseblock (N.C.)	<div style="display: flex; justify-content: space-between; align-items: center;"> V/f CL-V/f OLV CLV AOLV OLV/PM AOLV/PM CLV/PM EZOLV </div> <p>The terminal deactivates during baseblock. When the drive is in baseblock, the drive output transistor stops switching and does not make DC bus voltage.</p>

ON : The drive is not in baseblock.

OFF : During baseblock

■ 1C: Motor 2 Selected

Setting Value	Function	Description
1C	Motor 2 Selected	<div style="display: flex; justify-content: space-between; align-items: center;"> V/f CL-V/f OLV CLV AOLV OLV/PM AOLV/PM CLV/PM EZOLV </div> <p>The terminal activates when you select motor 2.</p>

ON : Motor 2 Selected

OFF : Motor 1 Selected

■ 1D: During Regeneration

Setting Value	Function	Description
1D	During Regeneration	<div style="display: flex; justify-content: space-between; align-items: center;"> V/f CL-V/f OLV CLV AOLV OLV/PM AOLV/PM CLV/PM EZOLV </div> <p>The terminal activates on when the motor is regenerating.</p>

ON : Motor is regenerating.

OFF : Motor is operating or stopped.

■ 1E: Executing Auto-Restart

Setting Value	Function	Description
1E	Executing Auto-Restart	<div style="display: flex; justify-content: space-between; gap: 5px;"> V/f CL-V/f OLV CLV AOLV OLV/PM AOLV/PM CLV/PM EZOLV </div> <p>The terminal activates when the Auto Restart function is trying to restart after a fault.</p>

The terminal deactivates when the Auto Restart function automatically resets a fault. The terminal deactivates when the Auto Restart function detects the fault again because there were too many restart attempts as specified by L5-01 [Number of Auto Restart Attempts].

Note:

Refer to L5: [Fault Restart on page 937](#) for more information.

■ 1F: Motor Overload Alarm (oL1)

Setting Value	Function	Description
1F	Motor Overload Alarm (oL1)	<div style="display: flex; justify-content: space-between; gap: 5px;"> V/f CL-V/f OLV CLV AOLV OLV/PM AOLV/PM CLV/PM EZOLV </div> <p>The terminal activates when the electronic thermal protection value of the motor overload protective function is a minimum of 90% of the detection level.</p>

Note:

Refer to “L1-01: Motor Overload (oL1) Protection” for more information.

■ 20: Drive Overheat Pre-Alarm (oH)

Setting Value	Function	Description
20	Drive Overheat Pre-Alarm (oH)	<div style="display: flex; justify-content: space-between; gap: 5px;"> V/f CL-V/f OLV CLV AOLV OLV/PM AOLV/PM CLV/PM EZOLV </div> <p>The terminal activates when the drive heatsink temperature is at the level set with L8-02 [Overheat Alarm Level].</p>

Note:

Refer to “L8-02: Overheat Alarm Level” for more information.

■ 21: Safe Torque OFF

Setting Value	Function	Description
21	Safety Monitor Output Status	<div style="display: flex; justify-content: space-between; gap: 5px;"> V/f CL-V/f OLV CLV AOLV OLV/PM AOLV/PM CLV/PM EZOLV </div> <p>The terminal activates (safety stop state) when the safety circuit and safety diagnosis circuit are operating correctly and when terminals H1-HC and H2-HC are OFF (Open).</p>

Note:

EDM = External Device Monitor

ON : Safety stop state

Terminals H1-HC and H2-HC are OFF or released (safety stop state).

OFF : Safety circuit fault or RUN/READY

Terminal H1-HC or terminal H2-HC is OFF or released (safety circuit fault), or the two terminals are ON or short circuited (RUN/READY).

■ 22: Mechanical Weakening Detection

Setting Value	Function	Description
22	Mechanical Weakening Detection	<div style="display: flex; justify-content: space-between; gap: 5px;"> V/f CL-V/f OLV CLV AOLV OLV/PM AOLV/PM CLV/PM EZOLV </div> <p>The terminal activates when the drive detects mechanical weakening.</p>

Note:

Refer to “Mechanical Weakening Detection Function” for more information.

■ 2F: Maintenance Notification

Setting Value	Function	Description
2F	Maintenance Notification	<div style="display: flex; justify-content: space-between; gap: 5px;"> V/f CL-V/f OLV CLV AOLV OLV/PM AOLV/PM CLV/PM EZOLV </div> <p>The terminal activates when drive components are at their estimated maintenance period.</p>

Tells the user about the maintenance period for these items:

- IGBT
- Cooling fan
- Capacitor

- Soft charge bypass relay

Note:

Refer to “Alarm Outputs for Maintenance Monitors” for more information.

■ 30: During Torque Limit

Setting Value	Function	Description
30	During Torque Limit	<div style="display: flex; justify-content: space-between; align-items: center;"> V/f CL-V/f OLV CLV AOLV OLV/PM AOLV/PM CLV/PM EZOLV </div> <p>The terminal activates when the torque reference is the torque limit set with <i>L7</i> parameters, <i>H3-02</i>, <i>H3-06</i>, or <i>H3-10</i> [MFAI Function Selection].</p>

Note:

Refer to “L7: Torque Limit” for more information.

■ 31: During Speed Limit

Setting Value	Function	Description
31	During Speed Limit	<div style="display: flex; justify-content: space-between; align-items: center;"> V/f CL-V/f OLV CLV AOLV OLV/PM AOLV/PM CLV/PM EZOLV </div> <p>The terminal activates when the speed limit is active.</p>

The speed limit activates and the terminal activates in these conditions:

- The frequency reference $\geq d2-01$ [Frequency Reference Upper Limit]
- The frequency reference $\leq d2-02$ [Frequency Reference Lower Limit] or *d2-03* [Analog Frequency Ref Lower Limit].
- The frequency reference $\leq E1-09$ [Minimum Output Frequency] when *b1-05* = 1, 2, or 3 [Operation Below Minimum Freq = Baseblock (Motor Coasts), Operate at Minimum Frequency, or Operate at Zero Speed].
- The frequency reference \leq Output Freq Lower Limit Level [*H3-xx* = 9] through analog input.

■ 32: In Speed Limit During Trq Ctrl

Setting Value	Function	Description
32	In Speed Limit During Trq Ctrl	<div style="display: flex; justify-content: space-between; align-items: center;"> V/f CL-V/f OLV CLV AOLV OLV/PM AOLV/PM CLV/PM EZOLV </div> <p>The motor accelerates in the forward direction or the reverse direction after enabling torque control and the externally input torque reference is disproportionate to the load. The output terminal activates when this speed is not higher than a constant speed and the motor speed is at the speed limit. This does not include operation when the drive is stopped.</p>

Note:

Refer to “d5-03: Speed Limit Selection” for more information.

■ 33: Zero Servo Complete

Setting Value	Function	Description
33	Zero Servo Complete	<div style="display: flex; justify-content: space-between; align-items: center;"> V/f CL-V/f OLV CLV AOLV OLV/PM AOLV/PM CLV/PM EZOLV </div> <p>The terminal activates when positioning in the range set with <i>b9-02</i> [Zero Servo Completion Window] completes after sending the Zero-Servo command.</p>

Note:

Refer to “b9: Zero Servo” for more information.

■ 37: During Frequency Output

Setting Value	Function	Description
37	During Frequency Output	<div style="display: flex; justify-content: space-between; align-items: center;"> V/f CL-V/f OLV CLV AOLV OLV/PM AOLV/PM CLV/PM EZOLV </div> <p>The terminal activates when the drive outputs frequency.</p>

ON : The drive is outputting frequency.

OFF : The drive is not outputting frequency.

Note:

The terminal deactivates in these conditions:

- During Stop
- During Baseblock
- During DC Injection Braking (initial excitation)
- During Short Circuit Braking
- Pole Position Detection Complete

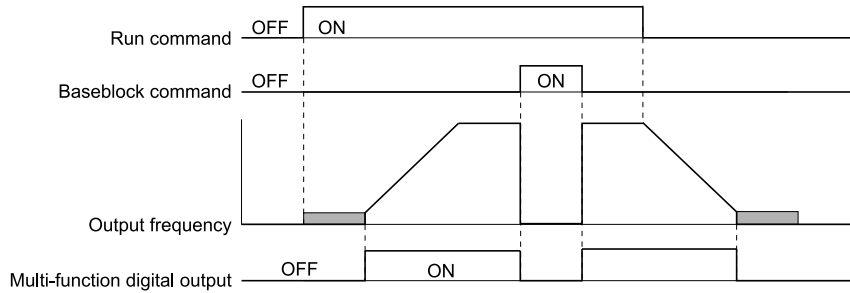

Figure 12.103 Active Frequency Output Time Chart

Note:

Refer to *Notes for Elevator or Lift Applications on page 669* for elevator or lift instructions.

■ **38: Drive Enabled**

Setting Value	Function	Description
38	Drive Enabled	V/f CL-V/f OLV CLV AOLV OLV/PM AOLV/PM CLV/PM EZOLV This terminal activates when the H1-xx = 6A [Drive Enable] terminal activates.

■ **39: Watt Hour Pulse Output**

Setting Value	Function	Description
39	Watt Hour Pulse Output	V/f CL-V/f OLV CLV AOLV OLV/PM AOLV/PM CLV/PM EZOLV Outputs the pulse that shows the watt hours.

Note:

Refer to “H2-06: Watt Hour Output Unit Selection” for more information.

■ **3C: LOCAL Control Selected**

Setting Value	Function	Description
3C	LOCAL Control Selected	V/f CL-V/f OLV CLV AOLV OLV/PM AOLV/PM CLV/PM EZOLV The terminal activates when the Run command source or frequency reference source is LOCAL.

ON : LOCAL

The keypad is the Run command source or the frequency reference source.

OFF : REMOTE

The Run command source or frequency reference source is an external source set with b1-01 [Frequency Reference Selection 1], b1-15 [Frequency Reference Selection 2], b1-02 [Run Command Selection 1], or b1-16 [Run Command Selection 2].

■ **3D: During Speed Search**

Setting Value	Function	Description
3D	During Speed Search	V/f CL-V/f OLV CLV AOLV OLV/PM AOLV/PM CLV/PM EZOLV The terminal activates when the drive is doing speed search.

Note:

Refer to “b3: Speed Search” for more information.

■ **3E: PID Feedback Low**

Setting Value	Function	Description
3E	PID Feedback Low	V/f CL-V/f OLV CLV AOLV OLV/PM AOLV/PM CLV/PM EZOLV The terminal activates when the drive detects FbL [PID Feedback Loss].

The drive detects FbL [PID Feedback Loss] when the PID feedback value < b5-13 [PID Feedback Loss Detection Lv] for longer than b5-14 [PID Feedback Loss Detection Time].

Note:

Refer to *PID Feedback Loss Detection on page 709* for more information.

■ 3F: PID Feedback High

Setting Value	Function	Description
3F	PID Feedback High	<div style="display: flex; justify-content: space-between; align-items: center;"> V/f CL-V/f OLV CLV AOLV OLV/PM AOLV/PM CLV/PM EZOLV </div> <p>The terminal activates when the drive detects <i>FbH</i> [Excessive PID Feedback].</p>

The drive detects *FbH* [Excessive PID Feedback] when the PID feedback value > *b5-36* [PID High Feedback Detection Lvl] for longer than *b5-37* [PID High Feedback Detection Time].

Note:

Refer to [PID Feedback Loss Detection on page 709](#) for more information.

■ 4A: During KEB Ride-Thru

Setting Value	Function	Description
4 A	During KEB Ride-Thru	<div style="display: flex; justify-content: space-between; align-items: center;"> V/f CL-V/f OLV CLV AOLV OLV/PM AOLV/PM CLV/PM EZOLV </div> <p>The activates during KEB Ride-Thru.</p>

Note:

Refer to [KEB Ride-Thru Function on page 917](#) for more information.

■ 4B: During Short Circuit Braking

Setting Value	Function	Description
4B	During Short Circuit Braking	<div style="display: flex; justify-content: space-between; align-items: center;"> V/f CL-V/f OLV CLV AOLV OLV/PM AOLV/PM CLV/PM EZOLV </div> <p>The terminal activates during Short Circuit Braking.</p>

Note:

- When *A1-02* = 8 [Control Method Selection = EZOLV], this function is available only when you use a PM motor.
- Refer to [b2: DC Injection Braking and Short Circuit Braking on page 693](#) for more information.

■ 4C: During Fast Stop

Setting Value	Function	Description
4C	During Fast Stop	<div style="display: flex; justify-content: space-between; align-items: center;"> V/f CL-V/f OLV CLV AOLV OLV/PM AOLV/PM CLV/PM EZOLV </div> <p>The terminal activates when the fast stop is in operation.</p>

■ 4D: oH Pre-Alarm Time Limit

Setting Value	Function	Description
4D	oH Pre-Alarm Time Limit	<div style="display: flex; justify-content: space-between; align-items: center;"> V/f CL-V/f OLV CLV AOLV OLV/PM AOLV/PM CLV/PM EZOLV </div> <p>The terminal activates when <i>L8-03</i> = 4 [Overheat Pre-Alarm Selection = Operate at Reduced Speed (L8-19)] and <i>oH</i> [Heatsink Overheat] does not clear after the drive decreases the frequency for 10 cycles.</p>

Note:

Refer to "L8-03: Overheat Pre-Alarm Ope Selection" for more information about drive derating operation.

■ 4E: Braking Transistor Fault (rr)

Setting Value	Function	Description
4E	Braking Transistor Fault (rr)	<div style="display: flex; justify-content: space-between; align-items: center;"> V/f CL-V/f OLV CLV AOLV OLV/PM AOLV/PM CLV/PM EZOLV </div> <p>The terminal activates when the internal braking transistor overheats and the drive detects an <i>rr</i> [Dynamic Braking Transistor Fault] fault.</p>

■ 4F: Braking Resistor Overheat (rH)

Setting Value	Function	Description
4F	Braking Resistor Overheat (rH)	<div style="display: flex; justify-content: space-between; align-items: center;"> V/f CL-V/f OLV CLV AOLV OLV/PM AOLV/PM CLV/PM EZOLV </div> <p>The terminal activates when the braking resistor overheats and the drive detects an <i>rH</i> [Braking Resistor Overheat] fault.</p>

The braking resistor overheats when the deceleration time is short and there is too much motor regeneration energy.

■ 60: Internal Cooling Fan Failure

Setting Value	Function	Description
60	Internal Cooling Fan Failure	<div style="display: flex; justify-content: space-between; align-items: center;"> V/f CL-V/f OLV CLV AOLV OLV/PM AOLV/PM CLV/PM EZOLV </div> <p>The terminal activates when the drive detects a cooling fan failure in the drive.</p>

■ 61: Pole Position Detection Complete

Setting Value	Function	Description
61	Pole Position Detection Complete	<div style="display: flex; justify-content: space-between; border-bottom: 1px solid black; padding-bottom: 2px;"> V/f CL-V/f OLV CLV AOLV OLV/PM AOLV/PM CLV/PM EZOLV </div> <p>The terminal activates when drive receives a Run command and the drive detects the motor magnetic pole position of the PM motor.</p>

■ 62: Modbus Reg 1 Status Satisfied

Setting Value	Function	Description
62	Modbus Reg 1 Status Satisfied	<div style="display: flex; justify-content: space-between; border-bottom: 1px solid black; padding-bottom: 2px;"> V/f CL-V/f OLV CLV AOLV OLV/PM AOLV/PM CLV/PM EZOLV </div> <p>The terminal activates when the bit specified by H2-08 [Modbus Register 1 Bit Select] for the MEMOBUS register address set with H2-07 [Modbus Register 1 Address Select] activates.</p>

■ 63: Modbus Reg 2 Status Satisfied

Setting Value	Function	Description
63	Modbus Reg 2 Status Satisfied	<div style="display: flex; justify-content: space-between; border-bottom: 1px solid black; padding-bottom: 2px;"> V/f CL-V/f OLV CLV AOLV OLV/PM AOLV/PM CLV/PM EZOLV </div> <p>The terminal activates when the bit specified by H2-10 [Modbus Register 2 Bit Select] for the MEMOBUS register address set with H2-09 [Modbus Register 2 Address Select] activates.</p>

■ 65: Standby Output

Setting Value	Function	Description
65	Standby Output	<div style="display: flex; justify-content: space-between; border-bottom: 1px solid black; padding-bottom: 2px;"> V/f CL-V/f OLV CLV AOLV OLV/PM AOLV/PM CLV/PM EZOLV </div> <p>The terminal deactivates after the drive stops operating and after the time set with b8-51 [Standby Mode Wait Time].</p>

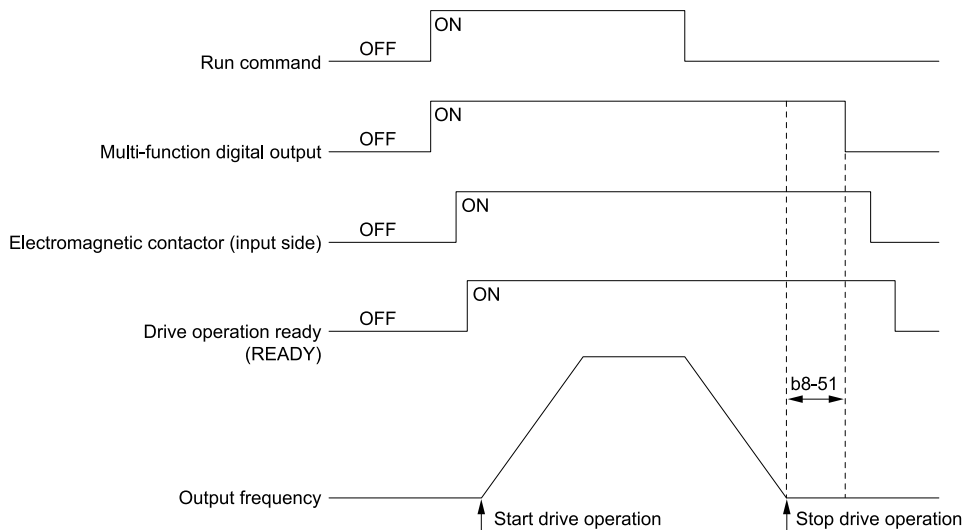

ON : The Run command turns on and the magnetic contactor on the input side turns on.

OFF : The Run command turns off and the drive stops operating. Then, the magnetic contactor on the input side turns off after the time set with b8-51 [Standby Mode Wait Time] elapses.

■ 66: Comparator1

Setting Value	Function	Description
66	Comparator1	<div style="display: flex; justify-content: space-between; border-bottom: 1px solid black; padding-bottom: 2px;"> V/f CL-V/f OLV CLV AOLV OLV/PM AOLV/PM CLV/PM EZOLV </div> <p>The terminal activates if the monitor value set with H2-20 [Comparator 1 Monitor Selection] is in range of the values of H2-21 [Comparator 1 Lower Limit] and H2-22 [Comparator 1 Upper Limit] for the time set in H2-24 [Comparator 1 On-Delay Time].</p>

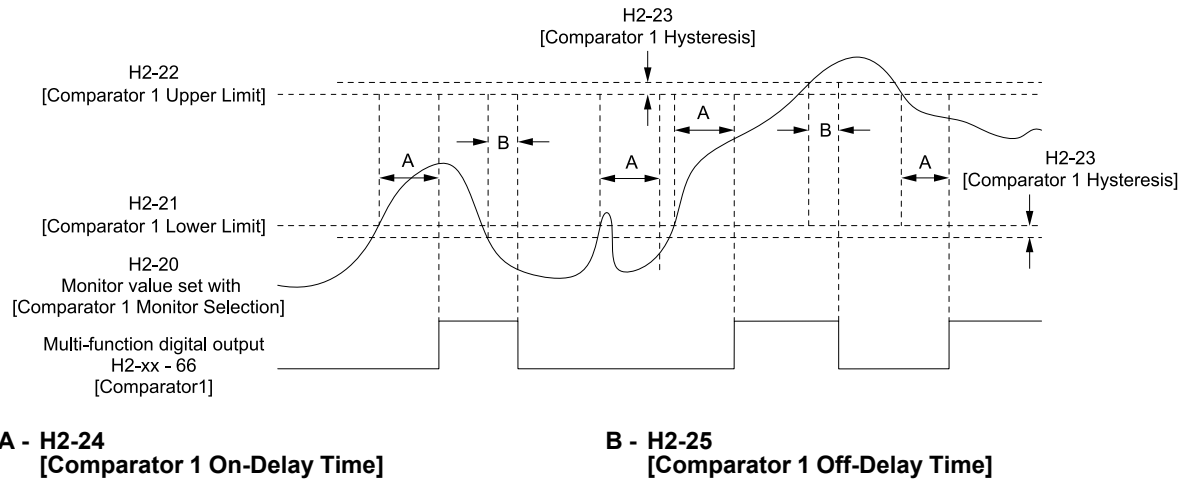

Figure 12.104 Comparator 1 Output Time Chart

Note:
The drive compares the monitors set with H2-20 as absolute values.

■ **67: Comparator2**

Setting Value	Function	Description
67	Comparator2	<p>V/f CL-V/f OLV CLV AOLV OLV/PM AOLV/PM CLV/PM EZOLV</p> <p>The terminal activates if the monitor value set with H2-26 [Comparator 2 Monitor Selection] is not in the range of the values of H2-27 [Comparator 2 Lower Limit] and H2-28 [Comparator 2 Upper Limit] for the time set in H2-30 [Comparator 2 On-Delay Time].</p>

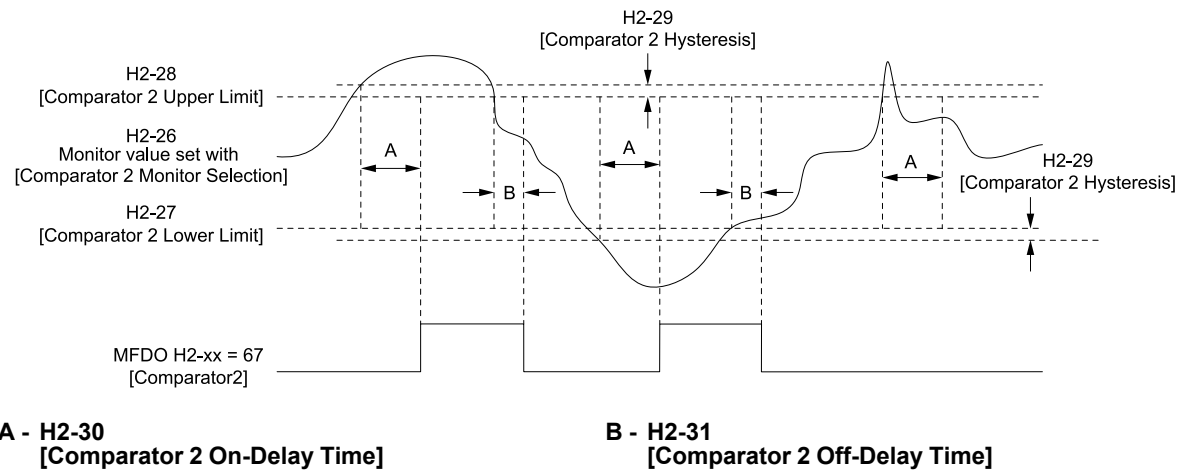

Figure 12.105 Comparator 2 Output Time Chart

Note:
The drive compares the monitors set with H2-26 as absolute values.

■ **69: External Power 24V Supply**

Setting Value	Function	Description
69	External Power 24V Supply	<p>V/f CL-V/f OLV CLV AOLV OLV/PM AOLV/PM CLV/PM EZOLV</p> <p>The terminal activates when there is an external 24V power supply between terminals PS-AC.</p>

ON : The external 24V power supply is supplying power.

OFF : The external 24V power supply is not supplying power.

■ **6A: Data Logger Error**

Setting Value	Function	Description
6 A	Data Logger Error	<p>V/f CL-V/f OLV CLV AOLV OLV/PM AOLV/PM CLV/PM EZOLV</p> <p>The terminal activates when the drive detects a LoG [Com Error / Abnormal SD card].</p>

■ 90 to 93: DWEZ Digital Outputs 1 to 4

Setting Value	Function	Description
90 to 93	DWEZ Digital Outputs 1 to 4	<div style="display: flex; justify-content: space-between; align-items: center;"> V/f CL-V/f OLV CLV AOLV OLV/PM AOLV/PM CLV/PM EZOLV </div> <p>Sets the DriveWorksEZ digital output. Refer to the DriveWorksEZ online manual for more information.</p>

■ A0 to A7: DWEZ Extended Digital Outputs 1 to 8

Setting Value	Function	Description
A0 to A7	DWEZ Extended Digital Outputs 1 to 8	<div style="display: flex; justify-content: space-between; align-items: center;"> V/f CL-V/f OLV CLV AOLV OLV/PM AOLV/PM CLV/PM EZOLV </div> <p>Sets the digital output for the DriveWorksEZ DO-A3 option card. Refer to the DriveWorksEZ online manual for more information.</p>

■ 100 to 1A7: Inverse Outputs of 0 to A7

Setting Value	Function	Description
100 to 1A7	Inverse Outputs of 0 to A7	<div style="display: flex; justify-content: space-between; align-items: center;"> V/f CL-V/f OLV CLV AOLV OLV/PM AOLV/PM CLV/PM EZOLV </div> <p>Causes inverse output of the function for the selected MFDO. Uses the last two digits of 1xx to select which function to inversely output.</p>

For example, set $H2-xx = 10E$ for the inverse output of E [Fault].

◆ H3: Analog Inputs

WARNING! Sudden Movement Hazard. Do test runs and examine the drive to make sure that the command references are correct. If you set the command reference incorrectly, it can cause damage to the drive or serious injury or death.

Drives have three analog input terminals, terminals A1, A2, and A3. *H3 parameters* select the functions set to these analog input terminals and adjust signal levels.

Table 12.71 shows the functions that you can set to analog input terminals. Use *H3-02*, *H3-06*, and *H3-10* [MFAI Function Selection] to set functions.

Table 12.71 MFAI Setting Values

Setting Value	Function	Ref.	Setting Value	Function	Ref.
0	Frequency Reference	890	E	Motor Temperature (PTC Input)	893
1	Frequency Gain	891	F	Not Used	894
2	Auxiliary Frequency Reference 1	891	10	Forward Torque Limit	894
3	Auxiliary Frequency Reference 2	891	11	Reverse Torque Limit	895
4	Output Voltage Bias	891	12	Regenerative Torque Limit	895
5	Accel/Decel Time Gain	892	13	Torque Reference / Torque Limit	895
6	DC Injection Braking Current	892	14	Torque Compensation	895
7	Torque Detection Level	892	15	General Torque Limit	895
8	Stall Prevent Level During Run	892	16	Differential PID Feedback	895
9	Output Frequency Lower Limit	893	1F	Not Used	896
B	PID Feedback	893	30	DWEZ Analog Input 1	896
C	PID Setpoint	893	31	DWEZ Analog Input 2	896
D	Frequency Bias	893	32	DWEZ Analog Input 3	896

Note:

All analog input scaling uses gain and bias for adjustment. Set the gain and bias values correctly.

Example Analog Input Settings	Setting of Terminal A1	Frequency Reference
Frequency reference with the gain setting adjusted	<ul style="list-style-type: none"> H3-02 = 0 [Terminal A1 Function Selection = Frequency Reference] H3-03: 200.0 [Terminal A1 Gain Setting = 200%] H3-04 = 0.0 [Terminal A1 Bias Setting = 0.0%] 	<ul style="list-style-type: none"> When you input a 10 V signal, the frequency reference will be 200%. When you input a 5 V signal, the frequency reference will be 100%. <p>When you input a 5 V or more signal, E1-04 [Maximum Output Frequency] will limit the drive output and the frequency reference will be 100%.</p> <div style="display: flex; justify-content: space-around;"> <div style="text-align: center;"> <p>H3-01 = 0</p> </div> <div style="text-align: center;"> <p>H3-01 = 1</p> </div> </div>
Frequency reference with the negative number bias set	<ul style="list-style-type: none"> H3-02 = 0 [Frequency Reference] H3-03 = 100.0 [100.0%] H3-04 = -25.0 [-25.0%] 	<ul style="list-style-type: none"> When you input a 0 V signal, the frequency reference will be -25%. When H3-01 = 0 [Terminal A1 Signal Level Select = 0 to 10V (Lower Limit at 0)]: <ul style="list-style-type: none"> When you input a 0 V to 2 V signal, the frequency reference will be 0%. When you input a 2 V to 10 V signal, the frequency reference will be 0% to 100%. When H3-01 = 1 [-10 to +10V (Bipolar Reference)]: <ul style="list-style-type: none"> When you input a 0 V to 2 V signal, it enables signals of positive and negative polarities and the motor rotates in reverse. <div style="display: flex; justify-content: space-around;"> <div style="text-align: center;"> <p>H3-01 = 0</p> </div> <div style="text-align: center;"> <p>H3-01 = 1</p> </div> </div>

MEMOBUS/Modbus Multi-Function A1 to 3 Function Selection

Let the MFAI function be assigned to MEMOBUS/Modbus register 15C1 to 15C3 (Hex.) [Mbus Reg 15C1h through 15C3h Input Function]. Use H3-40 to H3-42 [Mbus Reg 15C1h through 15C3h Input Function] to set the function and use H3-43 [Mbus Reg Inputs FilterTime Const] to set the input filter.

Table 12.72 MEMOBUS Multi-Function AI Command Register

Register No. (Hex.)	Name	Range *1	Parameter
15C1	Mbus Reg 15C1h Input Function	-32767 to 32767	H3-40
15C2	Mbus Reg 15C2h Input Function	-32767 to 32767	H3-41
15C3	Mbus Reg 15C3h Input Function	-32767 to 32767	H3-42

*1 Set as 100% = 4096.

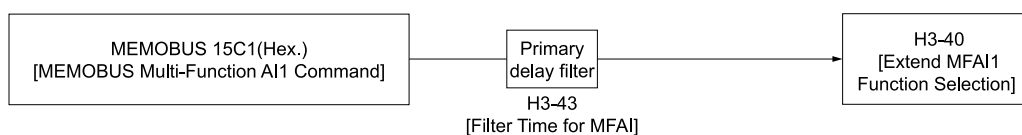

Figure 12.106 Functional Block Diagram for MEMOBUS Multi-Function AI Command 1

Note:

- Refer to H3-xx “MFAI Setting Values” for the analog input setting values.
- When you will not use the terminal, set H3-40 to H3-42 = F. The through mode function is not supported.
- You cannot use H3-40 to H3-42 to set these MFAI terminals:

H3-xx Setting Value	Function
0	Frequency Reference
1	Frequency Gain
2	Auxiliary Frequency Reference 1
3	Auxiliary Frequency Reference 2
30	DWEZ Analog Input 1
31	DWEZ Analog Input 2
32	DWEZ Analog Input 3

■ **H3-01: Terminal A1 Signal Level Select**

No. (Hex.)	Name	Description	Default (Range)
H3-01 (0410)	Terminal A1 Signal Level Select	V/f CL-V/f OLV CLV AOLV OLV/PM AOLV/PM CLV/PM EZOLV Sets the input signal level for MFAI terminal A1.	0 (0 - 3)

0 : 0-10V (Lower Limit at 0)

The voltage signal is 0 Vdc to 10 Vdc. The minimum input level limit is 0%. The drive will read a negative input signal caused by gain and bias settings as 0%.

1 : -10 to +10V (Bipolar Reference)

The voltage signal is -10 Vdc to 10 Vdc. Signals of both positive and negative polarities are enabled. When the drive uses this setting as the frequency reference, a Forward Run command will run the motor in reverse and a Reverse Run command will run the motor forward. The gain and bias settings will cause the signal to be a negative number.

2 : 4 to 20 mA

The current signal is 4 mA to 20 mA. The minimum input level limit is 0%. The minimum input level is limited to 0%, so that a negative input signal due to gain and bias settings will be read as 0%.

3 : 0 to 20 mA

The current signal is 0 mA to 20 mA. The minimum input level limit is 0%. The minimum input level is limited to 0%, so that a negative input signal due to gain and bias settings will be read as 0%.

Note:

When H3-01 = 0, 1, set DIP switch S1-1 to the V side (voltage). When H3-01 = 2, 3, set DIP switch S1-1 to the I side (current). The default setting is the V side (voltage).

■ **H3-02: Terminal A1 Function Selection**

No. (Hex.)	Name	Description	Default (Range)
H3-02 (0434)	Terminal A1 Function Selection	V/f CL-V/f OLV CLV AOLV OLV/PM AOLV/PM CLV/PM EZOLV Sets the function for MFAI terminal A1.	0 (0 - 32)

■ **H3-03: Terminal A1 Gain Setting**

No. (Hex.)	Name	Description	Default (Range)
H3-03 (0411) RUN	Terminal A1 Gain Setting	V/f CL-V/f OLV CLV AOLV OLV/PM AOLV/PM CLV/PM EZOLV Sets the gain of the analog signal input to MFAI terminal A1.	100.0% (-999.9 - +999.9%)

This parameter sets the quantity of reference for the function set for terminal A1 as a percentage when 10 V (or 20 mA) is input.

Use this parameter and H3-04 [Terminal A1 Bias Setting] to adjust the characteristics of the analog input signal to terminal A1.

■ H3-04: Terminal A1 Bias Setting

No. (Hex.)	Name	Description	Default (Range)
H3-04 (0412) RUN	Terminal A1 Bias Setting	V/f CL-V/f OLV CLV AOLV OLV/PM AOLV/PM CLV/PM EZOLV Sets the bias of the analog signal input to MFAI terminal A1.	0.0% (-999.9 - +999.9%)

This parameter sets the bias for the function set for terminal A1 as a percentage when 0 V (4 mA or 0 mA) is input.

Use this parameter and *H3-03 [Terminal A1 Gain Setting]* to adjust the characteristics of the analog input signal to terminal A1.

■ H3-05: Terminal A3 Signal Level Select

No. (Hex.)	Name	Description	Default (Range)
H3-05 (0413)	Terminal A3 Signal Level Select	V/f CL-V/f OLV CLV AOLV OLV/PM AOLV/PM CLV/PM EZOLV Sets the input signal level for MFAI terminal A3.	0 (0 - 3)

0 : 0-10V (Lower Limit at 0)

The voltage signal is 0 Vdc to 10 Vdc. The minimum input level limit is 0%. The drive will read a negative input signal caused by gain and bias settings as 0%.

1 : -10 to +10V (Bipolar Reference)

The voltage signal is -10 Vdc to 10 Vdc. Signals of both positive and negative polarities are enabled. When the drive uses this setting as the frequency reference, a Forward Run command will run the motor in reverse and a Reverse Run command will run the motor forward. The gain and bias settings will cause the signal to be a negative number.

2 : 4 to 20 mA

The current signal is 4 mA to 20 mA. The minimum input level limit is 0%. The minimum input level is limited to 0%, so that a negative input signal due to gain and bias settings will be read as 0%.

3 : 0 to 20 mA

The current signal is 0 mA to 20 mA. The minimum input level limit is 0%. The minimum input level is limited to 0%, so that a negative input signal due to gain and bias settings will be read as 0%.

Note:

When *H3-05* = 0, 1, set DIP switch S1-3 to the V side (voltage). When *H3-05* = 2, 3, set DIP switch S1-3 to the I side (current). The default setting is the V side (voltage).

■ H3-06: Terminal A3 Function Selection

No. (Hex.)	Name	Description	Default (Range)
H3-06 (0414)	Terminal A3 Function Selection	V/f CL-V/f OLV CLV AOLV OLV/PM AOLV/PM CLV/PM EZOLV Sets the function for MFAI terminal A3.	2 (0 - 32)

Note:

When terminal A3 is the PTC input terminal:

- Set H3-06 = E [Motor Temperature (PTC input)]
- Set DIP switch S4 to the PTC side
- Set DIP switch S1-3 to the V side

■ H3-07: Terminal A3 Gain Setting

No. (Hex.)	Name	Description	Default (Range)
H3-07 (0415) RUN	Terminal A3 Gain Setting	V/f CL-V/f OLV CLV AOLV OLV/PM AOLV/PM CLV/PM EZOLV Sets the gain of the analog signal input to MFAI terminal A3.	100.0% (-999.9 - +999.9%)

When 10 V (or 20 mA) is input, this parameter sets the reference quantity for the function set for terminal A3 as a percentage.

Use this parameter and *H3-08 [Terminal A3 Bias Setting]* to adjust the characteristics of the analog input signal to terminal A3.

■ H3-08: Terminal A3 Bias Setting

No. (Hex.)	Name	Description	Default (Range)
H3-08 (0416) RUN	Terminal A3 Bias Setting	<div style="display: flex; justify-content: space-between; font-size: 0.8em; font-weight: bold;"> V/f CL-V/f OLV CLV AOLV OLV/PM AOLV/PM CLV/PM EZOLV </div> Sets the bias of the analog signal input to MFAI terminal A3.	0.0% (-999.9 - +999.9%)

When 0 V (4 mA or 0 mA) is input, this parameter sets the bias for the function set for terminal A3 as a percentage.

Use this parameter and H3-07 [Terminal A3 Gain Setting] to adjust the characteristics of the analog input signal to terminal A3.

■ H3-09: Terminal A2 Signal Level Select

No. (Hex.)	Name	Description	Default (Range)
H3-09 (0417)	Terminal A2 Signal Level Select	<div style="display: flex; justify-content: space-between; font-size: 0.8em; font-weight: bold;"> V/f CL-V/f OLV CLV AOLV OLV/PM AOLV/PM CLV/PM EZOLV </div> Sets the input signal level for MFAI terminal A2.	2 (0 - 3)

0 : 0-10V (Lower Limit at 0)

The voltage signal is 0 Vdc to 10 Vdc. The minimum input level is limited to 0%, so that a negative input signal due to gain and bias settings will be read as 0%.

1 : -10 to +10V (Bipolar Reference)

The voltage signal is -10 Vdc to 10 Vdc. Signals of both positive and negative polarities are enabled. When the drive uses this setting as the frequency reference, a Forward Run command will run the motor in reverse and a Reverse Run command will run the motor forward. The gain and bias settings will cause the signal to be a negative number.

2 : 4 to 20 mA

The current signal is 4 mA to 20 mA. The minimum input level is limited to 0%, so that a negative input signal due to gain and bias settings will be read as 0%.

3 : 0 to 20 mA

The current signal is 0 mA to 20 mA. The minimum input level is limited to 0%, so that a negative input signal due to gain and bias settings will be read as 0%.

Note:

When H3-09 = 0, 1, set DIP switch S1-2 to the V side (voltage). When H3-09 = 2, 3, set DIP switch S1-2 to the I side (current).

■ H3-10: Terminal A2 Function Selection

No. (Hex.)	Name	Description	Default (Range)
H3-10 (0418)	Terminal A2 Function Selection	<div style="display: flex; justify-content: space-between; font-size: 0.8em; font-weight: bold;"> V/f CL-V/f OLV CLV AOLV OLV/PM AOLV/PM CLV/PM EZOLV </div> Sets the function for MFAI terminal A2.	0 (0 - 32)

■ H3-11: Terminal A2 Gain Setting

No. (Hex.)	Name	Description	Default (Range)
H3-11 (0419) RUN	Terminal A2 Gain Setting	<div style="display: flex; justify-content: space-between; font-size: 0.8em; font-weight: bold;"> V/f CL-V/f OLV CLV AOLV OLV/PM AOLV/PM CLV/PM EZOLV </div> Sets the gain of the analog signal input to MFAI terminal A2.	100.0% (-999.9 - +999.9%)

When 10 V (or 20 mA) is input, this parameter sets the reference quantity for the function set for terminal A2 as a percentage.

Use this parameter and H3-12 [Terminal A2 Bias Setting] to adjust the characteristics of the analog input signal to terminal A2.

■ H3-12: Terminal A2 Bias Setting

No. (Hex.)	Name	Description	Default (Range)
H3-12 (041A) RUN	Terminal A2 Bias Setting	V/f CL-V/f OLV CLV AOLV OLV/PM AOLV/PM CLV/PM EZOLV Sets the bias of the analog signal input to MFAI terminal A2.	0.0% (-999.9 - +999.9%)

When 0 V (4 mA or 0 mA) is input, this parameter sets the bias for the function set for terminal A2 as a percentage.

Use this parameter and *H3-11 [Terminal A2 Gain Setting]* to adjust the characteristics of the analog input signal to terminal A2.

■ H3-13: Analog Input FilterTime Constant

No. (Hex.)	Name	Description	Default (Range)
H3-13 (041B)	Analog Input FilterTime Constant	V/f CL-V/f OLV CLV AOLV OLV/PM AOLV/PM CLV/PM EZOLV Sets the time constant for primary delay filters on MFAI terminals.	0.03 s (0.00 - 2.00 s)

Apply the primary delay filter to the analog input to enable an analog input signal without the use of high-frequency noise components. An analog input filter prevents irregular drive control. Drive operation becomes more stable as the programmed time becomes longer, but it also becomes less responsive to quickly changing analog signals.

■ H3-14: Analog Input Terminal Enable Sel

No. (Hex.)	Name	Description	Default (Range)
H3-14 (041C)	Analog Input Terminal Enable Sel	V/f CL-V/f OLV CLV AOLV OLV/PM AOLV/PM CLV/PM EZOLV Sets the enabled terminal or terminals when $H1-xx = C$ [<i>MFDI Function Select = Analog Terminal Enable Selection</i>] is ON.	7 (1 - 7)

Input signals do not have an effect on terminals not set as targets.

1 : Terminal A1 only

2 : Terminal A2 only

3 : Terminals A1 and A2

4 : Terminal A3 only

5 : Terminals A1 and A3

6 : Terminals A2 and A3

7 : Terminals A1, A2, and A3

Note:

- The ON/OFF operation of terminal S_x set in *Analog Terminal Input Selection* [$H1-xx = C$] has an effect on only the analog input terminal selected with *H3-14*.
- When $H1-xx \neq C$, the functions set to terminals A1 to A3 are always enabled.

■ H3-16: Terminal A1 Offset

No. (Hex.)	Name	Description	Default (Range)
H3-16 (02F0)	Terminal A1 Offset	V/f CL-V/f OLV CLV AOLV OLV/PM AOLV/PM CLV/PM EZOLV Sets the offset level for analog signals input to terminal A1. Usually it is not necessary to change this setting.	0 (-500 - +500)

Adds the offset value for the analog input value. For voltage input, this parameter will set the offset when a signal of 0 V is input. For current input, this parameter will set the offset when a signal of 4 mA [$H3-01 = 2$] or 0 mA [$H3-01 = 3$] is input.

■ H3-17: Terminal A2 Offset

No. (Hex.)	Name	Description	Default (Range)
H3-17 (02F1)	Terminal A2 Offset	V/f CL-V/f OLV CLV AOLV OLV/PM AOLV/PM CLV/PM EZOLV Sets the offset level for analog signals input to terminal A2. Usually it is not necessary to change this setting.	0 (-500 - +500)

Adds the offset value for the analog input value. For voltage input, this parameter will set the offset when a signal of 0 V is input. For current input, this parameter will set the offset when a signal of 4 mA [H3-09 = 2] or 0 mA [H3-09 = 3] is input.

■ **H3-18: Terminal A3 Offset**

No. (Hex.)	Name	Description	Default (Range)
H3-18 (02F2)	Terminal A3 Offset	V/f CL-V/f OLV CLV AOLV OLV/PM AOLV/PM CLV/PM EZOLV Sets the offset level for analog signals input to terminal A3. Usually it is not necessary to change this setting.	0 (-500 - +500)

Adds the offset value for the analog input value. For voltage input, this parameter will set the offset when a signal of 0 V is input. For current input, this parameter will set the offset when a signal of 4 mA [H3-05 = 2] or 0 mA [H3-05 = 3] is input.

■ **H3-40: Mbus Reg 15C1h Input Function**

No. (Hex.)	Name	Description	Default (Range)
H3-40 (0B5C)	Mbus Reg 15C1h Input Function	V/f CL-V/f OLV CLV AOLV OLV/PM AOLV/PM CLV/PM EZOLV Sets the MEMOBUS A11 function.	F (4 - 2F)

You can use the MFAI function from MEMOBUS/Modbus communications. Use this parameter to set the function. Sets the function for MEMOBUS/Modbus register 15C1h.

Refer to [Multi-Function Analog Input Terminal Settings on page 890](#) for the setting values.

■ **H3-41: Mbus Reg 15C2h Input Function**

No. (Hex.)	Name	Description	Default (Range)
H3-41 (0B5F)	Mbus Reg 15C2h Input Function	V/f CL-V/f OLV CLV AOLV OLV/PM AOLV/PM CLV/PM EZOLV Sets the MEMOBUS A12 function.	F (4 - 2F)

You can use the MFAI function from MEMOBUS/Modbus communications. Use this parameter to set the function. Sets the function for MEMOBUS/Modbus register 15C2h.

Refer to [Multi-Function Analog Input Terminal Settings on page 890](#) for the setting values.

■ **H3-42: Mbus Reg 15C3h Input Function**

No. (Hex.)	Name	Description	Default (Range)
H3-42 (0B62)	Mbus Reg 15C3h Input Function	V/f CL-V/f OLV CLV AOLV OLV/PM AOLV/PM CLV/PM EZOLV Sets the MEMOBUS A13 function.	F (4 - 2F)

You can use the MFAI function from MEMOBUS/Modbus communications. Use this parameter to set the function. Sets the input for the function in MEMOBUS/Modbus register 15C3.

Refer to [Multi-Function Analog Input Terminal Settings on page 890](#) for the setting values.

■ **H3-43: Mbus Reg Inputs FilterTime Const**

No. (Hex.)	Name	Description	Default (Range)
H3-43 (117F)	Mbus Reg Inputs FilterTime Const	V/f CL-V/f OLV CLV AOLV OLV/PM AOLV/PM CLV/PM EZOLV Sets the time constant to apply a primary delay filter to the MEMOBUS analog input register values.	0.00 s (0.00 - 2.00 s)

◆ **Multi-Function Analog Input Terminal Settings**

This section gives information about the functions set with H3-02, H3-06, and H3-10.

■ **0: Frequency Reference**

Setting Value	Function	Description
0	Frequency Reference	V/f CL-V/f OLV CLV AOLV OLV/PM AOLV/PM CLV/PM EZOLV The input value from the MFAI terminal set with this function becomes the master frequency reference.

- You can copy the configuration to more than one of the analog input terminals A1 through A3. When you set more than one analog input terminal with the master frequency reference, the sum value becomes the frequency bias.
- If you use this function to set the analog input value as the master frequency reference, set $b1-01 = 1$ [*Frequency Reference Selection 1 = Analog Input*]. This setting value is the default value for terminals A1 and A2.
- The frequency reference is the sum of the input values for terminals A1 and A2 when they are used at the same time. For example, when a 20% bias is input to terminal A2 while a frequency reference of 50% is input from terminal A1, the calculated frequency reference will be 70% of the maximum output frequency.

1: Frequency Gain

Setting Value	Function	Description
1	Frequency Gain	<div style="display: flex; justify-content: space-between; align-items: center;"> V/f CL-V/f OLV CLV AOLV OLV/PM AOLV/PM CLV/PM EZOLV </div> <p>The drive multiplies the analog frequency reference with the input value from the MFAI set with this function.</p>

Example: When you set frequency gain for terminal A2

- $H3-10 = 1$ [*Terminal A2 Function Selection = Frequency Gain*]
- A 50% frequency gain is input to terminal A2
- A frequency reference of 80% is input from terminal A1

The calculated frequency reference is 40% of the maximum output frequency.

2: Auxiliary Frequency Reference 1

Setting Value	Function	Description
2	Auxiliary Frequency Reference 1	<div style="display: flex; justify-content: space-between; align-items: center;"> V/f CL-V/f OLV CLV AOLV OLV/PM AOLV/PM CLV/PM EZOLV </div> <p>Sets Reference 2 through multi-step speed reference to enable the command reference (Auxiliary Frequency Reference 1) from the analog input terminal set here. This value is a percentage where the Maximum Output Frequency setting is a setting value of 100%.</p>

3: Auxiliary Frequency Reference 2

Setting Value	Function	Description
3	Auxiliary Frequency Reference 2	<div style="display: flex; justify-content: space-between; align-items: center;"> V/f CL-V/f OLV CLV AOLV OLV/PM AOLV/PM CLV/PM EZOLV </div> <p>Sets Reference 3 through multi-step speed reference to enable the command reference (Auxiliary Frequency Reference 2) from the analog input terminal set here. This value is a percentage where the Maximum Output Frequency setting is a setting value of 100%.</p>

4: Output Voltage Bias

Setting Value	Function	Description
4	Output Voltage Bias	<div style="display: flex; justify-content: space-between; align-items: center;"> V/f CL-V/f OLV CLV AOLV OLV/PM AOLV/PM CLV/PM EZOLV </div> <p>Set this parameter to input a bias signal and amplify the output voltage.</p>

The gain (%) for the MFAI terminals A1, A2, and A3 is 100% of the voltage class standard, which is 200 V for 200 V class drives and 400 V for 400 V class drives. The bias (%) for MFAI terminals A1, A2, and A3 is 100% of the voltage configured for $E1-05$ [*Maximum Output Voltage*].

Note:

The gain for each terminal A1, A2, and A3 is configured independently with $H3-03$ [*Terminal A1 Gain Setting*], $H3-11$ [*Terminal A2 Gain Setting*], and $H3-07$ [*Terminal A3 Gain Setting*]. The bias for each terminal A1, A2, and A3 is configured independently with $H3-04$ [*Terminal A1 Bias Setting*], $H3-12$ [*Terminal A2 Bias Setting*], and $H3-08$ [*Terminal A3 Bias Setting*].

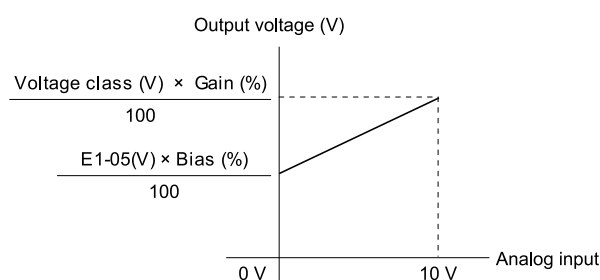

Figure 12.107 Output Voltage Bias through Analog Input

5: Accel/Decel Time Gain

Setting Value	Function	Description
5	Accel/Decel Time Gain	<div style="display: flex; justify-content: space-between; border-bottom: 1px solid black; padding-bottom: 2px;"> V/f CL-V/f OLV CLV AOLV OLV/PM AOLV/PM CLV/PM EZOLV </div> Enters a signal to adjust the gain used for <i>C1-01</i> to <i>C1-08</i> [Acceleration/Deceleration Times 1 to 4] and <i>C1-09</i> [Fast Stop Time] when the full scale analog signal (10 V or 20 mA) is 100%.

When you enable *C1-01* [Acceleration Time 1], the acceleration time is:

$$\text{Acceleration Time 1} = \text{Setting value of } C1-01 \times \text{acceleration and deceleration time gain} / 100$$

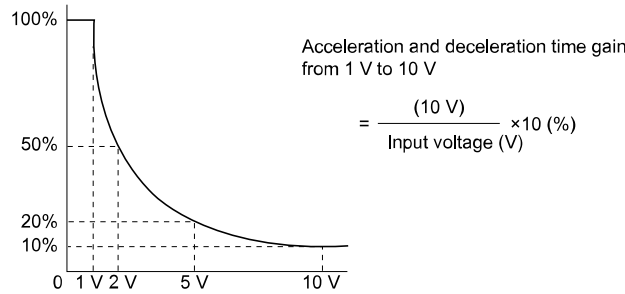

Figure 12.108 Acceleration/Deceleration Time Gain through Analog Input

6: DC Injection Braking Current

Setting Value	Function	Description
6	DC Injection Braking Current	<div style="display: flex; justify-content: space-between; border-bottom: 1px solid black; padding-bottom: 2px;"> V/f CL-V/f OLV CLV AOLV OLV/PM AOLV/PM CLV/PM EZOLV </div> Enters a signal to adjust the current level used for DC Injection Braking when the drive rated output current is 100%.

Note:

When you set this function, it will disable the setting value of *b2-02* [DC Injection Braking Current].

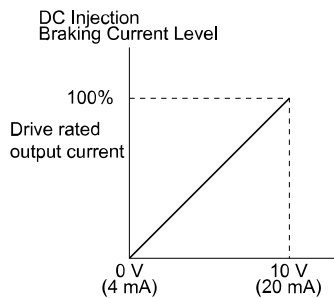

Figure 12.109 DC Injection Braking Current through Analog Input

7: Torque Detection Level

Setting Value	Function	Description
7	Torque Detection Level	<div style="display: flex; justify-content: space-between; border-bottom: 1px solid black; padding-bottom: 2px;"> V/f CL-V/f OLV CLV AOLV OLV/PM AOLV/PM CLV/PM EZOLV </div> Enters a signal to adjust the overtorque/undertorque detection level.

When *A1-02* = 0, 1, 5 [Control Method Selection = *V/f*, *CL-V/f*, *OLV/PM*], the drive rated current is 100%. When *A1-02* = 2, 3, 4, 6, 7, 8 [*OLV*, *CLV*, *AOLV*, *AOLV/PM*, *CLV/PM*, *EZOLV*], the motor rated torque is 100%.

Note:

Use this function with *L6-01* [Torque Detection Selection 1]. This parameter functions as an alternative to *L6-02* [Torque Detection Level 1].

8: Stall Prevent Level During Run

Setting Value	Function	Description
8	Stall Prevent Level During Run	<div style="display: flex; justify-content: space-between; border-bottom: 1px solid black; padding-bottom: 2px;"> V/f CL-V/f OLV CLV AOLV OLV/PM AOLV/PM CLV/PM EZOLV </div> Enters a signal to adjust the stall prevention level during run if the drive rated current is 100%.

Note:

The Stall Prevent Level During Run is based on the smaller of these two values:

- Analog input value of MFAI terminal
- *L3-06* [Stall Prevent Level during Run]

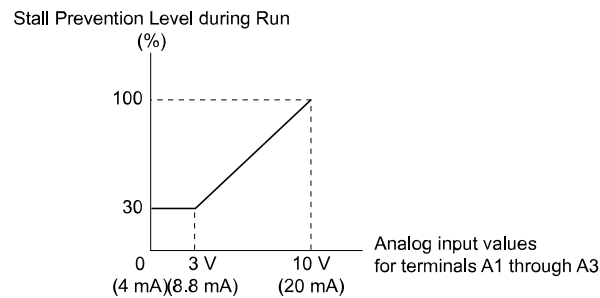

Figure 12.110 Stall Prevention Level during Run with Analog Input

■ 9: Output Frequency Lower Limit

Setting Value	Function	Description
9	Output Frequency Lower Limit	V/f CL-V/f OLV CLV AOLV OLV/PM AOLV/PM CLV/PM EZOLV Enters a signal to adjust the output frequency lower limit level as a percentage of the maximum output frequency.

■ B: PID Feedback

Setting Value	Function	Description
B	PID Feedback	V/f CL-V/f OLV CLV AOLV OLV/PM AOLV/PM CLV/PM EZOLV Enter the PID feedback value as a percentage of the maximum output frequency.

When you use this function, set $b5-01 = 1$ to 8 [PID Mode Setting = Enabled].

■ C: PID Setpoint

Setting Value	Function	Description
C	PID Setpoint	V/f CL-V/f OLV CLV AOLV OLV/PM AOLV/PM CLV/PM EZOLV Enters the PID setpoint as a percentage of the maximum output frequency.

When you use this function, set $b5-01 = 1$ to 8 [PID Mode Setting = Enabled].

Note:

Configuring this function disables the frequency reference set with $b1-01$ [Frequency Reference Selection 1].

■ D: Frequency Bias

Setting Value	Function	Description
D	Frequency Bias	V/f CL-V/f OLV CLV AOLV OLV/PM AOLV/PM CLV/PM EZOLV Enters the bias value added to the frequency reference as a percentage of the maximum output frequency.

The drive adds the input value from the MFAI terminal set with this function to the frequency reference as the bias value.

Note:

When you select $d1-01$ to $d1-16$ or $d1-17$ [Reference 1 to 16 or JOG Frequency Reference] as the frequency reference, it will disable this function.

■ E: Motor Temperature (PTC Input)

Setting Value	Function	Description
E	Motor Temperature (PTC Input)	V/f CL-V/f OLV CLV AOLV OLV/PM AOLV/PM CLV/PM EZOLV Uses the motor Positive Temperature Coefficient (PTC) thermistor to prevent heat damage to the motor as a percentage of the current value when the 10 V analog signal is input.

- You can use the Positive Temperature Coefficient (PTC) thermistor as an auxiliary or alternative detection function for $oL1$ [Motor Overload] problems to help prevent heat damage to motors. If the PTC input signal is more than the overload alarm level, $oH3$ [Motor Overheat (PTC Input)] will flash on the keypad.
- When the drive detects $oH3$, the motor stops with the setting in $L1-03$. When the drive detects $oH4$, the motor stops with the setting in $L1-04$. When the drive incorrectly detects motor overheating problems, set $L1-05$.

■ F: Not Used

Setting Value	Function	Description
F	Not Used	<div style="display: flex; justify-content: space-between; font-size: small;"> V/f CL-V/f OLV CLV AOLV OLV/IPM AOLV/IPM CLV/IPM EZOLV </div> <p>Use this setting for unused terminals or to use terminals in through mode.</p>

When you set a terminal that is not in use to F, you can use the signal input to the terminal as PLC analog signal input through MEMOBUS/Modbus communications or the communication option. This input signal does not have an effect on drive operation. This functions the same as setting 1F (Through Mode).

■ 10: Forward Torque Limit

Setting Value	Function	Description
10	Forward Torque Limit	<div style="display: flex; justify-content: space-between; font-size: small;"> V/f CL-V/f OLV CLV AOLV OLV/IPM AOLV/IPM CLV/IPM EZOLV </div> <p>Enters the forward torque limit if the motor rated torque is 100%.</p>

WARNING! Sudden Movement Hazard. Set correct torque limits for applications, for example elevator applications. If you set torque limits incorrectly, motor torque that is not sufficient can cause damage to equipment and cause serious injury or death.

Torque Limit Configuration Method

Use one of these methods to set torque limits:

- Individually set the four torque limit quadrants using L7-01 to L7-04 [Torque Limit].
- Use MFAI to individually set the four torque limit quadrants. Set H3-02, H3-06, H3-10 = 10, 11, 12 [MFAI Function Select = Forward/Reverse/Regenerative Torque Limit].
- Use MFAI to set all four torque limit quadrants together. Set H3-02, H3-06, H3-10 = 15 [General Torque Limit].
- Use a communication option to set all four torque limit quadrants together.

Figure 12.111 shows the configuration method for each quadrant.

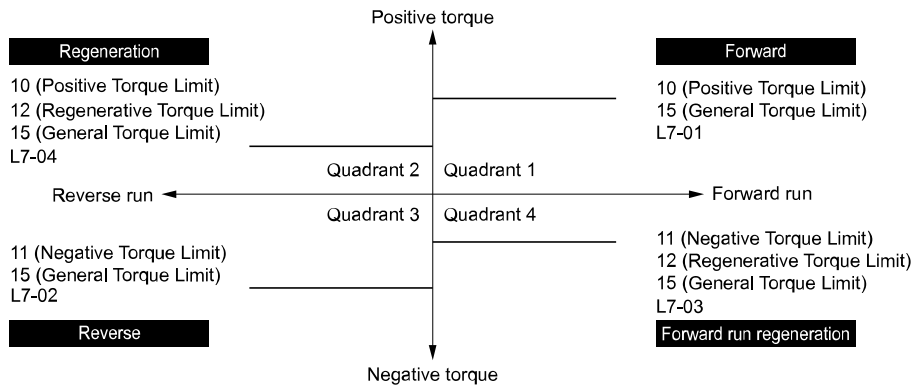

Figure 12.111 Torque Limits and Analog Input Setting Parameters

Note:

- When L7-01 to L7-04 and analog inputs or communication option torque limits set torque limits for the same quadrant, the lower value is enabled. In this example of parameter settings, the torque limit for quadrant 1 is 130% and the torque limit for quadrants 2, 3, and 4 is 150%. Settings: L7-01 = 130%, L7-02 to L7-04 = 200%, and MFAI torque limit = 150%
- The drive output current limits maximum output torque. The torque limit is 150% of the rated output current for HD and to 120% of the rated output current for ND. The actual output torque is not more than the limits of the drive rated output current when you set the torque limit to a high value.

If you use drives in applications where the vertical axis can fall, make sure that you know these items:

- Correctly configure drives and motors.
- Correctly set parameters.
- You can change parameter values after you do Auto-Tuning.
- Use a system that will not let the vertical axis fall if the drive fails.

Figure 12.112 shows the relation between torque limits from parameters and torque limits from analog input.

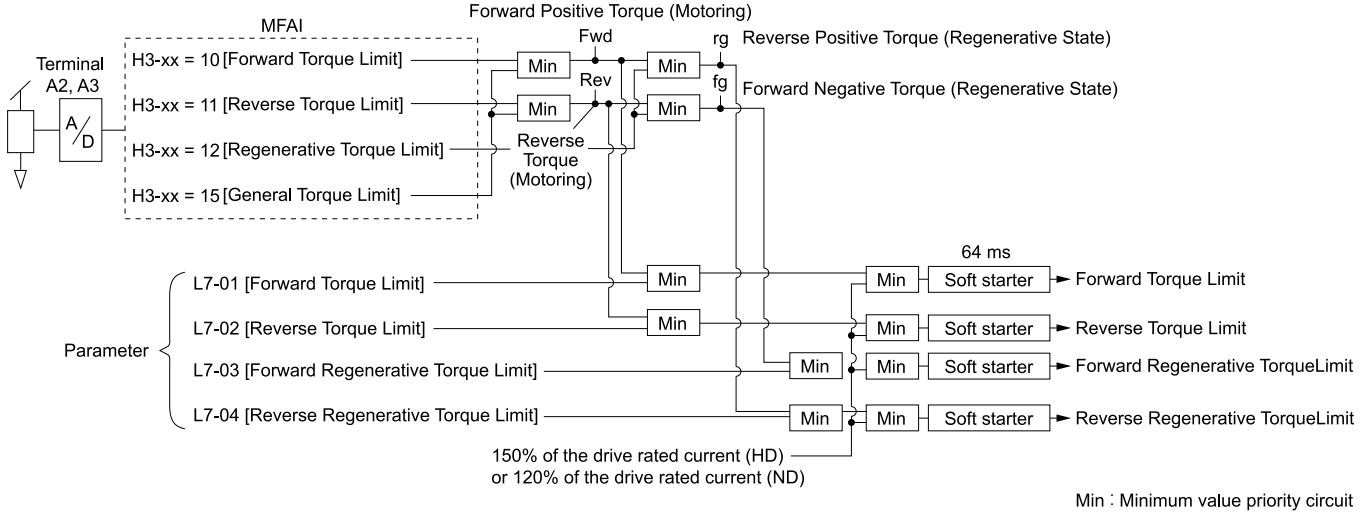

Figure 12.112 Torque Limits from Parameters and Analog Inputs

11: Reverse Torque Limit

Setting Value	Function	Description
11	Reverse Torque Limit	V/f CL-V/f OLV CLV AOLV OLV/PM AOLV/PM CLV/PM EZOLV Enters the load torque limit if the motor rated torque is 100%.

Note:

When you use L7-01 to L7-04 and analog inputs to set torque limits for the same quadrant, it will enable the lower torque limit.

12: Regenerative Torque Limit

Setting Value	Function	Description
12	Regenerative Torque Limit	V/f CL-V/f OLV CLV AOLV OLV/PM AOLV/PM CLV/PM EZOLV Enters the regenerative torque limit if the motor rated torque is 100%.

Note:

When you use L7-01 to L7-04 and analog inputs to set torque limits for the same quadrant, it will enable the lower torque limit.

13: Torque Reference / Torque Limit

Setting Value	Function	Description
13	Torque Reference / Torque Limit	V/f CL-V/f OLV CLV AOLV OLV/PM AOLV/PM CLV/PM EZOLV Enters the torque reference if the motor rated torque is 100%. This setting is the torque limit for speed control.

Note:

When you use L7-01 to L7-04 and analog inputs to set torque limits for the same quadrant, it will enable the lower torque limit.

14: Torque Compensation

Setting Value	Function	Description
14	Torque Compensation	V/f CL-V/f OLV CLV AOLV OLV/PM AOLV/PM CLV/PM EZOLV Enters the torque compensation value if the motor rated torque is 100%.

15: General Torque Limit

Setting Value	Function	Description
15	General Torque Limit	V/f CL-V/f OLV CLV AOLV OLV/PM AOLV/PM CLV/PM EZOLV Enters the torque limit that is the same for all quadrants for forward, reverse, and regenerative operation if the motor rated torque is 100%.

16: Differential PID Feedback

Setting Value	Function	Description
16	Differential PID Feedback	V/f CL-V/f OLV CLV AOLV OLV/PM AOLV/PM CLV/PM EZOLV Enters the PID differential feedback value if the full scale analog signal (10 V or 20 mA) is 100%.

Parameter Details

The drive uses the deviation between the PID feedback and the differential feedback value signals to calculate the PID input.

■ **1F: Not Used**

Setting Value	Function	Description
1F	Not Used	<div style="display: flex; justify-content: space-between; gap: 5px;"> V/f CL-V/f OLV CLV AOLV OLV/PM AOLV/PM CLV/PM EZOLV </div> Use this setting for unused terminals or to use terminals in through mode.

When you set a terminal that you do not use to 1F, you can use the signal that is input to that terminal as the PLC analog signal input from MEMOBUS/Modbus communications or the communication option. This input signal does not have an effect on drive operation. This signal functions the same as F (Through Mode).

■ **30: DWEZ Analog Input 1**

Setting Value	Function	Description
30	DWEZ Analog Input 1	<div style="display: flex; justify-content: space-between; gap: 5px;"> V/f CL-V/f OLV CLV AOLV OLV/PM AOLV/PM CLV/PM EZOLV </div> Use with DriveWorksEZ. Refer to the DriveWorksEZ online manual for more information.

■ **31: DWEZ Analog Input 2**

Setting Value	Function	Description
31	DWEZ Analog Input 2	<div style="display: flex; justify-content: space-between; gap: 5px;"> V/f CL-V/f OLV CLV AOLV OLV/PM AOLV/PM CLV/PM EZOLV </div> Use with DriveWorksEZ. Refer to the DriveWorksEZ online manual for more information.

■ **32: DWEZ Analog Input 3**

Setting Value	Function	Description
32	DWEZ Analog Input 3	<div style="display: flex; justify-content: space-between; gap: 5px;"> V/f CL-V/f OLV CLV AOLV OLV/PM AOLV/PM CLV/PM EZOLV </div> Use with DriveWorksEZ. Refer to the DriveWorksEZ online manual for more information.

◆ **H4: Analog Outputs**

H4 parameters set the drive analog monitors. These parameters select monitor parameters, adjust gain and bias, and select output signal levels.

■ **Calibrate Meters Connected to MFAO Terminals FM and AM**

To calibrate the meters connected to terminals FM and AM, use these parameters:

- H4-02 [Terminal FM Analog Output Gain]
- H4-03 [Terminal FM Analog Output Bias]
- H4-05 [Terminal AM Analog Output Gain]
- H4-06 [Terminal AM Analog Output Bias]

Set these parameters where the output voltage of 10 V and output current of 20 mA are 100% of the signal level. Use jumper switch S5 and H4-07 [Terminal FM Signal Level Select] or H4-08 [Terminal AM Signal Level Select] to select the voltage output and current output.

No.	Name	Range	Default
H4-02	Terminal FM Analog Output Gain	-999.9 - +999.9%	100.0%
H4-03	Terminal FM Analog Output Bias	-999.9 - +999.9%	0.0%
H4-05	Terminal AM Analog Output Gain	-999.9 - +999.9%	50.0%
H4-06	Terminal AM Analog Output Bias	-999.9 - +999.9%	0.0%
H4-07	Terminal FM Signal Level Select	0: 0 to 10 Vdc 1: -10 to +10 Vdc 2: 4 to 20 mA	0
H4-08	Terminal AM Signal Level Select	0: 0 to 10 Vdc 1: -10 to +10 Vdc 2: 4 to 20 mA	0

Figure 12.113 and Figure 12.114 show the gain and bias.

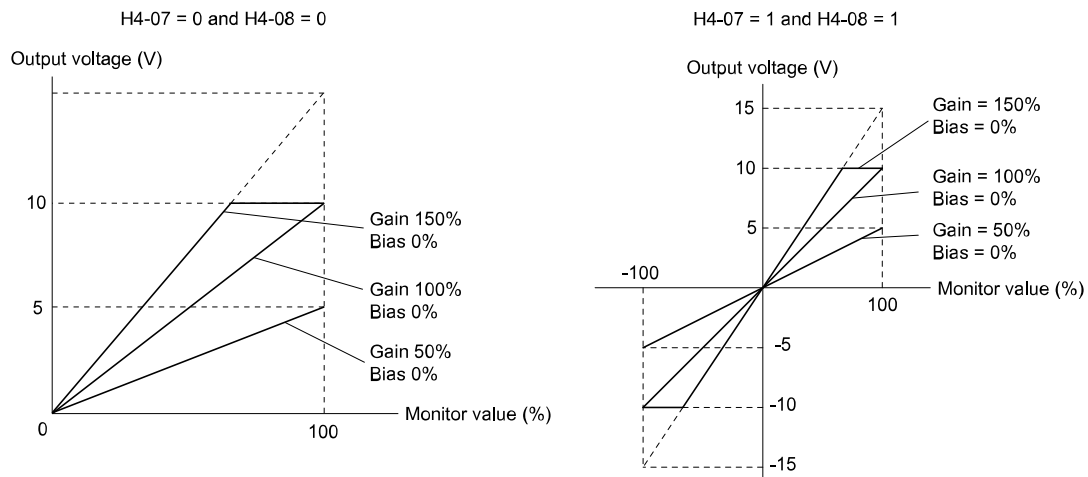

Figure 12.113 Analog Output Gain/Bias Configuration Example 1

For example, when the parameter value set to analog output is 0, and a 3 V signal is output to terminal FM, *H4-03 [Terminal FM Analog Output Bias]* is set to 30%.

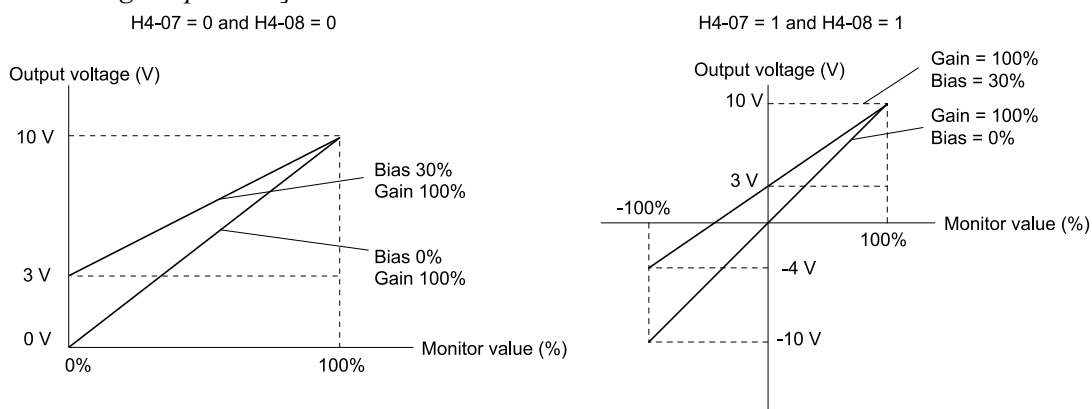

Figure 12.114 Analog Output Gain/Bias Configuration Example 2

Calibrate Terminal FM

Stop the drive to calibrate meters. Use this procedure to calibrate:

1. Show *H4-02 [Terminal FM Analog Output Gain]* on the keypad. Terminal FM outputs the analog signal when the monitor item that you set in *H4-01 [Terminal FM Analog Output Select]* is 100%.
2. Adjust *H4-02* while referencing the meter scale connected to terminal FM.
3. Show *H4-03 [Terminal FM Analog Output Bias]* on the keypad. Terminal FM outputs the analog signal when the monitor item that you set in *H4-01* is 0%.
4. Adjust *H4-03* while referencing the meter scale connected to terminal FM.

Calibrate Terminal AM

Stop the drive to calibrate meters. Use this procedure to calibrate:

1. Show *H4-05 [Terminal AM Analog Output Gain]* on the keypad. Terminal AM outputs the analog signal when the monitor item that you set in *H4-04 [Terminal AM Analog Output Select]* is 100%.
2. Adjust *H4-05* while referencing the meter scale connected to terminal AM.
3. Show *H4-06 [Terminal AM Analog Output Bias]* on the keypad. Terminal AM outputs the analog signal when the monitor item that you set in *H4-04* is 0%.
4. Adjust *H4-06* while referencing the meter scale connected to terminal AM.

■ H4-01: Terminal FM Analog Output Select

No. (Hex.)	Name	Description	Default (Range)
H4-01 (041D)	Terminal FM Analog Output Select	V/f CL-V/f OLV CLV AOLV OLV/PM AOLV/PM CLV/PM EZOLV Sets the monitoring number (Ux-xx) to be output from MFAO terminal FM.	102 (000 - 9999)

Parameter Details

Note:

- Set the *x-xx* part of the *Ux-xx* [Monitor]. For example, set *H4-01 = 102* to monitor *U1-02* [Output Frequency]. When the *x* part of *Ux* is a letter, replace the letter (hexadecimal number) with a decimal number. For example, set *H4-01 = 1301* to monitor *Ud-01*.
- You cannot use all of the monitors in all of the control methods.
- When you use the terminal in through mode, set this parameter to *000* or *031*. You can set the terminal FM output level from the PLC through MEMOBUS/Modbus communications or the communication option.

■ **H4-02: Terminal FM Analog Output Gain**

No. (Hex.)	Name	Description	Default (Range)
H4-02 (041E) RUN	Terminal FM Analog Output Gain	V/f CL-V/f OLV CLV AOLV OLV/PM AOLV/PM CLV/PM EZOLV Sets the gain of the monitor signal that is sent from MFAO terminal FM.	100.0% (-999.9 - +999.9%)

The analog signal output from the FM terminal is a maximum of ±10 V (or 20 mA). Select the signal level with *H4-07* [Terminal FM Signal Level Select].

■ **H4-03: Terminal FM Analog Output Bias**

No. (Hex.)	Name	Description	Default (Range)
H4-03 (041F) RUN	Terminal FM Analog Output Bias	V/f CL-V/f OLV CLV AOLV OLV/PM AOLV/PM CLV/PM EZOLV Sets the bias of the monitor signal that is sent from MFAO terminal FM.	0.0% (-999.9 - +999.9%)

The analog signal output from the FM terminal is a maximum of ±10 V (or 20 mA). Select the signal level with *H4-07* [Terminal FM Signal Level Select].

■ **H4-04: Terminal AM Analog Output Select**

No. (Hex.)	Name	Description	Default (Range)
H4-04 (0420)	Terminal AM Analog Output Select	V/f CL-V/f OLV CLV AOLV OLV/PM AOLV/PM CLV/PM EZOLV Sets the monitoring number (<i>Ux-xx</i>) to be output from MFAO terminal AM.	103 (000 - 9999)

Note:

- Set the *x-xx* part of the *Ux-xx* [Monitor]. For example, set *H4-04 = 103* to monitor *U1-03* [Output Current]. When the *x* part of *Ux* is a letter, replace the letter (hexadecimal number) with a decimal number. For example, set *H4-04 = 1301* to monitor *Ud-01*.
- You cannot use all of the monitors in all of the control methods.
- When you use the terminal in through mode, set this parameter to *000* or *031*. You can set the terminal AM output level from the PLC through MEMOBUS/Modbus communications or the communication option.

■ **H4-05: Terminal AM Analog Output Gain**

No. (Hex.)	Name	Description	Default (Range)
H4-05 (0421) RUN	Terminal AM Analog Output Gain	V/f CL-V/f OLV CLV AOLV OLV/PM AOLV/PM CLV/PM EZOLV Sets the gain of the monitor signal that is sent from MFAO terminal AM.	50.0% (-999.9 - +999.9%)

The analog signal output from the AM terminal is a maximum of ±10 V (or 20 mA). Select the signal level with *H4-08* [Terminal AM Signal Level Select].

Example settings:

When the output current of a monitoring item is 100% (drive rated current) in these examples, the voltage of AM terminal outputs at 5 V (50% of 10 V). Subsequently, the output current at the time the AM terminal outputs a maximum voltage of 10 V will be 200% of the drive rated current.

- *H4-04 = 103* [Terminal AM Analog Output Select = Output Current]
- *H4-05 = 50.0%*
- *H4-06 = 0.0%* [Terminal AM Analog Output Bias = 0.0%]
- *H4-08 = 0* [0 to 10 V]

■ H4-06: Terminal AM Analog Output Bias

No. (Hex.)	Name	Description	Default (Range)
H4-06 (0422) RUN	Terminal AM Analog Output Bias	V/f CL-V/f OLV CLV AOLV OLV/PM AOLV/PM CLV/PM EZOLV Sets the bias of the monitor signal that is sent from MFAO terminal AM.	0.0% (-999.9 - +999.9%)

The analog signal output from the AM terminal is a maximum of ± 10 V (or 20 mA). Select the signal level with *H4-08 [Terminal AM Signal Level Select]*.

■ H4-07: Terminal FM Signal Level Select

No. (Hex.)	Name	Description	Default (Range)
H4-07 (0423)	Terminal FM Signal Level Select	V/f CL-V/f OLV CLV AOLV OLV/PM AOLV/PM CLV/PM EZOLV Sets the MFAO terminal FM output signal level.	0 (0 - 2)

Note:

Set jumper S5 on the control circuit terminal block accordingly when changing these parameters.

0 : 0 to 10 Vdc

1 : -10 to +10 Vdc

2 : 4 to 20 mA

■ H4-08: Terminal AM Signal Level Select

No. (Hex.)	Name	Description	Default (Range)
H4-08 (0424)	Terminal AM Signal Level Select	V/f CL-V/f OLV CLV AOLV OLV/PM AOLV/PM CLV/PM EZOLV Sets the MFAO terminal AM output signal level.	0 (0 - 2)

Note:

Set jumper S5 on the control circuit terminal block accordingly when changing these parameters.

0 : 0 to 10 Vdc

1 : -10 to +10 Vdc

2 : 4 to 20 mA

■ H4-20: Analog Power Monitor 100% Level

No. (Hex.)	Name	Description	Default (Range)
H4-20 (0B53)	Analog Power Monitor 100% Level	V/f CL-V/f OLV CLV AOLV OLV/PM AOLV/PM CLV/PM EZOLV Sets the level at 10 V when <i>U1-08 [Output Power]</i> is set for analog output.	0.00 kW (0.00 - 1000.0 kW)

Note:

• When *H4-20* = 0.00 kW, the output power monitor 10 V level = motor rated power. The setting changes when the *A1-02 [Control Method Selection]* value changes:

– *A1-02* = 0, 1 [*V/f*, *CL-V/f*]: *E2-11 [Motor Rated Power]*

– *A1-02* = 2, 3, 4 [*OLV*, *CLV*, *AOLV*]: *E2-11 [Motor Rated Power]*

– *A1-02* = 5, 6, 7 [*OLV/PM*, *AOLV/PM*, *CLV/PM*]: *E5-02 [PM Motor Rated Power]*

– *A1-02* = 8 [*EZOLV*]: *E9-07 [Motor Rated Power]*

• On drive models 2xxx, and 4002 to 4675, the setting unit is 0.01 kW. The setting range is 0.00 kW to 650.00 kW. On drive models 4810 to 4H12, the setting unit is 0.1 kW. The setting range is 0.0 kW to 1000.0 kW.

◆ H5: Memobus/Modbus Communication

H5 parameters configure the drive to use MEMOBUS/Modbus communications.

You can use the MEMOBUS/Modbus protocol over the RS-485 port (terminals D+ and D-) in the drive to use serial communication with programmable controllers (PLC).

■ H5-01: Drive Node Address

No. (Hex.)	Name	Description	Default (Range)
H5-01 (0425)	Drive Node Address	V/f CL-V/f OLV CLV AOLV OLV/PM AOLV/PM CLV/PM EZOLV Sets the communication slave address for drives.	1FH (0 - FFH)

Note:

- Re-energize the drive or set $H5-20 = 1$ [*Communication Parameters Reload = Reload Now*] after you change the parameter setting.
- Setting 0 will not let the drive respond to MEMOBUS/Modbus communications.

To enable the drive to communicate with the controller (master) over MEMOBUS/Modbus communications, you must set the drive with a slave address. Set $H5-01 \neq 0$.

Set a node address that is different from the master and other slave devices.

■ H5-02: Communication Speed Selection

No. (Hex.)	Name	Description	Default (Range)
H5-02 (0426)	Communication Speed Selection	V/f CL-V/f OLV CLV AOLV OLV/PM AOLV/PM CLV/PM EZOLV Sets the communications speed for MEMOBUS/Modbus communications.	3 (0 - 8)

Note:

Re-energize the drive or set $H5-20 = 1$ [*Communication Parameters Reload = Reload Now*] after you change the parameter setting.

- 0 : 1200 bps**
- 1 : 2400 bps**
- 2 : 4800 bps**
- 3 : 9600 bps**
- 4 : 19.2 kbps**
- 5 : 38.4 kbps**
- 6 : 57.6 kbps**
- 7 : 76.8 kbps**
- 8 : 115.2 kbps**

■ H5-03: Communication Parity Selection

No. (Hex.)	Name	Description	Default (Range)
H5-03 (0427)	Communication Parity Selection	V/f CL-V/f OLV CLV AOLV OLV/PM AOLV/PM CLV/PM EZOLV Sets the communications parity used for MEMOBUS/Modbus communications.	0 (0 - 2)

Note:

Re-energize the drive or set $H5-20 = 1$ [*Communication Parameters Reload = Reload Now*] after you change the parameter setting.

- 0 : No parity**
- 1 : Even parity**
- 2 : Odd parity**

■ H5-04: Communication Error Stop Method

No. (Hex.)	Name	Description	Default (Range)
H5-04 (0428)	Communication Error Stop Method	V/f CL-V/f OLV CLV AOLV OLV/PM AOLV/PM CLV/PM EZOLV Sets the motor Stopping Method when the drive detects <i>CE</i> [<i>Modbus Communication Error</i>] issues.	3 (0 - 3)

0 : Ramp to Stop

The drive ramps the motor to stop in the deceleration time. Fault relay output terminal MA-MC turns ON, and MB-MC turns OFF.

1 : Coast to Stop

The output turns off and the motor coasts to stop. Fault relay output terminal MA-MC turns ON, and MB-MC turns OFF.

2 : Fast Stop (Use C1-09)

The drive stops the motor in the deceleration time set in *C1-09 [Fast Stop Time]*. Fault relay output terminal MA-MC turns ON, and MB-MC turns OFF.

3 : Alarm Only

The keypad shows *CE* and the drive continues operation. The output terminal set for *Alarm [H2-01 to H2-03 = 10]* activates.

■ H5-05: Comm Fault Detection Selection

No. (Hex.)	Name	Description	Default (Range)
H5-05 (0429)	Comm Fault Detection Selection	V/f CL-V/f OLV CLV AOLV OLV/PM AOLV/PM CLV/PM EZOLV Sets the function that detects <i>CE [Modbus Communication Error]</i> issues during MEMOBUS/Modbus communications.	1 (0, 1)

If the drive does not receive data from the master during the time set in *H5-09 [CE Detection Time]*, it will detect a *CE* error.

0 : Disabled

Does not detect *CE*. The drive continues operation.

1 : Enabled

Detects *CE*. If the drive detects *CE*, it will operate as specified by the setting of *H5-04 [Communication Error Stop Method]*.

■ H5-06: Drive Transmit Wait Time

No. (Hex.)	Name	Description	Default (Range)
H5-06 (042A)	Drive Transmit Wait Time	V/f CL-V/f OLV CLV AOLV OLV/PM AOLV/PM CLV/PM EZOLV Sets the time to wait to send a response message after the drive receives a command message from the master.	5 ms (0 - 65 ms)

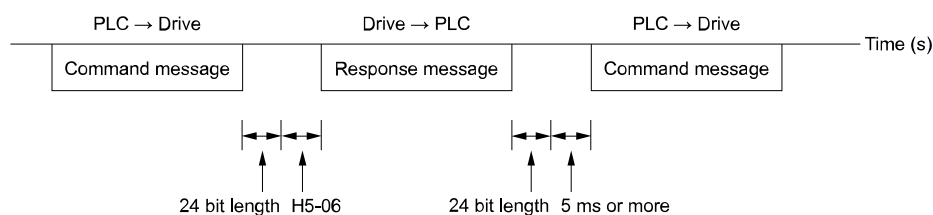

Figure 12.115 Drive Transmit Wait Time

■ H5-09: CE Detection Time

No. (Hex.)	Name	Description	Default (Range)
H5-09 (0435)	CE Detection Time	V/f CL-V/f OLV CLV AOLV OLV/PM AOLV/PM CLV/PM EZOLV Sets the detection time for <i>CE [Modbus Communication Error]</i> issues when communication stops.	2.0 s (0.0 - 10.0 s)

■ H5-10: Modbus Register 0025H Unit Sel

No. (Hex.)	Name	Description	Default (Range)
H5-10 (0436)	Modbus Register 0025H Unit Sel	V/f CL-V/f OLV CLV AOLV OLV/PM AOLV/PM CLV/PM EZOLV Sets the unit of measure used for the MEMOBUS/Modbus communications monitor register 0025H (output voltage reference monitor).	0 (0, 1)

0 : 0.1 V units

1 : 1 V units

■ H5-11: Comm ENTER Command Mode

No. (Hex.)	Name	Description	Default (Range)
H5-11 (043C)	Comm ENTER Command Mode	V/f CL-V/f OLV CLV AOLV OLV/PM AOLV/PM CLV/PM EZOLV Sets the function to make the Enter command necessary to change parameters through MEMOBUS/Modbus communications.	0 (0, 1)

0 : ENTER Command Required

You must use the Enter command to enable changes to parameters. Make all parameter changes then input the Enter command.

1 : ENTER Command Not Required

It is not necessary to input the Enter command to change parameters.

■ H5-12: Run Command Method Selection

No. (Hex.)	Name	Description	Default (Range)
H5-12 (043D)	Run Command Method Selection	<div style="display: flex; justify-content: space-between; align-items: center;"> <input type="checkbox"/> V/f <input type="checkbox"/> CL-V/f <input type="checkbox"/> OLV <input type="checkbox"/> CLV <input type="checkbox"/> AOLV <input type="checkbox"/> OLV/PM <input type="checkbox"/> AOLV/PM <input type="checkbox"/> CLV/PM <input type="checkbox"/> EZOLV </div> <p>Sets the input method for the Run command when $b1-02 = 2$ [Run Command Selection 1 = Memobus/Modbus Communications] or $b1-16 = 2$ [Run Command Selection 2 = Memobus/Modbus Communications].</p>	0 (0, 1)

0 : FWD/Stop, REV/Stop

The drive uses bit 0 in command data 0001H of the MEMOBUS register in the motor forward Run command (bit 0 = 1) and the stop command (bit 0 = 0). The drive uses bit 1 in the motor reverse Run command (bit 1 = 1) and the stop command (bit 1 = 0).

1 : Run/Stop, FWD/REV

The drive uses bit 0 in command data 0001H of the MEMOBUS register in the motor Run command (bit 0 = 1) and the stop command (bit 0 = 0). The drive uses bit 1 in the direction of motor rotation command (Forward run (bit1 = 0) or Reverse run (bit 1 = 1)).

■ H5-17: ENTER command response @CPU BUSY

No. (Hex.)	Name	Description	Default (Range)
H5-17 (11A1) Expert	ENTER command response @CPU BUSY	<div style="display: flex; justify-content: space-between; align-items: center;"> <input type="checkbox"/> V/f <input type="checkbox"/> CL-V/f <input type="checkbox"/> OLV <input type="checkbox"/> CLV <input type="checkbox"/> AOLV <input type="checkbox"/> OLV/PM <input type="checkbox"/> AOLV/PM <input type="checkbox"/> CLV/PM <input type="checkbox"/> EZOLV </div> <p>Sets operation when the EEPROM write command is sent without EEPROM write available. Usually it is not necessary to change this setting.</p>	0 (0, 1)

0 : Ignore Command(No ROM/RAM Write)**1 : Write to RAM Only****■ H5-18: Motor Speed Filter over Comms**

No. (Hex.)	Name	Description	Default (Range)
H5-18 (11A2)	Motor Speed Filter over Comms	<div style="display: flex; justify-content: space-between; align-items: center;"> <input type="checkbox"/> V/f <input type="checkbox"/> CL-V/f <input type="checkbox"/> OLV <input type="checkbox"/> CLV <input type="checkbox"/> AOLV <input type="checkbox"/> OLV/PM <input type="checkbox"/> AOLV/PM <input type="checkbox"/> CLV/PM <input type="checkbox"/> EZOLV </div> <p>Sets the filter time constant used when monitoring motor speed during MEMOBUS/Modbus communications or with a communication option.</p>	0 ms (0 - 100 ms)

Sets the filter time constant when you monitor the output frequency or motor speed during MEMOBUS/Modbus communications or use of the communication option.

These are the MEMOBUS registers:

- 003EH (Output Frequency)
- 003FH (Output Frequency)
- 0044H (U1-05: Motor Speed)
- 00ACH (U1-05: Motor Speed)
- 00ADH (U1-05: Motor Speed)

■ H5-20: Communication Parameters Reload

No. (Hex.)	Name	Description	Default (Range)
H5-20 (0B57)	Communication Parameters Reload	<div style="display: flex; justify-content: space-between; align-items: center;"> <input type="checkbox"/> V/f <input type="checkbox"/> CL-V/f <input type="checkbox"/> OLV <input type="checkbox"/> CLV <input type="checkbox"/> AOLV <input type="checkbox"/> OLV/PM <input type="checkbox"/> AOLV/PM <input type="checkbox"/> CLV/PM <input type="checkbox"/> EZOLV </div> <p>Sets the function to immediately enable updated MEMOBUS/Modbus communications parameters.</p>	0 (0, 1)

0 : Reload at Next Power Cycle**1 : Reload Now**

Note:

- The setting value automatically returns to $H5-20 = 0$ after you enable MEMOBUS/Modbus communications parameter changes.
- The setting values of these parameters are enabled:
 - H5-01 [Drive Node Address]
 - H5-02 [Communication Speed Selection]
 - H5-03 [Communication Parity Selection]
 - H5-06 [Drive Transmit Wait Time]

■ H5-22: Speed Search from MODBUS

No. (Hex.)	Name	Description	Default (Range)
H5-22 (11CF)	Speed Search from MODBUS	V/f CL-V/f OLV CLV AOLV OLV/PM AOLV/PM CLV/PM EZOLV Enables the MEMOBUS/Modbus communication register Speed Search function (bit0 of 15DFH).	0 (0, 1)

0 : Disabled**1 : Enabled**

If you set $H5-22 = 1$ and $H1-xx = 62$ [Speed Search from Fref] at the same time, the drive will detect *oPE03* [Multi-Function Input Setting Err].

■ H5-25: Function 5A Register 1 Selection

No. (Hex.)	Name	Description	Default (Range)
H5-25 (1589) RUN	Function 5A Register 1 Selection	V/f CL-V/f OLV CLV AOLV OLV/PM AOLV/PM CLV/PM EZOLV Returns the contents of the specified MEMOBUS/Modbus communications register when responding to the master device.	0044H (U1-05) (0000H - FFFFH)

■ H5-26: Function 5A Register 2 Selection

No. (Hex.)	Name	Description	Default (Range)
H5-26 (158A) RUN	Function 5A Register 2 Selection	V/f CL-V/f OLV CLV AOLV OLV/PM AOLV/PM CLV/PM EZOLV Returns the contents of the specified MEMOBUS/Modbus communications register when responding to the master device.	0045H (U1-06) (0000H - FFFFH)

■ H5-27: Function 5A Register 3 Selection

No. (Hex.)	Name	Description	Default (Range)
H5-27 (158B) RUN	Function 5A Register 3 Selection	V/f CL-V/f OLV CLV AOLV OLV/PM AOLV/PM CLV/PM EZOLV Returns the contents of the specified MEMOBUS/Modbus communications register when responding to the master device.	0042H (U1-03) (0000H - FFFFH)

■ H5-28: Function 5A Register 4 Selection

No. (Hex.)	Name	Description	Default (Range)
H5-28 (158C) RUN	Function 5A Register 4 Selection	V/f CL-V/f OLV CLV AOLV OLV/PM AOLV/PM CLV/PM EZOLV Returns the contents of the specified MEMOBUS/Modbus communications register when responding to the master device.	0049H (U1-10) (0000H - FFFFH)

◆ H6: Pulse Train Input/Output

H6 parameters set the drive pulse train input and pulse train monitor. These parameters select input and monitor parameters and adjust the pulse train frequency.

A pulse train signal with a maximum single pulse of 32 kHz can be input to the drive input terminal RP. You can use the pulse train signal as the frequency reference, PID feedback value, PID setpoint value, and speed feedback for V/f Control mode.

A pulse train signal with a maximum frequency of 32 kHz can be output from the drive output terminal MP as the monitor value. Sinking mode and sourcing mode are supported.

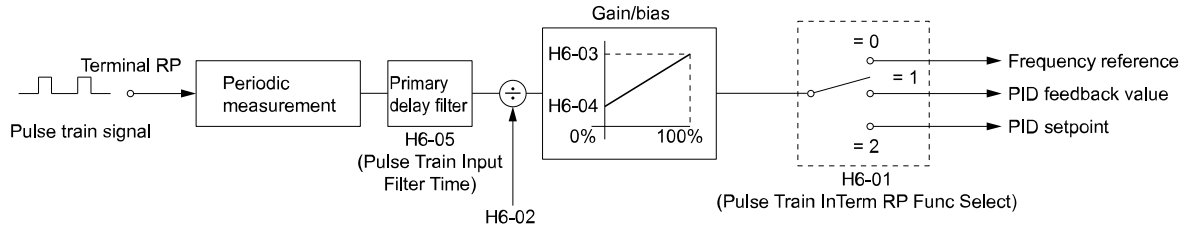

Figure 12.116 Pulse Train Input Block Diagram

■ H6-01: Terminal RP Pulse Train Function

No. (Hex.)	Name	Description	Default (Range)
H6-01 (042C)	Terminal RP Pulse Train Function	V/f CL-V/f OLV CLV AOLV OLV/PM AOLV/PM CLV/PM EZOLV Sets the function for pulse train input terminal RP.	0 (0 - 3)

0 : Frequency Reference

When $b1-01 = 4$ [Frequency Reference Selection 1 = Pulse Train Input] or $b1-15 = 4$ [Frequency Reference Selection 2 = Pulse Train Input], the drive inputs the frequency reference received from terminal RP.

1 : PID Feedback Value

The drive inputs the PID control feedback value received from terminal RP.

2 : PID Setpoint Value

The drive inputs the PID control target value received from terminal RP.

3 : Speed Feedback (V/F Control)

Select V/f Control method to enable simple encoder feedback.

Use motor speed feedback for better speed control precision. The drive compares the frequency reference to the motor speed feedback received from the encoder, and uses the ASR function to compensate for motor slip. You cannot use input terminal RP used for the simple encoder to detect the direction of motor rotation. Use a different method to detect motor rotation.

Use these methods to detect the direction of motor rotation.

- Use MFDI
Set MFDI $H1-xx = 7E$ [Reverse Rotation Identifier]. When the configured terminal is activated, the motor operates in Reverse run. When the terminal is deactivated, the motor operates in Forward run. Use an encoder that outputs 2-tracks (phase A, B) to detect the direction of motor rotation.
- Use the frequency reference
When you do not use the MFDI, the Forward/Reverse run command is the same as the direction of motor rotation.

Figure 12.117 shows speed control in Simple Closed Loop V/f Mode.

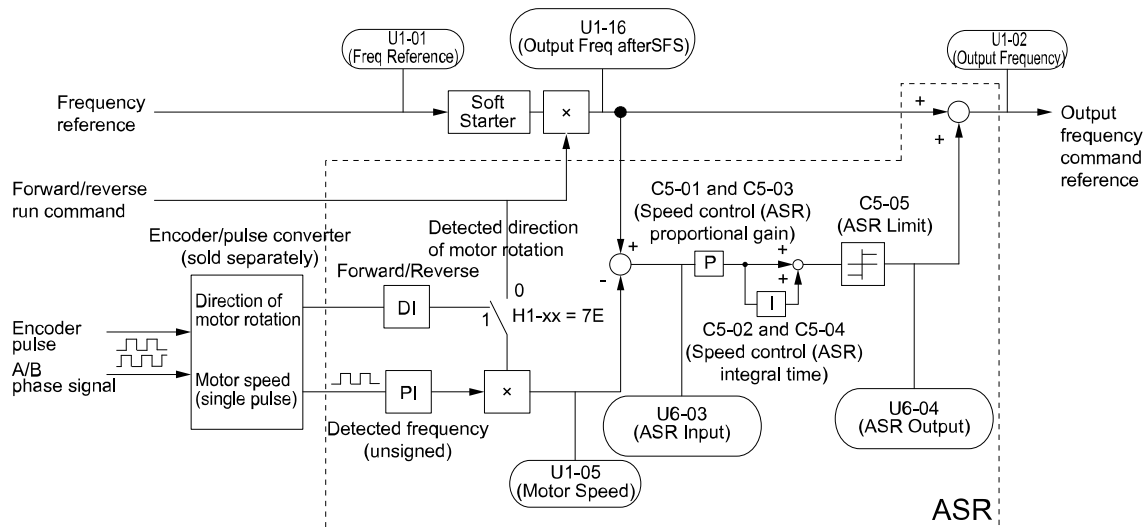

Figure 12.117 Simple Closed Loop Speed Control Block Diagram

Enable Simple Closed Loop V/f Mode

1. Connect the encoder output pulse wiring to terminal RP.

2. Set $A1-02 = 0$ [Control Method Selection = V/f Control].
3. Set $H6-01 = 3$.
4. Set $H6-02$ [Terminal RP Frequency Scaling] to the speed feedback (pulse train input signal) frequency at the time when the frequency reference is 100%.
Make sure that $H6-04$ [Terminal RP Function Bias] = 0% and $H6-03$ [Terminal RP Function Gain] = 100%.
5. Select the detection method for the direction of motor rotation.
When you use an MFDI, set $H1-xx = 7E$.
6. Set $C5$ parameters related to ASR gain and integral time to adjust responsiveness.

Note:

- Set $A1-02 = 0$ and $H6-01 = 3$ to show $C5$ parameters.
- You cannot use Simple Closed Loop V/f Mode with the Motor Switch function.

■ H6-02: Terminal RP Frequency Scaling

No. (Hex.)	Name	Description	Default (Range)
H6-02 (042D) RUN	Terminal RP Frequency Scaling	<div style="display: flex; justify-content: space-between; align-items: center;"> V/f CL-V/f OLV CLV AOLV OLV/PM AOLV/PM CLV/PM EZOLV </div> Sets the frequency of the pulse train input signal used when the item selected with $H6-01$ [Terminal RP Pulse Train Function] is input at 100%.	1440 Hz (100 - 32000 Hz)

■ H6-03: Terminal RP Function Gain

No. (Hex.)	Name	Description	Default (Range)
H6-03 (042E) RUN	Terminal RP Function Gain	<div style="display: flex; justify-content: space-between; align-items: center;"> V/f CL-V/f OLV CLV AOLV OLV/PM AOLV/PM CLV/PM EZOLV </div> Sets the gain used when the function in $H6-01$ [Terminal RP Pulse Train Function] is input to terminal RP.	100.0% (0.0 - 1000.0%)

■ H6-04: Terminal RP Function Bias

No. (Hex.)	Name	Description	Default (Range)
H6-04 (042F) RUN	Terminal RP Function Bias	<div style="display: flex; justify-content: space-between; align-items: center;"> V/f CL-V/f OLV CLV AOLV OLV/PM AOLV/PM CLV/PM EZOLV </div> Sets the bias used when the function in $H6-01$ [Terminal RP Pulse Train Function] is input to terminal RP. Sets a value at the time when the pulse train is 0 Hz.	0.0% (-100.0 - 100.0%)

■ H6-05: Terminal RP Filter Time

No. (Hex.)	Name	Description	Default (Range)
H6-05 (0430) RUN	Terminal RP Filter Time	<div style="display: flex; justify-content: space-between; align-items: center;"> V/f CL-V/f OLV CLV AOLV OLV/PM AOLV/PM CLV/PM EZOLV </div> Sets the time constant for the pulse train input primary delay filters.	0.10 s (0.00 - 2.00 s)

■ H6-06: Terminal MP Monitor Selection

No. (Hex.)	Name	Description	Default (Range)
H6-06 (0431) RUN	Terminal MP Monitor Selection	<div style="display: flex; justify-content: space-between; align-items: center;"> V/f CL-V/f OLV CLV AOLV OLV/PM AOLV/PM CLV/PM EZOLV </div> Sets a function for pulse train monitor output terminal MP. Sets the "x-xx" part of the $Ux-xx$ monitor.	102 (000, 031, 101, 102, 105, 116, 501, 502, 801 - 809, 821 - 825, 831 - 839, 851 - 855)

Note:

To use in through mode or when terminal MP is not used, set this parameter to 000 or 031.

When you use the pulse train monitor, make sure that you connect peripheral devices as specified by these load conditions:

Incorrect connections can make the characteristics not sufficient or cause mechanical damage.

- Use the pulse train monitor as the sourcing output.

Output Voltage VRL(V)	Load Impedance (kΩ)
5 V or more	1.5 kΩ or more
8 V or more	4.0 kΩ or more
10 V or more	10 kΩ or more

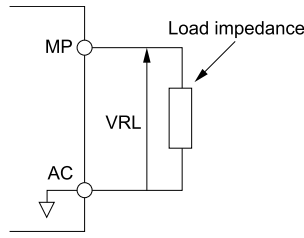

Figure 12.118 Circuit Diagram When Used as the Sourcing Output

- Use the pulse train monitor as the sinking input

External Power Supply (V)	12 VDC ± 10%, 15 VDC ± 10%
Sinking current (mA)	16 mA or less

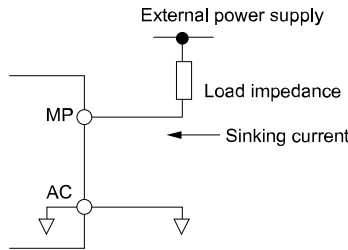

Figure 12.119 Circuit Diagram When Used as the Sinking Input

■ H6-07: Terminal MP Frequency Scaling

No. (Hex.)	Name	Description	Default (Range)
H6-07 (0432) RUN	Terminal MP Frequency Scaling	V/f CL-V/f OLV CLV AOLV OLV/PM AOLV/PM CLV/PM EZOLV Sets the frequency of the pulse train output signal used when the monitor set with H6-06 [Terminal MP Monitor Selection] is 100%.	1440 Hz (0 - 32000 Hz)

When H6-06 = 102 [Terminal MP Monitor Selection = Output Frequency] and H6-07 = 0, the pulse train output terminal MP outputs the same frequency as the drive output frequency.

■ H6-08: Terminal RP Minimum Frequency

No. (Hex.)	Name	Description	Default (Range)
H6-08 (043F)	Terminal RP Minimum Frequency	V/f CL-V/f OLV CLV AOLV OLV/PM AOLV/PM CLV/PM EZOLV Sets the minimum frequency of the pulse train signal that terminal RP can detect.	0.5 Hz (0.1 - 1000.0 Hz)

- When you input a pulse train frequency that is less than the value of H6-08, the pulse train input is 0.0 Hz.
- Set H6-01 = 0, 1, or 2 [Terminal RP Pulse Train Function = Frequency Reference, PID Feedback Value, or PID Setpoint Value] to enable this parameter.
- When H6-01 = 3 [Speed Feedback (V/F Control)], the drive applies the setting of F1-14 [Encoder Open-Circuit Detect Time] to the minimum frequency.

■ H6-09: Voltage Phase Sync MP Selection

No. (Hex.)	Name	Description	Default (Range)
H6-09 (156E)	Voltage Phase Sync MP Selection	V/f CL-V/f OLV CLV AOLV OLV/PM AOLV/PM CLV/PM EZOLV Set whether to output the pulse synchronized with drive output voltage phase from the pulse train monitor output terminal MP. This parameter is only enabled when H6-06 = 102 [Terminal MP Monitor Selection = Output Frequency] and H6-07 = 0 [Terminal MP Frequency Scaling = 0 Hz].	0 (0, 1)

0 : Disabled

1 : Enabled

◆ H7: Virtual MFIO Selection

The virtual I/O function performs the following.

- Inputs the result of the output from the MFDO terminal to the MFDI terminal without external wiring.
- Inputs the result of the output from the MFAO terminal to the MFAI terminal without external wiring.

This can simplify the external wiring and reduce the cost.

WARNING! Sudden Movement Hazard. Before you do a test run, make sure that the setting values for virtual input and output function parameters are correct. Virtual input and output functions can have different default settings and operation than wired input and output functions. Incorrect function settings can cause serious injury or death.

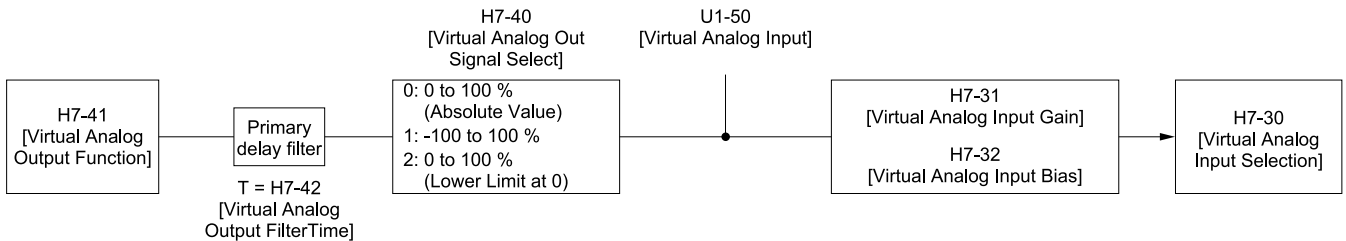

Figure 12.120 Virtual Analog I/O Functional Block Diagram

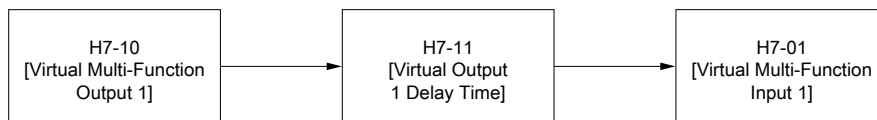

Figure 12.121 Virtual Digital I/O Functional Block Diagram

Note:

- Refer to H1-xx [Multi-Function Digital Input Setting Values on page 842](#) for more information on the virtual digital input setting values.
- Refer to H2-xx [MFDO Setting Values on page 869](#) for more information on the virtual digital output setting values.
- Refer to H3-xx [Multi-Function Analog Input Terminal Settings on page 890](#) for more information on the virtual analog input setting values.
- Refer to H4-xx [H4: Analog Outputs on page 896](#) for more information on the virtual analog output setting values.
- You cannot set 0 [3-Wire Sequence] and 20 or 2F [External Fault] to H7-01 to H7-04 [Virtual Multi-Function Input 1 to 4].
- When you will not use the terminal, set H7-01 to H7-04 = F. The through mode function is not supported.
- You cannot use the virtual I/O function selection and the multi-function input for DI-A3 at the same time.

■ H7-00: Virtual MFIO selection

No. (Hex.)	Name	Description	Default (Range)
H7-00 (116F) Expert	Virtual MFIO selection	V/f CL-V/f OLV CLV AOLV OLV/PM AOLV/PM CLV/PM EZOLV Sets the function to enable and disable the virtual I/O function. Set this parameter to 1 to operate the virtual I/O function.	0 (0, 1)

0 : Disabled

1 : Enabled

■ H7-01: Virtual Multi-Function Input 1

No. (Hex.)	Name	Description	Default (Range)
H7-01 (1185) Expert	Virtual Multi-Function Input 1	V/f CL-V/f OLV CLV AOLV OLV/PM AOLV/PM CLV/PM EZOLV Sets the function that enters the virtual input set in H7-10 [Virtual Multi-Function Output 1].	F (1 - 19F)

■ H7-02: Virtual Multi-Function Input 2

No. (Hex.)	Name	Description	Default (Range)
H7-02 (1186) Expert	Virtual Multi-Function Input 2	V/f CL-V/f OLV CLV AOLV OLV/PM AOLV/PM CLV/PM EZOLV Sets the function that enters the virtual input set in H7-12 [Virtual Multi-Function Output 2].	F (1 - 19F)

■ H7-03: Virtual Multi-Function Input 3

No. (Hex.)	Name	Description	Default (Range)
H7-03 (1187) Expert	Virtual Multi-Function Input 3	<div style="display: flex; justify-content: space-between; gap: 5px;"> V/f CL-V/f OLV CLV AOLV OLV/PM AOLV/PM CLV/PM EZOLV </div> Sets the function that enters the virtual input set in H7-14 [Virtual Multi-Function Output 3].	F (1 - 19F)

■ H7-04: Virtual Multi-Function Input 4

No. (Hex.)	Name	Description	Default (Range)
H7-04 (1188) Expert	Virtual Multi-Function Input 4	<div style="display: flex; justify-content: space-between; gap: 5px;"> V/f CL-V/f OLV CLV AOLV OLV/PM AOLV/PM CLV/PM EZOLV </div> Sets the function that enters the virtual input set in H7-16 [Virtual Multi-Function Output 4].	F (1 - 19F)

■ H7-10: Virtual Multi-Function Output 1

No. (Hex.)	Name	Description	Default (Range)
H7-10 (11A4) Expert	Virtual Multi-Function Output 1	<div style="display: flex; justify-content: space-between; gap: 5px;"> V/f CL-V/f OLV CLV AOLV OLV/PM AOLV/PM CLV/PM EZOLV </div> Sets the function for virtual digital output 1.	F (0 - 1A7)

■ H7-11: Virtual Output 1 Delay Time

No. (Hex.)	Name	Description	Default (Range)
H7-11 (11A5) Expert	Virtual Output 1 Delay Time	<div style="display: flex; justify-content: space-between; gap: 5px;"> V/f CL-V/f OLV CLV AOLV OLV/PM AOLV/PM CLV/PM EZOLV </div> Sets the minimum ON time for virtual digital output 1.	0.1 s (0.0 - 25.0 s)

■ H7-12: Virtual Multi-Function Output 2

No. (Hex.)	Name	Description	Default (Range)
H7-12 (11A6) Expert	Virtual Multi-Function Output 2	<div style="display: flex; justify-content: space-between; gap: 5px;"> V/f CL-V/f OLV CLV AOLV OLV/PM AOLV/PM CLV/PM EZOLV </div> Sets the function for virtual digital output 2.	F (0 - 1A7)

■ H7-13: Virtual Output 2 Delay Time

No. (Hex.)	Name	Description	Default (Range)
H7-13 (11A7) Expert	Virtual Output 2 Delay Time	<div style="display: flex; justify-content: space-between; gap: 5px;"> V/f CL-V/f OLV CLV AOLV OLV/PM AOLV/PM CLV/PM EZOLV </div> Sets the minimum ON time for virtual digital output 2.	0.1 s (0.0 - 25.0 s)

■ H7-14: Virtual Multi-Function Output 3

No. (Hex.)	Name	Description	Default (Range)
H7-14 (11A8) Expert	Virtual Multi-Function Output 3	<div style="display: flex; justify-content: space-between; gap: 5px;"> V/f CL-V/f OLV CLV AOLV OLV/PM AOLV/PM CLV/PM EZOLV </div> Sets the function for virtual digital output 3.	F (0 - 1A7)

■ H7-15: Virtual Output 3 Delay Time

No. (Hex.)	Name	Description	Default (Range)
H7-15 (11A9) Expert	Virtual Output 3 Delay Time	<div style="display: flex; justify-content: space-between; gap: 5px;"> V/f CL-V/f OLV CLV AOLV OLV/PM AOLV/PM CLV/PM EZOLV </div> Sets the minimum ON time for virtual digital output 3.	0.1 s (0.0 - 25.0 s)

■ H7-16: Virtual Multi-Function Output 4

No. (Hex.)	Name	Description	Default (Range)
H7-16 (11AA) Expert	Virtual Multi-Function Output 4	V/f CL-V/f OLV CLV AOLV OLV/PM AOLV/PM CLV/PM EZOLV Sets the function for virtual digital output 4.	F (0 - 1A7)

■ H7-17: Virtual Output 4 Delay Time

No. (Hex.)	Name	Description	Default (Range)
H7-17 (11AB) Expert	Virtual Output 4 Delay Time	V/f CL-V/f OLV CLV AOLV OLV/PM AOLV/PM CLV/PM EZOLV Sets the minimum ON time for virtual digital output 4.	0.1 s (0.0 - 25.0 s)

■ H7-30: Virtual Analog Input Selection

No. (Hex.)	Name	Description	Default (Range)
H7-30 (1177) Expert	Virtual Analog Input Selection	V/f CL-V/f OLV CLV AOLV OLV/PM AOLV/PM CLV/PM EZOLV Sets the virtual analog input function.	F (0 - 32)

■ H7-31: Virtual Analog Input Gain

No. (Hex.)	Name	Description	Default (Range)
H7-31 (1178) RUN Expert	Virtual Analog Input Gain	V/f CL-V/f OLV CLV AOLV OLV/PM AOLV/PM CLV/PM EZOLV Sets the virtual analog input gain.	100.0% (-999.9 - 999.9%)

■ H7-32: Virtual Analog Input Bias

No. (Hex.)	Name	Description	Default (Range)
H7-32 (1179) RUN Expert	Virtual Analog Input Bias	V/f CL-V/f OLV CLV AOLV OLV/PM AOLV/PM CLV/PM EZOLV Sets the virtual analog input bias.	0.0% (-999.9 - 999.9%)

■ H7-40: Virtual Analog Out Signal Select

No. (Hex.)	Name	Description	Default (Range)
H7-40 (1163)	Virtual Analog Out Signal Select	V/f CL-V/f OLV CLV AOLV OLV/PM AOLV/PM CLV/PM EZOLV Sets the signal level of the virtual analog output.	0 (0 - 2)

0 : 0 to 100% (Absolute Value)

1 : -100 to 100%

2 : 0 to 100% (Lower Limit at 0)

■ H7-41: Virtual Analog Output Function

No. (Hex.)	Name	Description	Default (Range)
H7-41 (1164)	Virtual Analog Output Function	V/f CL-V/f OLV CLV AOLV OLV/PM AOLV/PM CLV/PM EZOLV Sets the monitor ($Ux-xx$) to be output from the virtual analog output.	102 (0 - 9999)

Note:

Set the $x-xx$ part of the $Ux-xx$ [Monitor]. For example, set $H7-41 = 102$ to monitor $U1-02$ [Output Frequency].

When the x part of Ux is a letter, replace the letter (hexadecimal number) with a decimal number. For example, set $H7-41 = 1301$ to monitor $Ud-01$.

■ H7-42: Virtual Analog Output FilterTime

No. (Hex.)	Name	Description	Default (Range)
H7-42 (1165)	Virtual Analog Output FilterTime	V/f CL-V/f OLV CLV AOLV OLV/PM AOLV/PM CLV/PM EZOLV Sets the time constant for a primary filter of the virtual analog output.	0.00 s (0.00 - 2.00 s)

12.9 L: Protection Functions

L parameters set the following functions.

- Motor Overload Protection
- Operation During Momentary Power Loss
- Stall Prevention
- Speed Detection
- Auto Restart
- Detection of Overtorque/Undertorque
- Torque Limit
- Hardware Protection

◆ L1: Motor Protection

L1 parameters set the motor overload protection function.

■ Motor Protection Using Positive Temperature Coefficient (PTC) Thermistors

The temperature resistance characteristics of three PTC thermistors in the motor stator winding protect the motor from overheat.

The PTC thermistor must have the characteristics shown in [Figure 12.122](#) for each motor phase.

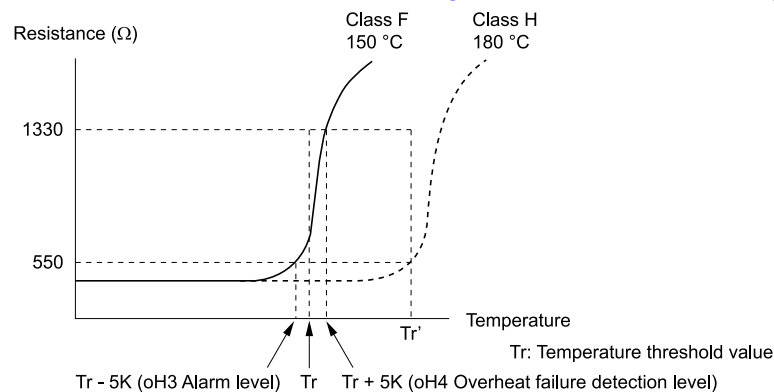

Figure 12.122 PTC Thermistor Temperature and Resistance

When the PTC input signal input to the drive is more than the overload alarm level, the drive detects *oH3* [*Motor Overheat (PTC Input)*]. The drive continues the operation set in *L1-03* [*Motor Thermistor oH Alarm Select*]. By factory default, *oH3* flashes on the keypad and the drive continues operation.

The overheat fault level triggers an *oH4* [*Motor Overheat Fault (PTC Input)*] fault, and outputs a fault signal. The drive outputs a fault signal, and uses the stop method set in *L1-04* [*Motor Thermistor oH Fault Select*] to stop the motor.

Note:

PTC is an acronym for Positive Temperature Coefficient.

[Figure 12.123](#) shows the configuration procedure when you use terminal A3.

1. Connect the PTC thermistor input from the motor to analog input terminal A3 on the drive.

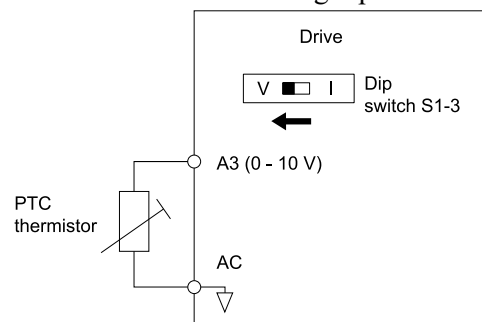

Figure 12.123 Connect Motor PTC

2. Set drive DIP switch S1-3 to V (voltage) and set DIP switch S4 to PTC.

3. Set these MFAI terminals:
 - Set H3-05 = 0 [Terminal A3 Signal Level Select = 0 to 10V (Lower Limit at 0)].
 - Set H3-06 = E [Terminal A3 Function Selection = Motor Temperature (PTC input)].
4. Set these L1 parameters:
 - L1-03 [Motor Thermistor oH Alarm Select]
 - L1-04 [Motor Thermistor oH Fault Select]
 - L1-05 [Motor Thermistor Filter Time]

■ L1-01: Motor Overload (oL1) Protection

No. (Hex.)	Name	Description	Default (Range)
L1-01 (0480)	Motor Overload (oL1) Protection	V/f CL-V/f OLV CLV AOLV OLV/PM AOLV/PM CLV/PM EZOLV Sets the motor overload protection with electronic thermal protectors.	Determined by A1-02 (0 - 6)

This parameter enables and disables the motor overload protection with electronic thermal protectors. The cooling capability of the motor changes when the speed control range of the motor changes. Use an electronic thermal protector that aligns with the permitted load characteristics of the motor to select motor protection. The electronic thermal protector of the drive uses these items to calculate motor overload tolerance and supply overload protection for the motor:

- Output current
- Output frequency
- Motor thermal characteristics
- Time characteristics

If the drive detects motor overload, the drive will trigger an oL1 [Motor Overload] and stop the drive output. Set H2-01 = 1F [Term M1-M2 Function Selection = Motor Overload Alarm (oL1)] to set a motor overload alarm. If the motor overload level is more than 90% of the oL1 detection level, the output terminal activates and triggers an overload alarm.

0 : Disable

Disable motor protection when motor overload protection is not necessary or when the drive is operating more than one motor.

Refer to Figure 12.124 for an example of the circuit configuration to connect more than one motor to one drive.

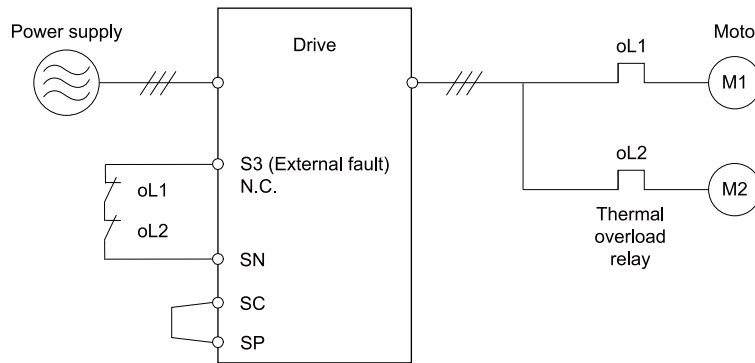
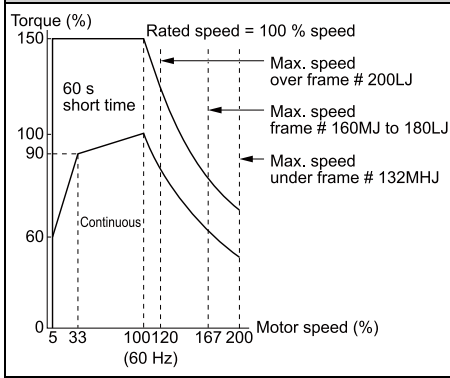

Figure 12.124 Protection Circuit Configuration to Connect More than One Motor to One Drive

NOTICE: When you connect more than one motor to one drive or when the motor amp rating is higher than the drive amp rating, set L1-01 = 0 [Motor Overload (oL1) Protection = Disabled] and install thermal overload relays for each motor. The electronic thermal protection of the drive will not function and it can cause damage to the motor.

1 : Variable Torque

Use this setting for general-purpose motors with a 60 Hz base frequency. The overload tolerance decreases as motor speed decreases because the cooling fan speed decreases and the ability of the motor to cool decreases in the low speed range. The overload tolerance characteristics of the motor change the trigger point for the electronic thermal protector. This provides motor overheat protection from low speed to high speed across the full speed range.

Load Tolerance	Cooling Capability	Overload Characteristics (at 100% motor load)
	<p>This motor is designed to operate with commercial line power. Operate at a 60 Hz base frequency to maximize the motor cooling ability.</p>	<p>If the motor operates at frequencies less than 60 Hz, the drive will detect <i>oLL</i>. The drive triggers a fault relay output and the motor coasts to stop.</p>

2 : Constant Torque 10:1 Speed Range

Use this setting for drive-dedicated motors with a speed range for constant torque of 1:10.

The speed control for this motor is 10% to 100% when at 100% load. Operating slower than 10% speed at 100% load will cause motor overload.

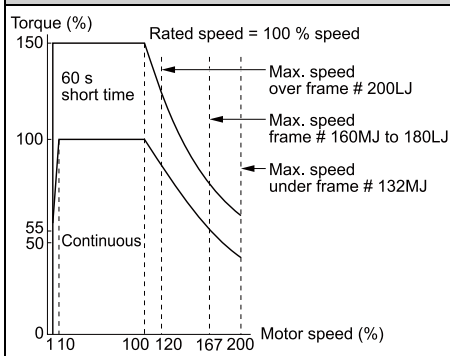
Load Tolerance	Cooling Capability	Overload Characteristics (at 100% motor load)
	<p>This motor is designed to withstand increased temperatures during continuous operation in the low speed range (10% base frequency).</p>	<p>The motor operates continuously at 10% to 100% base frequency. Operating slower than 10% speed at 100% load will cause motor overload.</p>

3 : Constant Torque 100:1 SpeedRange

Use this setting for vector motors with a speed range for constant torque of 1:100.

The speed control for this motor is 1% to 100% when at 100% load. Operating slower than 1% speed at 100% load will cause motor overload.

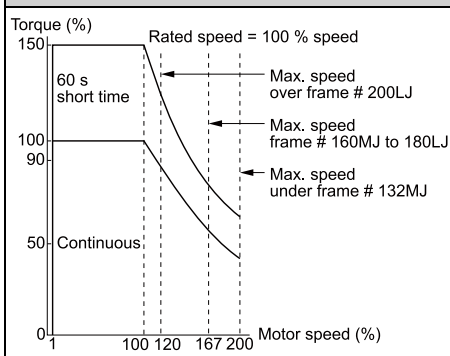
Load Tolerance	Cooling Capability	Overload Characteristics (at 100% motor load)
	<p>This motor is designed to withstand increased temperatures during continuous operation in the low speed range (1% base frequency).</p>	<p>The motor operates continuously at 1% to 100% base frequency. Operating slower than 1% speed at 100% load will cause motor overload.</p>

4 : PM Variable Torque

Use this setting for PM motors with derated torque characteristics.

The overload tolerance decreases as motor speed decreases because the cooling fan speed decreases and the ability of the motor to cool decreases in the low speed range.

The overload tolerance characteristics of the motor change the trigger point for the electronic thermal protector. This provides motor overheat protection from low speed to high speed across the full speed range.

12.9 L: Protection Functions

Load Tolerance	Cooling Capability	Overload Characteristics (at 100% motor load)
	<p>This motor is designed to withstand increased temperatures during continuous operation at rated speed and rated torque.</p>	<p>If the motor operates continuously at lower speed than rated rotation speed at more than 100% torque, the drive will detect <i>oLL</i>. The drive triggers a fault relay output and the motor coasts to stop.</p>

5 : PM Constant Torque

Use this setting with a PM motor for constant torque that has a speed range for constant torque of 1:500.

The speed control for this motor is 0.2% to 100% when at 100% load. Operating slower than 0.2% speed at 100% load will cause motor overload.

Load Tolerance	Cooling Capability	Overload Characteristics (at 100% motor load)
	<p>This motor is designed to withstand increased temperatures during continuous operation in the low speed range (0.2% base frequency).</p>	<p>The motor operates continuously at 0.2% to 100% rated speed. Operating slower than 0.2% speed at 100% load will cause motor overload.</p>

6 : Variable Torque (50Hz)

Use this setting for general-purpose motors with a 50 Hz base frequency.

The overload tolerance decreases as motor speed decreases because the cooling fan speed decreases and the ability of the motor to cool decreases in the low speed range.

The overload tolerance characteristics of the motor change the trigger point for the electronic thermal protector. This provides motor overheat protection from low speed to high speed across the full speed range.

Load Tolerance	Cooling Capability	Overload Characteristics (at 100% motor load)
	<p>This motor is designed to operate with commercial line power. Operate at a 50 Hz base frequency to maximize the motor cooling ability.</p>	<p>If the motor operates at frequencies less than commercial line power, the drive will detect <i>oLL</i>. The drive triggers a fault relay output and the motor coasts to stop.</p>

■ L1-02: Motor Overload Protection Time

No. (Hex.)	Name	Description	Default (Range)
L1-02 (0481)	Motor Overload Protection Time	<p><input checked="" type="checkbox"/> Vf <input checked="" type="checkbox"/> CL-Vf <input checked="" type="checkbox"/> OLV <input checked="" type="checkbox"/> CLV <input checked="" type="checkbox"/> AOLV <input checked="" type="checkbox"/> OLV/PM <input checked="" type="checkbox"/> AOLV/PM <input checked="" type="checkbox"/> CLV/PM <input checked="" type="checkbox"/> EZOLV</p> <p>Sets the operation time for the electronic thermal protector of the drive to prevent damage to the motor. Usually it is not necessary to change this setting.</p>	1.0 min (0.1 - 5.0 min)

Set the overload tolerance time to the length of time that the motor can operate at 150% load from continuous operation at 100% load.

When the motor operates at 150% load continuously for 1 minute after continuous operation at 100% load (hot start), the default setting triggers the electronic thermal protector.

Figure 12.125 shows an example of the electronic thermal protector operation time. Motor overload protection operates in the range between a cold start and a hot start.

This example shows a general-purpose motor operating at the base frequency with L1-02 set to 1.0 min.

- Cold start
Shows the motor protection operation time characteristics when the overload occurs immediately after starting operation from a complete stop.
- Hot start
Shows the motor protection operation time characteristics when overload occurs from continuous operation below the motor rated current.

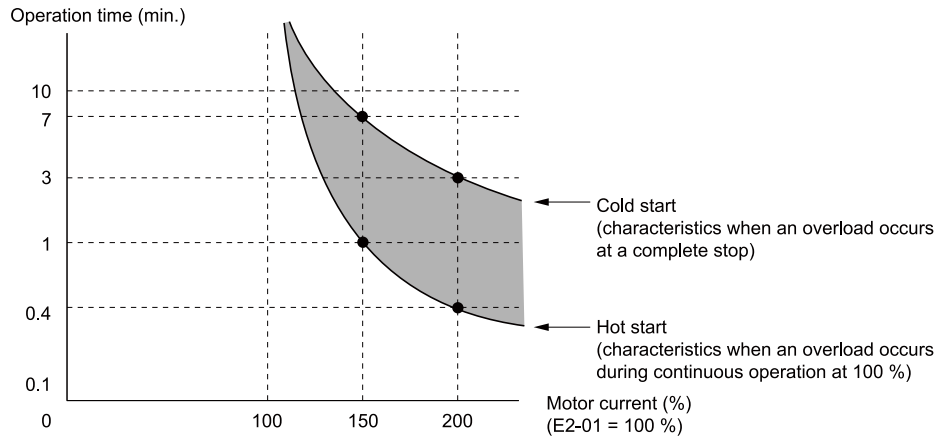

Figure 12.125 Protection Operation Time for a General-purpose Motor at Rated Output Frequency

■ L1-03: Motor Thermistor oH Alarm Select

No. (Hex.)	Name	Description	Default (Range)
L1-03 (0482)	Motor Thermistor oH Alarm Select	V/f CL-V/f OLV CLV AOLV OLV/PM AOLV/PM CLV/PM EZOLV Sets drive operation when the PTC input signal entered into the drive is at the oH3 [Motor Overheat Alarm] detection level.	3 (0 - 3)

0 : Ramp to Stop

The drive ramps the motor to stop in the deceleration time. Fault relay output terminal MA-MC turns ON, and MB-MC turns OFF.

1 : Coast to Stop

The output turns off and the motor coasts to stop. Fault relay output terminal MA-MC turns ON, and MB-MC turns OFF.

2 : Fast Stop (Use C1-09)

The drive stops the motor in the deceleration time set in C1-09 [Fast Stop Time]. Fault relay output terminal MA-MC turns ON, and MB-MC turns OFF.

3 : Alarm Only

The keypad shows oH3 and the drive continues operation. The output terminal set for Alarm [H2-01 to H2-03 = 10] activates.

■ L1-04: Motor Thermistor oH Fault Select

No. (Hex.)	Name	Description	Default (Range)
L1-04 (0483)	Motor Thermistor oH Fault Select	V/f CL-V/f OLV CLV AOLV OLV/PM AOLV/PM CLV/PM EZOLV Sets the drive operation when the PTC input signal to the drive is at the oH4 [Motor Overheat Fault (PTC Input)] detection level.	1 (0 - 2)

0 : Ramp to Stop

The drive ramps the motor to stop in the deceleration time. Fault relay output terminal MA-MC turns ON, and MB-MC turns OFF.

1 : Coast to Stop

The output turns OFF and the motor coasts to stop. Fault relay output terminal MA-MC turns ON, and MB-MC turns OFF.

2 : Fast Stop (Use C1-09)

The drive stops the motor in the deceleration time set in *C1-09 [Fast Stop Time]*. Fault relay output terminal MA-MC turns ON, and MB-MC turns OFF.

■ **L1-05: Motor Thermistor Filter Time**

No. (Hex.)	Name	Description	Default (Range)
L1-05 (0484)	Motor Thermistor Filter Time	<div style="display: flex; justify-content: space-between; font-size: 0.8em;"> V/f CL-V/f OLV CLV AOLV OLV/PM AOLV/PM CLV/PM EZOLV </div> <p>Sets the primary delay time constant for the PTC input signal entered to the drive. This parameter prevents accidental motor overheating faults.</p>	0.20 s (0.00 - 10.00 s)

■ **L1-08: oL1 Current Level**

No. (Hex.)	Name	Description	Default (Range)
L1-08 (1103)	oL1 Current Level	<div style="display: flex; justify-content: space-between; font-size: 0.8em;"> V/f CL-V/f OLV CLV AOLV OLV/PM AOLV/PM CLV/PM EZOLV </div> <p>Sets the reference current for the motor 1 thermal overload detection. When the current level > 0.0 A, you cannot set this value < 10% of drive rated current.</p>	0.0 A (0.0 A or 10% to 150% of the drive rated current)

When *L1-08 = 0.0 A*, the drive uses *E2-01 [Motor Rated Current (FLA)]* to detect the motor overload protection. In PM control mode, the drive uses *E5-03 [PM Motor Rated Current (FLA)]* to detect the motor overload protection.

When *L1-08 ≠ 0.0 A*, the set value is the reference for motor overload protection.

Note:

- The display units are different for different models:
 - Models 2004 - 2042, 4002 - 4023: 0.01 A
 - Models 2056 - 2415, 4031 - 4H12: 0.1 A
- When the current level > 0.0 A, you cannot set this value < 10% of drive rated current.

■ **L1-09: oL1 Current Level for Motor 2**

No. (Hex.)	Name	Description	Default (Range)
L1-09 (1104)	oL1 Current Level for Motor 2	<div style="display: flex; justify-content: space-between; font-size: 0.8em;"> V/f CL-V/f OLV CLV AOLV OLV/PM AOLV/PM CLV/PM EZOLV </div> <p>Sets the reference current for the motor 2 thermal overload detection. When the current level > 0.0 A, you cannot set this value < 10% of drive rated current.</p>	0.0 A (0.0 A or 10 to 150% of the drive rated current)

When *L1-09 = 0.0 A*, the drive uses *E4-01 [Motor 2 Rated Current]* to detect the motor overload protection.

When *L1-09 ≠ 0.0 A*, the set value is the reference for motor overload protection.

Note:

- The display units are different for different models:
 - Models 2004 - 2042, 4002 - 4023: 0.01 A
 - Models 2056 - 2415, 4031 - 4H12: 0.1 A
- When the current level > 0.0 A, you cannot set this value < 10% of drive rated current.

■ **L1-13: Motor Overload Memory Selection**

No. (Hex.)	Name	Description	Default (Range)
L1-13 (046D)	Motor Overload Memory Selection	<div style="display: flex; justify-content: space-between; font-size: 0.8em;"> V/f CL-V/f OLV CLV AOLV OLV/PM AOLV/PM CLV/PM EZOLV </div> <p>Sets the function that keeps the current electronic thermal protector value when the drive stops receiving power.</p>	1 (0, 1)

0 : Disabled

1 : Enabled

Sets if the drive will calculate the motor again when the drive is energized again.

◆ **L2: Power Loss Ride Through**

L2 parameters set the drive operation during momentary power loss and the KEB Ride-Thru function method of operation.

■ KEB Ride-Thru Function

KEB is an acronym for Kinetic Energy Backup. If the drive detects a power loss or momentary power loss, it will quickly decelerate the motor. The drive uses regenerative energy from the motor to keep the main circuit operating. When you return power during motor deceleration, the drive returns operation to the status before the power loss. The KEB Ride-Thru function is different than other functions for continuous operation. If the drive detects momentary power loss, the motor will ramp to stop. It will not coast to stop. This function is applicable for applications in which it is necessary to prevent materials from running out, for example control for film and fiber lines.

The KEB Ride-Thru function has 4 methods of operation. Parameter *L2-29 [Kinetic Energy Backup Method]* sets the method.

When you use the KEB Ride-Thru function with one drive, set *L2-29 = 0, 1 [Single Drive KEB Ride-Thru 1, Single Drive KEB Ride-Thru 2]*.

If deceleration in coordination with more than one drive is necessary, for example textile machinery line systems, set *L2-29 = 2, 3 [System KEB Ride-Thru 1, System KEB Ride-Thru 2]*.

Table 12.73 KEB Ride-Thru Function Operation Method

L2-29	Kinetic Energy Backup Method	Operation	Configuration Precautions
0	Single Drive KEB Ride-Thru 1	The drive uses regenerative energy from the motor to keep the DC bus voltage at the level set in <i>L2-11 [KEB DC Bus Voltage Setpoint]</i> while it adjusts the rate of deceleration. The KEB operation continues while the drive adjusts the deceleration rate with the setting of <i>C1-09 [Fast Stop Time]</i> .	<ul style="list-style-type: none"> Set <i>C1-09</i> correctly to prevent <i>Uv1 [DC Bus Undervoltage]</i> and <i>ov [Overvoltage]</i>. If the drive detects <i>Uv1</i> during the KEB operation, decrease the value set in <i>C1-09</i>. If the drive detects <i>ov</i> during the KEB operation, increase the value set in <i>C1-09</i>.
1	Single Drive KEB Ride-Thru 2	The drive uses information about the inertia of the connected machinery to find the deceleration rate necessary to keep the DC bus voltage at the level set in parameter <i>L2-11</i> . The drive uses system inertia to calculate the deceleration time. You cannot adjust this value.	<ul style="list-style-type: none"> If the drive detects <i>Uv1</i> during the KEB operation, increase the setting value of <i>L3-20 [DC Bus Voltage Adjustment Gain]</i> and <i>L3-21 [OV Suppression Accel/Decel P Gain]</i>. If the drive detects <i>ov</i> during the KEB operation, decrease the setting values of <i>L3-20</i> and <i>L3-21</i>.
2	System KEB Ride-Thru 1	The drive does not monitor the DC bus voltage. The drive decelerates at the KEB deceleration time set in <i>L2-06</i> . Use <i>L2-06</i> to set the time necessary to decelerate from the current frequency reference to 0 Hz. More than one drive can decelerate and keep a constant speed ratio between drives.	Use the dynamic braking option with System KEB Ride-Thru 1.
3	System KEB Ride-Thru 2	The drive uses the KEB deceleration time set in <i>L2-06</i> to decelerate and it also monitors the DC bus voltage. If the voltage level increases, the drive momentarily holds the frequency to prevent an <i>ov</i> before it continues to decelerate.	If you cannot use the dynamic braking option, use System KEB Ride-Thru 2.

■ KEB Ride Thru Start

When *L2-01 = 3, 4, 5 [Power Loss Ride Through Select = Kinetic Energy Backup: L2-02, Kinetic Energy Backup: CPU Power, Kinetic Energy Backup: DecelStop]*, the drive starts the KEB operation immediately after it detects a momentary power loss. When one of these conditions occur, the drive will activate KEB Ride-Thru:

- KEB Ride-Thru 1 set for the MFDI terminal becomes enabled (terminal is deactivated when *H1-xx = 65* or terminal is activated when *H1-xx = 66*).
The drive uses the mode selected *L2-29 [Kinetic Energy Backup Method]* to start KEB operation.
- KEB Ride-Thru 2 set for the MFDI terminal becomes enabled (terminal is deactivated when *H1-xx = 7A* or terminal is activated when *H1-xx = 7B*).
The drive automatically starts Single KEB Ride-Thru 2 and it ignores the setting of *L2-29*.
- The DC bus voltage is less than the level set in *L2-05 [Undervoltage Detection Lvl (Uv1)]*.
The KEB operation will start as specified in *L2-29*.

Note:

If you try to set KEB Ride-Thru 1 and 2 to the MFDI terminals at the same time, it will trigger *oPE03 [Multi-Function Input Setting Err]*.

In this example, the drive detects that the DC bus voltage is less than the level set in *L2-05* and starts the KEB operation. When you return power during KEB operation, the drive will continue KEB operation when the KEB Ride-Thru is input, although the time set in *L2-10 [Minimum KEB Time]* expired. The motor accelerates again after you cancel the KEB Ride-Thru.

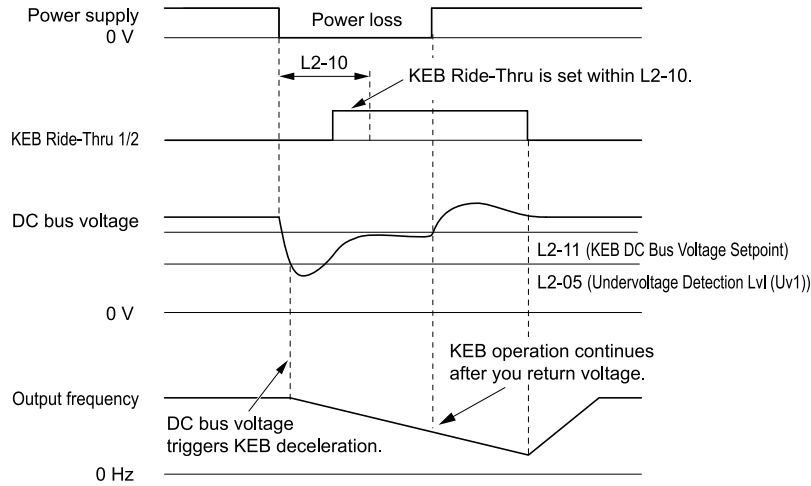

Figure 12.126 KEB Operation through KEB Ride-Thru Input

■ KEB Ride-Thru End Detection

Parameter *L2-01 [Power Loss Ride Through Select]* and a digital input programmed for KEB set the KEB function end detection.

Use the Momentary Power Loss Ride-Thru Time to Cancel KEB Operation

shows an example with this configuration:

- *L2-01 = 3 [Kinetic Energy Backup: L2-02]* is set.
- KEB Ride-Thru is not used.

The drive starts deceleration through KEB operation. When the time set in *L2-10 [Minimum KEB Time]* expires, the drive stops the KEB operation and then it accelerates the motor again until it is at the frequency reference value used before the power loss.

If you do not return the DC bus voltage in the time set in *L2-02 [Power Loss Ride Through Time]*, the drive detects *Uv1 [DC Bus Undervoltage]* and the drive turns off its output.

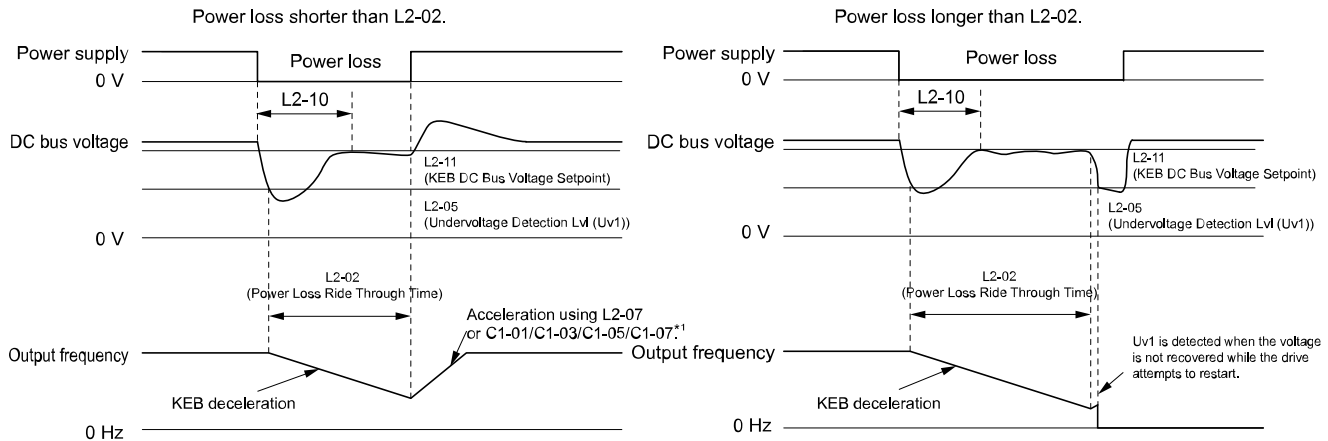

Figure 12.127 Cancel the KEB Operation after the Momentary Power Loss Ride-Thru Time Is Expired without KEB Ride-Thru

*1 When *L2-07 = 0.00 [Kinetic Energy Backup Accel Time = 0.00 s]*, the drive accelerates again as specified by the applicable *Acceleration Time [C1-01, C1-03, C1-05, C1-07]*, and usual operation continues.

Use the Momentary Power Loss Ride-Thru Time and KEB Ride-Thru to Cancel KEB Operation

shows an example with this configuration:

- *L2-01 = 3*.
- Use *KEB Ride-Thru 1 [H1-xx = 65, 66]* or *KEB Ride-Thru 2 [H1-xx = 7A, 7B]*.

The drive starts deceleration through KEB operation. The drive decelerates for the time set in parameter *L2-10*, then it measures the DC bus voltage and the status of the digital input terminal set for KEB Ride-Thru. When the DC bus voltage is less than the level set in *L2-11 [KEB DC Bus Voltage Setpoint]*, or if the KEB digital input is active, KEB deceleration continues. When the DC bus voltage is more than the level set in *L2-11*, the drive ends KEB operation. The drive accelerates the motor to the frequency reference value before the power loss, and usual

operation continues. If the time set in $L2-02$ is expired, the drive detects $Uv1$. When you cancel the KEB Ride-Thru, the motor accelerates again, and usual operation continues.

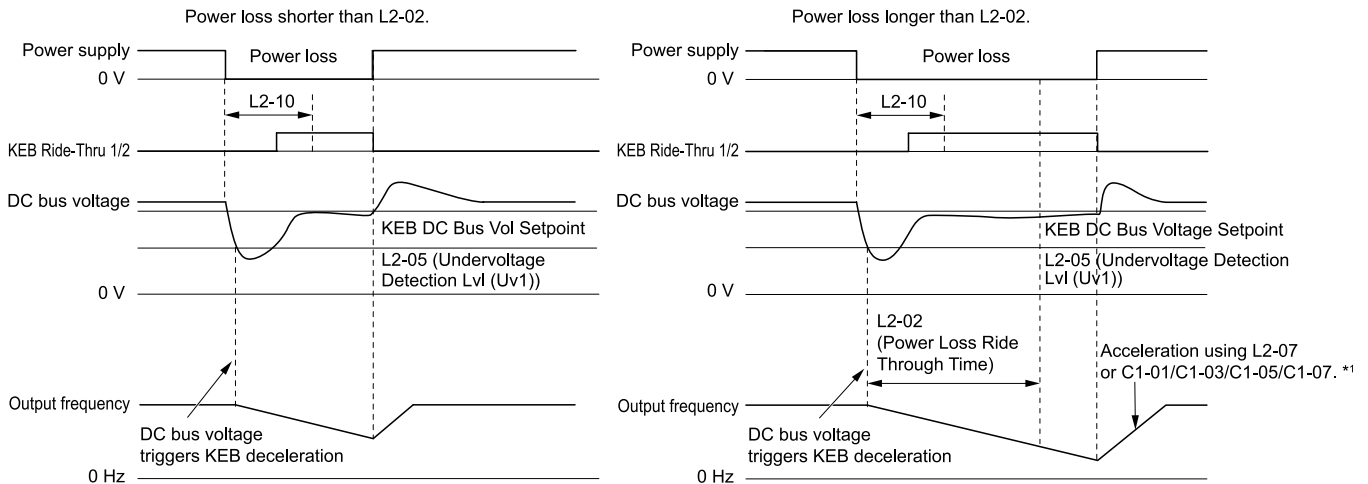

Figure 12.128 Use the Momentary Power Loss Ride-Through Time and KEB Ride-Thru to Cancel KEB Operation

*1 When $L2-07 = 0.00$, the drive accelerates again as specified by the applicable *Acceleration Time* [$C1-01$, $C1-03$, $C1-05$, $C1-07$], and usual operation continues.

Cancel KEB Operation When Restoration of Power Occurs while the Control Power (Power Supply to the Control Board) is Maintained

shows an example with this configuration:

- $L2-01 = 4$ [*Kinetic Energy Backup: CPU Power*] is set.
- KEB Ride-Thru is not used.

The drive starts deceleration through KEB operation. The drive decelerates for the time set in parameter $L2-10$, and then measures the DC bus voltage level. When the DC bus voltage is lower than the level set in $L2-11$, the drive uses the KEB Ride-Thru function to continue deceleration. When the DC bus voltage is more than the level set in $L2-11$, usual operation continues. The drive accelerates the motor to the frequency reference value before the power loss, and usual operation continues.

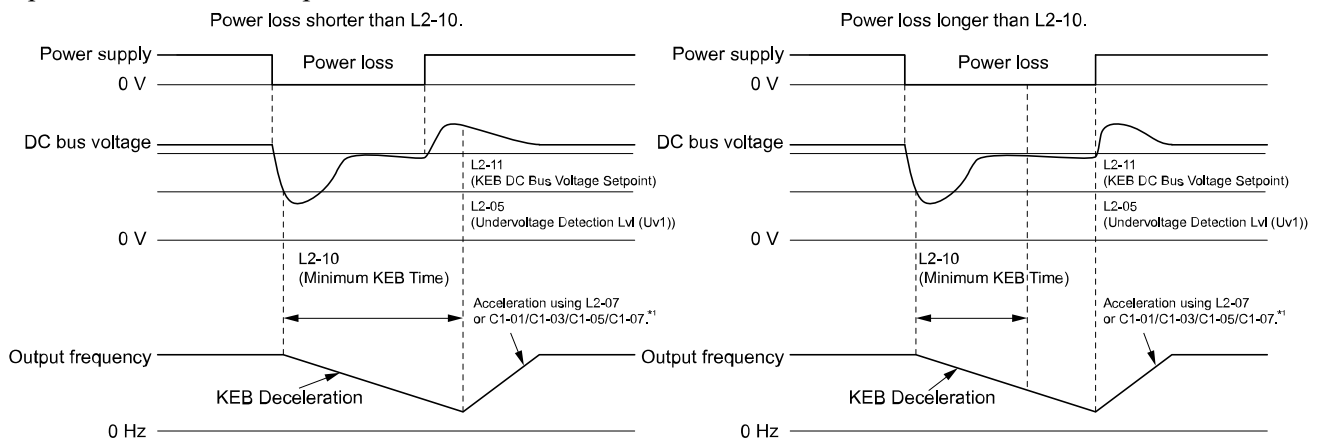

Figure 12.129 Cancel KEB Operation without Using the KEB Ride-Thru if Restoration of Power Occurs while the Control Power (Power Supply to the Control Board) is Maintained

*1 When $L2-07 = 0.00$ s, the drive accelerates again as specified by the applicable *Acceleration Time* [$C1-01$, $C1-03$, $C1-05$, $C1-07$], and usual operation continues.

Use the KEB Ride-Thru to Cancel KEB Operation when Restoration of Power Occurs while the Control Power (Power Supply to the Control Board) is Maintained

shows an example with this configuration:

- $L2-01 = 4$.
- Use *KEB Ride-Thru 1* [$H1-xx = 65, 66$] or *KEB Ride-Thru 2* [$H1-xx = 7A, 7B$].

The drive starts deceleration through KEB operation. When the motor decelerates for the time set in $L2-10$, the drive measures the DC bus voltage and the status of the digital input set for KEB Ride-Thru. When the DC bus voltage is less than the level set in $L2-11$, or if the digital input set to KEB Ride-Thru is active, deceleration continues. When the DC bus voltage is more than the level set in $L2-11$, the drive ends KEB operation. The drive

accelerates the motor to the frequency reference value before the power loss, and usual operation continues. When the KEB Ride-Through continues to be input after the time set in *L2-02* is expired, the drive uses the KEB Ride-Through function to continue to decelerate. When you cancel the KEB Ride-Through, the motor accelerates again, and usual operation continues.

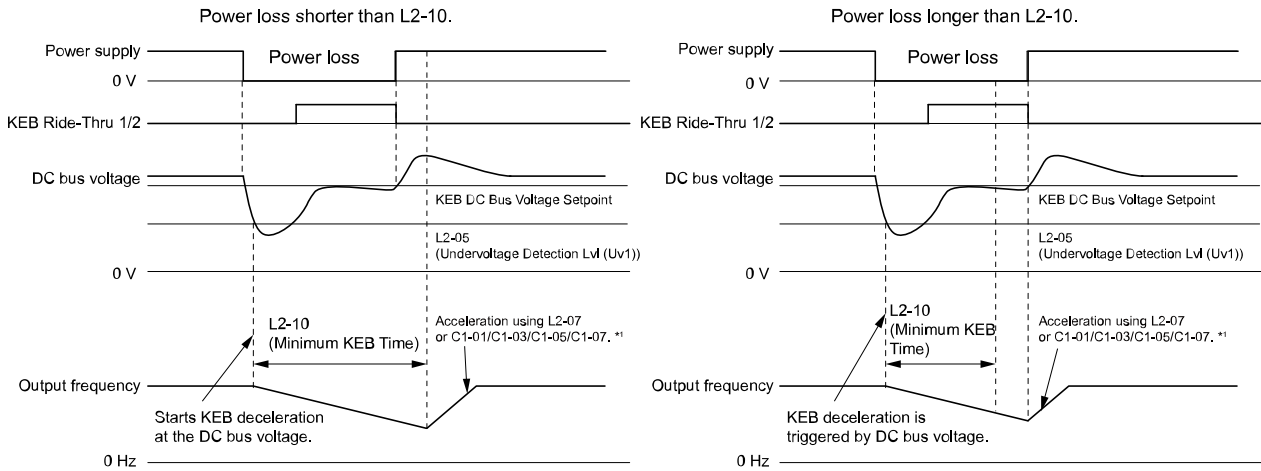

Figure 12.130 Use the KEB Ride-Through to Cancel KEB Operation when Restoration of Power Occurs while the Control Power (Power Supply to the Control Board) is Maintained

*1 When *L2-07* = 0.00 s, the drive accelerates again as specified by the applicable *Acceleration Time* [*C1-01*, *C1-03*, *C1-05*, *C1-07*], and usual operation continues.

KEB Operation when L2-01 = 5 [Kinetic Energy Backup: DecelStop]

The drive starts deceleration through KEB operation. If you do not input the Run command, the motor cannot restart. The drive will continue to decelerate until the motor comes to the minimum output frequency or a complete stop. If you return power during deceleration, the drive continues to decelerate.

KEB Operation Wiring Example

Figure 12.131 shows an example that uses an undervoltage relay to trigger the KEB Ride-Through at power loss. When a power loss occurs, the undervoltage relay triggers *KEB Ride-Through* [*H1-06* = 65, 66, 7A, 7B] at terminal S6.

Note:

- Set the drive to activate the Run command while the KEB function is operating. If you turn off the Run command, the drive will not accelerate back to speed when you return power.
- When you set *L2-29* = 2 [*Kinetic Energy Backup Method* = *System KEB Ride-Through 1*], install a dynamic braking option.

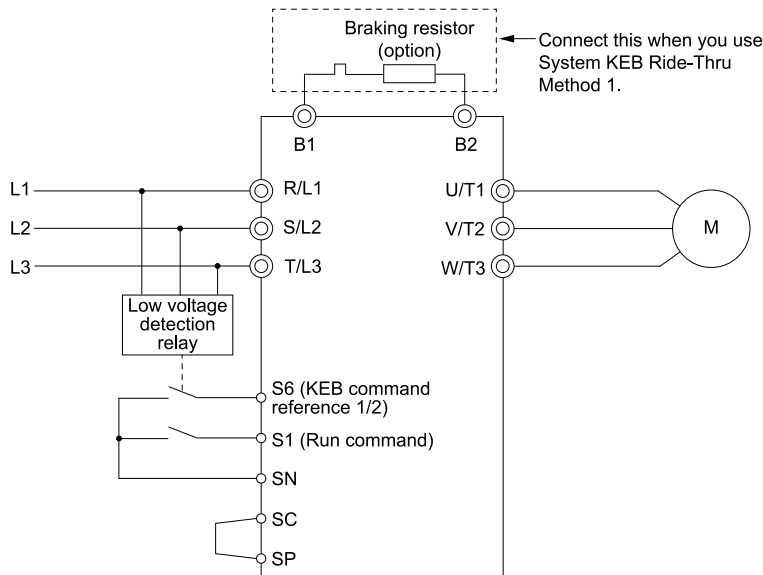

Figure 12.131 KEB Function Wiring Example

Parameters for KEB Ride-Thru

Table 12.74 shows the parameters that adjust the KEB Ride-Thru function. Parameter settings are different for the different KEB methods set in L2-29 [KEB Energy Backup Method].

Table 12.74 Parameters for KEB Ride-Thru

No.	Name	Configuring Settings	L2-29 [Kinetic Energy Backup Method]			
			0	1	2	3
C1-09	Fast Stop Time	<ul style="list-style-type: none"> If <i>ov</i> [Overvoltage] occurs during KEB deceleration, increase the setting value. If <i>Uv1</i> [DC Bus Undervoltage] occurs during KEB deceleration, decrease the setting value. 	x *1	-	-	-
C2-03	S-Curve Time @ Start of Decel	<ul style="list-style-type: none"> If <i>ov</i> occurs immediately after you start KEB deceleration, increase the setting value. If <i>Uv1</i> occurs immediately after you start operation, decrease the setting value. 	x	-	x	x
L2-05	Undervoltage Detection Lvl (Uv1)	If <i>Uv1</i> occurs immediately after you start KEB deceleration, increase the setting value to detect power loss more quickly.	x	x	x	x
L2-06	Kinetic Energy Backup Decel Time	<ul style="list-style-type: none"> Does KEB Tuning. If <i>ov</i> or <i>Uv1</i> occur during KEB deceleration after the KEB Tuning, set L2-06 in these conditions: <ul style="list-style-type: none"> If <i>ov</i> occurs, increase the setting value If <i>Uv1</i> occurs, decrease the setting value. 	-	-	x *2	x *2
L2-07	Kinetic Energy Backup Accel Time	Sets the acceleration time to return to the frequency reference value before a power loss, after you cancel the KEB operation. When L2-07 = 0, the drive uses the standard acceleration times set in C1-01, C1-03, C1-05, and C1-07 [Acceleration Time].	x	x	x	x
L2-08	Frequency Gain at KEB Start	<ul style="list-style-type: none"> If <i>ov</i> occurs immediately after you start operation, decrease the setting value. If <i>Uv1</i> occurs immediately after you start KEB deceleration, increase the setting value. 	x	-	x	x
L2-10	Minimum KEB Time	<ul style="list-style-type: none"> With KEB Ride-Thru There is <i>Uv1</i> because you set a digital input for KEB Ride-Thru and the device that controls the input operated too slowly after power loss. Without KEB Ride-Thru If the DC bus voltage overshoots immediately after KEB Ride-Thru starts, increase L2-10 to longer than the overshoot. 	x	x	x	x
L2-11	KEB DC Bus Voltage Setpoint	<ul style="list-style-type: none"> Single Drive KEB Ride-Thru 2 Set to approximately 1.22 x input voltage. Single Drive KEB Ride-Thru 1, System KEB Ride-Thru 1, or System KEB Ride-Thru 2 Set to approximately 1.4 x input voltage. 	x	x	x	x
L3-20	DC Bus Voltage Adjustment Gain	<ul style="list-style-type: none"> If <i>ov</i> or <i>Uv1</i> occurs at the start of deceleration when you use KEB operation, increase this value in 0.1-unit increments. If there is torque ripple during deceleration when you use KEB Ride-Thru, decrease the value. 	-	x	-	-
L3-21	OVSUPPRESSION Accel/Decel P Gain	If there is large speed or current ripple, decrease the value in 0.05 unit increments. Note: If the setting value is too low, then the drive will have unsatisfactory DC bus voltage control response. The drive can detect <i>ov</i> or <i>Uv1</i> .	-	x	-	-
L3-24	Motor Accel Time @ Rated Torque	Set the motor acceleration time to the maximum frequency at the motor rated torque.	-	x	-	-
L3-25	Load Inertia Ratio	Sets the ratio between motor inertia and machine inertia.	-	x *3	-	-

*1 When L2-29 = 0 [KEB Energy Backup Method = Single Drive KEB Ride-Thru 1] and you do KEB Auto-Tuning, the drive will automatically set C1-09. If you must not change the Fast Stop time, do not do KEB Tuning.

*2 If you do KEB Tuning when L2-29 = 1, 2, or 3 [KEB Energy Backup Method = Single Drive KEB Ride-Thru 2, System KEB Ride-Thru 1 or System KEB Ride-Thru 2], the drive will automatically set L2-06 [KEB Decel Time].

*3 The drive sets this value automatically when KEB Tuning completes correctly.

L2-01: Power Loss Ride Through Select

No. (Hex.)	Name	Description	Default (Range)
L2-01 (0485)	Power Loss Ride Through Select	 Sets the drive operation after a momentary power loss.	0 (0 - 5)

The drive detects momentary power loss when the drive DC bus voltage is less than the value set in L2-05 [Undervoltage Detection Lvl (Uv1)].

0 : Disable

A momentary power loss triggers *Uv1* [DC Bus Undervoltage].

If you do not restore power in 15 ms, a *Uv1* is triggered and the drive shuts off the output. The motor coasts to stop.

1 : Enabled

This setting will enable for the time set in *L2-02 [Power Loss Ride Through Time]* or until the CPU is inactive. When the CPU is inactive, *b1-17 [Run Command at Power Up]* sets operation at power up.

When power returns in the time set in *L2-02*, the drive will restart. If power does not return in the time set in *L2-02*, the drive will detect *UvI*.

The drive momentarily turns OFF its output after a power loss. If the power returns in the time set to *L2-02*, the drive will do Speed Search and try to continue operation.

If the DC bus voltage is less than or equal to the *UvI* detection level for the time set in *L2-02*, the drive will detect *UvI* and output a fault signal.

Note:

- This setting will enable for the time set in *L2-02 [Power Loss Ride Through Time]* or until the CPU is inactive. When the CPU is inactive, *b1-17 [Run Command at Power Up]* sets operation at power up.
- The necessary time for the drive to restart after power returns is different for different drive capacities.
- The upper limit of the possible momentary power loss Ride-Thru time is different for different drive models.

2 : Enabled while CPU Power Active

This setting will enable for the time set in *L2-02 [Power Loss Ride Through Time]* or until the CPU is inactive. When the CPU is inactive, *b1-17 [Run Command at Power Up]* sets operation at power up.

When power returns and the drive control circuit has power, the drive will restart. This will not trigger *UvI*.

When there is a momentary power loss, the drive output will turn OFF. If the power returns and the drive control circuit has power, the drive will do Speed Search and try to continue operation. This will not trigger a *UvI*. This function lets the drive lose power for longer than when *L2-01 = 1*.

Note:

This setting will enable for the time set in *L2-02 [Power Loss Ride Through Time]* or until the CPU is inactive. When the CPU is inactive, *b1-17 [Run Command at Power Up]* sets operation at power up.

3 : Kinetic Energy Backup: L2-02

If power does not return in the time set in *L2-02*, the drive will detect *UvI*.

If the drive detects momentary power loss, the drive will use regenerative energy from the motor and ramp to stop. When you return power in the time set in *L2-02*, the drive will accelerate to the frequency reference value that the drive used before the power loss. If you do not return power in the time set to *L2-02*, the drive will detect *UvI* and the drive output will turn OFF. *L2-29 [Kinetic Energy Backup Method]* sets the type of KEB operation.

4 : Kinetic Energy Backup: CPU Power

When power returns and the drive control circuit has power, the drive will restart.

The drive decelerates using regenerative energy from the motor until the power returns and then restarts when a momentary power loss is detected. When power is restored during deceleration, the drive accelerates the motor again to the frequency reference value used before the power loss. If the motor comes to a stop before the power returns, the drive loses control power and the drive output shuts off. A *UvI* is not triggered when power is restored while power to the CPU in the drive is maintained. *L2-29* sets the type of KEB operation.

5 : Kinetic Energy Backup: DecelStop

When power returns, the drive will continue to decelerate until the motor fully stops.

If the drive detects momentary power loss, the drive will use regenerative energy from the motor and ramp to stop. When you return power to the drive, the drive will continue to decelerate until the motor comes to a full stop. After you return power, the drive will ramp to stop in the set deceleration time. *L2-29* sets the type of KEB operation.

Note:

When you set *L2-01*, make sure that you know these items:

- You can use a Momentary Power Loss Unit on models 2004 to 2056 and 4002 to 4031 for a longer momentary power loss ride through time. A Momentary Power Loss Unit makes it possible to continue operation of the drive after a maximum of 2 seconds of power loss.
- When you set *L2-01 = 1 to 4*, keep the magnetic contactor on the drive input side ON and keep the control signal while the drive does KEB operation.
- When *L2-01 = 1 to 5*, *Uv* [DC Bus Undervoltage] will flash on the keypad while the drive is attempting to recover from a momentary power loss. The drive will not output a fault signal at this time.
- When you use a magnetic contactor between the motor and the drive, keep the magnetic contactor closed while the drive does KEB operation or tries to restart with Speed Search.
- Keep the Run command active during KEB operation. The drive cannot accelerate back to the frequency reference when the power returns.
- When *L2-01 = 3 to 5*, if the control power supply voltage is less than the CPU operation level during KEB Ride-Thru, it will trigger *Uv1*.
- When the CPU is inactive, *b1-17* [Run Command at Power Up] sets operation at power up.

■ L2-02: Power Loss Ride Through Time

No. (Hex.)	Name	Description	Default (Range)
L2-02 (0486)	Power Loss Ride Through Time	V/f CL-V/f OLV CLV AOLV OLV/PM AOLV/PM CLV/PM EZOLV Sets the length of time that the drive will wait before it tries to restart if the DC bus voltage is less than <i>L2-05</i> [Undervoltage Detection Lvl (<i>Uv1</i>)] after a momentary power loss.	Determined by o2-04, C6-01 (0.0 - 25.5 s)

This function is applicable when *L2-01 = 1, 3* [Power Loss Ride Through Select = Enabled, Kinetic Energy Backup: *L2-02*].

After a power loss, if these conditions are satisfied, the drive detects *Uv1* [DC Bus Undervoltage], shuts off the output, and the motor coasts to stop:

- After the DC bus voltage decreases less than the level of *L2-05* [Undervoltage Detection Lvl (*Uv1*)], the time set in *L2-02* is expired.
- The drive does not detect a *Uv2* [Control Power Undervoltage].

Depending on use conditions, if the time set in *L2-02* is long, the drive may detect *Uv2* before *Uv1*. If this is a problem, decrease the time set in *L2-02* to prevent *Uv2*.

Note:

- The length of time that the drive can recover after a power loss changes when drive capacity changes.
- The upper limit of the possible momentary power loss Ride-Thru time changes when drive capacity changes.

■ L2-03: Minimum Baseblock Time

No. (Hex.)	Name	Description	Default (Range)
L2-03 (0487)	Minimum Baseblock Time	V/f CL-V/f OLV CLV AOLV OLV/PM AOLV/PM CLV/PM EZOLV Sets the minimum time to continue the drive output block (baseblock) after a baseblock.	Determined by o2-04, C6-01 (0.1 - 5.0 s)

Sets the length of time that the drive will wait for the residual voltage in the motor to dissipate in estimation to the secondary circuit time constant of the motor. If *oC* [Overcurrent] or *ov* [DC Bus Overvoltage] occur at the start of Speed Search, after power returns, or during DC Injection Braking, increase this setting.

■ L2-04: Powerloss V/f Recovery Ramp Time

No. (Hex.)	Name	Description	Default (Range)
L2-04 (0488)	Powerloss V/f Recovery Ramp Time	V/f CL-V/f OLV CLV AOLV OLV/PM AOLV/PM CLV/PM EZOLV Sets the time for the drive output voltage to go back to correct voltage after completing speed searches.	Determined by o2-04, C6-01 (0.0 - 5.0 s)

Sets the time for voltage to recover from 0 V to the value set in *E1-05* [Maximum Output Voltage].

■ L2-05: Undervoltage Detection Lvl (*Uv1*)

No. (Hex.)	Name	Description	Default (Range)
L2-05 (0489)	Undervoltage Detection Lvl (<i>Uv1</i>)	V/f CL-V/f OLV CLV AOLV OLV/PM AOLV/PM CLV/PM EZOLV Sets the voltage at which a <i>Uv1</i> [DC Bus Undervoltage] fault is triggered or at which the KEB function is activated. Usually it is not necessary to change this setting.	Determined by o2-04 and E1-01 (200 V Class: 150 - 210 V, 400 V Class: 300 - 420 V)

NOTICE: Damage to Equipment. When you set this parameter to a value lower than the default, you must install an AC reactor on the input side of the power supply. If you do not install an AC reactor, it will cause damage to the drive circuitry.

Note:

If the low voltage detection level is near the lower limit value of L2-05, the drive will detect *Uv1* during KEB Ride-Thru operation. Do not set the value too low when you use the KEB Ride-Thru function.

■ **L2-06: Kinetic Energy Backup Decel Time**

No. (Hex.)	Name	Description	Default (Range)
L2-06 (048A) Expert	Kinetic Energy Backup Decel Time	V/f CL-V/f OLV CLV AOLV OLV/PM AOLV/PM CLV/PM EZOLV Sets the deceleration time during KEB operation used to decrease the maximum output frequency to 0.	0.0 s (0.0 - 6000.0 s)

Set L2-29 = 2 or 3 [Kinetic Energy Backup Method = System KEB Ride-Thru 1 or System KEB Ride-Thru 2] to enable this function. When L2-29 = 1, 2, 3 [Kinetic Energy Backup Method = Single Drive KEB Ride-Thru 2, System KEB Ride-Thru 1, System KEB Ride-Thru 2] and you do KEB Auto-Tuning, the drive will automatically set this value.

Sets the deceleration time necessary to decelerate from the frequency reference to 0 Hz when the drive detects a momentary power loss. If a *Uv1* [DC Bus Undervoltage] fault occurs during KEB operation, decrease the deceleration time. If an *ov* [Overvoltage] fault occurs, increase the deceleration time.

- L2-06 = 0

The drive automatically decreases C1-09 [Fast Stop Time] to the base value to keep the DC bus voltage above the low voltage detection level. The drive ignores L2-02 [Momentary Power Loss Ride-Thru Time] in this condition.

- L2-06 ≠ 0

As shown in Figure 12.132, the frequency reference decelerates to the KEB frequency level as specified by the deceleration rate set in L2-06 and then returns to the initial frequency reference as specified by C1-01 [Acceleration Time 1]. The drive uses the setting value of the KEB frequency rate as shown in the this formula to set the KEB frequency level:

$$\text{KEB frequency level} = \text{Output frequency before power loss} \times (1 - (L2-02) / (L2-06))$$

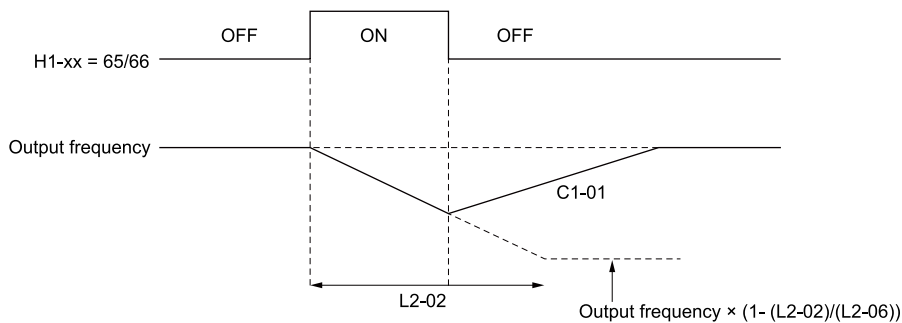

Figure 12.132 Kinetic Energy Backup Decel Time

■ **L2-07: Kinetic Energy Backup Accel Time**

No. (Hex.)	Name	Description	Default (Range)
L2-07 (048B) Expert	Kinetic Energy Backup Accel Time	V/f CL-V/f OLV CLV AOLV OLV/PM AOLV/PM CLV/PM EZOLV Sets the acceleration time to return the frequency to the frequency reference before a power loss after canceling KEB operation.	0.0 s (0.0 - 6000.0 s)

Set this parameter to 0.0 to disable the function. The drive uses the acceleration time in C1-01, C1-03, C1-05, and C1-07 to accelerate again after KEB operation completes.

■ **L2-08: Frequency Gain at KEB Start**

No. (Hex.)	Name	Description	Default (Range)
L2-08 (048C) Expert	Frequency Gain at KEB Start	V/f CL-V/f OLV CLV AOLV OLV/PM AOLV/PM CLV/PM EZOLV Sets the quantity of output frequency reduction used when KEB operation starts as a percentage of the motor rated slip before starting KEB operation.	100% (0 - 300%)

Decreases the output frequency in steps to quickly set the motor to a regenerative condition. Use this formula to calculate the value:

Output frequency reduction = Motor rated slip before KEB operation $\times (L2-08/100) \times 2$

■ L2-09: KEB Minimum Frequency Level

No. (Hex.)	Name	Description	Default (Range)
L2-09 (048D) Expert	KEB Minimum Frequency Level	V/f CL-V/f OLV CLV AOLV OLV/PM AOLV/PM CLV/PM EZOLV Sets the quantity of output frequency reduction used as a percentage of E2-02 [Motor Rated Slip] when KEB operation starts.	20% (0 - 100%)

These conditions set the quantity of decrease:

- Motor rated slip $\times (L2-09/100)$
- The larger value between the value calculated with L2-08 and the value calculated with L2-09

■ L2-10: Minimum KEB Time

No. (Hex.)	Name	Description	Default (Range)
L2-10 (048E) Expert	Minimum KEB Time	V/f CL-V/f OLV CLV AOLV OLV/PM AOLV/PM CLV/PM EZOLV Sets the minimum length of time to operate the KEB after the drive detects a momentary power loss.	50 ms (0 - 25500 ms)

When you return power while KEB is operating, the drive continues KEB operation until the time set in L2-10 is expired. When the DC bus voltage is less than the level of L2-05 [Undervoltage Detection Lvl (Uv1)] in one of these conditions, KEB operation continues until the time set in L2-10 is expired:

- L2-01 = 3 [Power Loss Ride Through Select = Kinetic Energy Backup: L2-02]
- L2-01 = 4 [Kinetic Energy Backup: CPU Power]
- L2-01 = 5 [Kinetic Energy Backup: DecelStop]
- KEB Ride-Thru 1/2 [H1-xx = 65, 66, 7A, or 7B] is input into the drive.

When you input KEB Ride-Thru, KEB operation continues after the time set in L2-10 is expired. When you cancel KEB Ride-Thru, the motor accelerates again. When you do not input KEB Ride-Thru during the time set in L2-10, the drive accelerates to the frequency reference that the drive had before power loss in the applicable acceleration time.

When L2-01 = 3, 4, or 5, and the DC bus voltage is a minimum of the value of L2-11 [KEB DC Bus Voltage Setpoint], the drive accelerates again after the time set in L2-10 is expired. When the DC bus voltage is less than the L2-11 value, KEB operation continues after the time set in L2-10 is expired.

Note:

- When L2-01 = 0, 1, or 2 [Disabled, Enabled for L2-02 Time, or Enabled while CPU Power Active], increase the value of L2-10. Set L2-10 to cancel KEB operation if the KEB Ride-Thru is not input.
- Setting L2-10 to 0 ms disables the function of L2-10.

■ L2-11: KEB DC Bus Voltage Setpoint

No. (Hex.)	Name	Description	Default (Range)
L2-11 (0461) Expert	KEB DC Bus Voltage Setpoint	V/f CL-V/f OLV CLV AOLV OLV/PM AOLV/PM CLV/PM EZOLV Sets the target value that controls the DC bus voltage to a constant level in Single Drive KEB Ride-Thru 2. Sets the DC bus voltage level that completes the KEB operation for all other KEB methods.	Determined by E1-01 (Determined by E1-01)

■ L2-29: Kinetic Energy Backup Method

No. (Hex.)	Name	Description	Default (Range)
L2-29 (0475) Expert	Kinetic Energy Backup Method	V/f CL-V/f OLV CLV AOLV OLV/PM AOLV/PM CLV/PM EZOLV Sets the KEB function operation mode.	0 (0 - 3)

Set L2-01 = 3, 4, or 5 [Power Loss Ride Through Select = Kinetic Energy Backup: L2-02, Kinetic Energy Backup: CPU Power, or Kinetic Energy Backup: DecelStop] or KEB Ride-Thru 1/2 [H1-xx = 65, 66, 7A, or 7B], to enable the KEB function.

0 : Single Drive KEB Ride-Thru 1

The drive monitors the DC bus voltage and uses regenerative energy from the motor to hold the DC bus voltage at the level set in L2-11 [KEB DC Bus Voltage Setpoint].

The KEB operation continues and the deceleration rate changes as specified by *CI-09 [Fast Stop Time]*.

Note:

- If the drive detects *Uv1 [DC Bus Undervoltage]* during KEB operation, decrease the value of *CI-09*.
- If the drive detects *ov [Overvoltage]* during KEB operation, increase the value of *CI-09*.

1 : Single Drive KEB Ride-Thru 2

The drive does KEB operation and automatically calculates the deceleration rate to make sure that the main circuit electrical energy and main current voltage from motor regenerative energy is equal to *L2-11*.

2 : System KEB Ride-Thru 1

The drive does not monitor the DC bus voltage and decelerates as specified by the KEB deceleration time set in *L2-06*.

Use *L2-06* to set the time necessary to decelerate from the current frequency reference to 0 Hz. More than one drive can decelerate and keep a constant speed ratio between drives.

Note:

If you keep constant deceleration rates for more than one drive, it can trigger *ov* faults. Use the dynamic braking option with System KEB Ride-Thru 1.

3 : System KEB Ride-Thru 2

The drive uses the KEB deceleration time set in *L2-06* to decelerate and it also monitors the DC bus voltage.

If the voltage level increases, the drive momentarily holds the frequency to prevent an *ov* before it continues to decelerate.

Note:

When you cannot use a dynamic braking option, use System KEB Ride-Thru.

■ L2-30: KEB Zero Speed Operation

No. (Hex.)	Name	Description	Default (Range)
L2-30 (045E) Expert	KEB Zero Speed Operation	<div style="display: flex; justify-content: space-between; font-size: small;"> V/f CL-V/f OLV CLV AOLV OLV/PM AOLV/PM CLV/PM EZOLV </div> <p>Sets the operation when the output frequency decreases below the zero level (DC braking injection starting frequency) during KEB deceleration when <i>L2-01 = 3 to 5 [Power Loss Ride Through Select = Kinetic Energy Backup: L2-02, Kinetic Energy Backup: CPU Power, or Kinetic Energy Backup: DecelStop]</i>.</p>	0 (0, 1)

0 : Baseblock

1 : DC/SC Braking

Does DC injection braking and short circuit braking as specified by *b2-04 [DC Inject Braking Time at Stop]* and *b2-13 [Short Circuit Brake Time @ Stop]*.

■ L2-31: KEB Start Voltage Offset Level

No. (Hex.)	Name	Description	Default (Range)
L2-31 (045D) Expert	KEB Start Voltage Offset Level	<div style="display: flex; justify-content: space-between; font-size: small;"> V/f CL-V/f OLV CLV AOLV OLV/PM AOLV/PM CLV/PM EZOLV </div> <p>Sets the KEB start voltage offset.</p>	Determined by A1-02 (200 V Class: 0 - 100 V, 400 V Class: 0 - 200 V)

The drive uses this formula to calculate the KEB start voltage:

$$\text{KEB start voltage} = L2-05 [\text{Undervoltage Detect Level (Uv1)}] + L2-31$$

◆ L3: Stall Prevention

L3 parameters set the Stall Prevention function and overvoltage suppression function.

■ Stall Prevention

If the load is too heavy or the acceleration and deceleration times are too short, the motor can slip too much because it cannot work at the same rate as the frequency reference. If the motor stalls during acceleration, current increases as the slip increases to cause an *oC [Overcurrent]*, *oL2 [Drive Overload]*, or *oL1 [Motor Overload]* and the drive will stop. If the motor stalls during deceleration, too much regenerative power will flow back into the DC bus capacitors, and cause the drive to detect an *ov [Overvoltage]* fault and stop.

The stall prevention function will let the motor get to the set speed without stalling and it is not necessary for you to change the acceleration or deceleration time settings. You can set a separate stall prevention functions for acceleration, operating at constant speeds, and deceleration.

■ Overvoltage Suppression Function

Decreases the regenerative torque limit and increases the output frequency when the DC bus voltage increases to prevent *ov*. This function can drive loads with cyclic regenerative operation, for example punch presses or other applications with repeated crank movements. When you use this function, set $L3-11 = 1$ [*Overvoltage Suppression Select = Enabled*].

The drive adjusts the regenerative torque limit and the output frequency during overvoltage suppression to make sure that the DC bus voltage is not more than the level set in $L3-17$ [*DC Bus Regulation Level*].

Set these parameters as necessary when you use the overvoltage suppression function:

- $L3-20$ [*DC Bus Voltage Adjustment Gain*]
- $L3-21$ [*OVSuppression Accel/Decel P Gain*]
- $L3-24$ [*Motor Accel Time @ Rated Torque*]
- $L3-25$ [*Load Inertia Ratio*]

Note:

- When overvoltage suppression is triggered, the motor speed is more than the frequency reference. Do not use overvoltage suppression for applications where the frequency reference and the motor speed must align.
- When you use a braking resistor, set $L3-11 = 0$ [*Disabled*].
- The overvoltage suppression function is enabled only when you operate immediately below the maximum frequency. Overvoltage suppression does not increase the output frequency to more than the maximum frequency. Make sure that the motor and machine specifications are correct for the application, then increase the maximum frequency.
- If there is a sudden increase to a regenerative load, *ov* can occur.

■ L3-01: Stall Prevention during Accel

No. (Hex.)	Name	Description	Default (Range)
L3-01 (048F)	Stall Prevention during Accel	<div style="display: flex; gap: 5px;"> V/f CL-V/f OLV CLV AOLV OLV/PM AOLV/PM CLV/PM EZOLV </div> Sets the method of the Stall Prevention During Acceleration.	1 (0 - 3)

Note:

When $A1-02 = 5$ [*Control Method Selection = OLV/PM*], the setting range is 0 and 1.

Stall prevention during acceleration prevents the stalling and stopping of motors when the drive detects *oC* [*Overcurrent*], *oL2* [*Drive Overloaded*], or *oL1* [*Motor Overload*] when you apply a large load during acceleration or when you set sudden acceleration times related to load inertia.

0 : Disable

The Stall Prevention function does not operate during acceleration, and acceleration occurs for the set acceleration time. If the acceleration time is too short, the motor does not fully accelerate during the set time, which causes the drive to detect *oL1* or *oL2* and the motor to stop.

1 : Enabled

Enables the Stall Prevention During Acceleration function. Operation is different for different control methods.

• V/f Control, Open Loop Vector Control, or EZ Open Loop Vector Control

When the output current is more than the value set in $L3-02$ [*Stall Prevent Level during Accel*], the drive stops acceleration. The drive stops deceleration when the output current is less than $L3-02 - 15\%$. The Stall Prevention function level automatically decreases for constant output ranges.

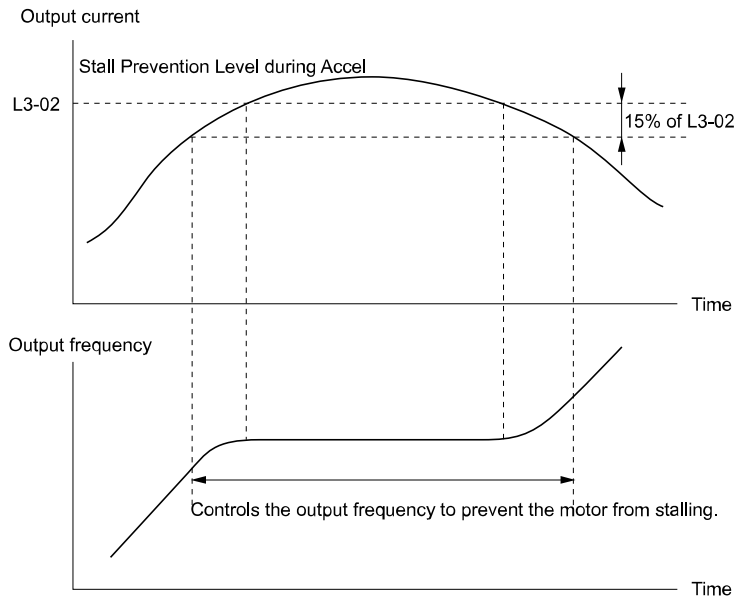

Figure 12.133 Stall Prevention During Acceleration when Using Induction Motors

• **Open Loop Vector Control for PM**

When the output current is more than *L3-02*, the drive stops acceleration. When the time set in *L3-27* [Stall Prevention Detection Time] is expired and the output current = *L3-02*, the drive will start deceleration as specified by the value set in *L3-22* [PM Stall Prevention Decel Time]. The drive starts acceleration again when the output current is less than *L3-02* - 15%. When the time set in *L3-27* is expired, the drive starts acceleration again.

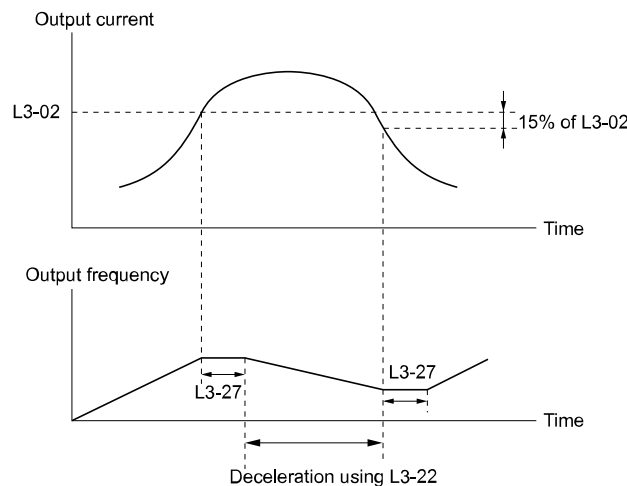

Figure 12.134 Stall Prevention During Acceleration Function in OLV/PM

2 : Intelligent (Ignore Accel Ramp)

The drive ignores the acceleration time setting and the drive starts to accelerate in the minimum length of time. The drive automatically adjusts the acceleration rate to make sure that the output current is not more than *L3-02*.

3 : Current Limit Acceleration

This function uses the *L3-02* value to limit the output current and automatically adjust the acceleration rate. When the load (output current) increases to more than the current limit level during acceleration, the drive automatically adjusts the acceleration rate.

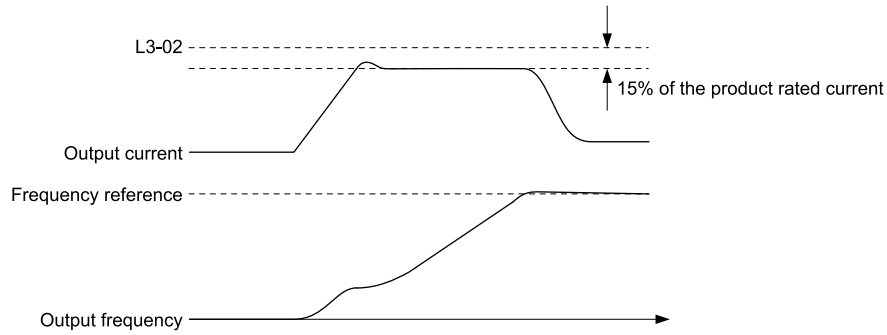

Figure 12.135 Current Limit Acceleration

■ L3-02: Stall Prevent Level during Accel

No. (Hex.)	Name	Description	Default (Range)
L3-02 (0490)	Stall Prevent Level during Accel	<input type="checkbox"/> V/f <input type="checkbox"/> CL-V/f <input type="checkbox"/> OLV <input type="checkbox"/> CLV <input type="checkbox"/> AOLV <input type="checkbox"/> OLVP/PM <input type="checkbox"/> AOLV/PM <input type="checkbox"/> CLV/PM <input type="checkbox"/> EZOLV	Determined by C6-01 and L8-38 (0 - 150%)

Note:

- If you use a motor that is small compared to the drive and the motor stalls, decrease the setting value.
- When you operate the motor in the constant power range, set L3-03 [Stall Prevent Limit during Accel].
- The upper limit of the setting range changes when C6-01 [Normal / Heavy Duty Selection] changes.
 - 150% when C6-01 = 0 [Heavy Duty Rating].
 - 110% when C6-01 = 1 [Normal Duty Rating].

■ L3-03: Stall Prevent Limit during Accel

No. (Hex.)	Name	Description	Default (Range)
L3-03 (0491)	Stall Prevent Limit during Accel	<input type="checkbox"/> V/f <input type="checkbox"/> CL-V/f <input type="checkbox"/> OLV <input type="checkbox"/> CLV <input type="checkbox"/> AOLV <input type="checkbox"/> OLVP/PM <input type="checkbox"/> AOLV/PM <input type="checkbox"/> CLV/PM <input type="checkbox"/> EZOLV	50% (0 - 100%)

The stall prevention level set in L3-02 [Stall Prevent Level during Accel] is automatically reduced when the motor is running within the constant output range. Parameter L3-03 is the limit value used to prevent the stall prevention level during constant output ranges to fall below the minimum required level.

Note:

The function to automatically reduce the stall prevention level does not operate when L3-01 = 3 [Stall Prevention during Accel = Current Limit Method].

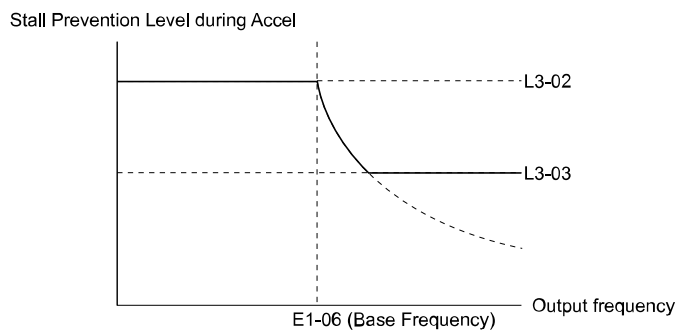

Figure 12.136 Stall Prevent Level during Accel/Limit

■ L3-04: Stall Prevention during Decel

No. (Hex.)	Name	Description	Default (Range)
L3-04 (0492)	Stall Prevention during Decel	<input type="checkbox"/> V/f <input type="checkbox"/> CL-V/f <input type="checkbox"/> OLV <input type="checkbox"/> CLV <input type="checkbox"/> AOLV <input type="checkbox"/> OLVP/PM <input type="checkbox"/> AOLV/PM <input type="checkbox"/> CLV/PM <input type="checkbox"/> EZOLV	1 (Determined by A1-02)

Note:

1. To connect a dynamic braking option (braking resistor or braking resistor unit) to the drive, set this parameter to 0 or 3. Parameter values 1, 2, 4, and 5 will enable Stall Prevention function during deceleration, and the dynamic braking option will not function.
2. The setting range changes when the A1-02 [Control Method Selection] value changes:
 - When A1-02 = 5 [OLV/PM], the setting range is 0 to 2.
 - When A1-02 = 6, 7, 8 [AOLV/PM, CLV/PM, EZOLV], the setting range is 0, 1.

Stall Prevention during deceleration controls the deceleration as specified by the DC bus voltage and does not let high inertia or fast deceleration cause *ov* [Overvoltage] faults.

0 : Disable

The drive decelerates as specified by the deceleration time. If the deceleration time is too short, the drive can detect an *ov* fault.

Note:

If an *ov* fault occurs, connect a dynamic braking option to the drive. If an *ov* fault occurs after you connect a dynamic braking option and A1-02 = 0 or 2 [Control Method Selection = V/f or CLV] and L3-04 = 0, set L3-04 = 3.

1 : General Purpose

The drive decelerates as specified by the deceleration time. When the DC bus voltage is more than the Stall Prevention level, the drive stops deceleration until the DC bus voltage is less than the Stall Prevention Level. The drive then starts to decelerate at the set deceleration time. Frequent use of Stall Prevention will help prevent *ov* faults when the deceleration time is shorter than the drive can usually accept.

Note:

The Decel Stall Prevention function will increase the deceleration time to stop and the deceleration time will be longer than the setting. This function is not applicable for conveyor applications because the precision of the stop position is very important. As an alternative, use a dynamic braking option in these applications.

The input voltage setting of E1-01 [Input AC Supply Voltage] sets the DC bus voltage level for Stall Prevention.

Table 12.75 Stall Prevention Level during Deceleration

Drive Input Voltage	Stall Prevention Level during Deceleration
200 V Class	377 V
400 V Class	754 V

Figure 12.137 shows the Stall Prevention during deceleration function.

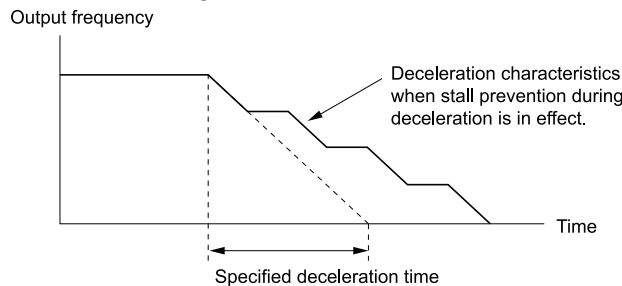

Figure 12.137 Stall Prevention Operation during Deceleration

2 : Intelligent (Ignore Accel Ramp)

The drive adjusts the deceleration rate to keep the DC bus voltage at the L3-17 [DC Bus Regulation Level] level. This makes the shortest possible deceleration time and will not let the motor stall. The drive ignores the selected deceleration time and the possible deceleration time cannot be less than 1/10 of the set deceleration time.

This function uses these parameters to adjust the deceleration rate:

- L3-20 [DC Bus Voltage Adjustment Gain]
- L3-21 [OVSuppression Accel/Decel P Gain]
- L3-24 [Motor Accel Time @ Rated Torque]
- L3-25 [Load Inertia Ratio]

Note:

The deceleration time is not constant. For applications where the precision of the stop position is very important, use a dynamic braking option and set L3-04 = 0. If an *ov* occurs, set L3-04 = 3.

3 : General Purpose w/ DB resistor

A braking resistor is necessary for this setting. The braking resistor and the drive work together for the Stall Prevention during deceleration function.

4 : Overexcitation/High Flux 1

Enables Overexcitation/High Flux and enables a shorter deceleration time than when $L3-04 = 0$.

Note:

- If the overexcitation time is long and you decelerate frequently, the drive can detect $oL1$ [Motor Overload] faults. If the drive detects $oL1$, decrease the deceleration time or install a braking resistor to the drive.
- The deceleration time during Overexcitation Deceleration changes when the motor characteristics and machine inertia change. Adjust the $n3-13$ [OverexcitationBraking (OEB) Gain] and $n3-23$ [Overexcitation Braking Operation] levels. Refer to “n3: HighSlip/OverexciteBraking” for more information about the overexcitation function.

5 : Overexcitation/High Flux 2

Enables Overexcitation/High Flux 2. This function decreases the possible deceleration time more than *Overexcitation/High Flux*.

The drive decreases motor speed and tries to keep the DC bus voltage at the $L3-17$ level.

If the drive detects $oL1$, decrease the values set in $n3-13$ and $n3-21$. If the drive detects ov , increase the values set in $C1-02$, $C1-04$, $C1-06$, and $C1-08$ [Deceleration Times].

Note:

- During Overexcitation/High Flux 2, the drive disables Hunting Prevention in V/f Control and also disables Speed Control that uses torque limit in OLV Control.
- Refer to “n3: HighSlip/OverexciteBraking” for more information about the overexcitation function.

■ L3-05: Stall Prevention during RUN

No. (Hex.)	Name	Description	Default (Range)
L3-05 (0493)	Stall Prevention during RUN	 Sets the function to enable and disable Stall Prevention During Run.	Determined by A1-02 (0 - Determined by A1-02)

Stall Prevention function during run prevents the motor from stalling by automatically reducing the speed when an $oL1$ [Motor Overload] occurs while the motor is running at constant speed.

Note:

1. An output frequency lower than 6 Hz will disable Stall Prevention during Run. The $L3-05$ and $L3-06$ [Stall Prevent Level during Run] settings do not have an effect.
2. The setting range changes when $A1-02$ [Control Method] changes:
 - $A1-02 = 0, 1, 5$ [V/f, CL-V/f, OLV/PM]: 0 to 2
 - $A1-02 = 8$ [EZOLV]: 0, 3

0 : Disabled

The drive runs at the set frequency reference. A heavy load can cause the drive to detect oC [Overcurrent] or $oL1$ and stall the motor.

1 : Deceleration Time 1 (C1-02)

The drive will decelerate for the time set in $C1-02$ [Deceleration Time 1] when the current is more than the Stall Prevention level set in $L3-06$. When the current level is less than the “ $L3-06$ setting value - 2%” for 100 ms, the drive accelerates again for the acceleration time applicable at that time until it reaches the set frequency.

2 : Deceleration Time 2 (C1-04)

This setting functions the same as *Setting 1* [Deceleration Time 1 (C1-02)]. When the Stall Prevention function is enabled, the drive decelerates with the value set in $C1-04$ [Deceleration Time 2].

3 : Intelligent (Ignore Decel Ramp)

Available when $A1-02 = 8$ [EZOLV]. The drive operates with the largest possible output and prevents motor stalling.

■ L3-06: Stall Prevent Level during Run

No. (Hex.)	Name	Description	Default (Range)
L3-06 (0494)	Stall Prevent Level during Run	 Sets the output current level to enable the Stall Prevention function during operation as a percentage of the drive rated output current.	Determined by C6-01 and L8-38 (5 - 150%)

Note:

- This parameter is applicable when $L3-05 = 1, 2$ [Stall Prevention during RUN = Deceleration Time 1 (C1-02), Deceleration Time 2 (C1-04)].
- When $L3-23 = 1$ [Stall P Reduction at Constant HP = Automatic Reduction @ CHP Region], the drive will automatically decrease the level in the constant output range.
- The upper limit of the setting range changes when $C6-01$ [Normal / Heavy Duty Selection] changes.
 –150% when $C6-01 = 0$ [Heavy Duty Rating 1 (HD1) for Constant Torque Applications].
 –110% when $C6-01 = 1$ [Normal Duty Rating 1 (ND1) for Variable Torque Applications].

Use an Analog Input to Change the Stall Prevent Level during Run

When $H3-xx = 8$ [MFAI Function Select = Stall Prevent Level During Run], you can change the stall prevention level during run through the input gain and bias settings for terminals A1, A2, and A3.

If you set the input level for terminals A1, A2, and A3 [$H3-xx = 8$] and $L3-06$, the drive will use the smaller value for Stall Prevent Level during Run.

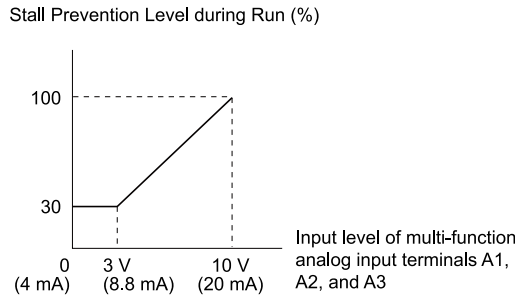

Figure 12.138 Stall Prevention Level during Run with Analog Input

■ L3-11: Overvoltage Suppression Select

No. (Hex.)	Name	Description	Default (Range)
L3-11 (04C7)	Overvoltage Suppression Select	V/f CL-V/f OLV CLV AOLV OLV/PM AOLV/PM CLV/PM EZOLV Sets the overvoltage suppression function.	0 (0, 1)

0 : Disabled

The drive does not adjust the regenerative torque limit or the output frequency. If you apply a regenerative load, the drive can detect an *ov* [Overvoltage] fault. Use this setting with a dynamic braking option.

1 : Enabled

When a regenerative load increases the DC bus voltage, the drive decreases the regenerative torque limit and increases the output frequency to prevent *ov*

■ L3-17: DC Bus Regulation Level

No. (Hex.)	Name	Description	Default (Range)
L3-17 (0462)	DC Bus Regulation Level	V/f CL-V/f OLV CLV AOLV OLV/PM AOLV/PM CLV/PM EZOLV Sets the target value for the DC bus voltage when the overvoltage suppression function and the Decel Stall Prevention function (Intelligent Stall Prevention) are active.	200 V Class: 375 V, 400 V Class: 750 V (200 V Class: 150 to 400 V, 400 V Class: 300 to 800 V)

Note:

This value is initialized when $E1-01$ [Input AC Supply Voltage] is changed.

Sets this parameter for any of the following circumstances.

- $L3-11 = 1$ [OV Suppression Function Select = Enabled].
- $L3-04 = 2$ [Decel Stall Prevention Selection = Automatic Decel Reduction].

■ L3-20: DC Bus Voltage Adjustment Gain

No. (Hex.)	Name	Description	Default (Range)
L3-20 (0465) Expert	DC Bus Voltage Adjustment Gain	V/f CL-V/f OLV CLV AOLV OLV/PM AOLV/PM CLV/PM EZOLV Sets the proportional gain used to control the DC bus voltage.	Determined by A1-02 (0.00 - 5.00)

Set one of these parameters to enable L3-20:

- L2-29 = 1 [Kinetic Energy Backup Method = Single Drive KEB Ride-Thru 2]
- L3-04 = 2 [Stall Prevention during Decel = Intelligent (Ignore Decel Ramp)]
- L3-11 = 1 [Overvoltage Suppression Select = Enabled]
- H1-xx = 7A or 7B [MFDI Function Selection = KEB Ride-Thru 2 Activate (N.O./N.C.)]

Note:

- If stall prevention during deceleration function causes *ov* [Overvoltage] and *Uv1* [DC Bus Undervoltage] faults when you start deceleration and L2-29 = 1, H1-xx = 7A or 7B, or L3-04 = 2, gradually increase this parameter in 0.1-unit increments. If the setting value is too high, it can cause large speed or current ripples.
- If sudden increases in the regenerative load cause *ov* faults and L3-11 = 1, gradually increase this parameter in 0.1-unit increments. If the setting value is too high, it can cause large speed or current ripples.

■ L3-21: OVSUPPRESSION ACCEL/DECEL P GAIN

No. (Hex.)	Name	Description	Default (Range)
L3-21 (0466) Expert	OVSUPPRESSION ACCEL/DECEL P GAIN	<input type="checkbox"/> V/f <input type="checkbox"/> CL-V/f <input type="checkbox"/> OLV <input type="checkbox"/> CLV <input type="checkbox"/> AOLV <input type="checkbox"/> OLV/PM <input type="checkbox"/> AOLV/PM <input type="checkbox"/> CLV/PM <input type="checkbox"/> EZOLV Sets the proportional gain to calculate acceleration and deceleration rates.	Determined by A1-02 (0.10 - 10.00)

Set one of these parameters to enable L3-20:

- L2-29 = 1 [Kinetic Energy Backup Method = Single Drive KEB Ride-Thru 2]
- L3-04 = 2 [Stall Prevention during Decel = Intelligent (Ignore Decel Ramp)]
- L3-11 = 1 [Overvoltage Suppression Select = Enabled]
- H1-xx = 7A or 7B [MFDI Function Selection = KEB Ride-Thru 2 Activate (N.O./N.C.)]

Note:

- If stall prevention during deceleration function causes large speed or current ripples and L2-29 = 1, H1-xx = 7A or 7B, or L3-04 = 2, gradually decrease this parameter in 0.05-unit increments. If the drive detects *ov* [Overvoltage] or *oC* [Overcurrent], decrease L3-21. If you decrease the gain too much, it can cause a delay in control in the DC bus voltage or the deceleration time could be longer than the best deceleration time.
- If sudden increases in the regenerative load cause *ov* faults and L3-11 = 1, gradually increase this parameter in 0.1-unit increments. If there are large speed ripples, gradually decrease this parameter in 0.05-unit increments.

■ L3-22: PM STALL PREVENTION DECEL TIME

No. (Hex.)	Name	Description	Default (Range)
L3-22 (04F9)	PM STALL PREVENTION DECEL TIME	<input type="checkbox"/> V/f <input type="checkbox"/> CL-V/f <input type="checkbox"/> OLV <input type="checkbox"/> CLV <input type="checkbox"/> AOLV <input checked="" type="checkbox"/> OLV/PM <input type="checkbox"/> AOLV/PM <input type="checkbox"/> CLV/PM <input type="checkbox"/> EZOLV Sets the momentary deceleration time that the drive will use when it tries to accelerate a PM motor and detected motor stalls. This function is applicable when L3-01 = 1 [Stall Prevention during Accel = Enabled].	0.0 s (0.0 - 6000.0 s)

Set this parameter to 0.0 s to disable this function. The drive will decelerates in the deceleration time applicable at the time when a motor stall occurs.

■ L3-23: STALL P REDUCTION AT CONSTANT HP

No. (Hex.)	Name	Description	Default (Range)
L3-23 (04FD)	STALL P REDUCTION AT CONSTANT HP	<input type="checkbox"/> V/f <input type="checkbox"/> CL-V/f <input type="checkbox"/> OLV <input type="checkbox"/> CLV <input type="checkbox"/> AOLV <input type="checkbox"/> OLV/PM <input type="checkbox"/> AOLV/PM <input type="checkbox"/> CLV/PM <input type="checkbox"/> EZOLV Sets the function to automatically decrease the Stall Prevention Level during Run for Constant Horse Power (CHP) part of the speed range.	0 (0, 1)

0 : Use L3-06 for Entire Speed Range

The drive uses the level set in L3-06 [Stall Prevent Level during Run] through the full speed range.

1 : Automatic Reduction @ CHP Region

The drive decreases the Stall Prevention level during run in the constant power range. The lower limit is 40% of the L3-06 value.

■ L3-24: MOTOR ACCEL TIME @ RATED TORQUE

No. (Hex.)	Name	Description	Default (Range)
L3-24 (046E) Expert	MOTOR ACCEL TIME @ RATED TORQUE	<input type="checkbox"/> V/f <input type="checkbox"/> CL-V/f <input type="checkbox"/> OLV <input type="checkbox"/> CLV <input type="checkbox"/> AOLV <input type="checkbox"/> OLV/PM <input type="checkbox"/> AOLV/PM <input type="checkbox"/> CLV/PM <input type="checkbox"/> EZOLV Sets the motor acceleration time to reach the maximum frequency at the motor rated torque for stopped single-drive motors.	Determined by o2-04, C6-01, E2-11, and E5-01 (0.001 - 10.000 s)

12.9 L: Protection Functions

Set one of these parameters to enable L3-20:

- $L2-29 = 1$ [Kinetic Energy Backup Method = Single Drive KEB Ride-Thru 2]
- $L3-04 = 2$ [Stall Prevention during Decel = Intelligent (Ignore Decel Ramp)]
- $L3-11 = 1$ [Overvoltage Suppression Select = Enabled]
- $H1-xx = 7A$ or $7B$ [MFDI Function Selection = KEB Ride-Thru 2 Activate (N.O./N.C.)]

Note:

When Auto-Tuning changes the value of $E2-11$ [Motor Rated Power], the drive will automatically set $L3-24$ to the value for a Yaskawa standard motor (4 poles). When you use a PM motor, the drive uses the value in $E5-01$ [PM Motor Code Selection] to change $L3-24$.

Automatically Adjust Parameters

When $A1-02 = 3, 7$ [Control Method Selection = CLV, CLV/PM], do Inertia Tuning. Parameters are automatically adjusted.

Manually Adjust Parameters

Use this formula to find the motor acceleration time:

$$L3-24 = \frac{2\pi \cdot J_{\text{Motor}} \cdot n_{\text{rated}}}{60 \cdot T_{\text{rated}}}$$

- J_{Motor} = Moment of inertia of motor (kg m²)
- n_{rated} = Motor rated speed (min⁻¹, r/min)
- T_{rated} = Motor rated torque (N·m)

The rated torque is calculated using the following expression.

$$T_{\text{rated}} = \frac{60 \cdot P_{\text{Motor}} \cdot 10^3}{2\pi \cdot n_{\text{rated}}}$$

P_{Motor} = Motor Rated Power (kW)

■ L3-25: Load Inertia Ratio

No. (Hex.)	Name	Description	Default (Range)
L3-25 (046F) Expert	Load Inertia Ratio	<div style="display: flex; justify-content: space-between; font-size: 0.8em; font-weight: bold;"> V/f CL-V/f OLV CLV AOLV OLV/PM AOLV/PM CLV/PM EZOLV </div> Sets the ratio between motor inertia and machine inertia.	1.0 (0.1 - 1000.0)

Set one of these parameters to enable L3-20:

- $L2-29 = 1$ [Kinetic Energy Backup Method = Single Drive KEB Ride-Thru 2]
- $L3-04 = 2$ [Stall Prevention during Decel = Intelligent (Ignore Decel Ramp)]
- $L3-11 = 1$ [Overvoltage Suppression Select = Enabled]
- $H1-xx = 7A$ or $7B$ [MFDI Function Selection = KEB Ride-Thru 2 Activate (N.O./N.C.)]

Note:

- If you set this value incorrectly when $L2-29 = 1$, $H1-xx = 7A$ or $7B$, or $L3-11 = 1$, it can cause large current ripples and *ov* [Overvoltage], *Uv1* [DC Bus Undervoltage], or *oC* [Overcurrent] faults.
- KEB Tuning will automatically set this value.

Automatically Adjust Parameters

Do Inertia Tuning when $A1-02 = 3$ or 7 [Control Method Selection = Closed Loop Vector or PM Closed Loop Vector]. The drive automatically adjusts parameters.

Manually Adjust Parameters

Use this formula to find the load inertia ratio:

$$\text{Load inertia ratio} = \frac{\text{Machine inertia (Motor shaft conversion value)}}{\text{Motor inertia}}$$

■ L3-26: Additional DC Bus Capacitors

No. (Hex.)	Name	Description	Default (Range)
L3-26 (0455) Expert	Additional DC Bus Capacitors	<div style="display: flex; justify-content: space-between; font-size: 0.8em; font-weight: bold;"> V/f CL-V/f OLV CLV AOLV OLV/PM AOLV/PM CLV/PM EZOLV </div> Sets the capacity for external main circuit capacitors. Usually it is not necessary to change this setting. Sets this parameter when you use the KEB Ride-Thru function.	0 μF (0 to 65000 μF)

■ L3-27: Stall Prevention Detection Time

No. (Hex.)	Name	Description	Default (Range)
L3-27 (0456)	Stall Prevention Detection Time	<div style="display: flex; justify-content: space-between; align-items: center;"> V/f CL-V/f OLV CLV AOLV OLV/PM AOLV/PM CLV/PM EZOLV </div> Sets a delay time between reaching the Stall Prevention level and starting the Stall Prevention function.	50 ms (0 - 5000 ms)

■ L3-34: Torque Limit Delay Time

No. (Hex.)	Name	Description	Default (Range)
L3-34 (016F) Expert	Torque Limit Delay Time	<div style="display: flex; justify-content: space-between; align-items: center;"> V/f CL-V/f OLV CLV AOLV OLV/PM AOLV/PM CLV/PM EZOLV </div> Sets the filter time constant that returns the torque limit to its initial value when KEB operation operates in Single Drive KEB Ride-Thru mode.	Determined by A1-02 (0.000 - 1.000 s)

When vibration occurs during operation of Single Drive KEB Ride-Thru 2, increase this parameter in 0.010-unit increments.

Note:

The Single Drive KEB Ride-Thru 2 mode operates when $L2-29 = 1$ [KEB Method Selection = Single Drive KEB Ride-Thru 2] and $H1-xx = 7A$ or $7B$ [Terminal Sx Function Selection = KEB Ride-Thru 2 (N.C./N.O.)].

■ L3-35: Speed Agree Width for Auto Decel

No. (Hex.)	Name	Description	Default (Range)
L3-35 (0747) Expert	Speed Agree Width for Auto Decel	<div style="display: flex; justify-content: space-between; align-items: center;"> V/f CL-V/f OLV CLV AOLV OLV/PM AOLV/PM CLV/PM EZOLV </div> Sets the width for speed agreement when $L3-04 = 2$ [Stall Prevention during Decel = Intelligent (Ignore Decel Ramp)]. Usually it is not necessary to change this setting.	0.00 Hz (0.00 - 1.00 Hz)

Set this parameter when hunting occurs while you use a frequency reference through an analog input.

■ L3-36: Current Suppression Gain@Accel

No. (Hex.)	Name	Description	Default (Range)
L3-36 (11D0)	Current Suppression Gain@Accel	<div style="display: flex; justify-content: space-between; align-items: center;"> V/f CL-V/f OLV CLV AOLV OLV/PM AOLV/PM CLV/PM EZOLV </div> Sets the gain to suppress current and motor speed hunting during operation when $L3-01 = 3$ [Stall Prevention during Accel = Current Limit Method]. Usually it is not necessary to change this setting.	Determined by A1-02 (0.0 - 100.0)

If there is vibration in the output current during acceleration, increase the setting value.

Note:

Set $L3-01 = 3$ [Stall Prevention during Accel = Current Limit Method] to enable this function.

■ L3-37: Current Limit P Gain @Accel

No. (Hex.)	Name	Description	Default (Range)
L3-37 (11D1) Expert	Current Limit P Gain @Accel	<div style="display: flex; justify-content: space-between; align-items: center;"> V/f CL-V/f OLV CLV AOLV OLV/PM AOLV/PM CLV/PM EZOLV </div> Suppresses current hunting during acceleration. Usually it is not necessary to change this setting.	5 ms (0 - 100 ms)

Note:

Set $L3-01 = 3$ [Stall Prevention during Accel = Current Limit Acceleration] to enable this function.

■ L3-38: Current Limit I Time @ Accel

No. (Hex.)	Name	Description	Default (Range)
L3-38 (11D2) Expert	Current Limit I Time @ Accel	<div style="display: flex; justify-content: space-between; align-items: center;"> V/f CL-V/f OLV CLV AOLV OLV/PM AOLV/PM CLV/PM EZOLV </div> Suppresses current hunting and overshooting that occurs when the drive stalls during acceleration. Usually it is not necessary to change this setting.	10.0 (0.0 - 100.0)

Note:

Set $L3-01 = 3$ [Stall Prevention during Accel = Current Limit Method] to enable this function.

■ **L3-39: Current Limit Filter Time@Accel**

No. (Hex.)	Name	Description	Default (Range)
L3-39 (11D3)	Current Limit Filter Time@Accel	<div style="display: flex; justify-content: space-between; align-items: center;"> V/f CL-V/f OLV CLV AOLV OLV/PM AOLV/PM CLV/PM EZOLV </div> <p>Sets the time constant to adjust the acceleration rate when $L3-01 = 3$ [Stall Prevention during Accel = Current Limit Acceleration]. Usually it is not necessary to change this setting.</p>	100.0 ms (1.0 - 1000.0 ms)

Note:

Set $L3-01 = 3$ [Stall Prevention during Accel = Current Limit Acceleration] to enable this function.

■ **L3-40: Current Limit S-Curve @ Acc/Dec**

No. (Hex.)	Name	Description	Default (Range)
L3-40 (11D4)	Current Limit S-Curve @ Acc/Dec	<div style="display: flex; justify-content: space-between; align-items: center;"> V/f CL-V/f OLV CLV AOLV OLV/PM AOLV/PM CLV/PM EZOLV </div> <p>Sets the function to enable and disable the best S-curve characteristic used for current-limited acceleration.</p>	0 (0, 1)

Makes the best motor acceleration rate for start up. If you set this parameter to 1, it will make acceleration smoother, but it can also increase the acceleration time to be longer than the set time. If the drive detects oC [Overcurrent] faults immediately after acceleration starts, set this parameter.

0 : Disable

1 : Enabled

Note:

Set $L3-01 = 3$ [Stall Prevention during Accel = Current Limit Method] to enable this function.

◆ **L4: Speed Detection**

$L4$ parameters set the output of signals to the MFDO terminals, for example frequency agree and speed detection. The drive detects motor speed in CLV or CLV/PM control methods.

■ **L4-01: Speed Agree Detection Level**

No. (Hex.)	Name	Description	Default (Range)
L4-01 (0499)	Speed Agree Detection Level	<div style="display: flex; justify-content: space-between; align-items: center;"> V/f CL-V/f OLV CLV AOLV OLV/PM AOLV/PM CLV/PM EZOLV </div> <p>Sets the level to detect speed agree or motor speed when $H2-01$ to $H2-03 = 2, 3, 4, 5$ [MFDO Function Selection = Speed Agree 1, User-set Speed Agree 1, Frequency Detection 1, Frequency Detection 2].</p>	Determined by A1-02 (Determined by A1-02)

■ **L4-02: Speed Agree Detection Width**

No. (Hex.)	Name	Description	Default (Range)
L4-02 (049A)	Speed Agree Detection Width	<div style="display: flex; justify-content: space-between; align-items: center;"> V/f CL-V/f OLV CLV AOLV OLV/PM AOLV/PM CLV/PM EZOLV </div> <p>Sets the width to detect speed agree or motor speed.</p>	Determined by A1-02 (Determined by A1-02)

Sets the width to detect speed agree or motor speed when $H2-01$ to $H2-03 = 2, 3, 4, 5$ [MFDO Function Select = Speed Agree 1, User-set Speed Agree 1, Frequency Detection 1, Frequency Detection 2].

■ **L4-03: Speed Agree Detection Level (+/-)**

No. (Hex.)	Name	Description	Default (Range)
L4-03 (049B)	Speed Agree Detection Level (+/-)	<div style="display: flex; justify-content: space-between; align-items: center;"> V/f CL-V/f OLV CLV AOLV OLV/PM AOLV/PM CLV/PM EZOLV </div> <p>Sets the level to detect speed agree or motor speed.</p>	Determined by A1-02 (Determined by A1-02)

Sets the speed agree detection level or motor speed detection level when $H2-01$ to $H2-03 = 13, 14, 15, 16$ [MFDO Function Selection = Speed Agree 2, User-set Speed Agree 2, Frequency Detection 3, Frequency Detection 4].

■ **L4-04: Speed Agree Detection Width (+/-)**

No. (Hex.)	Name	Description	Default (Range)
L4-04 (049C)	Speed Agree Detection Width (+/-)	<div style="display: flex; justify-content: space-between; align-items: center;"> V/f CL-V/f OLV CLV AOLV OLV/PM AOLV/PM CLV/PM EZOLV </div> <p>Sets the width to detect speed agree or motor speed.</p>	Determined by A1-02 (Determined by A1-02)

Sets the width to detect speed agree or motor speed when $H2-01$ to $H2-03 = 13, 14, 15, 16$ [MFDO Function Selection = Speed Agree 2, User-set Speed Agree 2, Frequency Detection 3, Frequency Detection 4].

■ L4-05: Fref Loss Detection Selection

No. (Hex.)	Name	Description	Default (Range)
L4-05 (049D)	Fref Loss Detection Selection	<input type="checkbox"/> V/f <input type="checkbox"/> CL-V/f <input type="checkbox"/> OLV <input type="checkbox"/> CLV <input type="checkbox"/> AOLV <input type="checkbox"/> OLV/PM <input type="checkbox"/> AOLV/PM <input type="checkbox"/> CLV/PM <input type="checkbox"/> EZOLV Sets the operation when the drive detects a loss of frequency reference.	0 (0, 1)

Enables the detection of a loss of an analog frequency reference when the frequency reference is input from the MFAI terminals (A1, A2, and A3). Set $H2-01$ to $H2-03 = C$ [MFDO Function Select = Frequency Reference Loss] for a digital output to trigger when frequency reference loss occurs.

If the frequency reference is less than 10% in 400 ms, the drive detects frequency reference loss.

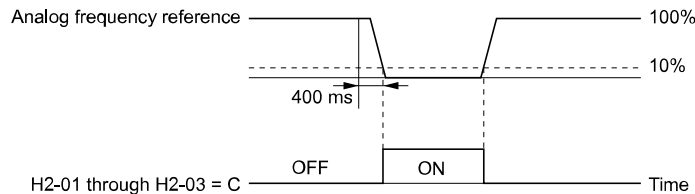

Figure 12.139 Detection of Frequency Reference Loss

0 : Stop

The drive follows the frequency reference and stops the motor.

1 : Run at (L4-06 x Last Reference)

The drive continues to operate at the frequency reference value set in $L4-06$ [FreqReference at Reference Loss]. When you return the external frequency reference value, the drive continues to operate with the frequency reference.

■ L4-06: Frequency Reference @Loss of Ref

No. (Hex.)	Name	Description	Default (Range)
L4-06 (04C2)	Frequency Reference @Loss of Ref	<input type="checkbox"/> V/f <input type="checkbox"/> CL-V/f <input type="checkbox"/> OLV <input type="checkbox"/> CLV <input type="checkbox"/> AOLV <input type="checkbox"/> OLV/PM <input type="checkbox"/> AOLV/PM <input type="checkbox"/> CLV/PM <input type="checkbox"/> EZOLV Sets the frequency reference as a percentage to continue drive operation after it detects a frequency reference loss. The value is a percentage of the frequency reference before the drive detected the loss.	80.0% (0.0 - 100.0%)

Set $L4-05 = 1$ [Fref Loss Detection Selection = Run at (L4-06 x Last Reference)] to enable this parameter.

■ L4-07: Speed Agree Detection Selection

No. (Hex.)	Name	Description	Default (Range)
L4-07 (0470)	Speed Agree Detection Selection	<input type="checkbox"/> V/f <input type="checkbox"/> CL-V/f <input type="checkbox"/> OLV <input type="checkbox"/> CLV <input type="checkbox"/> AOLV <input type="checkbox"/> OLV/PM <input type="checkbox"/> AOLV/PM <input type="checkbox"/> CLV/PM <input type="checkbox"/> EZOLV Sets the condition that activates speed detection.	0 (0, 1)

0 : No Detection during Baseblock

Detects the frequency while the drive is operating. When the drive turns off its output, it will not detect frequency.

1 : Detection Always Enabled

◆ L5: Fault Restart

The Auto Restart function tries to keep machines operating when the drive detects a transient fault.

The drive can do a self-diagnostic check and continue the operation after a fault. If the cause of the fault goes away, the drive does speed search and restarts. It will not stop and the drive will not record a fault history. Use $L5-02$ [Fault Contact at Restart Select] to select the operation of fault relay signals during Auto Restart operation.

Sets if the drive will do Auto Restart and the number of times the drive will try to do Auto Restart in a set time. If the number of Auto Restart tries is more than the set value during the set time, drive output shuts off and operation stops. If this happens, remove the cause of the fault and manually restart the drive.

WARNING! Sudden Movement Hazard. Do not use the fault restart function in hoist or lifting applications. Failure to obey can cause death or serious injury.

The drive can do Auto Restart when these faults occur:

Note:

You can disable Auto Restart for some faults if you must not restart the machine after the fault with parameters L5-07 and L5-08.

Table 12.76 List of Faults during which Auto Restart is Available

Fault	Name	Parameters to Disable Auto Restart	Fault	Name	Parameters to Disable Auto Restart
GF	Ground Fault	L5-08	ov	Overvoltage	L5-08
LF	Output Phase Loss	-	PF	Input Phase Loss	-
oC	Overcurrent	-	rH	Braking Resistor Overheat	-
oH1	Heatsink Overheat	L5-08	rr	Dynamic Braking Transistor Fault	-
oL1	Motor Overload	L5-07	STPo	Motor Step-Out Detected	-
oL2	Drive Overload	L5-07	Uv1	DC Bus Undervoltage ^{*1}	L5-08
oL3	Overtorque Detection 1	L5-07			
oL4	Overtorque Detection 2	L5-07			

*1 Uv1 is the target for the auto restart process when L2-01 = 1, 2, 3, or 4 [Power Loss Ride Through Select = Enabled for L2-02 Time, Enabled while CPU Power Active, Kinetic Energy Backup: L2-02, or Kinetic Energy Backup: CPU Power].

■ L5-01: Number of Auto-Restart Attempts

No. (Hex.)	Name	Description	Default (Range)
L5-01 (049E)	Number of Auto-Restart Attempts	V/f CL-V/f OLV CLV AOLV OLV/PM AOLV/PM CLV/PM EZOLV Sets the number of times that the drive will try to restart.	0 (0 - 10 times)

The drive resets the number of Auto Restart attempts to 0 in these conditions:

- The drive operates correctly for 10 minutes after a fault restart.
- When you manually clear a fault after the drive triggers protective functions.
- When you re-energize the drive.

■ L5-02: Fault Contact at Restart Select

No. (Hex.)	Name	Description	Default (Range)
L5-02 (049F)	Fault Contact at Restart Select	V/f CL-V/f OLV CLV AOLV OLV/PM AOLV/PM CLV/PM EZOLV Sets the function that sends signals to the MFDO terminal set for Fault [H2-xx = E] while the drive is automatically restarting.	0 (0, 1)

0 : Active Only when Not Restarting

1 : Always Active

■ L5-03: Continuous Method Max Restart T

No. (Hex.)	Name	Description	Default (Range)
L5-03 (04A0)	Continuous Method Max Restart T	V/f CL-V/f OLV CLV AOLV OLV/PM AOLV/PM CLV/PM EZOLV Sets the time for which the drive will try to restart. If the drive cannot restart in the time set in L5-03, the drive detects a fault. This is available when L5-05 = 0 [Auto-Restart Method = Continuous/Immediate Attempts].	10.0 s (0.5 - 180.0 s)

■ L5-04: Interval Method Restart Time

No. (Hex.)	Name	Description	Default (Range)
L5-04 (046C)	Interval Method Restart Time	V/f CL-V/f OLV CLV AOLV OLV/PM AOLV/PM CLV/PM EZOLV Sets the time interval between each Auto Restart attempt. This function is enabled when L5-05 = 1 [Auto Restart Operation Selection = Use L5-04 Time].	10.0 s (0.5 - 600.0 s)

■ L5-05: Auto-Restart Method

No. (Hex.)	Name	Description	Default (Range)
L5-05 (0467)	Auto-Restart Method	V/f CL-V/f OLV CLV AOLV OLV/PM AOLV/PM CLV/PM EZOLV Sets the count method for the Auto Restart operation.	0 (0, 1)

0 : Continuous/Immediate Attempts

Counts the number of successful fault resets through Auto Restart.

When this value > *L5-01*, the drive will send a fault signal and fault code to the keypad and the motor will coast to stop.

1 : Interval/Attempt after L5-04 sec

Counts the number of all fault resets (successful and unsuccessful) through Auto Restart. The drive repeats the Auto Restart process in the intervals set in *L5-04* [*Interval Method Restart Time*].

When this value > *L5-01*, the drive will send a fault signal and fault code to the keypad and the motor will coast to stop.

■ L5-07: Fault Reset Enable Select Grp1

No. (Hex.)	Name	Description	Default (Range)
L5-07 (0B2A)	Fault Reset Enable Select Grp1	 Use these 4 digits to set the Auto Restart function for <i>oL1</i> to <i>oL4</i> . From left to right, the digits set <i>oL1</i> , <i>oL2</i> , <i>oL3</i> , and <i>oL4</i> , in order.	1111 (0000 - 1111)

0000 : Disabled

0001 : Enabled (—/—/—/oL4)

0010 : Enabled (—/—/oL3/—)

0011 : Enabled (—/—/oL3/oL4)

0100 : Enabled (—/oL2/—/—)

0101 : Enabled (—/oL2/—/oL4)

0110 : Enabled (—/oL2/oL3/—)

0111 : Enabled (—/oL2/oL3/oL4)

1000 : Enabled (oL1/—/—/—)

1001 : Enabled (oL1/—/—/oL4)

1010 : Enabled (oL1/—/oL3/—)

1011 : Enabled (oL1/—/oL3/oL4)

1100 : Enabled (oL1/oL2/—/—)

1101 : Enabled (oL1/oL2/—/oL4)

1110 : Enabled (oL1/oL2/oL3/—)

1111 : Enabled (oL1/oL2/oL3/oL4)

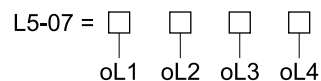



Figure 12.140 Setting Digits and Fault Code

■ L5-08: Fault Reset Enable Select Grp2

No. (Hex.)	Name	Description	Default (Range)
L5-08 (0B2B)	Fault Reset Enable Select Grp2	 Use these 4 digits to set the Auto Restart function for <i>Uv1</i> , <i>ov</i> , <i>oH1</i> , and <i>GF</i> . From left to right, the digits set <i>Uv1</i> , <i>ov</i> , <i>oH1</i> , and <i>GF</i> , in order.	1111 (0000 - 1111)

0000 : Disabled

0001 : Enabled (—/—/—/GF)

0010 : Enabled (—/—/oH1/—)

0011 : Enabled (—/—/oH1/GF)

0100 : Enabled (—/ov/—/—)

0101 : Enabled (—/ov/—/GF)

0110 : Enabled (—/ov/oH1/—)

0111 : Enabled (—/ov/oH1/GF)

1000 : Enabled (Uv1/—/—/—)

- 1001 : Enabled (Uv1/—/—/GF)
- 1010 : Enabled (Uv1/—/oH1/—)
- 1011 : Enabled (Uv1/—/oH1/GF)
- 1100 : Enabled (Uv1/ov/—/—)
- 1101 : Enabled (Uv1/ov/—/GF)
- 1110 : Enabled (Uv1/ov/oH1/—)
- 1111 : Enabled (Uv1/ov/oH1/GF)

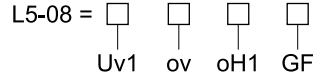

Figure 12.141 Setting Digits and Fault Code

◆ L6: Torque Detection

The overtorque/undertorque detection function prevents damage to machinery and loads.

Overtorque is when there is too much load on the machine. If the motor current or output torque is at the overtorque detection level for the overtorque detection time, the drive will output an alarm and turn off the output.

Undertorque is when a load suddenly decreases. When the motor current or output torque is at the undertorque detection level for the undertorque detection time, the drive will output an alarm and turn off the output.

You can use the undertorque detection function to detect these conditions, for example:

- Machine belt cuts
- Unusual operation of the electromagnetic contactor on the drive output side
- Clogged output side air filters in fans and blowers
- Damage to blade tips and broken string

Note:

If there is *oC* [Overcurrent] or *oL1* [Motor Overload], the drive can stop during overtorque conditions. Use torque detection to identify overload conditions before the drive detects *oC* or *oL1* and stops. Use this function to detect issues that occur in the application.

■ Parameter Settings

You can individually set the two overtorque/undertorque detection functions with the drive. Use the information in [Table 12.77](#) to set the parameters.

Table 12.77 Overtorque/Undertorque Detection Parameters

Configuration Parameter	Overtorque/Undertorque Detection 1	Overtorque/Undertorque Detection 2
MFDO Function Select • Terminal M1-M2 • Terminal M3-M4 • Terminal M5-M6	H2-01, H2-02, and H2-03 = B N.O.: Activated when detected	H2-01, H2-02, and H2-03 = 18 N.O.: Activated when detected
	H2-01, H2-02, and H2-03 = 17 N.C.: Deactivated when detected	H2-01, H2-02, and H2-03 = 19 N.C.: Deactivated when detected
Detection conditions and selection of operation after detection	L6-01	L6-04
Detection Level	L6-02	L6-05
	Analog Input Terminal ^{*1} H3-xx = 7	-
Detection Time	L6-03	L6-06

*1 You can also use an analog input terminal to supply the torque detection level. To enable this function, set *H3-xx = 7* [MFAI Function Selection = Overtorque/Undertorque DetectLv]. If you set *L6-02* and *H3-xx = 7*, the analog input is most important and the drive disables *L6-02*.

You cannot use Overtorque/Undertorque Detection 2 to set the detection level for the analog input terminals.

Note:

The drive sets the Overtorque/Undertorque detection level in these conditions:

- V/f, CL-V/f, OLV/PM: Current level (drive rated current = 100%)
- OLV, CLV, AOLV, AOLV/PM, CLV/PM, EZOLV: Motor torque (Motor rated torque = 100%)
- *L6-08 ≠ 0* [Mechanical Fatigue Detect Select ≠ Disabled]: Current level (drive rated output current = 100%)

■ Time Chart for Detection of Overtorque/Undertorque

Overtorque Detection Time Chart

When you use Overtorque/Undertorque Detection 1, the drive detects overtorque if the motor current or motor torque is at the detection level set in *L6-02 [Torque Detection Level 1]* for the time set in *L6-03 [Torque Detection Time 1]*. Parameter *L6-01 [Torque Detection Selection 1]* sets the operation after detection.

When you use Overtorque/Undertorque Detection 2, set *L6-04 [Torque Detection Selection 2]*, *L6-05 [Torque Detection Level 2]*, and *L6-06 [Torque Detection Time 2]*.

Use *H2-01 to H2-03 [MFDO Function Select]* to set the terminal that outputs the alarm.

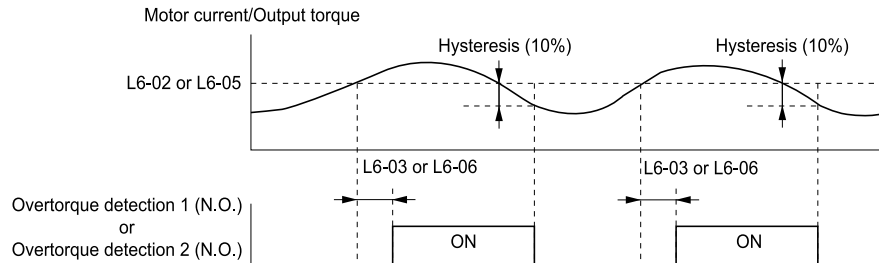

Figure 12.142 Overtorque Detection Time Chart

Note:

The drive applies a hysteresis of approximately 10% of the drive rated output current or the motor rated torque to the overtorque/undertorque detection function.

Undertorque Detection Time Chart

When you use Overtorque/Undertorque Detection 1, the drive detects undertorque if the motor current or motor torque is less than or equal to the detection level set in *L6-02* for the time set in *L6-03*. Parameter *L6-01* sets the operation after detection.

When you use Overtorque/Undertorque Detection 2, set the operation in *L6-04*, *L6-05*, and *L6-06*.

Use *H2-01 to H2-03 [MFDO Function Select]* to set the terminal that outputs the alarm.

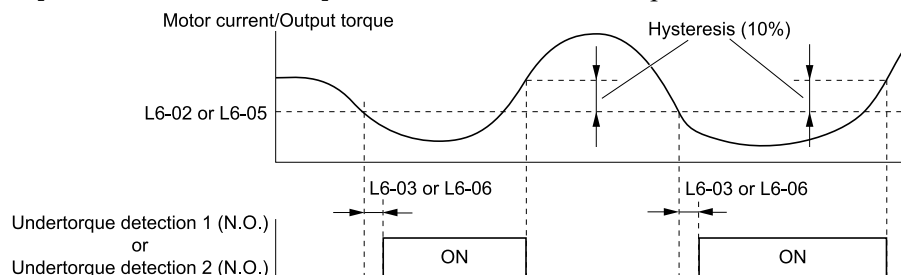

Figure 12.143 Undertorque Detection Time Chart

Note:

The drive applies a hysteresis of approximately 10% of the drive rated output current or the motor rated torque to the overtorque/undertorque detection function.

■ Mechanical Weakening Detection

The Mechanical Weakening Detection function detects the mechanical weakening of a machine that can cause overtorque or undertorque because of motor speed and total drive operation time.

The drive activates the function if the drive total operation time is longer than the time set in *L6-11 [Mech Fatigue Hold Off Time]*. You can use *U4-01 [Cumulative Ope Time]* to monitor the total operation time.

Parameter Settings

The drive detects Mechanical Weakening if overtorque or undertorque occur during the speed range set in *L6-08 [Mechanical Fatigue Detect Select]* and *L6-09 [Mech Fatigue Detect Speed Level]* for the length of time set in *L6-10 [Mech Fatigue Detect Delay Time]*. The drive uses *L6-01 to L6-03 [Torque Detection 1 Setting Parameter]* to detect *oL5 [Mechanical Weakening Detection 1]* or *UL5 [Mechanical Weakening Detection 2]*. Parameter *L6-08* sets the operation after detection.

Set the terminal that outputs the fault in *H2-01 to H2-03 [MFDO Function Select]*.

Table 12.78 Mechanical Weakening Detection Settings Parameters

Configuration Parameter		Mechanical Deterioration Detection
MFDO Function Select • Terminals M1-M2 • Terminals M3-M4 • Terminals M5-M6		H2-01, H2-02, and H2-03 = 22
Operation Selection after Detection		L6-08
Detection Start Time		L6-11
Speed Range	Detection Criteria	L6-08
	Detection Level	L6-09
	Detection Time	L6-10
Overtorque	Detection Criteria	L6-01
	Detection Level	L6-02
	Detection Time	L6-03

■ **L6-01: Torque Detection Selection 1**

No. (Hex.)	Name	Description	Default (Range)
L6-01 (04A1)	Torque Detection Selection 1	V/f CL-V/f OLV CLV AOLV OLV/PM AOLV/PM CLV/PM EZOLV Sets torque detection conditions that will trigger an overtorque or undertorque response from the drive.	0 (0 - 8)

The drive detects overtorque if the motor current or output torque is more than the level set in *L6-02 [Torque Detection Level 1]* for the length of time set in *L6-03 [Torque Detection Time 1]*. The drive detects undertorque if the motor current or output torque is less than the level set in *L6-02* for the length the time set in *L6-03*.

0 : Disabled

The drive will not detect overtorque or undertorque.

1 : oL @ Speed Agree - Alarm only

The drive detects overtorque when the output frequency aligns with the frequency reference. Detection does not occur during acceleration/deceleration. The drive outputs an *oL3 [Overtorque Detection 1]* and operation continues.

2 : oL @ RUN - Alarm only

When the Run command is enabled, the drive constantly detects overtorque. The drive outputs an *oL3* and operation continues.

3 : oL @ Speed Agree - Fault

The drive detects overtorque when the output frequency aligns with the frequency reference. Detection does not occur during acceleration/deceleration. The drive outputs an *oL3* and operation stops.

4 : oL @ RUN - Fault

When the Run command is enabled, the drive constantly detects overtorque. The drive outputs an *oL3* and operation stops.

5 : UL @ Speed Agree - Alarm only

The drive detects undertorque when the output frequency aligns with the frequency reference. Detection does not occur during acceleration/deceleration. The drive outputs a *UL3 [Undertorque Detection 1]* and operation continues.

6 : UL @ RUN - Alarm only

When the Run command is enabled, the drive constantly detects undertorque. The drive outputs a *UL3* and operation continues.

7 : UL @ Speed Agree - Fault

The drive detects undertorque when the output frequency aligns with the frequency reference. Detection does not occur during acceleration/deceleration. The drive outputs a *UL3* and operation stops.

8 : UL @ RUN - Fault

When the Run command is enabled, the drive constantly detects undertorque. The drive outputs a *UL3* and operation stops.

■ L6-02: Torque Detection Level 1

No. (Hex.)	Name	Description	Default (Range)
L6-02 (04A2)	Torque Detection Level 1	V/f CL-V/f OLV CLV AOLV OLV/PM AOLV/PM CLV/PM EZOLV Sets the detection level for Overtorque/Undertorque Detection 1. In V/f control, drive rated output current = 100% value. In vector control, motor rated torque = 100% value.	150% (0 - 300%)

Note:

- Set the torque detection level as a percentage of the drive rated output current in all control methods to set the mechanical weakening detection level.
- You can also use an analog input terminal to supply the torque detection level. To enable this function, set $H3-xx = 7$ [MFAI Function Select = Overtorque/Undertorque DetectLvl]. If you set L6-02 and $H3-x = 7$, the analog input is most important and the drive disables L6-02.

■ L6-03: Torque Detection Time 1

No. (Hex.)	Name	Description	Default (Range)
L6-03 (04A3)	Torque Detection Time 1	V/f CL-V/f OLV CLV AOLV OLV/PM AOLV/PM CLV/PM EZOLV Sets the detection time for Overtorque/Undertorque Detection 1.	0.1 s (0.0 - 10.0 s)

■ L6-04: Torque Detection Selection 2

No. (Hex.)	Name	Description	Default (Range)
L6-04 (04A4)	Torque Detection Selection 2	V/f CL-V/f OLV CLV AOLV OLV/PM AOLV/PM CLV/PM EZOLV Sets the speed range that detects overtorque and undertorque and the operation of drives (operation status) after detection.	0 (0 - 8)

The drive detects overtorque if the motor current or output torque is more than the level set in L6-05 [Torque Detection Level 2] for the length of time set in L6-06 [Torque Detection Time 2]. The drive detects undertorque if the motor current or output torque is less than the level set in L6-05 for the length the time set in L6-06.

0 : Disabled

The drive will not detect overtorque or undertorque.

1 : oL @ Speed Agree - Alarm only

The drive detects overtorque when the output frequency aligns with the frequency reference. Detection does not occur during acceleration/deceleration. The drive outputs an oL4 [Overtorque Detection 2] and operation continues.

2 : oL @ RUN - Alarm only

When the Run command is enabled, the drive constantly detects overtorque. The drive outputs an oL4 and operation continues.

3 : oL @ Speed Agree - Fault

The drive detects overtorque when the output frequency aligns with the frequency reference. Detection does not occur during acceleration/deceleration. The drive outputs an oL4 [Overtorque Detection 2] and operation stops.

4 : oL @ RUN - Fault

When the Run command is enabled, the drive constantly detects overtorque. The drive outputs an oL4 and operation stops.

5 : UL @ Speed Agree - Alarm only

The drive detects undertorque when the output frequency aligns with the frequency reference. Detection does not occur during acceleration/deceleration. The drive outputs a UL4 [Undertorque Detection 2] and operation continues.

6 : UL @ RUN - Alarm only

When the Run command is enabled, the drive constantly detects undertorque. The drive outputs a UL4 and operation continues.

7 : UL @ Speed Agree - Fault

The drive detects undertorque when the output frequency aligns with the frequency reference. Detection does not occur during acceleration/deceleration. The drive outputs a UL4 and operation stops.

8 : UL @ RUN - Fault

When the Run command is enabled, the drive constantly detects undertorque. The drive outputs a *UL4* and operation stops

■ **L6-05: Torque Detection Level 2**

No. (Hex.)	Name	Description	Default (Range)
L6-05 (04A5)	Torque Detection Level 2	V/f CL-V/f OLV CLV AOLV OLV/PM AOLV/PM CLV/PM EZOLV Sets the detection level for Overtorque/Undertorque Detection 2. In V/f control, drive rated output current = 100% value. In vector control, motor rated torque = 100% value.	150% (0 - 300%)

Note:

Overtorque/Undertorque Detection 2 cannot set the detection level for the analog input terminal.

■ **L6-06: Torque Detection Time 2**

No. (Hex.)	Name	Description	Default (Range)
L6-06 (04A6)	Torque Detection Time 2	V/f CL-V/f OLV CLV AOLV OLV/PM AOLV/PM CLV/PM EZOLV Sets the detection time for Overtorque/Undertorque Detection 2.	0.1 s (0.0 - 10.0 s)

■ **L6-07: Torque Detection Filter Time**

No. (Hex.)	Name	Description	Default (Range)
L6-07 (04E5)	Torque Detection Filter Time	V/f CL-V/f OLV CLV AOLV OLV/PM AOLV/PM CLV/PM EZOLV Sets the time constant for a primary filter to the torque reference or to the output current used to detect overtorque/undertorque.	0 ms (0 - 1000 ms)

■ **L6-08: Mechanical Fatigue Detect Select**

No. (Hex.)	Name	Description	Default (Range)
L6-08 (0468)	Mechanical Fatigue Detect Select	V/f CL-V/f OLV CLV AOLV OLV/PM AOLV/PM CLV/PM EZOLV Sets the speed where the drive detects mechanical deterioration and how the drive operates (operation status) after detection.	0 (0 - 8)

The drive detects mechanical weakening through overtorque or undertorque as specified by the conditions set in *L6-08 to L6-11 [Mechanical Deterioration Detection Settings Parameters]*. Set overtorque/undertorque detection conditions in *L6-01 to L6-03 [Torque Detection 1 Settings Parameters]*. The drive disables the operation selection set in *L6-01 [Torque Detection Selection 1]*.

0 : Disabled

The drive does not detect mechanical weakening.

1 : oL5 @ Speed > L6-09 - Alarm

When the speed (signed) \geq *L6-09 [Mech Fatigue Detect Speed Level]*, the drive detects mechanical weakening. The drive will detect *oL5 [Mechanical Weakening Detection 1]* and continue operation.

2 : oL5 @ |Speed| > L6-09 - Alarm

When the speed (absolute value) \geq *L6-09*, the drive detects mechanical weakening. The drive will detect *oL5* and continue operation.

3 : oL5 @ Speed > L6-09 - Fault

When the speed (signed) \geq *L6-09*, the drive detects mechanical weakening. The drive will detect *oL5* and stop operation.

4 : oL5 @ |Speed| > L6-09 - Fault

When the speed (absolute value) \geq *L6-09*, the drive detects mechanical weakening. The drive will detect *oL5* and stop operation.

5 : UL5 @ Speed < L6-09 - Alarm

When the speed (signed) \leq *L6-09*, the drive detects mechanical weakening. The drive will detect *UL5 [Mechanical Weakening Detection 2]* and continue operation.

6 : UL5 @ |Speed| < L6-09 - Alarm

When the speed (absolute value) \leq *L6-09*, the drive detects mechanical weakening. The drive will detect *UL5* and continue operation.

7 : UL5 @ Speed < L6-09 - Fault

When the speed (signed) $\leq L6-09$, the drive detects mechanical weakening. The drive will detect *UL5* and stop operation.

8 : UL5 @ |Speed| < L6-09 - Fault

When the speed (absolute value) $\leq L6-09$, the drive detects mechanical weakening. The drive will detect *UL5* and stop operation.

■ L6-09: Mech Fatigue Detect Speed Level

No. (Hex.)	Name	Description	Default (Range)
L6-09 (0469)	Mech Fatigue Detect Speed Level	V/f CL-V/f OLV CLV AOLV OLV/PM AOLV/PM CLV/PM EZOLV Sets the speed level where the drive will operate the mechanical deterioration detection function, as a percentage of the Maximum Output Frequency.	110.0% (-110.0 - 110.0%)

Parameters *L6-01* to *L6-03* [*Torque Detection 1 Settings Parameters*] set the overtorque/undertorque detection conditions.

When *L6-08* = 2, 4, 6, 8 [*Mechanical Fatigue Detect Select = Speed : unsigned*], the setting value of *L6-09* is the absolute value. When *L6-09* is set to a negative number, the drive processes this value as a positive number.

■ L6-10: Mech Fatigue Detect Delay Time

No. (Hex.)	Name	Description	Default (Range)
L6-10 (046A)	Mech Fatigue Detect Delay Time	V/f CL-V/f OLV CLV AOLV OLV/PM AOLV/PM CLV/PM EZOLV Sets the time for mechanical deterioration detection.	0.1 s (0.0 - 10.0 s)

When the detection conditions set in *L6-08* [*Mechanical Weakening Detect Ope*] continue for the time set in *L6-10*, the drive will detect mechanical weakening.

■ L6-11: Mech Fatigue Hold Off Time

No. (Hex.)	Name	Description	Default (Range)
L6-11 (046B)	Mech Fatigue Hold Off Time	V/f CL-V/f OLV CLV AOLV OLV/PM AOLV/PM CLV/PM EZOLV Sets the time that the drive will start mechanical deterioration detection triggered by the cumulative operation time of the drive.	0 h (0 - 65535 h)

When the total operation time of the drive is more than the value set in *L6-11*, the drive will detect mechanical weakening. Use *U4-01* [*Cumulative Ope Time*] to monitor the drive total operation time.

◆ L7: Torque Limit

The torque limit function limits the internal torque reference for the drive to limit the quantity of torque generated by the motor to a constant quantity. This function keeps the torque applied to loads and regenerative torque less than a set quantity. This function also prevents damage to machinery and increases the reliability of continuous operation. You can set torque limits individually for the four quadrants, which include torque direction (motoring/regeneration) and direction of motor rotation (forward/reverse). When the torque reference value is at the set torque limit, the MFDO terminal set for *During Torque Limit* [*H2-xx = 30*] activates.

Note:

- The drive output current limits maximum output torque. The drive limits torque to 150% of the rated output current for Heavy Duty Rating (HD) and to 110% of the rated output current for Normal Duty Rating (ND). The actual output torque is not more than the limits of the drive rated output current when you set the torque limit to a high value.
- When you use torque limits for lifting applications, do not lower the torque limit value too much. When the torque limit function is triggered, falls and rollbacks can occur because of sudden acceleration stops and stalls of the motor.

■ Configuring Settings

Use one of these methods to set torque limits:

- Individually set the four torque limit quadrants using *L7-01* to *L7-04* [*Torque Limit*].
- Use MFAI to individually set the four torque limit quadrants. Set *H3-02*, *H3-06*, *H3-10* = 10, 11, 12 [*MFAI Function Select = Forward/Reverse/Regenerative Torque Limit*].
- Use MFAI to set all four torque limit quadrants together. Set *H3-02*, *H3-06*, *H3-10* = 15 [*General Torque Limit*].
- Use a communication option to set all four torque limit quadrants together.

Figure 12.144 shows the configuration method for each quadrant.

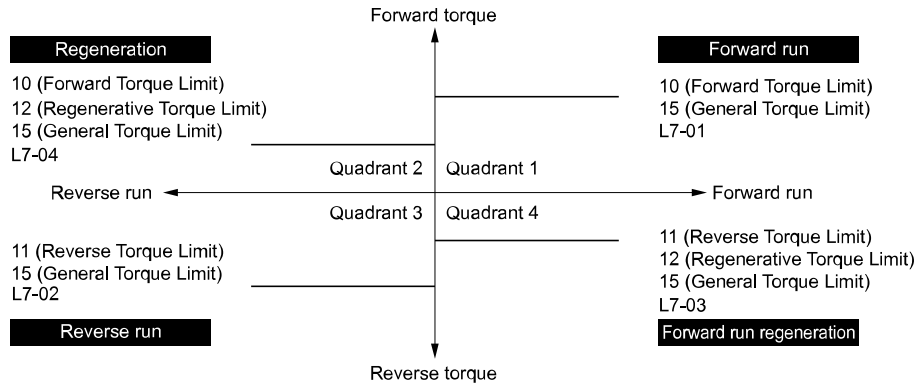

Figure 12.144 Torque Limits and Analog Input Setting Parameters

Note:

- When L7-01 to L7-04 and analog inputs or communication option torque limits set torque limits for the same quadrant, the drive enables the lower value. In this example of parameter settings, the torque limit for quadrant 1 is 130% and the torque limit for quadrants 2, 3, and 4 is 150%. Settings: L7-01 = 130%, L7-02 to L7-04 = 200%, and MFAI torque limit = 150%
- The drive output current limits maximum output torque. The torque limit is 150% of the rated output current for HD and to 120% of the rated output current for ND. The actual output torque is not more than the limits of the drive rated output current when you set the torque limit to a high value.

■ **L7-01: Forward Torque Limit**

No. (Hex.)	Name	Description	Default (Range)
L7-01 (04A7) RUN	Forward Torque Limit	<input type="checkbox"/> V/f <input type="checkbox"/> CL-V/f <input type="checkbox"/> OLV <input type="checkbox"/> CLV <input type="checkbox"/> AOLV <input type="checkbox"/> OLV/IPM <input type="checkbox"/> AOLV/IPM <input type="checkbox"/> CLV/IPM <input type="checkbox"/> EZOLV Sets the torque limit value for forward motoring as a percentage, where motor rated torque is the 100% value.	200% (0 - 300%)

Note:

- Use this method to set the torque limit and enable the lower torque limit:
 - Set H3-02, H3-06, or H3-10 = 10, 15 [MFAI Function Select = Forward, Reverse/Regenerative Torque Limit].
 - Use a communication option to set the torque limits
- You must think about drive capacity when a large quantity of torque is necessary. If you set the value too high, the drive can detect *oC* [Overcurrent].
- If you set the value too low with large loads, the motor can stall.

■ **L7-02: Reverse Torque Limit**

No. (Hex.)	Name	Description	Default (Range)
L7-02 (04A8) RUN	Reverse Torque Limit	<input type="checkbox"/> V/f <input type="checkbox"/> CL-V/f <input type="checkbox"/> OLV <input type="checkbox"/> CLV <input type="checkbox"/> AOLV <input type="checkbox"/> OLV/IPM <input type="checkbox"/> AOLV/IPM <input type="checkbox"/> CLV/IPM <input type="checkbox"/> EZOLV Sets the torque limit value for reversed motoring as a percentage, where motor rated torque is the 100% value.	200% (0 - 300%)

Note:

- Use this method to set the torque limit and enable the lower torque limit:
 - Set H3-02, H3-06, or H3-10 = 10, 15 [MFAI Function Select = Forward, Reverse/Regenerative Torque Limit].
 - Use a communication option to set the torque limits
- You must think about drive capacity when a large quantity of torque is necessary. If you set the value too high, the drive can detect *oC* [Overcurrent].
- If you set the value too low with large loads, the motor can stall.

■ **L7-03: Forward Regenerative Trq Limit**

No. (Hex.)	Name	Description	Default (Range)
L7-03 (04A9) RUN	Forward Regenerative Trq Limit	<input type="checkbox"/> V/f <input type="checkbox"/> CL-V/f <input type="checkbox"/> OLV <input type="checkbox"/> CLV <input type="checkbox"/> AOLV <input type="checkbox"/> OLV/IPM <input type="checkbox"/> AOLV/IPM <input type="checkbox"/> CLV/IPM <input type="checkbox"/> EZOLV Sets the torque limit value for forward regenerative conditions as a percentage of the motor rated torque.	200% (0 - 300%)

Note:

- Use this method to set the torque limit and enable the lower torque limit:
 - Set H3-02, H3-06, or H3-10 = 10, 15 [MFAI Function Select = Forward, Reverse/Regenerative Torque Limit].
 - Use a communication option to set the torque limits
- You must think about drive capacity when a large quantity of torque is necessary. If you set the value too high, the drive can detect *oC* [Overcurrent].
- If you set the value too low with large loads, the motor can stall.

■ L7-04: Reverse Regenerative Trq Limit

No. (Hex.)	Name	Description	Default (Range)
L7-04 (04AA) RUN	Reverse Regenerative Trq Limit	<div style="display: flex; gap: 5px;"> V/f CL-V/f OLV CLV AOLV OLV/PM AOLV/PM CLV/PM EZOLV </div> Sets the torque limit value for reversed regenerative conditions as a percentage of the motor rated torque.	200% (0 - 300%)

Note:

- Use this method to set the torque limit and enable the lower torque limit:
 - Set H3-02, H3-06, or H3-10 = 10, 15 [MFAI Function Select = Forward, Reverse/Regenerative Torque Limit].
 - Use a communication option to set the torque limits
- You must think about drive capacity when a large quantity of torque is necessary. If you set the value too high, the drive can detect *oC* [Overcurrent].
- If you set the value too low with large loads, the motor can stall.

■ L7-06: Torque Limit Integral Time

No. (Hex.)	Name	Description	Default (Range)
L7-06 (04AC)	Torque Limit Integral Time	<div style="display: flex; gap: 5px;"> V/f CL-V/f OLV CLV AOLV OLV/PM AOLV/PM CLV/PM EZOLV </div> Sets the integral time constant for the torque limit function.	200 ms (5 - 10000 ms)

Decrease the setting value to increase torque limit responsiveness when you use torque limits and L7-07 = 1 [Torque Limit during Accel/Decel = Proportional & Integral control].

If there is hunting when torque limits are active, increase the setting value.

■ L7-07: Torque Limit during Accel/Decel

No. (Hex.)	Name	Description	Default (Range)
L7-07 (04C9)	Torque Limit during Accel/Decel	<div style="display: flex; gap: 5px;"> V/f CL-V/f OLV CLV AOLV OLV/PM AOLV/PM CLV/PM EZOLV </div> Sets the torque limit function during acceleration and deceleration.	0 (0, 1)

0 : Proportional only

The torque limit function works with proportional control during acceleration and deceleration, and switches to integral control at constant speed. Use this setting when quickly reaching the target speed is more important than the torque limit during speed changes.

1 : Proportional & Integral control

The torque limit function always uses integral control. Use this setting when a very accurate torque limit is necessary during speed changes, for example in winding machine applications.

If you make the torque limit the most important, it can:

- Increase the acceleration and deceleration times.
- Not let the motor speed reach the frequency reference value during run at constant speed.

■ L7-16: Torque Limit Process at Start

No. (Hex.)	Name	Description	Default (Range)
L7-16 (044D)	Torque Limit Process at Start	<div style="display: flex; gap: 5px;"> V/f CL-V/f OLV CLV AOLV OLV/PM AOLV/PM CLV/PM EZOLV </div> Assigns a time filter to allow the torque limit to build at start.	1 (0, 1)

0 : Disabled

There is torque limit at start without a delay time.

Use this setting to maximize the response time when sudden acceleration or deceleration at start is necessary.

1 : Enabled

There is a delay time of 64 ms at start to build the torque limit.

■ **L7-35: Low Freq Regen Torque Limit Lvl**

No. (Hex.)	Name	Description	Default (Range)
L7-35 (1B57) Expert	Low Freq Regen Torque Limit Lvl	<div style="display: flex; justify-content: space-between; font-size: small;"> V/f CL-V/f OLV CLV AOLV OLV/PM AOLV/PM CLV/PM EZOLV </div> <p>Sets the torque limit used during low-speed regeneration. Usually it is not necessary to change this setting.</p>	50.0% (0.0 - 200.0%)

Reduces the regenerative torque limit to the level set with L7-35 when using low frequencies such that the output frequency is less than L7-36 [Regen Torque Limit Derate Freq]. The drive does not decrease torque limits during ramp to stop operation. Decrease the setting of L7-35 when oC [Overcurrent] issues occur while a regenerative load is input and the speed reference is constant.

Note:

- Reduce the setting value of L7-35 in increments of 10.0% and reduce the setting value of L7-36 in increments of 2.0 Hz when faults occur during regenerative loads at low speed.
- Setting values that are too high can cause faults.
- The torque limit reduction function does not operate when L7-35 is set with a value larger than L7-03 [Forward Regenerative Trq Limit] or L7-04 [Reverse Regenerative Trq Limit].
- The motor may rotate slightly faster than the reference when a regenerative load is input at low speeds while L7-35 is set to a low value.

■ **L7-36: Regen Torque Limit Derate Freq**

No. (Hex.)	Name	Description	Default (Range)
L7-36 (1B58) Expert	Regen Torque Limit Derate Freq	<div style="display: flex; justify-content: space-between; font-size: small;"> V/f CL-V/f OLV CLV AOLV OLV/PM AOLV/PM CLV/PM EZOLV </div> <p>Sets the frequency width at which L7-35 [Low Freq Regen Torque Limit Lvl] operates.</p>	6.0 Hz (0.0 - 30.0 Hz)

If the drive detects oC [Overcurrent] faults when you connect regenerative loads at low speed, increase the setting value. Decreases the torque limit as specified by the setting of L7-35 in a range of $0 \leq \text{output frequency} < L7-36$. When the torque limit gradually changes as specified by the output frequency until the output frequency = L7-36, the value changes to the setting of L7-03 [Forward Regenerative Trq Limit] and L7-04 [Reverse Regenerative Trq Limit].

Note:

If you increase the setting of L7-36, the motor will rotate at a speed higher than specified when a you input a regenerative load. Do not set the value higher than necessary.

◆ **L8: Drive Protection**

L8 parameters set protective functions that prevent faults such as overheating, phase loss, and ground faults.

■ **L8-01: 3% ERF DB Resistor Protection**

No. (Hex.)	Name	Description	Default (Range)
L8-01 (04AD)	3% ERF DB Resistor Protection	<div style="display: flex; justify-content: space-between; font-size: small;"> V/f CL-V/f OLV CLV AOLV OLV/PM AOLV/PM CLV/PM EZOLV </div> <p>Sets the function to enable braking resistor protection with a Yaskawa ERF series braking resistor (3% ED) installed on the heatsink.</p>	0 (0, 1)

0 : Disabled

Disables braking resistor protection. Use this setting for dynamic braking options that are not Yaskawa ERF series braking resistors.

1 : Enabled

Enables protection for Yaskawa ERF series braking resistors.

Note:

Set L8-01 = 1 and H2-01 to H2-03 = D [MFDO Function Select = Braking Resistor Fault]. Use a sequence to turn OFF power with MFDO.

■ L8-02: Overheat Alarm Level

No. (Hex.)	Name	Description	Default (Range)
L8-02 (04AE)	Overheat Alarm Level	<div style="display: flex; gap: 5px;"> V/f CL-V/f OLV CLV AOLV OLV/PM AOLV/PM CLV/PM EZOLV </div> Sets the <i>oH</i> detection level in temperature.	Determined by o2-04, C6-01 (50 - 150 °C)

If the heatsink temperature is more than the temperature set in this parameter, the drive detects an overheat pre-alarm. To enable this function, set one of *H2-01* to *H2-03* [*MFDO Function Select*] to 20 [*Drive Overheat Pre-Alarm (oH)*].

If the temperature increases to the overheat fault level, the drive will trigger an *oH1* [*Heatsink Overheat*] fault and stop operation.

■ L8-03: Overheat Pre-Alarm Selection

No. (Hex.)	Name	Description	Default (Range)
L8-03 (04AF)	Overheat Pre-Alarm Selection	<div style="display: flex; gap: 5px;"> V/f CL-V/f OLV CLV AOLV OLV/PM AOLV/PM CLV/PM EZOLV </div> Sets the operation of drives when an <i>oH</i> alarm is detected.	3 (0 - 4)

0 : Ramp to Stop

The drive ramps the motor to stop in the deceleration time. Fault relay output terminal MA-MC turns ON, and MB-MC turns OFF.

1 : Coast to Stop

The output turns off and the motor coasts to stop. Fault relay output terminal MA-MC turns ON, and MB-MC turns OFF.

2 : Fast Stop (Use C1-09)

The drive stops the motor in the deceleration time set in *C1-09* [*Fast Stop Time*]. Fault relay output terminal MA-MC turns ON, and MB-MC turns OFF.

3 : Alarm Only

The keypad shows *oH* and the drive continues operation. The output terminal set for *Alarm* [*H2-01* to *H2-03* = 10] activates.

4 : Operate at Reduced Speed (L8-19)

The drive decelerates to the level set in *L8-19* [*Freq Reduction @ oH Pre-Alarm*] and continues operation. *oH* flashes on the keypad.

oH flashes on the keypad. When the alarm is output, the drive decelerates each 10 seconds. If the drive decelerates 10 times and the alarm continues to be output, the output terminal set for *oH Pre-Alarm Reduction Limit* [*H2-01* to *H2-03* = 4D] activates. When the alarm is not output during deceleration, the drive accelerates until it is at the frequency reference that was applicable before the alarm was turned off. [Figure 12.145](#) shows the output of the alarm and the drive operation at a decreased output frequency.

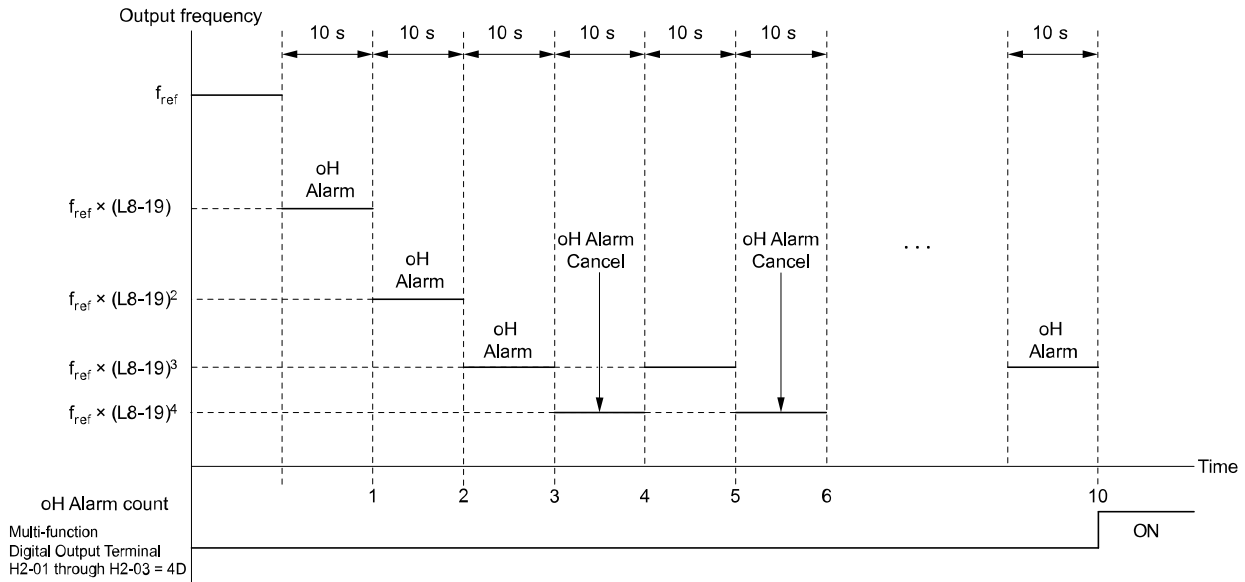

Figure 12.145 Drive Operation at a Decreased Output Frequency when the Overheat Alarm is Output

■ L8-05: Input Phase Loss Protection Sel

No. (Hex.)	Name	Description	Default (Range)
L8-05 (04B1)	Input Phase Loss Protection Sel	V/f CL-V/f OLV CLV AOLV OLV/PM AOLV/PM CLV/PM EZOLV Sets the function to enable and disable input phase loss detection.	1 (0 - 4)

Note:

The default setting and setting range is different for different drive input power supplies.

- Three-phase 200 V and 400 V Input
Default setting: 1
Setting range: Determined by the drive model
-2xxx, 4002 - 4675: 0, 1
-4810 - 4H12: 0 - 4
- 6-Phase/12-Pulse 400 V Input
Default setting: 4
Setting range: 0 - 4

0 : Disabled

1 : Enabled

The drive measures ripples in DC bus voltage to detect input phase loss.

The drive detects phase loss when power supply phase loss occurs or the main circuit capacitor becomes unusable, which causes *PF [Input Phase Loss]* to show on the keypad.

Disable the detection of the input power supply phase loss function in these conditions:

- During deceleration
- The run command is not input
- The output current is less than 30% of the drive rated current.

4 : Enabled, with Hardware Detection

■ L8-07: Output Phase Loss Protection Sel

No. (Hex.)	Name	Description	Default (Range)
L8-07 (04B3)	Output Phase Loss Protection Sel	V/f CL-V/f OLV CLV AOLV OLV/PM AOLV/PM CLV/PM EZOLV Sets the function to enable and disable output phase loss detection. The drive starts output phase loss detection when the output current decreases to less than 5% of the drive rated current.	0 (0 - 2)

Note:

The drive can incorrectly start output phase loss detection in these conditions:

- The motor rated current is very small compared to the drive rating.
- The drive is operating a PM motor with a small load.

0 : Disabled

1 : Fault when one phase is lost

If the drive loses one output phase, it will trigger *LF* [Output Phase Loss].

The output turns off and the motor coasts to stop.

2 : Fault when two phases are lost

If the drive loses more than one output phase, it will trigger *LF* [Output Phase Loss].

The output turns off and the motor coasts to stop.

■ L8-09: Output Ground Fault Detection

No. (Hex.)	Name	Description	Default (Range)
L8-09 (04B5)	Output Ground Fault Detection	V/f CL-V/f OLV CLV AOLV OLV/PM AOLV/PM CLV/PM EZOLV Sets the function to enable and disable ground fault protection.	Determined by o2-04 (0, 1)

0 : Disabled

The drive will not detect ground faults.

1 : Enabled

If there is high leakage current or a ground short circuit in one or two output phases, the drive will detect *GF* [Ground Fault].

Note:

If the ground path impedance is low, the drive can detect *oC* [Overcurrent], *SC* [Short Circuit/IGBT Failure], or *ov* [Overvoltage] instead of *GF*.

■ L8-10: Heatsink Fan Operation Selection

No. (Hex.)	Name	Description	Default (Range)
L8-10 (04B6)	Heatsink Fan Operation Selection	V/f CL-V/f OLV CLV AOLV OLV/PM AOLV/PM CLV/PM EZOLV Sets operation of the heatsink cooling fan.	0 (0 - 2)

0 : During Run, w/ L8-11 Off-Delay

The drive turns on the fan when a Run command is active.

When you release the Run command and the delay time set in *L8-11* [Heatsink Fan Off-Delay Time] is expired, the fan stops. This setting extends the fan lifetime.

1 : Always On

The fan turns on when you supply power to the drive.

2 : Temperature-Dependent Fan Ctrl.

The fan turns on when the drive detects that the main circuit is overheating.

■ L8-11: Heatsink Fan Off-Delay Time

No. (Hex.)	Name	Description	Default (Range)
L8-11 (04B7)	Heatsink Fan Off-Delay Time	V/f CL-V/f OLV CLV AOLV OLV/PM AOLV/PM CLV/PM EZOLV Sets the length of time that the drive will wait before it stops the cooling fan after it cancels the Run command when <i>L8-10</i> = 0 [Heatsink Fan Operation Selection = During Run, w/ L8-11 Off-Delay].	60 s (0 - 300 s)

■ L8-12: Ambient Temperature Setting

No. (Hex.)	Name	Description	Default (Range)
L8-12 (04B8)	Ambient Temperature Setting	V/f CL-V/f OLV CLV AOLV OLV/PM AOLV/PM CLV/PM EZOLV Sets the ambient temperature of the drive installation area.	40 °C (-10 °C - +50 °C)

The drive automatically adjusts the drive rated current to the best value as specified by the set temperature. Set the ambient temperature of the area where you install the drive to a value that is more than the drive rating.

Refer to [Derating Depending on Ambient Temperature on page 474](#) for information about derating depending on ambient temperature.

■ **L8-15: Drive oL2 @ Low Speed Protection**

No. (Hex.)	Name	Description	Default (Range)
L8-15 (04BB)	Drive oL2 @ Low Speed Protection	<div style="display: flex; justify-content: space-between; align-items: center;"> V/f CL-V/f OLV CLV AOLV OLV/PM AOLV/PM CLV/PM EZOLV </div> <p>Sets the function to decrease the drive overload level at which the drive will trigger <i>oL2</i> [Drive Overload] during low speed operation (6 Hz or slower) to prevent damage to the main circuit transistors.</p>	1 (0, 1)

Note:

Contact Yaskawa or your nearest sales representative before disabling this function at low speeds. If you frequently operate drives with high output current in low speed ranges, it can cause heat stress and decrease the life span of drive IGBTs.

0 : Disabled (No Additional Derate)

The drive does not decrease the overload protection level.

Note:

When you use drive models 4810 to 4H12, you cannot set $L8-05 = 0$. Contact Yaskawa or your nearest sales representative before disabling this function at low speed range.

1 : Enabled (Reduced oL2 Level)

When the drive detects *oL2* during low speed operation, it automatically decreases the overload detection level. At zero speed, the drive derates the overload by 50%.

■ **L8-18: Software Current Limit Selection**

No. (Hex.)	Name	Description	Default (Range)
L8-18 (04BE)	Software Current Limit Selection	<div style="display: flex; justify-content: space-between; align-items: center;"> V/f CL-V/f OLV CLV AOLV OLV/PM AOLV/PM CLV/PM EZOLV </div> <p>Set the software current limit selection function to prevent damage to the main circuit transistor caused by too much current.</p>	0 (0, 1)

0 : Disabled

When the output current is at the software current limit value, the drive does not restrict the output voltage.

Note:

The drive may detect an *oC* [Overcurrent] when loads are particularly heavy or the acceleration time is particularly short.

1 : Enabled

When the output current is at the software current limit value, the drive decreases output voltage to decrease output current.

When the output current decreases to the software current limit level, the drive starts usual operation.

■ **L8-19: Freq Reduction @ oH Pre-Alarm**

No. (Hex.)	Name	Description	Default (Range)
L8-19 (04BF)	Freq Reduction @ oH Pre-Alarm	<div style="display: flex; justify-content: space-between; align-items: center;"> V/f CL-V/f OLV CLV AOLV OLV/PM AOLV/PM CLV/PM EZOLV </div> <p>Sets the ratio at which the drive derates the frequency reference during an <i>oH</i> alarm.</p>	0.8 (0.1 - 0.9)

When these two conditions are correct, this function is enabled:

- $L8-03 = 4$ [Overheat Pre-Alarm Ope Selection = Run@L8-19 Rate]
- *oH* alarm is output

■ **L8-20: Control Fault & Step Out Detect**

No. (Hex.)	Name	Description	Default (Range)
L8-20 (04C0) Expert	Control Fault & Step Out Detect	<div style="display: flex; justify-content: space-between; align-items: center;"> V/f CL-V/f OLV CLV AOLV OLV/PM AOLV/PM CLV/PM EZOLV </div> <p>Sets operation after the drive detects a <i>CF</i> fault when $A1-02 = 4$ [Control Method Selection = Advanced Open Loop Vector].</p>	1 (0 - 2)

If you enter a Stop command but it cannot stop drive operation, the drive will detect *CF*.

0 : Disabled

1 : CF/STPo Detection Enabled

2 : CF ALM/Stop

The drive stops DC injection braking as specified by the value of $b2-03$ [DC Inject Braking Time at Start].

Note:

- When $A1-02 = 4$, control will not be stable if you do not do Rotational Auto-Tuning. This can cause CF faults if you ramp to stop. If the drive detects CF , do Rotational Auto-Tuning and Line-to-Line Resistance Tuning. Also, do Line-to-Line Resistance Tuning.
- If you set $A1-02 = 4$ and set these parameters, the drive can detect CF because it cannot stop the operation in some load conditions. Make sure that you do Rotational Auto-Tuning and Line-to-Line Resistance Tuning correctly and then set $L8-20 = 0$.
 $-d5-01 = 1$ [Torque Control Selection = Torque Control]
 $-L3-11 = 1$ [Overvoltage Suppression Select = Enabled]
 $-$ Decreased $L7-01$ to $L7-04$ [Torque Limit].

■ L8-27: Overcurrent Detection Gain

No. (Hex.)	Name	Description	Default (Range)
L8-27 (04DD)	Overcurrent Detection Gain	V/f CL-V/f OLV CLV AOLV OLV/PM AOLV/PM CLV/PM EZOLV Sets the PM motor overcurrent detection level as a percentage of the motor rated current value.	300.0% (0.0 - 1000.0%)

Note:

- The overcurrent detection function detects the lower of these two values:
 $-$ Drive overcurrent level
 $-$ Motor rated current $\times L8-27 / 100$
- Set $L7-xx$ [Torque Limit] parameters to a smaller value than the setting of $L8-27$.
- On drives with software versions PRG:1022 and later, this function is disabled when you set $L8-27 = 0.0$. Under usual circumstances, do not set $L8-27 = 0.0$. If the drive rated current is much higher than the motor rated current, PM motor magnets can demagnetize when current flows at the drive overcurrent detection level. The "PRG" column on the nameplate on the right side of the drive identifies the software version. You can also use $U1-25$ [Software Number] to identify the software version.

■ L8-29: Output Unbalance Detection Sel

No. (Hex.)	Name	Description	Default (Range)
L8-29 (04DF)	Output Unbalance Detection Sel	V/f CL-V/f OLV CLV AOLV OLV/PM AOLV/PM CLV/PM EZOLV Sets the function to detect $LF2$ [Output Current Imbalance].	1 (0, 1)

This function prevents damage to PM motors. Current unbalance can heat a PM motor and demagnetize the magnets. When the current is unbalanced, the drive will detect $LF2$ to stop the motor and prevent damage to the motor.

0 : Disabled

1 : Enabled

Note:

You must set $E9-01 = 1$ [Motor Type Selection = Permanent Magnet (PM)] and $A1-02 = 8$ [EZOLV] to show $L8-29$.

■ L8-31: LF2 Detection Time

No. (Hex.)	Name	Description	Default (Range)
L8-31 (04E1)	LF2 Detection Time	V/f CL-V/f OLV CLV AOLV OLV/PM AOLV/PM CLV/PM EZOLV Sets the $LF2$ [Output Current Imbalance] detection time.	3 (1 - 100)

When the output current is unbalanced for longer than the time set in $L8-31$, the drive detects $LF2$.

Note:

- Set $L8-29 = 1$ [Output Unbalance Detection Sel = Enabled] to enable $L8-31$.
- If the drive incorrectly detects $LF2$, increase $L8-31$ in 5-unit increments.
- The keypad shows $L8-31$ when $E9-01 = 1$ [Motor Type Selection = Permanent Magnet (PM)] in EZ Vector Control.

■ L8-35: Installation Method Selection

No. (Hex.)	Name	Description	Default (Range)
L8-35 (04EC)	Installation Method Selection	V/f CL-V/f OLV CLV AOLV OLV/PM AOLV/PM CLV/PM EZOLV Sets the type of drive installation.	Determined by the drive (0 - 3)

Note:

- Parameter $A1-03$ [Initialize Parameters] does not initialize this parameter.
- This parameter is set to the correct value when the drive is shipped. Side-by-Side installation
 $-$ Change the value only in these conditions:
 $-$ When you install a UL Type 1 kit on an IP20/UL Open Type drive to convert the drive to an IP20/UL Type 1 drive.

The drive automatically adjusts the overload protection detection level to the best value for each setting value. Refer to *Derating Depending on Ambient Temperature on page 474* for information about derating as specified by ambient temperature.

0 : IP00/IP20/UL Open Type/Ex Heatsink

Use this setting to install IP00/IP20/UL Open Type drives or when the heatsink (cooling fin) is outside the enclosure panel.

Make sure that there is 30 mm (1.18 in) minimum of space between drives or between the drive and side of the enclosure panel.

1 : Side-by-Side Mounting

Use this setting to install more than one drive side-by-side.

Make sure that there is 2 mm (0.08 in) minimum of space between drives.

2 : IP20/UL Type 1

Use this setting to install IP20/UL Type 1 drives.

3 : Finless

Use this setting to install a finless drive.

■ **L8-38: Carrier Frequency Reduction**

No. (Hex.)	Name	Description	Default (Range)
L8-38 (04EF)	Carrier Frequency Reduction	<div style="display: flex; justify-content: space-between; font-size: small;"> V/f CL-V/f OLV CLV AOLV OLV/PM AOLV/PM CLV/PM EZOLV </div> <p>Sets the carrier frequency reduction function. The drive reduces the carrier frequency when the output current is more than a specified level.</p>	Determined by A1-02, C6-01 and o2-04 (0 - 2)

If you decrease the carrier frequency, it increases the overload tolerance. The overload capacity increases temporarily for *oL2 [Drive Overloaded]* and lets the drive operate through transient load peaks and not trip.

0 : Disabled

The drive will not decrease the carrier frequency at high current.

1 : Enabled below 6 Hz

The drive decreases the carrier frequency at speeds less than 6 Hz when the current is more than 100% of the drive rated current.

When the current is less than 88% or the output frequency is more than 7 Hz, the drive goes back to the usual carrier frequency.

2 : Enabled for All Speeds

The drive decreases the carrier frequency at these speeds:

- Output current is a minimum of 100% of the drive rated current and the frequency reference is less than 6 Hz.
- Output current is a minimum of 109% of the drive rated current, the drive is in Normal Duty mode, and the frequency reference is 7 Hz or more.
- Output current is a minimum of 112% of the drive rated current, the drive is in Heavy Duty mode, and the frequency reference is 7 Hz or more.

When the drive switches the carrier frequency to the set value, it uses the delay time set in *L8-40 [CarrierFreqReduct Off DelayTime]* and a hysteresis of 12%.

■ **L8-40: Carrier Freq Reduction Off-Delay**

No. (Hex.)	Name	Description	Default (Range)
L8-40 (04F1)	Carrier Freq Reduction Off-Delay	<div style="display: flex; justify-content: space-between; font-size: small;"> V/f CL-V/f OLV CLV AOLV OLV/PM AOLV/PM CLV/PM EZOLV </div> <p>Sets the length of time until the automatically reduced carrier frequency returns to the condition before the reduction.</p>	Determined by A1-02 (0.00 - 2.00 s)

Set *L8-40* $\neq 0.00$ to enable the carrier frequency reduction function during start-up. When operation starts, the drive automatically decreases the carrier frequency. When the time set in *L8-40* is expired, the carrier frequency returns to the value set in *C6-02 [Carrier Frequency Selection]*.

■ L8-41: High Current Alarm Selection

No. (Hex.)	Name	Description	Default (Range)
L8-41 (04F2)	High Current Alarm Selection	<div style="display: flex; justify-content: space-between; align-items: center;"> V/f CL-V/f OLV CLV AOLV OLV/PM AOLV/PM CLV/PM EZOLV </div> <p>Sets the function to cause an <i>HCA</i> [Current Alarm] when the output current is more than 150% of the drive rated current.</p>	0 (0, 1)

0 : Disabled

The drive will not detect *HCA* [Current Alarm].

1 : Enabled

If the output current is more than 150% of the drive rated current, the drive will detect *HCA*.

The MFDO terminal set for an alarm [H2-01 to H2-03 = 10] activates.

■ L8-51: STPo I Detection Level

No. (Hex.)	Name	Description	Default (Range)
L8-51 (0471) Expert	STPo I Detection Level	<div style="display: flex; justify-content: space-between; align-items: center;"> V/f CL-V/f OLV CLV AOLV OLV/PM AOLV/PM CLV/PM EZOLV </div> <p>Sets the <i>STPo</i> [Motor Step-Out Detected] detection level as a percentage of the motor rated current.</p>	0.0% (0.0 - 300.0%)

Note:

The detection level is automatically calculated when *L8-51* = 0.

■ L8-52: STPo Integration Level

No. (Hex.)	Name	Description	Default (Range)
L8-52 (0472) Expert	STPo Integration Level	<div style="display: flex; justify-content: space-between; align-items: center;"> V/f CL-V/f OLV CLV AOLV OLV/PM AOLV/PM CLV/PM EZOLV </div> <p>Sets the detection level for <i>STPo</i> [Motor Step-Out Detected] related to the ACR integral value.</p>	1.0 (0.1 - 2.0)

■ L8-53: STPo Integration Time

No. (Hex.)	Name	Description	Default (Range)
L8-53 (0473) Expert	STPo Integration Time	<div style="display: flex; justify-content: space-between; align-items: center;"> V/f CL-V/f OLV CLV AOLV OLV/PM AOLV/PM CLV/PM EZOLV </div> <p>Sets the length of time until the drive detects <i>STPo</i> after it is more than the value of <i>L8-51</i> [STPo I Detection Level].</p>	1.0 s (1.0 - 10.0 s)

■ L8-54: STPo Id Diff Detection

No. (Hex.)	Name	Description	Default (Range)
L8-54 (0474) Expert	STPo Id Diff Detection	<div style="display: flex; justify-content: space-between; align-items: center;"> V/f CL-V/f OLV CLV AOLV OLV/PM AOLV/PM CLV/PM EZOLV </div> <p>Sets the Id deviation detection function for <i>STPo</i> [Motor Step-Out Detected].</p>	1 (0, 1)

0 : Disabled

1 : Enabled

■ L8-55: Internal DB TransistorProtection

No. (Hex.)	Name	Description	Default (Range)
L8-55 (045F)	Internal DB TransistorProtection	<div style="display: flex; justify-content: space-between; align-items: center;"> V/f CL-V/f OLV CLV AOLV OLV/PM AOLV/PM CLV/PM EZOLV </div> <p>Sets the protection function for the internal braking transistor.</p>	1 (0, 1)

0 : Disable

Disables braking transistor protection.

Use this setting, if enabling the braking transistor can cause an *rF* [Braking Resistor Fault] in these conditions:

- With a regenerative converter, for example D1000.
- With a regenerative unit, for example R1000.
- When connecting braking resistor options to the drive, for example CDBR units.

- Without an internal braking transistor.

1 : Protection Enabled

Protects internal braking transistor when using a braking transistor or optional braking resistors.

These models have a built-in braking transistor:

- 2004 to 2138
- 4002 to 4168

■ L8-56: Stall P @ Accel Activation Time

No. (Hex.)	Name	Description	Default (Range)
L8-56 (047D) Expert	Stall P @ Accel Activation Time	<div style="display: flex; justify-content: space-between; font-size: small;"> V/f CL-V/f OLV CLV AOLV OLV/PM AOLV/PM CLV/PM EZOLV </div> <p>Sets the length time that the acceleration stall prevention function can continue to operate before the drive detects an <i>STPo</i> [Motor Step-Out Detected].</p>	5000 ms (100 - 5000 ms)

Note:

If this value is too small, it can cause incorrect detection of *STPo*. If this value is too large, the drive will not detect *STPo*.

■ L8-57: Stall Prevention Retry Counts

No. (Hex.)	Name	Description	Default (Range)
L8-57 (047E) Expert	Stall Prevention Retry Counts	<div style="display: flex; justify-content: space-between; font-size: small;"> V/f CL-V/f OLV CLV AOLV OLV/PM AOLV/PM CLV/PM EZOLV </div> <p>Sets the number of times the acceleration stall prevention function can operate until speeds agree before the drive detects an <i>STPo</i> [Motor Step-Out Detected].</p>	10 (1 - 10 times)

Note:

If this value is too small, it can cause incorrect detection of *STPo*. If this value is too large, the drive will not detect *STPo*.

■ L8-90: STPo Detection Level (Low Speed)

No. (Hex.)	Name	Description	Default (Range)
L8-90 (0175) Expert	STPo Detection Level (Low Speed)	<div style="display: flex; justify-content: space-between; font-size: small;"> V/f CL-V/f OLV CLV AOLV OLV/PM AOLV/PM CLV/PM EZOLV </div> <p>Sets the detection level that the control fault must be equal to or more than to cause an <i>STPo</i> [Motor Step-Out Detected].</p>	Determined by A1-02 (0 - 5000 times)

This function detects when PM motors are not synchronized.

The drive cannot detect when motors are not synchronized because the frequency reference is low during start up and the motor is locked. If fault detection is necessary in these conditions, set the control fault detection level to enable detection of desynchronization because of motor locking. Increase the setting in 5-unit increments.

■ L8-93: Low Speed Pull-out DetectionTime

No. (Hex.)	Name	Description	Default (Range)
L8-93 (073C) Expert	Low Speed Pull-out DetectionTime	<div style="display: flex; justify-content: space-between; font-size: small;"> V/f CL-V/f OLV CLV AOLV OLV/PM AOLV/PM CLV/PM EZOLV </div> <p>Sets the length of time the drive will wait to start baseblock after detecting <i>LSo</i> [Low Speed Motor Step-Out].</p>	1.0 s (0.0 - 10.0 s)

Set this parameter to 0.0 to disable the function.

■ L8-94: Low Speed Pull-out Detect Level

No. (Hex.)	Name	Description	Default (Range)
L8-94 (073D) Expert	Low Speed Pull-out Detect Level	<div style="display: flex; justify-content: space-between; font-size: small;"> V/f CL-V/f OLV CLV AOLV OLV/PM AOLV/PM CLV/PM EZOLV </div> <p>Sets the detection level for <i>LSo</i> [Low Speed Motor Step-Out] as a percentage of <i>E1-04</i> [Maximum Output Frequency].</p>	3% (0 - 10%)

■ L8-95: Low Speed Pull-out Amount

No. (Hex.)	Name	Description	Default (Range)
L8-95 (077F) Expert	Low Speed Pull-out Amount	<div style="display: flex; justify-content: space-between; font-size: 0.8em; margin-bottom: 5px;"> V/f CL-V/f OLV CLV AOLV OLV/PM AOLV/PM CLV/PM EZOLV </div> Sets the average count of <i>LSo</i> [Low Speed Motor Step-Out] detections.	10 (1 - 50 times)

◆ L9: Drive Protection 2

L9 parameters are used to configure the protection function used to detect cooling fan faults.

■ L9-16: FAn1 Detect Time

No. (Hex.)	Name	Description	Default (Range)
L9-16 (11DC) Expert	FAn1 Detect Time	<div style="display: flex; justify-content: space-between; font-size: 0.8em; margin-bottom: 5px;"> V/f CL-V/f OLV CLV AOLV OLV/PM AOLV/PM CLV/PM EZOLV </div> Sets the detection time for <i>FAn1</i> [Drive Cooling Fan Fault]. Yaskawa recommends that you do not change this parameter value.	4.0 s (0.0 - 30.0 s)

12.10 n: Special Adjustment

n parameters set these functions:

- Function to prevent hunting
- High-slip braking
- Motor line-to-line resistance online tuning
- Fine-tune the parameters that adjust motor control

◆ n1: Hunting Prevention

The Hunting Prevention function will not let low inertia or operation with a light load cause hunting. Hunting frequently occurs when you have a high carrier frequency and an output frequency less than 30 Hz.

■ n1-01: Hunting Prevention Selection

No. (Hex.)	Name	Description	Default (Range)
n1-01 (0580)	Hunting Prevention Selection	<input type="checkbox"/> V/f <input type="checkbox"/> CL-V/f <input type="checkbox"/> OLV <input type="checkbox"/> CLV <input type="checkbox"/> AOLV <input type="checkbox"/> OLV/PM <input type="checkbox"/> AOLV/PM <input type="checkbox"/> CLV/PM <input type="checkbox"/> EZOLV Sets the function to prevent hunting.	Determined by o2-04 (0 to 2)

When drive response is more important than the decrease of motor vibration, disable this function.

If hunting occurs, or if you use a high carrier frequency or SwingPWM, set this parameter to 2 for better hunting prevention.

0 : Disabled

1 : Enabled (Normal)

2 : Enabled (High Carrier Frequency)

■ n1-02: Hunting Prevention Gain Setting

No. (Hex.)	Name	Description	Default (Range)
n1-02 (0581) Expert	Hunting Prevention Gain Setting	<input type="checkbox"/> V/f <input type="checkbox"/> CL-V/f <input type="checkbox"/> OLV <input type="checkbox"/> CLV <input type="checkbox"/> AOLV <input type="checkbox"/> OLV/PM <input type="checkbox"/> AOLV/PM <input type="checkbox"/> CLV/PM <input type="checkbox"/> EZOLV Sets the performance of the hunting prevention function. Usually it is not necessary to change this parameter.	1.00 (0.00 - 2.50)

Adjust this parameter in these conditions:

- When $n1-01 = 1, 2$ [*Hunting Prevention Selection = Enabled (Normal), Enabled (High Carrier Frequency)*]: If oscillation occurs when you operate a motor with a light load, increase the setting value in 0.1-unit increments.
- When $n1-01 = 1, 2$, if the motor stalls: Decrease the setting value in 0.1-unit increments.

■ n1-03: Hunting Prevention Time Constant

No. (Hex.)	Name	Description	Default (Range)
n1-03 (0582) Expert	Hunting Prevention Time Constant	<input type="checkbox"/> V/f <input type="checkbox"/> CL-V/f <input type="checkbox"/> OLV <input type="checkbox"/> CLV <input type="checkbox"/> AOLV <input type="checkbox"/> OLV/PM <input type="checkbox"/> AOLV/PM <input type="checkbox"/> CLV/PM <input type="checkbox"/> EZOLV Sets the primary delay time constant of the hunting prevention function. Usually it is not necessary to change this parameter.	Determined by o2-04 (0 - 500 ms)

Adjust this parameter in these conditions:

- Load inertia is large: Increase the setting value. If the setting value is too high, response will be slower. Also, there will be oscillation when the frequency is low.
- Oscillation occurs at low frequencies: Decrease the setting value.

■ n1-05: Hunting Prevent Gain in Reverse

No. (Hex.)	Name	Description	Default (Range)
n1-05 (0530) Expert	Hunting Prevent Gain in Reverse	<input type="checkbox"/> V/f <input type="checkbox"/> CL-V/f <input type="checkbox"/> OLV <input type="checkbox"/> CLV <input type="checkbox"/> AOLV <input type="checkbox"/> OLV/PM <input type="checkbox"/> AOLV/PM <input type="checkbox"/> CLV/PM <input type="checkbox"/> EZOLV Sets the performance of the hunting prevention function. This parameter adjusts Reverse run. Usually it is not necessary to change this parameter.	0.00 (0.00 - 2.50)

Note:

When you set this parameter to 0, the value set in *n1-02 [Hunting Prevention Gain Setting]* is effective when the motor rotates in reverse.

Adjust this parameter in these conditions:

- When *n1-01 = 1, 2 [Hunting Prevention Selection = Enabled (Normal), Enabled (High Carrier Frequency)]*: If oscillation occurs when you operate a motor with a light load, increase the setting value in 0.1-unit increments.
- When *n1-01 = 1, 2*, if the motor stalls: Decrease the setting value in 0.1-unit increments.

■ n1-08: Current Detection Method

No. (Hex.)	Name	Description	Default (Range)
n1-08 (1105) Expert	Current Detection Method	<input checked="" type="checkbox"/> V/f <input checked="" type="checkbox"/> CL-V/f <input type="checkbox"/> OLV <input type="checkbox"/> CLV <input type="checkbox"/> AOLV <input type="checkbox"/> OLV/PM <input type="checkbox"/> AOLV/PM <input type="checkbox"/> CLV/PM <input type="checkbox"/> EZOLV Sets how the drive decreases the motor vibration that is caused by leakage current. Usually it is not necessary to change this parameter.	0 (0, 1)

0 : 2-Phases

1 : 3-Phases

Note:

Set this parameter to 1 to suppress motor vibrations caused by leakage current when the wiring distance is long.

■ n1-13: DC Bus Stabilization Control

No. (Hex.)	Name	Description	Default (Range)
n1-13 (1B59) Expert	DC Bus Stabilization Control	<input checked="" type="checkbox"/> V/f <input checked="" type="checkbox"/> CL-V/f <input type="checkbox"/> OLV <input type="checkbox"/> CLV <input type="checkbox"/> AOLV <input type="checkbox"/> OLV/PM <input type="checkbox"/> AOLV/PM <input type="checkbox"/> CLV/PM <input type="checkbox"/> EZOLV Sets the oscillation suppression function for the DC bus voltage.	0 (0, 1)

0 : Disabled

1 : Enabled

Note:

If the DC bus voltage does not become stable with light loads and the drive detects *ov [Overvoltage]*, set this parameter to 1.

■ n1-14: DC Bus Stabilization Time

No. (Hex.)	Name	Description	Default (Range)
n1-14 (1B5A) Expert	DC Bus Stabilization Time	<input checked="" type="checkbox"/> V/f <input checked="" type="checkbox"/> CL-V/f <input type="checkbox"/> OLV <input type="checkbox"/> CLV <input type="checkbox"/> AOLV <input type="checkbox"/> OLV/PM <input type="checkbox"/> AOLV/PM <input type="checkbox"/> CLV/PM <input type="checkbox"/> EZOLV Adjusts the responsiveness of the oscillation suppression function for the DC bus voltage. Set <i>n1-13 = 1 [DC Bus Stabilization Control = Enabled]</i> to enable this parameter.	100.0 ms (50.0 - 500.0 ms)

Note:

Adjust this parameter in 100 ms increments.

■ n1-15: PWM Voltage Offset Calibration

No. (Hex.)	Name	Description	Default (Range)
n1-15 (0BF8) Expert	PWM Voltage Offset Calibration	<input checked="" type="checkbox"/> V/f <input checked="" type="checkbox"/> CL-V/f <input type="checkbox"/> OLV <input type="checkbox"/> CLV <input type="checkbox"/> AOLV <input type="checkbox"/> OLV/PM <input type="checkbox"/> AOLV/PM <input type="checkbox"/> CLV/PM <input type="checkbox"/> EZOLV Sets the calibration method that the drive uses to decrease torque/current ripple.	Determined by A1-02 (0 - 2)

This calibration function lets the drive suppress the torque ripple of a motor. Usually it is not necessary to change this setting.

0 : No Calibration

1 : One Time Calibrate at Next Start

2 : Calibrate Every Time at Start

■ **n1-16: Hunting Prevention High Fc Gain**

No. (Hex.)	Name	Description	Default (Range)
n1-16 (0BFB)	Hunting Prevention High Fc Gain	<div style="display: flex; justify-content: space-between; align-items: center;"> V/f CL-V/f OLV CLV AOLV OLV/PM AOLV/PM CLV/PM EZOLV </div> <p>Sets the gain for the hunting prevention function. This parameter functions best with a high carrier frequency. Usually it is not necessary to change this parameter.</p>	Determined by o2-04 (0.00 - 2.50)

Set $n1-01 = 2$ [*Hunting Prevention Selection = Enabled (High Carrier Frequency)*] to enable this function.

If the motor oscillates, set $n1-01 = 2$. If that does not have an effect, increase this parameter in 0.2-unit increments.

■ **n1-17: Hunting Prevent High Fc Filter**

No. (Hex.)	Name	Description	Default (Range)
n1-17 (0BFC) Expert	Hunting Prevent High Fc Filter	<div style="display: flex; justify-content: space-between; align-items: center;"> V/f CL-V/f OLV CLV AOLV OLV/PM AOLV/PM CLV/PM EZOLV </div> <p>Sets the responsiveness of the hunting prevention function. Usually it is not necessary to change this parameter.</p>	500 ms (0 - 1000 ms)

When $n1-01 = 2$ [*Hunting Prevention Selection = Enabled (High Carrier Frequency)*], if the motor stalls when the load changes, increase the value set in this parameter in 100 ms increments.

If you set $n1-01 = 2$ and you cannot suppress hunting, increase the value set in this parameter in 100 ms increments.

■ **n1-20: Voltage Calibration Duration**

No. (Hex.)	Name	Description	Default (Range)
n1-20 (1588) Expert	Voltage Calibration Duration	<div style="display: flex; justify-content: space-between; align-items: center;"> V/f CL-V/f OLV CLV AOLV OLV/PM AOLV/PM CLV/PM EZOLV </div> <p>Sets the calibration time at start. Usually it is not necessary to change this parameter.</p>	50 ms (10 - 500 ms)

◆ **n2: Auto Freq Regulator (AFR)**

The speed feedback detection reduction function (or AFR: Automatic Frequency Regulator) helps the speed become stable when you suddenly apply or remove a load.

Note:

Before you change *n2-xx parameters*, do one of these procedures:

- Set the motor parameters and V/f pattern correctly.
- Do Rotational Auto-Tuning.

■ **n2-01: Automatic Freq Regulator Gain**

No. (Hex.)	Name	Description	Default (Range)
n2-01 (0584)	Automatic Freq Regulator Gain	<div style="display: flex; justify-content: space-between; align-items: center;"> V/f CL-V/f OLV CLV AOLV OLV/PM AOLV/PM CLV/PM EZOLV </div> <p>Sets the gain of the AFR function as a magnification value. Usually it is not necessary to change this setting.</p>	1.00 (0.00 - 10.00)

Adjust this parameter in these conditions:

- If hunting or oscillation occurs with light loads, increase the setting value in 0.05-unit increments and examine the response.
- When torque is not sufficient with heavy loads or to make the torque or speed response better, decrease the setting value in 0.05-unit increments and examine the response.

■ **n2-02: Automatic Freq Regulator Time 1**

No. (Hex.)	Name	Description	Default (Range)
n2-02 (0585)	Automatic Freq Regulator Time 1	<div style="display: flex; justify-content: space-between; align-items: center;"> V/f CL-V/f OLV CLV AOLV OLV/PM AOLV/PM CLV/PM EZOLV </div> <p>Sets the time constant that sets the rate of change for the AFR function. Usually it is not necessary to change this setting.</p>	50 ms (0 - 2000 ms)

Adjust this parameter in these conditions:

- If there is hunting or oscillation with a light load, increase the setting value in 50 ms increments and examine the response. If the load inertia is large, increase the setting value in 50 ms increments and examine the response.
- If torque is not sufficient with a heavy load or if you must increase torque or speed responsiveness, decrease the setting value in 10 ms increments and examine the response.

Note:

- Set $n2-02 \leq n2-03$ [Automatic Freq Regulator Time 2]. If $n2-02 > n2-03$, the drive will detect *oPE08* [Parameter Selection Error].
- When you change the value in *n2-02*, also change the value in *C4-02* [Torque Compensation Delay Time] by the same ratio.

■ n2-03: Automatic Freq Regulator Time 2

No. (Hex.)	Name	Description	Default (Range)
n2-03 (0586)	Automatic Freq Regulator Time 2	<div style="display: flex; justify-content: space-between; font-size: small;"> V/f CL-V/f OLV CLV AOLV OLV/PM AOLV/PM CLV/PM EZOLV </div> <p>Sets the time constant that sets the speed difference of the AFR function. Use this parameter for speed searches or regeneration. Usually it is not necessary to change this setting.</p>	750 ms (0 - 2000 ms)

Adjust this parameter in these conditions:

- If the drive detects *ov* [Overvoltage] when acceleration stops under high-inertia loads, increase the setting value in 50 ms increments.
If the drive detects *ov* when the load changes suddenly, increase the setting value in 50 ms increments.
- To increase the responsiveness of torque and speed, decrease the setting value in 10 ms increments and examine the response.

Note:

- Set $n2-02 \leq n2-03$ [Automatic Freq Regulator Time 2]. If $n2-02 > n2-03$, the drive will detect *oPE08* [Parameter Selection Error].
- When you change the value in *n2-03*, also change the value in *C4-06* [Motor 2 Torque Comp Delay Time] by the same ratio.

◆ n3: High Slip Braking (HSB) and Overexcitation Braking

n3 parameters configure High Slip Braking and Overexcitation Deceleration.

■ High Slip Braking

High slip braking quickly decelerates motors without braking resistors.

This lets you stop a motor more quickly than with the ramp to stop processes. This function is best for applications that do not frequently stop the motor, for example the fast stop function for high-inertia loads. Braking starts when the MFDI for *High Slip Braking (HSB) Activate* [*H1-xx = 68*] activates.

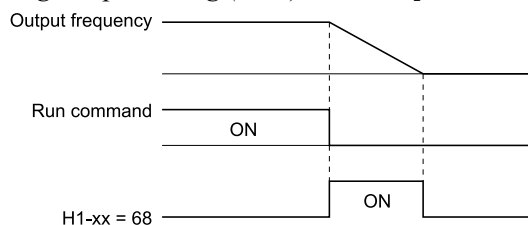

Figure 12.146 High Slip Braking Time Chart

An induction motor is necessary to use high slip braking. Set *A1-02* [Control Method Selection] to one of these values to enable high slip braking:

- 0 [V/f Control]
- 1 [V/f Control with Encoder]

Principles of Operation

HSB increases motor slip by significantly decreasing the frequency supplied to the motor at the same time that deceleration starts. A large quantity of current flows through the motor to increase the motor loss, and the motor decelerates while the motor windings consume the regenerative energy.

The drive keeps the motor current at a constant level during deceleration to prevent *oC* [Overcurrent] and *ov* [Overvoltage] and do automatic braking. It also keeps a slip level that causes the maximum quantity of deceleration torque.

High Slip Braking Precautions

- Do not use the high slip braking function in these applications:
 - Frequent deceleration

- Deceleration time differences
- Continuous regenerative loads
- It is necessary to accelerate again during deceleration
- Motor loss increases during high slip braking. Use this function when the duty time factor is 5% ED or less and the braking time is 90 seconds or less. The load inertia and motor characteristics have an effect on the braking time.
- The drive ignores the configured deceleration time during high slip braking. To stop motors in the configured deceleration time, set $L3-04 = 4$ [Stall Prevention during Decel = Overexcitation/High Flux].
- You cannot use high slip braking to decelerate deceleration at user-defined speeds. To decelerate at user-defined speeds, use the overexcitation deceleration function.
- You cannot accelerate the motor again during high slip braking until you fully stop the motor and input the Run command again.
- You cannot use high slip braking and the KEB Ride-Thru function at the same time. If you enable those two functions, the drive will detect $oPE03$ [Multi-Function Input Setting Err].

Overexcitation Deceleration

Overexcitation deceleration quickly decelerates motors without braking resistors.

This lets you stop a motor more quickly than with the ramp to stop processes.

Overexcitation deceleration increases excitation current during deceleration to cause a large quantity of braking torque through motor overexcitation. You can set the deceleration speed to adjust the deceleration time for overexcitation deceleration.

Overexcitation deceleration lets you accelerate the motor again during deceleration.

Enter the Run command during overexcitation deceleration to cancel overexcitation deceleration and accelerate the drive to the specified speed.

To enable this function, set $L3-04 = 4, 5$ [Stall Prevention during Decel = Overexcitation/High Flux, Overexcitation/High Flux 2].

When $L3-04 = 4$, the motor will decelerate for the deceleration time set in $C1-02, C1-04, C1-06, or C1-08$. If the drive detects ov [Overvoltage], increase the deceleration time.

When $L3-04 = 5$, the drive uses the value in $C1-02, C1-04, C1-06, or C1-08$ to decelerate and it adjusts the deceleration rate to keep the DC bus voltage at the level set in $L3-17$ [DC Bus Regulation Level]. The load inertia and motor characteristics have an effect on the braking time.

Notes on Overexcitation Deceleration

- Do not use Overexcitation Deceleration with a braking resistor.
- Do not use Overexcitation Deceleration for these applications. Connect a braking resistor to the drive as an alternative to Overexcitation Deceleration.
 - Frequent sudden decelerations
 - Continuous regenerative loads
 - Low inertia machines
 - Machines that have no tolerance for torque ripples
- Motor loss increases during overexcitation deceleration. Use this function when the duty time factor is 5% ED or less and the braking time is 90 seconds or less. The load inertia and motor characteristics have an effect on the braking time. You can use overexcitation deceleration in OLV control and CLV control, but those control methods decrease the precision of torque control and braking efficiency. Use V/f control for the best results.
- The drive disables these functions during braking with Overexcitation Deceleration 2:
 - Hunting Prevention Function (V/f Control)
 - Torque Limit Speed Control (OLV Control)

n3-01: HSB Deceleration Frequency Width

No. (Hex.)	Name	Description	Default (Range)
n3-01 (0588) Expert	HSB Deceleration Frequency Width	<div style="display: flex; justify-content: space-between; font-size: small;"> V/f CL-V/f OLV CLV AOLV OLV/IPM AOLV/IPM CLV/IPM EZOLV </div> <p>Sets the amount by which the output frequency is to be lowered during high-slip braking, as a percentage of $E1-04$ [Maximum Output Frequency], which represents the 100% value.</p>	5% (1 - 20%)

When you must detect *ov* [DC Bus Overvoltage] during high-slip braking, set this parameter to a large value.

■ n3-02: HSB Current Limit Level

No. (Hex.)	Name	Description	Default (Range)
n3-02 (0589) Expert	HSB Current Limit Level	V/f CL-V/f OLV CLV AOLV OLV/PM AOLV/PM CLV/PM EZOLV Sets the maximum current output during high-slip braking as a percentage, where <i>E2-01</i> [Motor Rated Current (FLA)] is 100%. Also set the current suppression to prevent exceeding drive overload tolerance.	Determined by C6-01 and L8-38 (0 - 150%)

Note:

The upper limit of the setting range changes when the setting for *C6-01* [Normal / Heavy Duty Selection] changes.

- 150% when *C6-01* = 0 [Heavy Duty Rating 1 (HD1) for Constant Torque Applications].
- 110% when *C6-01* = 1 [Normal Duty Rating 1 (ND1) for Variable Torque Applications].

When you decrease the setting value for current suppression, it will make the deceleration time longer.

- When you must detect *ov* [DC Bus Overvoltage] during high-slip braking, set this parameter to a low value.
- If the motor current increases during high-slip braking, decrease the setting value to prevent burn damage in the motor.
- The overload tolerance for the drive is 150% for Heavy Duty Rating (HD) and 110% for Normal Duty Rating (ND).

■ n3-03: HSB Dwell Time at Stop

No. (Hex.)	Name	Description	Default (Range)
n3-03 (058A) Expert	HSB Dwell Time at Stop	V/f CL-V/f OLV CLV AOLV OLV/PM AOLV/PM CLV/PM EZOLV Sets the dwell time, a length of time when high-slip braking is ending and during which the motor speed decreases and runs at a stable speed. For a set length of time, the drive will hold the actual output frequency at the minimum output frequency set in <i>E1-09</i> .	1.0 s (0.0 - 10.0 s)

If there is too much inertia or when the motor is coasting to a stop after high-slip braking is complete, increase the setting value. If the setting value is too low, machine inertia can cause the motor to rotate after high-slip braking is complete.

■ n3-04: HSB Overload Time

No. (Hex.)	Name	Description	Default (Range)
n3-04 (058B) Expert	HSB Overload Time	V/f CL-V/f OLV CLV AOLV OLV/PM AOLV/PM CLV/PM EZOLV Sets the time used to detect <i>oL7</i> [High Slip Braking Overload], which occurs when the output frequency does not change during high-slip braking. Usually it is not necessary to change this parameter.	40 s (30 - 1200 s)

If a force on the load side is rotating the motor or if there is too much load inertia connected to the motor, the drive will detect *oL7*.

The current flowing to the motor from the load can overheat the motor and cause burn damage to the motor. Set this parameter to prevent burn damage to the motor.

■ n3-13: OverexcitationBraking (OEB) Gain

No. (Hex.)	Name	Description	Default (Range)
n3-13 (0531)	OverexcitationBraking (OEB) Gain	V/f CL-V/f OLV CLV AOLV OLV/PM AOLV/PM CLV/PM EZOLV Sets the gain value that the drive multiplies by the V/f pattern output value during overexcitation deceleration to calculate the overexcitation level.	1.10 (1.00 - 1.40)

The V/f pattern output value goes back to its usual level after the motor stops or accelerates again to the frequency reference speed.

The best value of this parameter changes when the flux saturation characteristics of the motor change.

- Gradually increase the value of *n3-13* to 1.25 or 1.30 to increase the braking power of Overexcitation Deceleration. If the gain is too much, the motor can have flux saturation and cause a large quantity of current to flow.
- This can increase the deceleration time. Decrease the setting value if flux saturation causes overcurrent. If you increase the setting value, the drive can detect *oC* [Overcurrent], *oL1* [Motor Overload], and *oL2* [Drive Overload]. Decrease the value of *n3-21* [HSB Current Suppression Level] to prevent *oC* and *oL*.

- If you use overexcitation deceleration frequently or if you use overexcitation deceleration for an extended period of time, it can increase motor temperature. Decrease the setting value in these conditions.
- If *ov [Overvoltage]* occurs, increase the deceleration time.

■ n3-14: OEB High Frequency Injection

No. (Hex.)	Name	Description	Default (Range)
n3-14 (0532) Expert	OEB High Frequency Injection	V/f CL-V/f OLV CLV AOLV OLV/PM AOLV/PM CLV/PM EZOLV Sets the function that injects harmonic signals during overexcitation deceleration.	0 (0, 1)

Enable this parameter to set a shorter deceleration time.

Note:

- If you frequently use overexcitation deceleration on a motor, the motor loss will increase the risk of burn damage.
- When you set this parameter to 1, the motor can make a loud excitation sound during overexcitation deceleration. If the excitation sound is unwanted, set this parameter to 0 to disable the function.

0 : Disabled

1 : Enabled

The drive injects harmonic signals at the time of overexcitation deceleration. You can decrease the deceleration time because motor loss increases.

■ n3-21: HSB Current Suppression Level

No. (Hex.)	Name	Description	Default (Range)
n3-21 (0579)	HSB Current Suppression Level	V/f CL-V/f OLV CLV AOLV OLV/PM AOLV/PM CLV/PM EZOLV Sets the upper limit of the current that is suppressed at the time of overexcitation deceleration as a percentage of the drive rated current.	100% (0 - 150%)

If flux saturation during Overexcitation Deceleration makes the motor current become more than the value set in *n3-21*, the drive will automatically decrease the overexcitation gain. If *oC [Overcurrent]*, *oL1 [Motor Overload]*, or *oL2 [Drive Overload]* occur during overexcitation deceleration, decrease the setting value.

If repetitive or long overexcitation deceleration cause the motor to overheat, decrease the setting value.

■ n3-23: Overexcitation Braking Operation

No. (Hex.)	Name	Description	Default (Range)
n3-23 (057B)	Overexcitation Braking Operation	V/f CL-V/f OLV CLV AOLV OLV/PM AOLV/PM CLV/PM EZOLV Sets the direction of motor rotation where the drive will enable overexcitation.	0 (0 - 2)

0 : Disabled

1 : Enabled Only when Rotating FWD

2 : Enabled Only when Rotating REV

Note:

When *n3-23 = 1, 2*, the drive enables overexcitation only in the direction of motor rotation in which a regenerative load is applied. Increased motor loss can decrease *ov [Overvoltage]* faults.

◆ n4: Adv Open Loop Vector Tune

To make special adjustments for *Advanced Open Loop [A1-02 = 4]* (AOLV) control, note these items:

- Do Rotational Auto-Tuning first.
- When there is a load, applications must stay constant around zero speed in AOLV control. If the application will not stay constant around zero speed, set *A1-02 = 3 [Closed Loop Vector]*.
- The tolerance of regenerative torque at low speeds decreases in AOLV control. When regenerative torque is necessary in the low speed range, set *A1-02 = 3*.
- You cannot use AOLV control in elevators or other lifting applications because there is a risk that the load could slip.
- If you operate the drive at a frequency lower than *n4-70 [Speed Command Comp @ Low Freq]* (default setting: 1.00 Hz), the motor can rotate at a frequency that is approximately 1/2 of the *n4-70* setting. Set *E1-09 [Minimum Output Frequency] > 0* to not let the motor to rotate at a lower frequency than the *n4-70* setting. When the frequency reference $\leq E1-09$, the drive output will turn OFF.

■ n4-60: Motoring Low Speed Comp Gain

No. (Hex.)	Name	Description	Default (Range)
n4-60 (1B80)	Motoring Low Speed Comp Gain	V/f CL-V/f OLV CLV AOLV OLV/PM AOLV/PM CLV/PM EZOLV Sets a compensation gain to improve the control qualities for motoring loads in the low speed range.	100.0 % (50.0 - 200.0%)

Note:

- To improve torque accuracy in the motoring direction when running at low speeds, either perform only Stationary Auto-Tuning for Line-to-Line Resistance, or increase the setting value in 5% increments. The recommended setting is 100% to 120%.
- If the output frequency changes when you operate at low speeds, do Stationary Auto-Tuning for Line-to-Line Resistance only. If it is not better, increase this parameter in 10% increments. The recommended setting is 50% to 100%.

■ n4-61: Low Speed Comp Frequency Level

No. (Hex.)	Name	Description	Default (Range)
n4-61 (1B81)	Low Speed Comp Frequency Level	V/f CL-V/f OLV CLV AOLV OLV/PM AOLV/PM CLV/PM EZOLV Sets a frequency at which the settings n4-60 [Motoring Low Speed Comp Gain] and n4-62 [Regen Low Speed Comp Gain] are enabled. When the output frequency < n4-61, the drive adjusts the torque to agree with the settings for n4-60 and n4-62. Usually it is not necessary to change this setting.	6.00 Hz (0.50 - 12.00 Hz)

■ n4-62: Regen Low Speed Comp Gain

No. (Hex.)	Name	Description	Default (Range)
n4-62 (1B82)	Regen Low Speed Comp Gain	V/f CL-V/f OLV CLV AOLV OLV/PM AOLV/PM CLV/PM EZOLV Sets a compensation gain to improve the control qualities for regenerative loads in the low speed range.	100.0 % (50.0 - 500.0%)

Note:

If you do not apply a regenerative load when you operate at low speeds, do stationary Auto-Tuning for Line-to-Line Resistance only. If this does not make it better, increase the setting value in 5% increments. The recommended setting is 100% to 150%. If you set this parameter too high, the drive will detect CF [Control Fault] at stop.

■ n4-63: Speed EstimateResponse@High Freq

No. (Hex.)	Name	Description	Default (Range)
n4-63 (1B83)	Speed EstimateResponse@High Freq	V/f CL-V/f OLV CLV AOLV OLV/PM AOLV/PM CLV/PM EZOLV Sets the responsiveness of the speed estimation in high speed ranges, where the output frequency is \geq n4-67 [Estimate Gain Switchover Freq].	60.0 (0.1 - 300.0)

If better response of speed estimation is necessary, or if the motor oscillates, or if there is a large quantity of torque ripple, increase the setting value in 10.0 unit increments. If this does not make it better, decrease the setting value in 10.0 unit increments.

Note:

Do rotational Auto-Tuning before you adjust n4-63, n4-64 [Speed Estimate Response@Low Freq], n4-65 [Flux Estimate Response@High Freq], and n4-66 [Flux Estimate Response @Low Freq].

■ n4-64: Speed Estimate Response@Low Freq

No. (Hex.)	Name	Description	Default (Range)
n4-64 (1B84)	Speed Estimate Response@Low Freq	V/f CL-V/f OLV CLV AOLV OLV/PM AOLV/PM CLV/PM EZOLV Sets the responsiveness of the speed estimation in low speed ranges, where $0 \leq$ the output frequency, which is < n4-67 [Estimate Gain Switchover Freq].	60.0 (0.1 - 300.0)

If better response of speed estimation is necessary, or if the motor oscillates, or if there is a large quantity of torque ripple, increase the setting value in 10.0 unit increments.

Note:

Do rotational Auto-Tuning before you adjust n4-63 [Speed EstimateResponse@High Freq], n4-64, n4-65 [Flux Estimate Response@High Freq], and n4-66 [Flux Estimate Response @Low Freq].

■ n4-65: Flux Estimate Response@High Freq

No. (Hex.)	Name	Description	Default (Range)
n4-65 (1B85)	Flux Estimate Response@High Freq	<div style="display: flex; justify-content: space-between; align-items: center;"> V/f CL-V/f OLV CLV AOLV OLV/PM AOLV/PM CLV/PM EZOLV </div> <p>Sets the responsiveness of the magnetic flux estimation in high speed ranges, where the output frequency is $\geq n4-67$ [Estimate Gain Switchover Freq]. Usually it is not necessary to change this setting.</p>	1.00 (0.50 - 3.00)

If the drive detects *oS* [Overspeed] in no-load conditions, or if the speed does not become stable in the high speed range, increase or decrease the setting value in 0.05 unit increments.

■ n4-66: Flux Estimate Response @Low Freq

No. (Hex.)	Name	Description	Default (Range)
n4-66 (1B86)	Flux Estimate Response @Low Freq	<div style="display: flex; justify-content: space-between; align-items: center;"> V/f CL-V/f OLV CLV AOLV OLV/PM AOLV/PM CLV/PM EZOLV </div> <p>Sets the responsiveness of the magnetic flux estimation in low speed ranges, where $0 \leq$ the output frequency, which is $< n4-67$ [Estimate Gain Switchover Freq]. Usually it is not necessary to change this setting.</p>	1.50 (0.50 - 3.00)

If the drive detects *oS* [Overspeed] in no-load conditions, or if the speed does not become stable in the low speed range, increase or decrease the setting value in 0.05 unit increments.

■ n4-67: Estimate Gain Switchover Freq

No. (Hex.)	Name	Description	Default (Range)
n4-67 (1B87)	Estimate Gain Switchover Freq	<div style="display: flex; justify-content: space-between; align-items: center;"> V/f CL-V/f OLV CLV AOLV OLV/PM AOLV/PM CLV/PM EZOLV </div> <p>Sets the switching frequency for estimation gain for these parameters: <i>n4-63</i> [Speed EstimateResponse@High Freq] <i>n4-64</i> [Speed Estimate Response@Low Freq] <i>n4-65</i> [Flux Estimate Response@High Freq] <i>n4-66</i> [Flux Estimate Response @Low Freq] Usually it is not necessary to change this setting.</p>	6.00 Hz (0.00 - E1-04 setting)

When the output frequency $\geq n4-67$, the drive will select *n4-63* and *n4-65*. When the output frequency $< n4-67$, the drive will select *n4-64* and *n4-66*.

■ n4-68: Speed Estimation Filter Time

No. (Hex.)	Name	Description	Default (Range)
n4-68 (1B88)	Speed Estimation Filter Time	<div style="display: flex; justify-content: space-between; align-items: center;"> V/f CL-V/f OLV CLV AOLV OLV/PM AOLV/PM CLV/PM EZOLV </div> <p>Sets the primary delay time constant for the speed estimation value. Usually it is not necessary to change this setting.</p>	0.001 s (0.001 - 0.010 s)

If the motor speed oscillates in the high speed range, set the value to 0.010 s.

■ n4-69: Flux Control Response

No. (Hex.)	Name	Description	Default (Range)
n4-69 (1B89)	Flux Control Response	<div style="display: flex; justify-content: space-between; align-items: center;"> V/f CL-V/f OLV CLV AOLV OLV/PM AOLV/PM CLV/PM EZOLV </div> <p>Unifies control of magnetic flux to make motor vibrations more stable.</p>	1.00 (0.00 - 60.00)

If step-out occurs when the load changes, decrease the setting value in 1.00 increments.

Note:

If heavy loads decrease motor speed, increase the setting value in 1.00 increments. If it does not get better, increase *n4-74* [Limit of Flux Loop] in 20% increments.

■ n4-70: Speed Command Comp @ Low Freq

No. (Hex.)	Name	Description	Default (Range)
n4-70 (1B8A)	Speed Command Comp @ Low Freq	<div style="display: flex; justify-content: space-between; align-items: center;"> V/f CL-V/f OLV CLV AOLV OLV/PM AOLV/PM CLV/PM EZOLV </div> <p>Sets the function to make the drive more stable when operating at low speeds. Usually it is not necessary to change this setting.</p>	1.00 Hz (0.00 - 6.00 Hz)

This function makes the control more stable when you operate at low speeds.

- If the load is light when the drive operates in the low speed range, increase the setting value in 0.3 Hz increments.

Note:

Increase the setting value to increase the stability when the drive is operating at low speed. It can make the speed control less accurate.

- When the motor rotates faster than the frequency reference at low speed, decrease the setting value in 0.1 Hz increments.

Note:

If you set the value too low, the motor can rotate in reverse.

■ n4-71: Flux Estimation Method

No. (Hex.)	Name	Description	Default (Range)
n4-71 (1B8B) Expert	Flux Estimation Method	<div style="display: flex; justify-content: space-between; font-size: small;"> V/f CL-V/f OLV CLV AOLV OLV/PM AOLV/PM CLV/PM EZOLV </div> Sets the flux estimation method. Usually it is not necessary to change this setting.	0 (0, 1)

0 : Method 1

1 : Method 2

■ n4-72: Speed Feedback Mode

No. (Hex.)	Name	Description	Default (Range)
n4-72 (1B8C)	Speed Feedback Mode	<div style="display: flex; justify-content: space-between; font-size: small;"> V/f CL-V/f OLV CLV AOLV OLV/PM AOLV/PM CLV/PM EZOLV </div> Sets the requirement for an encoder option when $A1-02 = 4$ [Control Method Selection = Advanced Open Loop Vector].	0 (0, 1)

You can connect a PG-B3 or PG-X3 encoder option in AOLV control. You can use the encoder option for better speed control precision.

Note:

- When you use an encoder option in AOLV control to operate machinery, specialized tuning of the drive can be necessary. You should usually set $A1-02 = 3$ [Control Method Selection = Closed Loop Vector] when you use an encoder option.
- When you set this parameter to 1, also set the number of PG pulses in $F1-01$ [Encoder 1 Pulse Count (PPR)].

0 : Without Encoder

1 : With Encoder

■ n4-73: PGo Recovery Selection

No. (Hex.)	Name	Description	Default (Range)
n4-73 (1B8D)	PGo Recovery Selection	<div style="display: flex; justify-content: space-between; font-size: small;"> V/f CL-V/f OLV CLV AOLV OLV/PM AOLV/PM CLV/PM EZOLV </div> Sets the restart mode to Without Encoder Mode or the With Encoder Mode when an encoder is disconnected.	0 (0, 1)

Set $A1-02 = 4$ [Control Method Selection = AOLV] and $n4-72 = 1$ [Speed Feedback Mode = With Encoder] to use this parameter.

Parameter $F1-02$ [Encoder Signal Loss Detect Sel] sets the drive response when the drive detects a disconnected encoder. This parameter sets the drive to start up in the Without Encoder Mode or With Encoder Mode if the drive detects PGo [Encoder (PG) Feedback Loss].

Note:

A PG-B3 encoder option is necessary to use this parameter. When you use a PG-X3 option, it is not necessary to set this parameter.

If the drive detects PGo, de-energize the drive and examine the wiring for the encoder.

0 : Without Encoder

1 : With Encoder

■ n4-74: Limit of Flux Loop

No. (Hex.)	Name	Description	Default (Range)
n4-74 (1B8E)	Limit of Flux Loop	<div style="display: flex; justify-content: space-between; font-size: small;"> V/f CL-V/f OLV CLV AOLV OLV/PM AOLV/PM CLV/PM EZOLV </div> Sets the control level for flux loop control output.	250% (100 - 500%)

If the torque is not sufficient because of 100% or more loads, increase the setting value in 20% increments. If the setting is too high, overexcitation could occur and overheat the motor.

◆ n5: Feed Forward Control

Feed forward control increases the responsiveness of acceleration and deceleration as specified by the speed reference.

Increase the values set in *C5-01* and *C5-03* [ASR Proportional Gain] to apply feed forward control to machines that have low rigidity and are possible to have hunting and vibration or to machines that have a large quantity of inertia. When you use this function in CLV control, it also helps prevent overshoot. Refer to [Figure 12.147](#) for information. Refer to [Figure 12.148](#) for more information about parameters related to feed forward control.

Set *A1-02* [Control Method Selection] to one of these values to enable feed forward control:

- 3: Closed Loop Vector Control
- 4: Advanced OpenLoop Vector Control
- 6: PM Advanced Open Loop Vector
- 7: PM Closed Loop Vector Control

Note:

- You cannot use feed forward control to increase responsiveness in applications where you apply loads externally during run at constant speed.
- When you use the Droop control function, set *n5-01* = 0 [Feed Forward Control Selection = Disabled].
- You cannot use feed forward control with motor 2.

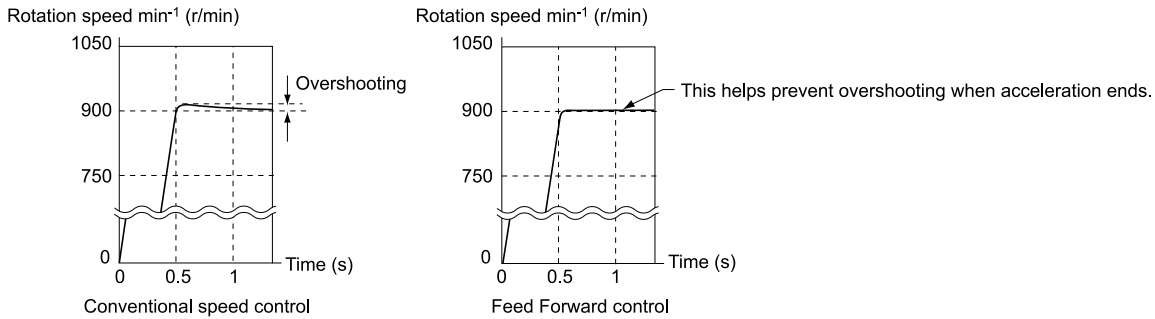

Figure 12.147 Suppress Overshooting with Feed Forward Control

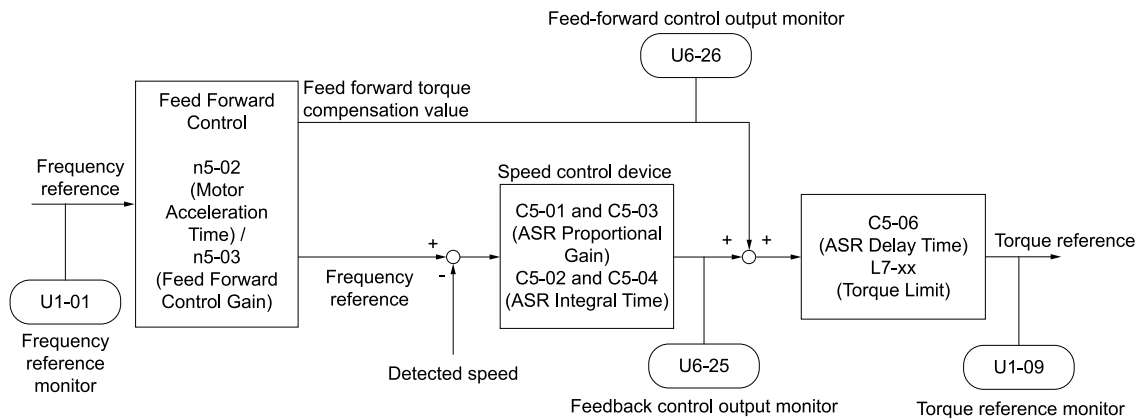

Figure 12.148 Configure Feed Forward Control

■ Before You Use Feed Forward Control

Do one of these procedures before you use feed forward control.

- Run Auto-Tuning to set motor parameters.
When you cannot do Auto-Tuning, manually set motor parameters with the information on the motor nameplate or test reports. Set the *E2* parameters for induction motors. Set the *E5* parameters for PM motors.
- Set *C5* parameters [Automatic Speed Regulator (ASR)] individually to adjust the speed control loop (ASR).
- If you can connect a motor to a machine and rotate it during Auto-Tuning, do Inertia Tuning. The drive automatically adjusts feed forward parameters during Inertia Tuning.
- If you cannot do Inertia Tuning, refer to [Figure 12.148](#) and set the parameters related to feed forward control individually.

■ n5-01: Feed Forward Control Selection

No. (Hex.)	Name	Description	Default (Range)
n5-01 (05B0)	Feed Forward Control Selection	<div style="display: flex; justify-content: space-between; align-items: center;"> V/f CL-V/f OLV CLV AOLV OLV/PM AOLV/PM CLV/PM EZOLV </div> Sets the feed forward function.	0 (0, 1)

0 : Disabled

1 : Enabled

■ n5-02: Motor Inertia Acceleration Time

No. (Hex.)	Name	Description	Default (Range)
n5-02 (05B1)	Motor Inertia Acceleration Time	<div style="display: flex; justify-content: space-between; align-items: center;"> V/f CL-V/f OLV CLV AOLV OLV/PM AOLV/PM CLV/PM EZOLV </div> Sets the length of time for the motor to accelerate from the stopped to the maximum frequency with a single motor at the rated torque. Inertia Tuning automatically sets the motor acceleration time.	Determined by C6-01, E5-01, and o2-04 (0.001 - 10.000 s)

If you cannot do Inertia Tuning, calculate the motor acceleration time as shown here or measure the motor acceleration time and set *n5-02* to this value.

Calculate the Motor Acceleration Time

Use this formula to find the motor acceleration time:

$$n5-02 = \frac{2\pi \cdot J_{\text{Motor}} \cdot n_{\text{rated}}}{60 \cdot T_{\text{rated}}}$$

- J_{Motor} = Moment of inertia of motor (kg m²)
- n_{rated} = Motor rated speed (min⁻¹, r/min)
- T_{rated} = Motor rated torque (N m)

You can also use this formula to find the motor acceleration time:

$$n5-02 = \frac{4\pi \cdot J_{\text{Motor}} \cdot f_{\text{rated}}}{p \cdot T_{\text{rated}}}$$

- f_{rated} = Motor rated frequency (Hz)
- p = Number of motor poles

Calculate the Motor Acceleration Time

Use this procedure to calculate the motor acceleration time:

1. Use *A1-02 [Control Method Selection]* to set the control method.
2. Disconnect the motor and load.
3. Run Auto-Tuning to set motor parameters.
When you cannot do Auto-Tuning, manually set motor parameters with the information on the motor nameplate or test reports. Set the *E2 parameters* for induction motors. Set the *E5 parameters* for PM motors.
4. Set *C5 parameters [Automatic Speed Regulator (ASR)]*.
5. Set *C1-01 [Acceleration Time 1] = 0*.
6. Set *L7-01 [Forward Torque Limit]* to 100%.
7. Set the frequency reference to the same value as the motor rated speed.
8. Measure the length of time for the motor to reach the rated speed.
Show *U1-05 [Motor Speed]* on the keypad and enter the Run command (forward run).
9. Stop the motor.
10. Set *n5-02* to the measured motor acceleration time value.

Reset all of the parameters that you changed to the previous setting values.

■ n5-03: Feed Forward Control Gain

No. (Hex.)	Name	Description	Default (Range)
n5-03 (05B2)	Feed Forward Control Gain	<div style="display: flex; justify-content: space-between; align-items: center;"> V/f CL-V/f OLV CLV AOLV OLV/PM AOLV/PM CLV/PM EZOLV </div> Sets the ratio between load inertia and motor inertia. Inertia Tuning automatically sets the Feedforward Control Gain value.	1.00 (0.00 - 100.00)

When you cannot do Inertia Tuning, use this procedure to set *n5-03*:

Set *n5-02 [Motor Inertia Acceleration Time]*.

1. Connect the motor and load.
2. Set *C1-01 [Acceleration Time 1] = 0*.
3. Use *L7-01 to L7-04 [Torque Limit]* to set the expected test run torque limit levels.
4. Set the frequency reference as specified by the high speed range of the machine.
5. Measure the length of time for the motor to reach the command reference speed. Show *U1-05 [Motor Speed]* on the keypad and enter the Run command.
6. Stop the motor.
7. Replace the values in the this formula and set *n5-03* to the value of the formula.

$$n5-03 = \frac{t_{\text{accel}} \cdot T_{\text{Lim_Test}} \cdot f_{\text{rated}}}{n5-02 \cdot f_{\text{ref_Test}} \cdot 100} - 1$$

- t_{accel} = Acceleration time (s)
- f_{rated} = Motor rated frequency (Hz)
- $T_{\text{Lim_Test}}$ = Test run torque limit (%)
- $f_{\text{ref_Test}}$ = Test run frequency reference (Hz)

WARNING! *Sudden Movement Hazard. Machinery can accelerate suddenly. Do not use this function with machinery that must not accelerate suddenly. Sudden starts can cause serious injury or death.*

Reset all of the parameters that you changed to the previous setting values.

Note:

- If response to the speed reference is slow, increase the value set in *n5-03*.
- Increase the value set in *n5-03* when response to the speed reference is slow.
 - The speed is overshooting.
 - A negative torque reference is output when acceleration ends.

■ **n5-04: Speed Response Frequency**

No. (Hex.)	Name	Description	Default (Range)
n5-04 (05B3) RUN Expert	Speed Response Frequency	<div style="display: flex; justify-content: space-between; font-size: small;"> V/f CL-V/f OLV CLV AOLV OLV/PM AOLV/PM CLV/PM EZOLV </div> <p>Sets the response frequency for the speed reference. Usually it is not necessary to change this parameter.</p>	Determined by A1-02 (0.00 - 500.00 Hz)

If you set *n5-03 [Feed Forward Control Gain]* too high, the motor speed will momentarily increase to more than the set frequency.

◆ **n6: Online Tuning**

n6 parameters are used to set the online tuning function for motor line-to-line resistance.

The Online Tuning for motor line-to-line resistance is used to prevent degradation of speed control accuracy due to motor temperature fluctuation and motor stalls due to insufficient torque.

■ **n6-01: Online Tuning Selection**

No. (Hex.)	Name	Description	Default (Range)
n6-01 (0570)	Online Tuning Selection	<div style="display: flex; justify-content: space-between; font-size: small;"> V/f CL-V/f OLV CLV AOLV OLV/PM AOLV/PM CLV/PM EZOLV </div> <p>Sets the type of motor data that Online Tuning uses for OLV control.</p>	0 (0 - 2)

0 : Disabled

1 : Line-to-Line Resistance Tuning

The drive adjusts the motor line-to-line resistance during run. This procedure is applicable for speed values 6 Hz and less. It also adjusts the motor resistance value to increase the overload capacity in the low speed range.

2 : Voltage Correction Tuning

The drive adjusts the output voltage during run to increase overload tolerance and minimize the effects of high temperatures on speed precision.

Note:

Setting 2 is enabled only when *b8-01 = 0 [Energy Saving Control Selection = Disabled]*.

■ n6-05: Online Tuning Gain

No. (Hex.)	Name	Description	Default (Range)
n6-05 (05C7) Expert	Online Tuning Gain	<div style="display: flex; justify-content: space-between; font-size: 0.8em;"> V/f CL-V/f OLV CLV AOLV OLV/PM AOLV/PM CLV/PM EZOLV </div> <p>Sets the compensation gain when $n6-01 = 2$ [Online Tuning Selection = Voltage Correction Tuning]. Usually it is not necessary to change this parameter.</p>	1.0 (0.1 - 50.0)

When you use a motor that has a large secondary circuit time constant, decrease the setting value.

If the drive detects *oL1* [Motor Overload], increase the setting value in 0.1-unit increments.

■ n6-11: Online Resistance Tuning

No. (Hex.)	Name	Description	Default (Range)
n6-11 (1B56) Expert	Online Resistance Tuning	<div style="display: flex; justify-content: space-between; font-size: 0.8em;"> V/f CL-V/f OLV CLV AOLV OLV/PM AOLV/PM CLV/PM EZOLV </div> <p>Sets the responsiveness for online resistor tuning. Set this parameter to approximately 1.000 to enable the function. The function is disabled when the value is 0.000.</p>	0.000 (0.000 - 1.000)

◆ n7: EZ Drive

The *n7* parameters provide special adjustments for EZ Vector Control.

■ n7-01: Damping Gain for Low Frequency

No. (Hex.)	Name	Description	Default (Range)
n7-01 (3111) Expert	Damping Gain for Low Frequency	<div style="display: flex; justify-content: space-between; font-size: 0.8em;"> V/f CL-V/f OLV CLV AOLV OLV/PM AOLV/PM CLV/PM EZOLV </div> <p>Sets the oscillation suppression gain for the low speed range.</p>	1.0 (0.1 - 10.0)

Note:

- If oscillation occurs in the low speed range, increase the acceleration time or increase the setting value in 0.5-unit increments.
- To get starting torque with the setting for *C4-01* [Torque Compensation Gain], decrease the setting value in 0.3-unit increments.

■ n7-05: Response Gain for Load Changes

No. (Hex.)	Name	Description	Default (Range)
n7-05 (3115) Expert	Response Gain for Load Changes	<div style="display: flex; justify-content: space-between; font-size: 0.8em;"> V/f CL-V/f OLV CLV AOLV OLV/PM AOLV/PM CLV/PM EZOLV </div> <p>Sets the response gain related to changes in the load.</p>	100 (10 - 1000)

Note:

To make tracking related to load changes better, increase the setting value in 5-unit increments. If oscillation occurs during load changes, decrease the setting value in 5-unit increments.

■ n7-07: Speed Calculation Gain1

No. (Hex.)	Name	Description	Default (Range)
n7-07 (3117) Expert	Speed Calculation Gain1	<div style="display: flex; justify-content: space-between; font-size: 0.8em;"> V/f CL-V/f OLV CLV AOLV OLV/PM AOLV/PM CLV/PM EZOLV </div> <p>Sets the speed calculation gain during usual operation. Usually it is not necessary to change this setting.</p>	15.0 (1.0 - 50.0)

■ n7-08: Speed Calculation Gain2

No. (Hex.)	Name	Description	Default (Range)
n7-08 (3118) Expert	Speed Calculation Gain2	<div style="display: flex; justify-content: space-between; font-size: 0.8em;"> V/f CL-V/f OLV CLV AOLV OLV/PM AOLV/PM CLV/PM EZOLV </div> <p>Sets the speed calculation gain during a speed search.</p>	25.0 (1.0 - 50.0)

Note:

When you increase the setting value, you can do a speed search of a motor rotating at a high frequency. If the setting value is too high, the calculated speed will oscillate and a restart will fail. Decrease the setting value in these conditions.

■ n7-10: Pull-in Current Switching Speed

No. (Hex.)	Name	Description	Default (Range)
n7-10 (311A) Expert	Pull-in Current Switching Speed	<div style="display: flex; justify-content: space-between; font-size: 0.8em;"> V/f CL-V/f OLV CLV AOLV OLV/PM AOLV/PM CLV/PM EZOLV </div> <p>Sets the speed range to operate with the pull-in current command. Drive rated frequency = 100% value. If there is a large quantity of oscillation when you operate in the low speed range, increase the setting value.</p>	10.0% (0.0 - 100.0%)

Note:

- When the drive accelerates, it enables these settings:
 - Motor speed $\leq n7-10 + n7-11$ [*Drv Mode Switch Hysteresis Band*]: *n8-51* [*Pull-in Current @ Acceleration*]
 - Motor speed $> n7-10 + n7-11$: *b8-01* [*Energy Saving Control Selection*]
- When the drive decelerates, it enables these settings:
 - Motor speed $\leq n7-10$: *n8-51* [*Pull-in Current @ Acceleration*]
 - Motor speed $> n7-10$: *b8-01* [*Energy Saving Control Selection*]
- If there is a large quantity of oscillation when you operate in the low speed range, increase the setting value.
- When it is most important to save energy in the low speed range, decrease the setting value.

■ n7-11: Drv Mode Switch Hysteresis Band

No. (Hex.)	Name	Description	Default (Range)
n7-11 (311B) Expert	Drv Mode Switch Hysteresis Band	<div style="display: flex; justify-content: space-between; font-size: 0.8em;"> V/f CL-V/f OLV CLV AOLV OLV/PM AOLV/PM CLV/PM EZOLV </div> <p>Usually it is not necessary to change this setting. Sets the hysteresis level for Switching Speed set in <i>n7-10</i> [<i>Pull-in Current Switching Speed</i>].</p>	5.0% (1.0 - 20.0%)

When the speed is lower than $n7-10 + n7-11$ during acceleration, the drive enables pull-in current.

Note:

- When the drive accelerates, it enables these settings:
 - Motor speed $\leq n7-10 + n7-11$: *n8-51* [*Pull-in Current @ Acceleration*]
 - Motor speed $> n7-10 + n7-11$: *b8-01* [*Energy Saving Control Selection*]
- If there is a large quantity of oscillation when you operate in the low speed range, increase the setting value.
- When it is most important to save energy in the low speed range, decrease the setting value.

■ n7-13: Pull-in Current Switching Time

No. (Hex.)	Name	Description	Default (Range)
n7-13 (311D) Expert	Driving Method Switching Time	<div style="display: flex; justify-content: space-between; font-size: 0.8em;"> V/f CL-V/f OLV CLV AOLV OLV/PM AOLV/PM CLV/PM EZOLV </div> <p>Sets a time to enable the pull-in current commands.</p>	100 ms (0 - 1000 ms)

If the motor oscillates near the speed set in *n7-10* [*Pull-in Current Switching Speed*], decrease the setting value by 20 ms.

■ n7-17: Resistance TemperatureCorrection

No. (Hex.)	Name	Description	Default (Range)
n7-17 (3122)	Resistance TemperatureCorrection	<div style="display: flex; justify-content: space-between; font-size: 0.8em;"> V/f CL-V/f OLV CLV AOLV OLV/PM AOLV/PM CLV/PM EZOLV </div> <p>Sets the function to adjust for changes in the motor resistance value caused by changes in the temperature.</p>	1 (0 to 2)

0 : Invalid

1 : Valid (Only 1 time)

2 : Valid (Every time)

Note:

- For settings 1 and 2, the adjustment time can cause a delay before startup.
- For settings 1 and 2, the drive can set the line-to-line resistance value of *E9-10* [*Motor Line-to-Line Resistance*].
- When the temperature will change at startup, use setting 2.
- To decrease the startup time, set this parameter to 0, then do line-to-line resistance tuning.
- If you will start from coasting, set this parameter to 0, then do line-to-line resistance tuning.

◆ n8: PM Motor Control Tuning

n8 parameters are used to make adjustments when controlling PM motors.

■ n8-01: Pole Position Detection Current

No. (Hex.)	Name	Description	Default (Range)
n8-01 (0540) Expert	Pole Position Detection Current	<input type="checkbox"/> V/f <input type="checkbox"/> CL-V/f <input type="checkbox"/> OLV <input type="checkbox"/> CLV <input type="checkbox"/> AOLV <input checked="" type="checkbox"/> OLV/PM <input checked="" type="checkbox"/> AOLV/PM <input checked="" type="checkbox"/> CLV/PM <input type="checkbox"/> EZOLV Sets the Initial Rotor Position Estimated Current as a percentage where <i>E5-03 [PM Motor Rated Current (FLA)]</i> = 100%. Usually it is not necessary to change this setting.	50% (0 - 100%)

The drive uses the Initial Rotor Position Estimated Current to detect the initial position of rotors.

Use the "Si" value on the motor nameplate, if available.

■ n8-02: Pole Alignment Current Level

No. (Hex.)	Name	Description	Default (Range)
n8-02 (0541) Expert	Pole Alignment Current Level	<input type="checkbox"/> V/f <input type="checkbox"/> CL-V/f <input type="checkbox"/> OLV <input type="checkbox"/> CLV <input type="checkbox"/> AOLV <input checked="" type="checkbox"/> OLV/PM <input checked="" type="checkbox"/> AOLV/PM <input checked="" type="checkbox"/> CLV/PM <input type="checkbox"/> EZOLV Sets the current at the time of polar attraction as a percentage where <i>E5-03 [PM Motor Rated Current (FLA)]</i> = 100%. Usually it is not necessary to change this setting.	80% (0 - 150%)

The drive uses the polar pull-in current to attract the rotor after it detects the initial rotor position. When you increase the value of *n8-02*, the starting torque also increases.

- If the motor does not track correctly at the time of the polar attraction, increase the value in 10% increments. If you set the value too high, the drive will detect *oL2 [Drive Overload]*.
- If the motor oscillates at the time of the polar attraction, decrease the value in 10% increments.

Note:

- When *A1-02 = 7 [Control Method Selection = CLV/PM]*, do Rotational Auto-Tuning or Z Pulse Offset Tuning to enable this function.

■ n8-03: Pole Position Detection Time

No. (Hex.)	Name	Description	Default (Range)
n8-03 (0542)	Pole Position Detection Time	<input type="checkbox"/> V/f <input type="checkbox"/> CL-V/f <input type="checkbox"/> OLV <input type="checkbox"/> CLV <input type="checkbox"/> AOLV <input checked="" type="checkbox"/> OLV/PM <input checked="" type="checkbox"/> AOLV/PM <input checked="" type="checkbox"/> CLV/PM <input type="checkbox"/> EZOLV Sets the length of the Current Starting Time, which is used for Z Pulse Offset Tuning. Usually it is not necessary to change this setting.	1.5 s (1.5 - 5.0 s)

Sets the length of time of pull-in current when the drive detects the motor magnetic pole of the rotors.

Note:

If the motor oscillates at the time of the polar attraction, increase the value in 0.5 s increments. If the value is too high, the drive can detect *oL2 [Drive Overload]*.

■ n8-04: Pole Alignment Time

No. (Hex.)	Name	Description	Default (Range)
n8-04 (0543) Expert	Pole Alignment Time	<input type="checkbox"/> V/f <input type="checkbox"/> CL-V/f <input type="checkbox"/> OLV <input type="checkbox"/> CLV <input type="checkbox"/> AOLV <input checked="" type="checkbox"/> OLV/PM <input checked="" type="checkbox"/> AOLV/PM <input checked="" type="checkbox"/> CLV/PM <input type="checkbox"/> EZOLV Sets the length of the Polar Attraction Time, which is used for Z Pulse Offset Tuning. Usually it is not necessary to change this setting.	1.5 s (1.5 - 5.0 s)

Sets the length of time that the pull-in current flows when the drive detects the motor magnetic pole of the rotors.

Note:

If the motor oscillates at the time of the polar attraction, increase the value in 0.5 s increments. If you set the value too high, the drive will detect *oL2 [Drive Overload]*.

■ n8-11: Observer Calculation Gain 2

No. (Hex.)	Name	Description	Default (Range)
n8-11 (054A)	Observer Calculation Gain ²	<input type="checkbox"/> V/f <input type="checkbox"/> CL-V/f <input type="checkbox"/> OLV <input type="checkbox"/> CLV <input type="checkbox"/> AOLV <input checked="" type="checkbox"/> OLV/PM <input checked="" type="checkbox"/> AOLV/PM <input checked="" type="checkbox"/> CLV/PM <input type="checkbox"/> EZOLV Sets the gain for speed estimation. Usually it is not necessary to change this setting.	Determined by n8-72 (0.0 - 1000.0)

Note:

When *n8-72 = 0 [Speed Estimation Method Select = Method 1]*, the default value is 50.0. When *n8-72 = 1 [Method 2]*, the default value is 150.0.

■ **n8-14: Polarity Compensation Gain 3**

No. (Hex.)	Name	Description	Default (Range)
n8-14 (054D) Expert	Polarity Compensation Gain 3	<div style="display: flex; justify-content: space-between; font-size: 0.8em;"> V/f CL-V/f OLV CLV AOLV OLV/PM AOLV/PM CLV/PM EZOLV </div> <p>Sets the gain for speed estimation. Usually it is not necessary to change this setting.</p>	1.000 (0.000 - 10.000)

■ **n8-15: Polarity Compensation Gain 4**

No. (Hex.)	Name	Description	Default (Range)
n8-15 (054E) Expert	Polarity Compensation Gain 4	<div style="display: flex; justify-content: space-between; font-size: 0.8em;"> V/f CL-V/f OLV CLV AOLV OLV/PM AOLV/PM CLV/PM EZOLV </div> <p>Sets the gain for speed estimation. Usually it is not necessary to change this setting.</p>	0.500 (0.000 - 10.000)

■ **n8-21: Motor Back-EMF (Ke) Gain**

No. (Hex.)	Name	Description	Default (Range)
n8-21 (0554) Expert	Motor Back-EMF (Ke) Gain	<div style="display: flex; justify-content: space-between; font-size: 0.8em;"> V/f CL-V/f OLV CLV AOLV OLV/PM AOLV/PM CLV/PM EZOLV </div> <p>Sets the gain for speed estimation. Usually it is not necessary to change this setting.</p>	0.90 (0.80 - 1.00)

■ **n8-35: Initial Pole Detection Method**

No. (Hex.)	Name	Description	Default (Range)
n8-35 (0562)	Initial Pole Detection Method	<div style="display: flex; justify-content: space-between; font-size: 0.8em;"> V/f CL-V/f OLV CLV AOLV OLV/PM AOLV/PM CLV/PM EZOLV </div> <p>Sets how the drive detects the position of the rotor at start.</p>	Determined by A1-02 (0 - 2)

When you set $A1-02 = 7$ [*Control Method Selection = CLV/PM*], the initial motor magnetic pole detection operates the first time after you energize the drive. After the first time, the drive uses the encoder signal to calculate the rotor position and the drive saves the value until you de-energize the drive. If you use an absolute value encoder, the initial motor magnetic pole detection will not operate.

Note:

- When you use an SPM motor, set $n8-35 = 0$. When you use an IPM motor, set $n8-35 = 0$ to 2.
- When you set $n8-35 = 1$, do High Frequency Injection Auto-Tuning.
- When you set $n8-35 = 0$ or 2, always evaluate the drive with the equipment being used for the application. If the drive incorrectly detects the polarity, the motor can rotate in the direction opposite of the Run command.

0 : Pull-in

Starts the rotor with pull-in current.

1 : High Frequency Injection

Injects high frequency to detect the rotor position. This setting can cause a loud excitation sound when the motor starts.

Note:

When you set 1, do High Frequency Injection Auto-Tuning.

2 : Pulse Injection

Inputs the pulse signal to the motor to detect the rotor position.

■ **n8-36: HFI Frequency Level for L Tuning**

No. (Hex.)	Name	Description	Default (Range)
n8-36 (0563)	HFI Frequency Level for L Tuning	<div style="display: flex; justify-content: space-between; font-size: 0.8em;"> V/f CL-V/f OLV CLV AOLV OLV/PM AOLV/PM CLV/PM EZOLV </div> <p>Sets the injection frequency for high frequency injection.</p>	500 Hz (200 - 1000 Hz)

Note:

- Set $n8-35 = 1$ [*Initial Pole Detection Method = High Frequency Injection*] or $n8-57 = 1$ [*HFI Overlap Selection = Enabled*] to enable this parameter.
- The drive automatically calculates this value when High Frequency Injection Auto-Tuning completes successfully.

■ n8-37: HFI Voltage Amplitude Level

No. (Hex.)	Name	Description	Default (Range)
n8-37 (0564) Expert	HFI Voltage Amplitude Level	<div style="display: flex; justify-content: space-between; font-size: 0.8em;"> V/f CL-V/f OLV CLV AOLV OLV/PM AOLV/PM CLV/PM EZOLV </div> <p>Sets the high frequency injection amplitude as a percentage where 200 V = 100% for 200 V class drives and 400 V = 100% for a 400 V class drives. Usually it is not necessary to change this setting.</p>	20.0% (0.0 - 50.0%)

Note:

- Set $n8-35 = 1$ [Initial Pole Detection Method = High Frequency Injection] or $n8-57 = 1$ [HFI Overlap Selection = Enabled] to enable this parameter.
- The drive automatically calculates this value when High Frequency Injection Auto-Tuning completes successfully.

■ n8-39: HFI LPF Cutoff Freq

No. (Hex.)	Name	Description	Default (Range)
n8-39 (0566)	HFI LPF Cutoff Freq	<div style="display: flex; justify-content: space-between; font-size: 0.8em;"> V/f CL-V/f OLV CLV AOLV OLV/PM AOLV/PM CLV/PM EZOLV </div> <p>Sets the low-pass filter shut-off frequency for high frequency injection.</p>	250 Hz (0 - 1000 Hz)

Note:

- Set $n8-35 = 1$ [Initial Pole Detection Method = High Frequency Injection] or $n8-57 = 1$ [HFI Overlap Selection = Enabled] to enable this parameter.
- The drive automatically calculates this value when High Frequency Injection Auto-Tuning completes successfully.

■ n8-41: HFI P Gain

No. (Hex.)	Name	Description	Default (Range)
n8-41 (0568) Expert	HFI P Gain	<div style="display: flex; justify-content: space-between; font-size: 0.8em;"> V/f CL-V/f OLV CLV AOLV OLV/PM AOLV/PM CLV/PM EZOLV </div> <p>Sets the response gain for the high frequency injection speed estimation.</p>	2.5 (-10.0 - +10.0)

Note:

- Set $n8-35 = 1$ [Initial Pole Detection Method = High Frequency Injection] or $n8-57 = 1$ [HFI Overlap Selection = Enabled] to enable this parameter.
- When $A1-02 = 6$ [Control Method Selection = AOLV/PM] and you do High Frequency Injection Auto-Tuning, the drive automatically sets this parameter.
- Set $n8-41 > 0.0$ for IPM motors.

Set this parameter as follows.

- If there is oscillation or hunting, decrease the setting in units of 0.5.
- When it is necessary to track load changes, increase the setting in units of 0.5.

■ n8-42: HFI I Time

No. (Hex.)	Name	Description	Default (Range)
n8-42 (0569) Expert	HFI I Time	<div style="display: flex; justify-content: space-between; font-size: 0.8em;"> V/f CL-V/f OLV CLV AOLV OLV/PM AOLV/PM CLV/PM EZOLV </div> <p>Sets the integral time constant for the high frequency injection speed estimation. Usually it is not necessary to change this setting.</p>	0.10 s (0.00 - 9.99 s)

Note:

Set $n8-35 = 1$ [Initial Pole Detection Method = High Frequency Injection] or $n8-57 = 1$ [HFI Overlap Selection = Enabled] to enable this parameter.

■ n8-45: Speed Feedback Detection Gain

No. (Hex.)	Name	Description	Default (Range)
n8-45 (0538)	Speed Feedback Detection Gain	<div style="display: flex; justify-content: space-between; font-size: 0.8em;"> V/f CL-V/f OLV CLV AOLV OLV/PM AOLV/PM CLV/PM EZOLV </div> <p>Sets the internal speed feedback detection reduction unit gain as a magnification value. Usually it is not necessary to change this setting.</p>	0.80 (0.00 - 10.00)

Adjust this parameter in these conditions:

- If vibration or hunting occur, increase the setting value in 0.05 unit increments.
- If the responsiveness of torque and speed is unsatisfactory, decrease the setting value 0.05 unit increments and examine the response.

■ **n8-47: Pull-in Current Comp Filter Time**

No. (Hex.)	Name	Description	Default (Range)
n8-47 (053A)	Pull-in Current Comp Filter Time	<div style="display: flex; justify-content: space-between; font-size: small;"> V/f CL-V/f OLV CLV AOLV OLV/PM AOLV/PM CLV/PM EZOLV </div> <p>Sets the time constant the drive uses to align the pull-in current reference value with the actual current value. Usually it is not necessary to change this setting.</p>	5.0 s (0.0 - 100.0 s)

Adjust this parameter in these conditions:

- If the time for the reference value of the pull-in current to align with the target value is too long, increase the setting value.
- If vibration or hunting occur, decrease the setting value in 0.2 unit increments.
- If the motor stalls during run at constant speed, decrease the setting value in 0.2 unit increments.

■ **n8-48: Pull-in/Light Load Id Current**

No. (Hex.)	Name	Description	Default (Range)
n8-48 (053B)	Pull-in/Light Load Id Current	<div style="display: flex; justify-content: space-between; font-size: small;"> V/f CL-V/f OLV CLV AOLV OLV/PM AOLV/PM CLV/PM EZOLV </div> <p>Sets the d-axis current that flows to the motor during run at constant speed as a percentage where <i>E5-03 [PM Motor Rated Current (FLA)]</i> = 100%.</p>	30% (20 - 200%)

Adjust in the following situations.

- Slightly reduce this value if there is too much current when driving a light load at a constant speed.
- Increase the setting value in steps of 5% when hunting or vibration occurs during run at constant speed.
- Increase the setting value in steps of 5% if the motor stalls during run at constant speed.

■ **n8-49: Heavy Load Id Current**

No. (Hex.)	Name	Description	Default (Range)
n8-49 (053C) Expert	Heavy Load Id Current	<div style="display: flex; justify-content: space-between; font-size: small;"> V/f CL-V/f OLV CLV AOLV OLV/PM AOLV/PM CLV/PM EZOLV </div> <p>Sets the d-axis current to that the drive will supply to the motor to run it at a constant speed with a heavy load. Considers <i>E5-03 [PM Motor Rated Current (FLA)]</i> to be 100%. Usually it is not necessary to change this setting.</p>	Determined by E5-01 (-200.0 - 0.0%)

When you use an IPM motor, you can use the reluctance torque of the motor to make the motor more efficient and help conserve energy.

When you operate an SPN motor, set this parameter to 0.

Adjust this parameter in these conditions:

- If the load is large and motor rotation is not stable, decrease the setting value.
- If you change the *E5 parameters [PM Motor Settings]*, set *n8-49 = 0*, then adjust this parameter.

■ **n8-51: Pull-in Current @ Acceleration**

No. (Hex.)	Name	Description	Default (Range)
n8-51 (053E)	Pull-in Current @ Acceleration	<div style="display: flex; justify-content: space-between; font-size: small;"> V/f CL-V/f OLV CLV AOLV OLV/PM AOLV/PM CLV/PM EZOLV </div> <p>Sets the pull-in current allowed to flow during acceleration/deceleration as a percentage of the motor rated current.</p>	Determined by A1-02 (0 - 200%)

Adjust in the following situations.

- When the motor does not smoothly because of large loads, increase the setting value in 5% increments.
- If too much current flows during acceleration, decrease the setting value.

Note:

When *A1-02 = 8 [Control Method Selection = EZOLV]*, this parameter will always be in effect for speed ranges less than *n7-10 [Pull-in Current Switching Speed]*.

■ **n8-54: Voltage Error Compensation Time**

No. (Hex.)	Name	Description	Default (Range)
n8-54 (056D) Expert	Voltage Error Compensation Time	<div style="display: flex; justify-content: space-between; font-size: small;"> V/f CL-V/f OLV CLV AOLV OLV/PM AOLV/PM CLV/PM EZOLV </div> <p>Sets the time constant that the drive uses when adjusting for voltage errors.</p>	1.00 s (0.00 - 10.00 s)

Adjust this parameter in these conditions:

- If oscillation occurs at the time of start up, increase the setting value.
- If hunting occurs when operating at low speed, increase the setting value.
- If fast changes in the load cause hunting, increase the setting value in 0.1-unit increments. If you cannot stop hunting, set *n8-51 [Pull-in Current @ Acceleration]* to 0% and set *n8-54* to 0.00 s, and disable compensation for voltage errors.

■ n8-55: Motor to Load Inertia Ratio

No. (Hex.)	Name	Description	Default (Range)
n8-55 (056E)	Motor to Load Inertia Ratio	V/f CL-V/f OLV CLV AOLV OLV/PM AOLV/PM CLV/PM EZOLV Sets the ratio between motor inertia and machine inertia.	0 (0 - 3)

Sets the ratio between motor inertia and machine inertia to adjust the ACR.

Adjust in the following situations.

- If torque and speed response are unsatisfactory, gradually increase the setting from 0.
- If the motor does not run smoothly, gradually increase the setting from 0.
- If the motor stalls during run at constant speed, gradually increase the setting from 0.
- If there is vibration or hunting, decrease the setting.

Note:

- If the value too low, the drive will detect *STPo [Motor Step-Out Detected]*.
- If you use one motor or more than motor at low inertia and the value is too high, there can be vibration in the motor.

0 : Below 1:10

Use this setting in these conditions:

- The ratio between the motor inertia and machine inertia is less than 1:10
- There are large current ripples

1 : Between 1:10 and 1:30

Use this setting in these conditions:

- The ratio between the motor inertia and machine inertia is approximately 1:10 to 1:30
- Parameter *n8-55 = 0* and the drive detects *STPo* because of an impact load or sudden acceleration/deceleration.

2 : Between 1:30 and 1:50

Use this setting in these conditions:

- The ratio between the motor inertia and machine inertia is approximately 1:30 to 1:50
- Parameter *n8-55 = 1* and the drive detects *STPo* because of an impact load or sudden acceleration/deceleration.

3 : Beyond 1:50

Adjust this parameter in these conditions:

- The ratio between the motor inertia and machine inertia is more than 1:50
- Parameter *n8-55 = 2* and the drive detects *STPo* because of an impact load or sudden acceleration/deceleration.

■ n8-57: HFI Overlap Selection

No. (Hex.)	Name	Description	Default (Range)
n8-57 (0574)	HFI Overlap Selection	V/f CL-V/f OLV CLV AOLV OLV/PM AOLV/PM CLV/PM EZOLV Sets the function that detects motor speed with high frequency injection.	0 (0, 1)

Note:

- When you set *n8-57 = 1*, do High Frequency Injection Auto-Tuning.
- When there is high frequency injection, the motor will make an excitation sound.
- When you use Zero Speed Control, set *E1-09 = 0.0 [Minimum Output Frequency = 0.0 Hz]*.

0 : Disabled

Use this setting with SPM motors. The speed control range is approximately 1:20.

When *n8-57 = 0*, you cannot set *E1-09 [Minimum Output Frequency]* $\leq 1/20$ of the value of *E1-06 [Base Frequency]*.

1 : Enabled

The speed control range is 1:100. It gives sufficient speed detection at low speeds.

Note:

- It is not available with an SPM motor.
- The speed control range 1:100 is the momentary operation area. When you operate the motor continuously, make sure that the drive capacity and motor capacity are acceptable.

■ **n8-62: Output Voltage Limit Level**

No. (Hex.)	Name	Description	Default (Range)
n8-62 (057D) Expert	Output Voltage Limit Level	<div style="display: flex; justify-content: space-between; font-size: small;"> V/f CL-V/f OLV CLV AOLV OLV/PM AOLV/PM CLV/PM EZOLV </div> <p>Sets the output voltage limit to prevent saturation of the output voltage. Usually it is not necessary to change this parameter.</p>	200 V Class: 200.0 V, 400 V Class: 400.0 V (200 V Class: 0.0 to 230.0 V, 400 V Class: 0.0 to 460.0 V)

Set this parameter lower than the input power supply voltage.

Note:

- When A1-02 = 7, 8 [Control Method Selection = CLV/PM, EZOLV], this parameter is available in Expert mode.

■ **n8-65: Speed Fdbk Gain @ oV Suppression**

No. (Hex.)	Name	Description	Default (Range)
n8-65 (065C) Expert	Speed Fdbk Gain @ oV Suppression	<div style="display: flex; justify-content: space-between; font-size: small;"> V/f CL-V/f OLV CLV AOLV OLV/PM AOLV/PM CLV/PM EZOLV </div> <p>Sets the gain of internal speed feedback detection suppression while the overvoltage suppression function is operating as a magnification value. Usually it is not necessary to change this parameter.</p>	1.50 (0.00 - 10.00)

Adjust this parameter in these conditions:

- If there is resonance or hunting when you use the overvoltage suppression function, increase the setting value.
- If motor response is low when you use the overvoltage suppression function, decrease the setting value in 0.05-unit increments.

■ **n8-69: Speed Observer Control P Gain**

No. (Hex.)	Name	Description	Default (Range)
n8-69 (065D) Expert	Speed Observer Control P Gain	<div style="display: flex; justify-content: space-between; font-size: small;"> V/f CL-V/f OLV CLV AOLV OLV/PM AOLV/PM CLV/PM EZOLV </div> <p>Usually it is not necessary to change this setting. Sets the Proportional gain that the drive uses for speed estimation.</p>	1.00 (0.00 - 20.00)

■ **n8-72: Speed Estimation Method Select**

No. (Hex.)	Name	Description	Default (Range)
n8-72 (0655) Expert	Speed Estimation Method Select	<div style="display: flex; justify-content: space-between; font-size: small;"> V/f CL-V/f OLV CLV AOLV OLV/PM AOLV/PM CLV/PM EZOLV </div> <p>Selects the speed estimation method. Usually it is not necessary to change this setting.</p>	1 (0, 1)

0 : Method 1

1 : Method 2

■ **n8-74: Light Load Iq Level**

No. (Hex.)	Name	Description	Default (Range)
n8-74 (05C3) Expert	Light Load Iq Level	<div style="display: flex; justify-content: space-between; font-size: small;"> V/f CL-V/f OLV CLV AOLV OLV/PM AOLV/PM CLV/PM EZOLV </div> <p>Set n8-48 [Pull-in/Light Load Id Current] to the percentage of load current (q-axis current) that you will apply, where E5-03 [PM Motor Rated Current (FLA)] = a setting value of 100%.</p>	30% (0 - 255%)

Note:

- If n8-74 > n8-75 [Medium Load Iq Level (low)], the drive will detect oPE08 [Parameter Selection Error].
- The change is linear between n8-74 and n8-75 and the level of the pull-in current from n8-48 to n8-78 [Medium Load Id Current].

■ n8-75: Medium Load Iq Level (low)

No. (Hex.)	Name	Description	Default (Range)
n8-75 (05C4) Expert	Medium Load Iq Level (low)	<div style="display: flex; justify-content: space-between; font-size: 0.8em;"> V/f CL-V/f OLV CLV AOLV OLV/PM AOLV/PM CLV/PM EZOLV </div> <p>Set n8-78 [Medium Load Id Current] to the percentage of load current (q-axis current) that you will apply, where E5-03 [PM Motor Rated Current (FLA)] = a setting value of 100%.</p>	50% (0 - 255%)

Note:

- If n8-74 [Light Load Iq Level] > n8-75, the drive will detect oPE08 [Parameter Selection Error].
- The change is linear between n8-74 and n8-75 and the level of the pull-in current from n8-48 to n8-78 [Medium Load Id Current].

■ n8-77: Heavy Load Iq Level

No. (Hex.)	Name	Description	Default (Range)
n8-77 (05CE) Expert	Heavy Load Iq Level	<div style="display: flex; justify-content: space-between; font-size: 0.8em;"> V/f CL-V/f OLV CLV AOLV OLV/PM AOLV/PM CLV/PM EZOLV </div> <p>Set n8-49 [Heavy Load Id Current] to the percentage of load current (q-axis current) that you will apply, where E5-03 [PM Motor Rated Current (FLA)] = a setting value of 100%.</p>	90% (0 - 255%)

Note:

The change is linear between n8-75 [Medium Load Iq Level (low)] and n8-77 and the level of the pull-in current from n8-78 [Medium Load Id Current] to n8-49 [Heavy Load Id Current].

■ n8-78: Medium Load Id Current

No. (Hex.)	Name	Description	Default (Range)
n8-78 (05F4) Expert	Medium Load Id Current	<div style="display: flex; justify-content: space-between; font-size: 0.8em;"> V/f CL-V/f OLV CLV AOLV OLV/PM AOLV/PM CLV/PM EZOLV </div> <p>Sets the level of the pull-in current for mid-range loads.</p>	0% (0 - 255%)

■ n8-79: Pull-in Current @ Deceleration

No. (Hex.)	Name	Description	Default (Range)
n8-79 (05FE)	Pull-in Current @ Deceleration	<div style="display: flex; justify-content: space-between; font-size: 0.8em;"> V/f CL-V/f OLV CLV AOLV OLV/PM AOLV/PM CLV/PM EZOLV </div> <p>Sets the pull-in current that can flow during deceleration as a percentage of the E5-03 [PM Motor Rated Current (FLA)].</p>	50% (0 - 200%)

If overcurrent occurs during deceleration, slowly decrease the setting in 5% increments.

Note:

When n8-79 = 0, the drive will use the value set in n8-51 [Pull-in Current @ Acceleration].

■ n8-84: Polarity Detection Current

No. (Hex.)	Name	Description	Default (Range)
n8-84 (02D3) Expert	Polarity Detection Current	<div style="display: flex; justify-content: space-between; font-size: 0.8em;"> V/f CL-V/f OLV CLV AOLV OLV/PM AOLV/PM CLV/PM EZOLV </div> <p>Sets the current that the drive uses to estimate the initial motor magnetic pole as a percentage where E5-03 [PM Motor Rated Current (FLA)] = 100%.</p>	100% (0 - 150%)

Note:

The drive automatically calculates this value when High Frequency Injection Auto-Tuning completes successfully.

WARNING! Sudden Movement Hazard. Make sure that the polarity is correct before you send a Run command. If the drive incorrectly detects the polarity, the drive can rotate in the direction opposite of the Run command and cause serious injury or death.

When you use a Yaskawa motor, check the motor nameplate for an "Si" value and set this parameter \geq "Si \times 2". Consult the motor manufacturer for information about maximum setting values.

Find the Polarity of Magnetic Poles

When you start operation, the drive estimates the magnetic poles and finds the polarity of the magnetic poles. When A1-02 = 7 [Control Method Selection = CLV/PM], the drive finds the polarity of the magnetic poles only at the first startup.

Use U6-57 [PolePolarityDeterVal] to make sure that the drive correctly estimated the polarity of the magnetic poles.

When you do High Frequency Injection Auto-Tuning, the drive automatically sets n8-84.

Note:

If the drive detects *dv3*, *dv4*, or *LSO*, increase the setting value.

■ n8-94: Flux Position Estimation Method

No. (Hex.)	Name	Description	Default (Range)
n8-94 (012D) Expert	Flux Position Estimation Method	<div style="display: flex; justify-content: space-between; font-size: small;"> V/f CL-V/f OLV CLV AOLV OLV/PM AOLV/PM CLV/PM EZOLV </div> <p>Sets the criteria that the drive uses to find changes in speed or load. Usually it is not necessary to change this setting.</p>	Determined by d5-01 (0, 1)

0 : Softstarter

1 : Speed Feedback

Set $n8-57 = 1$ [*HFI Overlap Selection = Enabled*] to enable this parameter. Increases the stability when the speed or load suddenly change, for example with rapid acceleration/deceleration or impact loads.

■ n8-95: Flux Position Est Filter Time

No. (Hex.)	Name	Description	Default (Range)
n8-95 (012E) Expert	Flux Position Est Filter Time	<div style="display: flex; justify-content: space-between; font-size: small;"> V/f CL-V/f OLV CLV AOLV OLV/PM AOLV/PM CLV/PM EZOLV </div> <p>Sets the time constant of the filter used for the recognition criteria value for speed and load changes. Usually it is not necessary to change this setting.</p>	30 ms (0 - 100 ms)

Note:

Enabled when $n8-94 = 1$ [*Flux Position Estimation Method = Speed Feedback*].

12.11 o: Keypad-Related Settings

o parameters set keypad functions.

Note:

You cannot set these parameters with the optional LED keypad.

Table 12.79 Parameters You Cannot Set with the LED Keypad

No.	Name	No.	Name
o1-05	LCD Contrast Adjustment	o3-04	Select Backup/Restore Location
o1-24 to o1-35:	Custom Monitor 1 to 12	o3-05	Select Items to Backup/Restore
o1-36	LCD Backlight Brightness	o3-06	Auto Parameter Backup Selection
o1-37	LCD Backlight ON/OFF Selection	o3-07	Auto Parameter Backup Interval
o1-38	LCD Backlight Off-Delay	o4-22	Time Format
o1-39	Show Initial Setup Screen	o4-23	Date Format
o1-40	Home Screen Display Selection	o4-24	bAT Detection Selection
o1-41 to o1-46:	1st to 3rd Monitor Area Selections/Settings	o5-01	Log Start/Stop Selection
o1-47 to o1-51:	Trend Plot 1 or 2 Scale Settings	o5-02	Log Sampling Interval
o1-55 to o1-56:	Analog Gauge Area Selection/Setting	o5-03 to o5-12:	Log Monitor Data 1 to 10
o2-27	bCE Detection Selection		

◆ o1: Keypad Display Selection

o1 parameters select the parameters shown on the initial keypad screen and to configure the parameter setting units and display units. These parameters also adjust the backlight and contrast of the LCD display.

■ Home Screen Display Format

o1-40 [Home Screen Display Selection] changes the display of the monitor shown on the Home screen. You can show numerical values or one of these three displays on the Home screen monitor:

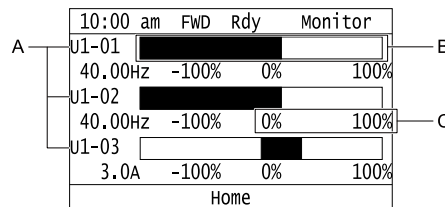

- A** - Set *Ux-xx* [Monitors] to *o1-24*, *o1-25*, and *o1-26*. **C** - Set display ranges to *o1-42*, *o1-44*, and *o1-46*.
B - Set display regions to *o1-41*, *o1-43*, and *o1-45*.

Figure 12.149 Bar Graph Display

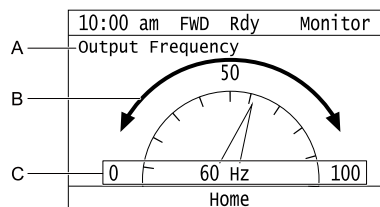

- A** - Set *Ux-xx* [Monitors] to *o1-24*. **C** - Set display ranges to *o1-55*.
B - Set display regions to *o1-56*.

Figure 12.150 Analog Gauge Display

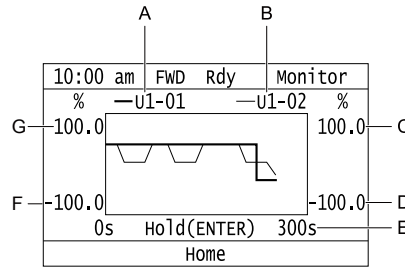

- A - Set $Ux-xx$ [Monitors] (Monitor 1) to o1-24.
- B - Set $Ux-xx$ [Monitors] (Monitor 2) to o1-25.
- C - Set the maximum value of Monitor 2 to o1-50.
- D - Set the minimum value of Monitor 2 to o1-49.
- E - Set the time scale to o1-51.
- F - Set the minimum value of Monitor 1 to o1-47.
- G - Set the maximum value of Monitor 1 to o1-48.

Figure 12.151 Trend Plot Display

o1-01: User Monitor Selection

No. (Hex.)	Name	Description	Default (Range)
o1-01 (0500) RUN	User Monitor Selection	V/f CL-V/f OLV CLV AOLV OLV/PM AOLV/PM CLV/PM EZOLV Sets the <i>U</i> monitor for the Drive Mode. This parameter is only available with an LED keypad.	106 (104 - 855)

When the drive is in Drive Mode, push on the keypad to cycle through this data: frequency reference → rotational direction → output frequency → output current → o1-01 selection.

Set the $x-xx$ part of $Ux-xx$ that is shown in the fifth position in Drive Mode. For example, to show $U1-05$ [Motor Speed], set $o1-01 = 105$.

Note:

The monitors that you can select are different for different control methods.

o1-02: Monitor Selection at Power-up

No. (Hex.)	Name	Description	Default (Range)
o1-02 (0501) RUN	Monitor Selection at Power-up	V/f CL-V/f OLV CLV AOLV OLV/PM AOLV/PM CLV/PM EZOLV Sets the monitor item that the keypad screen shows after you energize the drive. Refer to "U: Monitors" for information about the monitor items that the keypad screen can show. This parameter is only available with an LED keypad.	1 (1 - 5)

1 : Frequency Reference (U1-01)

2 : Direction

3 : Output Frequency (U1-02)

4 : Output Current (U1-03)

5 : User Monitor (o1-01)

Shows the monitor item selected in o1-01 [User Monitor Selection].

o1-03: Frequency Display Unit Selection

No. (Hex.)	Name	Description	Default (Range)
o1-03 (0502)	Frequency Display Unit Selection	V/f CL-V/f OLV CLV AOLV OLV/PM AOLV/PM CLV/PM EZOLV Sets the display units for the frequency reference and output frequency.	Determined by A1-02 (0 - 3)

Note:

- Select the setting unit of these parameters:
 - d1-01 to d1-17 [Reference 1 to 16, Jog Reference]
 - U1-01 [Frequency Reference]
 - U1-02 [Output Frequency]
 - U1-05 [Motor Speed]
 - U1-16 [SFS Output Frequency]
 - U4-14 [PeakHold Output Freq]
 - U6-27 [FeedFwd Estimate Spd]
- For monitor 2, the setting value is always 0 [Hz Unit].

0 : 0.01 Hz**1 : 0.01% (100% = E1-04)**

The maximum output frequency is 100%.

2 : min⁻¹ (r/min) units

The drive uses the maximum output frequency and number of motor poles to calculate this value automatically.

Note:

When you set *o1-03* = 2, make sure that you set the number of motor poles in these parameters:

- *E2-04* [Motor Pole Count]
- *E4-04* [Motor 2 Motor Poles]
- *E5-04* [PM Motor Pole Count]
- *E9-08* [Motor Pole Count]

3 : User Units (o1-10 & o1-11)

Uses *o1-10* [User Units Maximum Value] and *o1-11* [User Units Decimal Position] to set the unit of measure. The value of parameter *o1-10* is the value when you remove the decimal point from the maximum output frequency. Parameter *o1-11* is to the number of digits after the decimal point in the maximum output frequency.

To display a maximum output frequency of 100.00, set parameters to these values:

- *o1-10* = 10000
- *o1-11* = 2 [Two Decimal Places (XXX.XX)]

■ o1-04: V/f Pattern Display Unit

No. (Hex.)	Name	Description	Default (Range)
o1-04 (0503)	V/f Pattern Display Unit	<div style="display: flex; justify-content: space-between; align-items: center;"> V/f CL-V/f OLV CLV AOLV OLV/PM AOLV/PM CLV/PM EZOLV </div> Sets the setting unit for parameters that set the V/f pattern frequency.	Determined by A1-02 (0, 1)

Note:

- Select the setting unit of these parameters:
 - *E1-04* [Maximum Output Frequency]
 - *E1-06* [Base Frequency]
 - *E1-07* [Mid Point A Frequency]
 - *E1-09* [Minimum Output Frequency]
 - *E1-11* [Mid Point B Frequency]
 - *E9-02* [Maximum Speed]
 - *E9-04* [Base Frequency]
- For monitor 2, the setting value is always 0 [Hz Unit].

0 : Hz**1 : min⁻¹ (r/min) units**

When you set *o1-04* = 1, make sure that you set the number of motor poles in these parameters:

- *E2-04* [Motor Pole Count]
- *E5-04* [PM Motor Pole Count]
- *E9-08* [Motor Pole Count]

■ o1-05: LCD Contrast Adjustment

No. (Hex.)	Name	Description	Default (Range)
o1-05 (0504) RUN	LCD Contrast Adjustment	<div style="display: flex; justify-content: space-between; align-items: center;"> V/f CL-V/f OLV CLV AOLV OLV/PM AOLV/PM CLV/PM EZOLV </div> Sets the contrast of the LCD display on the keypad.	5 (0 - 10)

When you decrease the setting value, the contrast of the LCD display decreases. When you increase the setting value, the contrast increases.

■ o1-10: User Units Maximum Value

No. (Hex.)	Name	Description	Default (Range)
o1-10 (0520)	User Units Maximum Value	<div style="display: flex; justify-content: space-between; align-items: center;"> V/f CL-V/f OLV CLV AOLV OLV/PM AOLV/PM CLV/PM EZOLV </div> Sets the value that the drive shows as the maximum output frequency.	Determined by o1-03 (1 - 60000)

12.11 o: Keypad-Related Settings

To display a maximum output frequency of 100.00, set parameters to these values:

- $o1-10 = 10000$
- $o1-11 = 2$ [User Units Decimal Position = Two Decimal Places (XXX.XX)]

Note:

Set $o1-03 = 3$ [Frequency Display Unit Selection = User Units ($o1-10$ & $o1-11$)] before you set $o1-10$ and $o1-11$.

■ o1-11: User Units Decimal Position

No. (Hex.)	Name	Description	Default (Range)
o1-11 (0521)	User Units Decimal Position	V/f CL-V/f OLV CLV AOLV OLV/PM AOLV/PM CLV/PM EZOLV Sets the number of decimal places for frequency reference and monitor values.	Determined by o1-03 (0 - 3)

0 : No Decimal Places (XXXXX)

1 : One Decimal Places (XXXX.X)

2 : Two Decimal Places (XXX.XX)

3 : Three Decimal Places (XX.XXX)

Note:

Set $o1-03 = 3$ [Frequency Display Unit Selection = User Units ($o1-10$ & $o1-11$)] before you set $o1-10$ [User Units Maximum Value] and $o1-11$.

■ o1-24 to o1-35: Custom Monitor 1 to 12

No. (Hex.)	Name	Description	Default (Range)
o1-24 to o1-35 (11AD - 11B8) RUN	Custom Monitor 1 to 12	V/f CL-V/f OLV CLV AOLV OLV/PM AOLV/PM CLV/PM EZOLV Sets a maximum of 12 monitors ($Ux-xx$) as user monitors. This parameter is only available when you use an LCD keypad.	o1-24: 101 o1-25: 102 o1-26: 103 o1-27 to o1-35: 0 (0, 101 - 9999)

These parameters save the monitor items selected by the LCD keypad [Custom Monitor].

Note:

- Set the $x-xx$ part of the $Ux-xx$ [Monitor]. For example, set $o1-24 = 102$ to monitor $U1-02$ [Output Frequency].
When the x part of Ux is a letter, replace the letter (hexadecimal number) with a decimal number. For example, set $o1-24 = 1301$ to monitor $Ud-01$.
- You can show a maximum of three selected monitors on one LCD keypad screen.
 - When you select only one monitor, the text size of this monitor increases. For example, when $o1-25$ to $o1-35 = 0$, the text size of the monitor saved in $o1-24$ increases.
 - When you select two monitors, the text size of these monitors increase.
 - When you select four or more monitors, the keypad shows the fourth monitor and all additional monitors on the next screens.
- You can show monitors selected with $o1-24$ to $o1-26$ as a bar graph, analog gauge, or trend plot.
 - Bar graph display: 3 monitors maximum
Select with $o1-24$, $o1-25$, and $o1-26$.
 - Analog gauge display: 1 monitor
Select with $o1-24$.
 - Trend plot display: 2 monitors
Select with $o1-24$ and $o1-25$.
- You can only set parameters $o1-24$ to $o1-26$ with analog output monitors.
- You can set all monitors to parameters $o1-27$ to $o1-35$.

■ o1-36: LCD Backlight Brightness

No. (Hex.)	Name	Description	Default (Range)
o1-36 (11B9) RUN	LCD Backlight Brightness	V/f CL-V/f OLV CLV AOLV OLV/PM AOLV/PM CLV/PM EZOLV Sets the intensity of the LCD keypad backlight.	3 (1 - 5)

When you decrease the setting value, the intensity of the backlight decreases.

o1-37: LCD Backlight ON/OFF Selection

No. (Hex.)	Name	Description	Default (Range)
o1-37 (11BA) RUN	LCD Backlight ON/OFF Selection	 Sets the automatic shut off function for the LCD backlight.	1 (0, 1)

Note:

Use o1-36 [LCD Backlight Brightness] to adjust the intensity of the LCD backlight.

0 : OFF

The backlight will automatically turn off after the time set in o1-38 [LCD Backlight Off-Delay] is expired.

When the backlight is off, push a key on the keypad to temporarily turn the backlight on. After the backlight turns on, it will turn off automatically after the time set in o1-38 is expired.

Note:

When the backlight is off, push a key on the keypad to temporarily turn the backlight on. Push any key to start keypad operation. Push



to turn the backlight on, then push again to enter a Run command to the drive.

1 : ON

The backlight will always be ON.

o1-38: LCD Backlight Off-Delay

No. (Hex.)	Name	Description	Default (Range)
o1-38 (11BB) RUN	LCD Backlight Off-Delay	 Sets the time until the LCD backlight automatically turns off.	60 s (10 - 300 s)

When o1-37 = 0 [LCD Backlight ON/OFF Selection = OFF], the backlight will automatically turn off after the time set in o1-38 expires.

When the backlight is off, push a key on the keypad to temporarily turn the backlight on. After the backlight turns on, it will turn off automatically after the time set in o1-38 is expired.

o1-39: Show Initial Setup Screen

No. (Hex.)	Name	Description	Default (Range)
o1-39 (11BC) RUN	Show Initial Setup Screen	 Sets the function to show the LCD keypad initial setup screen each time you energize the drive. This parameter is only available with an LCD keypad.	1 (0, 1)

The initial setup screen shows a menu where you can select the display language, set the date, time, and other basic settings. When you set this parameter to 0, the drive will not show this screen each time you energize the drive.

0 : No

The drive will not show the initial setup display screen each time you energize the drive. The drive will show the Home screen.

1 : Yes

When you input the Run command before you energize the drive or when you turn on the Run command while the drive shows the initial setup screen, the drive will replace the initial setup screen with the Home screen.

o1-40: Home Screen Display Selection

No. (Hex.)	Name	Description	Default (Range)
o1-40 (11BD) RUN	Home Screen Display Selection	 Sets the monitor display mode for the Home screen. This parameter is only available with an LCD keypad.	0 (0 - 3)

0 : Custom Monitor

1 : Bar Graph

2 : Analog Gauge

3 : Trend Plot

■ o1-41: 1st Monitor Area Selection

No. (Hex.)	Name	Description	Default (Range)
o1-41 (11C1) RUN	1st Monitor Area Selection	V/f CL-V/f OLV CLV AOLV OLV/PM AOLV/PM CLV/PM EZOLV Sets the horizontal axis value used to display the monitor set in o1-24 [Custom Monitor 1] as a bar graph. This parameter is only available with an LCD keypad.	0 (0 - 1)

0 : +/- Area (- o1-42 ~ o1-42)

1 : + Area (0 ~ o1-42)

■ o1-42: 1st Monitor Area Setting

No. (Hex.)	Name	Description	Default (Range)
o1-42 (11C2) RUN	1st Monitor Area Setting	V/f CL-V/f OLV CLV AOLV OLV/PM AOLV/PM CLV/PM EZOLV Sets the horizontal axis value used to display the monitor set in o1-24 [Custom Monitor 1] as a bar graph. This parameter is only available with an LCD keypad.	100.0% (0.0 - 100.0%)

■ o1-43: 2nd Monitor Area Selection

No. (Hex.)	Name	Description	Default (Range)
o1-43 (11C3) RUN	2nd Monitor Area Selection	V/f CL-V/f OLV CLV AOLV OLV/PM AOLV/PM CLV/PM EZOLV Selects the horizontal range used to display the monitor set in o1-25 [Custom Monitor 2] as a bar graph. This parameter is only available with an LCD keypad.	0 (0 - 1)

0 : +/- Area (- o1-44 ~ o1-44)

1 : + Area (0 ~ o1-44)

■ o1-44: 2nd Monitor Area Setting

No. (Hex.)	Name	Description	Default (Range)
o1-44 (11C4) RUN	2nd Monitor Area Setting	V/f CL-V/f OLV CLV AOLV OLV/PM AOLV/PM CLV/PM EZOLV Sets the horizontal axis value used to display the monitor set in o1-25 [Custom Monitor 2] as a bar graph. This parameter is only available with an LCD keypad.	100.0% (0.0 - 100.0%)

■ o1-45: 3rd Monitor Area Selection

No. (Hex.)	Name	Description	Default (Range)
o1-45 (11C5) RUN	3rd Monitor Area Selection	V/f CL-V/f OLV CLV AOLV OLV/PM AOLV/PM CLV/PM EZOLV Sets the horizontal axis value used to display the monitor set in o1-26 [Custom Monitor 3] as a bar graph. This parameter is only available with an LCD keypad.	0 (0 - 1)

0 : +/- Area (- o1-46 ~ o1-46)

1 : + Area (0 ~ o1-46)

■ o1-46: 3rd Monitor Area Setting

No. (Hex.)	Name	Description	Default (Range)
o1-46 (11C6) RUN	3rd Monitor Area Setting	V/f CL-V/f OLV CLV AOLV OLV/PM AOLV/PM CLV/PM EZOLV Sets the horizontal axis value used to display the monitor set in o1-26 [Custom Monitor 3] as a bar graph. This parameter is only available with an LCD keypad.	100.0% (0.0 - 100.0%)

■ o1-47: Trend Plot 1 Scale Minimum Value

No. (Hex.)	Name	Description	Default (Range)
o1-47 (11C7) RUN	Trend Plot 1 Scale Minimum Value	V/f CL-V/f OLV CLV AOLV OLV/PM AOLV/PM CLV/PM EZOLV Sets the horizontal axis minimum value used to display the monitor set in o1-24 [Custom Monitor 1] as a trend plot. This parameter is only available with an LCD keypad.	-100.0% (-300.0 - +299.9%)

Note:

Parameter *o1-48* [Trend Plot 1 Scale Maximum Value] sets the upper limit. The upper limit is (*o1-48* - 0.1)%.

■ o1-48: Trend Plot 1 Scale Maximum Value

No. (Hex.)	Name	Description	Default (Range)
o1-48 (11C8) RUN	Trend Plot 1 Scale Maximum Value	V/f CL-V/f OLV CLV AOLV OLV/PM AOLV/PM CLV/PM EZOLV Sets the maximum value for the vertical axis used to display the monitor that was set in <i>o1-24</i> [Custom Monitor 1] as a trend plot. This parameter is only available with an LCD keypad.	100.0% (-299.9 - +300.0%)

Note:

Parameter *o1-47* [Trend Plot 1 Scale Minimum Value] sets the lower limit. The lower limit is (*o1-47* + 0.1)%.

■ o1-49: Trend Plot 2 Scale Minimum Value

No. (Hex.)	Name	Description	Default (Range)
o1-49 (11C9) RUN	Trend Plot 2 Scale Minimum Value	V/f CL-V/f OLV CLV AOLV OLV/PM AOLV/PM CLV/PM EZOLV Sets the horizontal axis minimum value used to display the monitor set in <i>o1-25</i> [Custom Monitor 2] as a trend plot. This parameter is only available with an LCD keypad.	-100.0% (-300.0 - +299.9%)

Note:

Parameter *o1-50* [Trend Plot 2 Scale Maximum Value] sets the upper limit. The upper limit is (*o1-50* - 0.1)%.

■ o1-50: Trend Plot 2 Scale Maximum Value

No. (Hex.)	Name	Description	Default (Range)
o1-50 (11CA) RUN	Trend Plot 2 Scale Maximum Value	V/f CL-V/f OLV CLV AOLV OLV/PM AOLV/PM CLV/PM EZOLV Sets the maximum value for the vertical axis used to display the monitor that was set in <i>o1-25</i> [Custom Monitor 2] as a trend plot. This parameter is only available with an LCD keypad.	100.0% (-299.9 - +300.0%)

Note:

Parameter *o1-49* [Trend Plot 2 Scale Minimum Value] sets the lower limit. The lower limit is (*o1-49* + 0.1)%.

■ o1-51: Trend Plot Time Scale Setting

No. (Hex.)	Name	Description	Default (Range)
o1-51 (11CB) RUN	Trend Plot Time Scale Setting	V/f CL-V/f OLV CLV AOLV OLV/PM AOLV/PM CLV/PM EZOLV Sets the time scale (horizontal axis) to display the trend plot. When you change this setting, the drive automatically adjusts the data sampling time. This parameter is only available with an LCD keypad.	300 s (1 - 3600 s)

■ o1-55: Analog Gauge Area Selection

No. (Hex.)	Name	Description	Default (Range)
o1-55 (11EE) RUN	Analog Gauge Area Selection	V/f CL-V/f OLV CLV AOLV OLV/PM AOLV/PM CLV/PM EZOLV Sets the range used to display the monitor set in <i>o1-24</i> [Custom Monitor 1] as an analog gauge. This parameter is only available with an LCD keypad.	1 (0, 1)

0 : +/- Area (- o1-56 ~ o1-56)

1 : + Area (0 ~ o1-56)

■ o1-56: Analog Gauge Area Setting

No. (Hex.)	Name	Description	Default (Range)
o1-56 (11EF) RUN	Analog Gauge Area Setting	V/f CL-V/f OLV CLV AOLV OLV/PM AOLV/PM CLV/PM EZOLV Sets the value used to display the monitor set in <i>o1-24</i> [Custom Monitor 1] as an analog meter. This parameter is only available with an LCD keypad.	100.0% (0.0 - 100.0%)

■ **o1-58: Motor Power Unit Selection**

No. (Hex.)	Name	Description	Default (Range)
o1-58 (3125)	Motor Power Unit Selection	V/f CL-V/f OLV CLV AOLV OLV/PM AOLV/PM CLV/PM EZOLV Sets the setting unit for parameters that set the motor rated power.	0 (0, 1)

The drive shows these parameter values in the set units:

- E2-11 [Motor Rated Power]
- E4-11 [Motor 2 Rated Power]
- E5-02 [PM Motor Rated Power]
- E9-07 [Motor Rated Power]
- T1-02 [Motor Rated Power]
- T2-04 [PM Motor Rated Power]
- T4-08 [Motor Rated Capacity]

0 : kW

Shows the motor output in kW units.

1 : HP

Shows the motor output in HP units.

◆ **o2: Keypad Operation**

■ **o2-01: LO/RE Key Function Selection**

No. (Hex.)	Name	Description	Default (Range)
o2-01 (0505)	LO/RE Key Function Selection	V/f CL-V/f OLV CLV AOLV OLV/PM AOLV/PM CLV/PM EZOLV Sets the function that lets you use LO/RE to switch between LOCAL and REMOTE Modes.	1 (0, 1)

0 : Disabled

You cannot use **LO/RE** to switch between LOCAL and REMOTE Modes.

1 : Enabled

You can use **LO/RE** to switch between LOCAL and REMOTE Modes when the drive is stopped. When LOCAL Mode is selected, **LO/RE** on the keypad will come on.

WARNING! Sudden Movement Hazard. If you change the control source when b1-07 = 1 [LOCAL/REMOTE Run Selection = Accept Existing RUN Command], the drive can start suddenly. Before you change the control source, remove all personnel from the area around the drive, motor, and load. Sudden starts can cause serious injury or death.

WARNING! Sudden Movement Hazard. Fully examine all mechanical and electrical connections before you change o2-01 [LO/RE Key Function Selection] or b1-07 [LOCAL/REMOTE Run Selection]. Sudden starts can cause serious injury or death. If b1-07 = 1 [Accept Existing RUN Command] and there is an active Run command when you switch from LOCAL to REMOTE Mode, the drive can start suddenly.

Table 12.80 Function Settings with o2-01 and b1-07

LO/RE Function Selection	LOCAL/REMOTE Run Selection	Switching from LOCAL Mode to REMOTE Mode	Switching from REMOTE Mode to LOCAL Mode
o2-01 = 0 [Disabled]	b1-07 = 0 [Disregard Existing RUN Command]	The drive will not switch modes.	The drive will not switch modes.
	b1-07 = 1 [Accept Existing RUN Command]		
o2-01 = 1 [Enabled]	b1-07 = 0 [Disregard Existing RUN Command]	The drive will not start operating although the Run command is active. When you set Run command to active again, the drive will start to run.	The drive cannot operate because the Run command is not enabled.
	b1-07 = 1 [Accept Existing RUN Command]	When the Run command is active, the drive will start to run immediately when the mode switches from LOCAL to REMOTE.	The drive cannot operate because the Run command is not enabled.

o2-02: STOP Key Function Selection

No. (Hex.)	Name	Description	Default (Setting Range)
o2-02 (0506)	STOP Key Function Selection	<div style="display: flex; justify-content: space-between; font-size: 0.8em;"> V/f CL-V/f OLV CLV AOLV OLV/PM AOLV/PM CLV/PM EZOLV </div> <p>Sets the function to use  on the keypad to stop the drive when the Run command source for the drive is REMOTE (external) and not assigned to the keypad.</p>	1 (0, 1)

0 : Disabled

1 : Enabled

 stays enabled when the Run command source has not been assigned to the keypad.

To start the drive again after you push  to stop operation, turn the external Run command OFF and ON again.

o2-03: User Parameter Default Value

No. (Hex.)	Name	Description	Default (Range)
o2-03 (0507)	User Parameter Default Value	<div style="display: flex; justify-content: space-between; font-size: 0.8em;"> V/f CL-V/f OLV CLV AOLV OLV/PM AOLV/PM CLV/PM EZOLV </div> <p>Sets the function to keep the settings of changed parameters as user parameter defaults to use during initialization.</p>	0 (0 - 2)

When you set $o2-03 = 1$ [*Set defaults*], the drive saves changed parameter settings as user parameter setting values in a part of the memory that is isolated from drive parameters.

When you set $A1-03 = 1110$ [*Initialize Parameters = User Initialization*] to initialize the drive, the drive resets the internal parameter setting values to those user parameter setting values.

0 : No change

1 : Set defaults

Saves changed parameter setting values as user default settings.

Set $o2-03 = 1$ then push  to save the user parameter setting values. After the drive saves the setting value, $o2-03$ automatically resets to 0.

2 : Clear all

Deletes all of the saved user parameter setting values.

Set $o2-03 = 2$ then push  to clear the user parameter setting values. The drive will automatically reset $o2-03$ to 0. If you delete the user parameter setting values, you cannot set $A1-03 = 1110$ to initialize parameters.

o2-04: Drive Model (KVA) Selection

No. (Hex.)	Name	Description	Default (Range)
o2-04 (0508)	Drive Model (KVA) Selection	<div style="display: flex; justify-content: space-between; font-size: 0.8em;"> V/f CL-V/f OLV CLV AOLV OLV/PM AOLV/PM CLV/PM EZOLV </div> <p>Sets the Drive Model code. Set this parameter after replacing the control board.</p>	Determined by the drive (-)

NOTICE: Set $o2-04$ [*Drive Model (KVA) Selection*] correctly. If you set this parameter incorrectly, it will decrease drive performance, cause the protection function to operate incorrectly, and cause damage to the drive.

Note:

When the setting value of $o2-04$ changes, related parameter setting values also change. Refer to [Defaults by Drive Model and Duty Rating ND/HD on page 637](#) for more information.

These tables list the relation between $o2-04$ setting values and drive models.

Table 12.81 Three-Phase 200 V Class

Drive Model	o2-04 Setting	Drive Model	o2-04 Setting
2004	62	2030	6A
2006	63	2042	6B
2010	65	2056	6D
2012	66	2070	6E
2018	67	2082	6F
2021	68	2110	70

Drive Model	o2-04 Setting
2138	72
2169	73
2211	74
2257	75

Drive Model	o2-04 Setting
2313	76
2360	77
2415	78

Table 12.82 Three-Phase 400 V Class

Drive Model	o2-04 Setting
4002	92
4004	93
4005	94
4007	95
4009	96
4012	97
4018	99
4023	9A
4031	9C
4038	9D
4044	9E
4060	9F
4075	A1
4089	A2
4103	A3

Drive Model	o2-04 Setting
4140	A4
4168	A5
4208	A6
4250	A7
4296	A8
4371	A9
4389	AA
4453	AC
4568	AD
4675	AE
4810	B0
4930	B1
4H11	B2
4H12	B3



■ o2-05: Home Mode Freq Ref Entry Mode

No. (Hex.)	Name	Description	Default (Setting Range)
o2-05 (0509)	Home Mode Freq Ref Entry Mode	<div style="display: flex; justify-content: space-between; font-size: small;"> V/f CL-V/f OLV CLV AOLV OLV/PM AOLV/PM CLV/PM EZOLV </div> <p>Sets the function that makes it necessary to push  to use the keypad to change the frequency reference value while in Drive Mode.</p>	0 (0, 1)

0 : ENTER Key Required

You must push  to use the keypad to change the frequency reference value.

1 : Immediate / MOP-style

The frequency reference changes when you enter it with the keypad. This then changes the output frequency. It is not necessary to push . The drive keeps the frequency reference for 5 seconds after you use  and  on the keypad to change the frequency reference value.

■ o2-06: Keypad Disconnect Detection

No. (Hex.)	Name	Description	Default (Range)
o2-06 (050A)	Keypad Disconnect Detection	<div style="display: flex; justify-content: space-between; font-size: small;"> V/f CL-V/f OLV CLV AOLV OLV/PM AOLV/PM CLV/PM EZOLV </div> <p>Sets the function that stops the drive if you disconnect the keypad connection cable from the drive or if you damage the cable while the keypad is the Run command source.</p>	0 (0, 1)

This parameter continues to operate if the keypad installed to the drive becomes disconnected.

This parameter is enabled in these conditions:

- When $b1-02 = 0$ [Run Command Selection 1 = Keypad] or $b1-16 = 0$ [Run Command Selection 2 = Keypad]
- In LOCAL Mode

0 : Disabled

The drive continues operation when it detects a keypad disconnection.

1 : Enabled

The drive stops operation, detects *oPr* [Keypad Connection Fault], and the motor coasts to stop when the drive detects a keypad disconnection.

■ o2-07: Keypad RUN Direction @ Power-up

No. (Hex.)	Name	Description	Default (Range)
o2-07 (0527)	Keypad RUN Direction @ Power-up	V/f CL-V/f OLV CLV AOLV OLV/PM AOLV/PM CLV/PM EZOLV Sets the direction of motor rotation when the drive is energized and the keypad is the Run command source.	0 (0, 1)

This parameter is enabled in these conditions:

- When $b1-02 = 0$ [Run Command Selection 1 = Keypad] or $b1-16 = 0$ [Run Command Selection 2 = Keypad]
- In LOCAL Mode

0 : Forward

1 : Reverse

■ o2-09: Reserved

No. (Hex.)	Name	Description	Default (Range)
o2-09 (050D)	Reserved	-	-

■ o2-23: External 24V Powerloss Detection

No. (Hex.)	Name	Description	Default (Setting Range)
o2-23 (11F8) RUN	External 24V Powerloss Detection	V/f CL-V/f OLV CLV AOLV OLV/PM AOLV/PM CLV/PM EZOLV Sets the function to give a warning if the backup external 24 V power supply turns off when the main circuit power supply is in operation.	0 (0, 1)

Note:

The drive will not run when it is operating from one 24-V external power supply.

0 : Disabled

The drive does not detect the loss of the 24-V external power supply.

1 : Enabled

The keypad shows the *L24v* [Loss of External Power 24 Supply] indicator if the drive detects the loss of the 24-V external power supply.

Note:

A minor fault signal is not output from $H2-xx = 10$ [MFDO Function Selection = Alarm].

■ o2-24: LED Light Function Selection

No. (Hex.)	Name	Description	Default (Setting Range)
o2-24 (11FE)	LED Light Function Selection	V/f CL-V/f OLV CLV AOLV OLV/PM AOLV/PM CLV/PM EZOLV Sets the function to show the LED status rings and keypad LED lamps.	0 (0 - 2)

0 : Enable Status Ring & Keypad LED

1 : LED Status Ring Disable

2 : Keypad LED Light Disable

■ o2-26: Alarm Display at Ext. 24V Power

No. (Hex.)	Name	Description	Default (Range)
o2-26 (1563)	Alarm Display at Ext. 24V Power	V/f CL-V/f OLV CLV AOLV OLV/PM AOLV/PM CLV/PM EZOLV When you connect a backup external 24 V power supply, this parameter sets the function to trigger an alarm when the main circuit power supply voltage decreases.	0 (0, 1)

0 : Disabled

The drive will not detect *EP24v* [External Power 24V Supply] if the main circuit power supply voltage decreases. The [Ready] light on the LED Status Ring flashes quickly to identify that drive operation is not possible.

1 : Enabled

The drive detects *EP24v* when the main circuit power supply voltage decreases.

Note:

A minor fault signal is not output from *H2-xx = 10* [*MFDO Function Selection = Alarm*].

■ **o2-27: bCE Detection Selection**

No. (Hex.)	Name	Description	Default (Range)
o2-27 (1565)	bCE Detection Selection	<div style="display: flex; justify-content: space-between; font-size: 0.8em; font-weight: bold; background-color: #f0f0f0; padding: 2px;"> V/f CL-V/f OLV CLV AOLV OLV/PM AOLV/PM CLV/PM EZOLV </div> <p>Sets drive operation if the Bluetooth device is disconnected when you operate the drive in Bluetooth Mode.</p>	3 (0 - 4)

0 : Ramp to Stop

1 : Coast to Stop

2 : Fast Stop (Use C1-09)

3 : Alarm Only

4 : No Alarm Display

■ **o2-33: Initial Pole Detection (External 24 V Power Supply)**

No. (Hex.)	Name	Description	Default (Range)
o2-33 (1BB6) Expert	Initial Pole Detection (External 24 V Power Supply)	<div style="display: flex; justify-content: space-between; font-size: 0.8em; font-weight: bold; background-color: #f0f0f0; padding: 2px;"> V/f CL-V/f OLV CLV AOLV OLV/PM AOLV/PM CLV/PM EZOLV </div> <p>Sets initial pole detection during the first run after an external 24 V power supply energizes the main circuit. While the main circuit is energized, the drive does not do initial pole detection from the second Run command. Usually it is not necessary to change this setting.</p>	1 (0, 1)

0 : Initial pole detection disabled

1 : Initial pole detection enabled

◆ **o3: Copy Function**

o3 parameters set the operation of the parameter backup function.

■ **o3-01: Copy Keypad Function Selection**

No. (Hex.)	Name	Description	Default (Range)
o3-01 (0515)	Copy Keypad Function Selection	<div style="display: flex; justify-content: space-between; font-size: 0.8em; font-weight: bold; background-color: #f0f0f0; padding: 2px;"> V/f CL-V/f OLV CLV AOLV OLV/PM AOLV/PM CLV/PM EZOLV </div> <p>Sets the function that saves and copies drive parameters to a different drive with the keypad.</p>	0 (0 - 4)

0 : Copy Select

1 : Backup (drive → keypad)

The parameter setting values are read from the drive and saved in the keypad.

2 : Restore (keypad → drive)

Copies the parameter setting values saved in the keypad to a different drive.

3 : Verify (check for mismatch)

Makes sure that the parameter setting values in the drive agree with the parameters saved in the keypad.

4 : Erase (backup data of keypad)

Deletes the parameter setting values saved in the keypad.

■ **o3-02: Copy Allowed Selection**

No. (Hex.)	Name	Description	Default (Range)
o3-02 (0516)	Copy Allowed Selection	<div style="display: flex; justify-content: space-between; font-size: 0.8em; font-weight: bold; background-color: #f0f0f0; padding: 2px;"> V/f CL-V/f OLV CLV AOLV OLV/PM AOLV/PM CLV/PM EZOLV </div> <p>Sets the copy function when <i>o3-01 = 1</i> [<i>Copy Keypad Function Selection = Backup (drive → keypad)</i>].</p>	0 (0, 1)

Note:

When you select [Parameter Backup] on the keypad menu screen to do the backup function, the drive automatically sets *o3-02 = 1*.

0 : Disabled

1 : Enabled**■ o3-04: Select Backup/Restore Location**

No. (Hex.)	Name	Description	Default (Range)
o3-04 (0B3E)	Select Backup/Restore Location	V/f CL-V/f OLV CLV AOLV OLV/PM AOLV/PM CLV/PM EZOLV Sets the storage location for drive parameters when you back up and restore parameters. This parameter is only available when using an LCD keypad.	0 (0 - 3)

You can use the LCD keypad to make a maximum of 4 parameter backup sets.

0 : Memory Location 1**1 : Memory Location 2****2 : Memory Location 3****3 : Memory Location 4****■ o3-05: Select Items to Backup/Restore**

No. (Hex.)	Name	Description	Default (Range)
o3-05 (0BDA)	Select Items to Backup/Restore	V/f CL-V/f OLV CLV AOLV OLV/PM AOLV/PM CLV/PM EZOLV Sets which parameters are backed up, restored, and referenced. This parameter is only available when using an LCD keypad.	0 (0, 1)

0 : Standard Parameters**1 : Standard + DWEZ Parameters****Note:**

- Parameters *qx-xx* [DriveWorksEZ Parameters] and *rx-xx* [DriveWorksEZ Connections] show when *A1-07 = 1 or 2* [DriveWorksEZ Function Selection = DWEZ Enabled or Enabled/Disabled wDigital Input].
- The password for DriveWorksEZ PC software is necessary to back up *qx-xx* and *rx-xx*. If you enter an incorrect password, the drive detects *PWEr* [DWEZ Password Mismatch].

■ o3-06: Auto Parameter Backup Selection

No. (Hex.)	Name	Description	Default (Range)
o3-06 (0BDE)	Auto Parameter Backup Selection	V/f CL-V/f OLV CLV AOLV OLV/PM AOLV/PM CLV/PM EZOLV Sets the function that automatically backs up parameters. This parameter is only available when using an LCD keypad.	1 (0, 1)

When you connect the drive and keypad, parameters set to the drive are automatically backed up to the keypad as specified by the setting of parameters *o3-06* and *o3-07*.

0 : Disabled**1 : Enabled****Note:**

When you replace the LCD keypad then energize the drive, the keypad shows the restore operation screen automatically to restore the drive configuration with the parameters backed up to the LCD keypad. If you connect an LCD keypad that does not have parameter backup data, the keypad will not show the restore operation screen.

■ o3-07: Auto Parameter Backup Interval

No. (Hex.)	Name	Description	Default (Range)
o3-07 (0BDF)	Auto Parameter Backup Interval	V/f CL-V/f OLV CLV AOLV OLV/PM AOLV/PM CLV/PM EZOLV Sets the interval at which the automatic parameter backup function saves parameters from the drive to the keypad.	1 (0 - 3)

The drive saves parameter settings to the keypad at these times:

- After you energize the drive and the auto backup period passes.
- When you use ROM enter or the keypad to change parameters, the drive saves those changes in the drive, waits for the auto backup period to pass, then saves those parameters in the keypad.

Note:

The drive can write data to the keypad a maximum of 100,000 times. If you write data to the keypad more than 100,000 times, you must replace the keypad.

0 : Every 10 minutes

- 1 : Every 30 minutes
- 2 : Every 60 minutes
- 3 : Every 12 hours

◆ o4: Maintenance Mon Settings

o4 parameters set the expected service life to help you know when to replace parts. The drive will show an alarm to tell you when the replacement part interval is near.

■ o4-01: Elapsed Operating Time Setting

No. (Hex.)	Name	Description	Default (Range)
o4-01 (050B)	Elapsed Operating Time Setting	V/f CL-V/f OLV CLV AOLV OLV/PM AOLV/PM CLV/PM EZOLV Sets the initial value of the cumulative drive operation time in 10-hour units.	0 h (0 - 9999 h)

When you select *o4-01* on the keypad, it will show the current value of *U4-01* in units of 10 hours (h). When you change the setting of *o4-01* through the monitor, the *U4-01* count starts again as specified by the setting of *o4-01*.

Note:

Set this parameter in 10-hour (h) units. When *o4-01* = 30, *U4-01* [Cumulative Ope Time] = 300 h.

■ o4-02: Elapsed Operating Time Selection

No. (Hex.)	Name	Description	Default (Range)
o4-02 (050C)	Elapsed Operating Time Selection	V/f CL-V/f OLV CLV AOLV OLV/PM AOLV/PM CLV/PM EZOLV Sets the condition that counts the cumulative operation time.	0 (0, 1)

0 : U4-01 Shows Total Power-up Time

Counts the time from when the drive is energized to when it is de-energized.

1 : U4-01 Shows Total RUN Time

Counts the time that the drive outputs voltage.

■ o4-03: Fan Operation Time Setting

No. (Hex.)	Name	Description	Default (Range)
o4-03 (050E)	Fan Operation Time Setting	V/f CL-V/f OLV CLV AOLV OLV/PM AOLV/PM CLV/PM EZOLV Sets the value from which to start the cumulative drive cooling fan operation time in 10-hour units.	0 h (0 - 9999 h)

Use monitor *U4-03* [Cooling Fan Ope Time] to view the total operation time of the cooling fan. When you replace a cooling fan, set *o4-03* = 0 to reset *U4-03*. Select *o4-03* on the keypad to show the current value of *U4-03* in 10-hour (h) units. If you use the monitor to change *o4-03*, the recount of *U4-03* starts with the *o4-03* setting.

Note:

The drive sets *o4-03* in 10-hour (h) units. When *o4-03* = 30, *U4-03* [Cooling Fan Ope Time] will show “300 h”.

■ o4-05: Capacitor Maintenance Setting

No. (Hex.)	Name	Description	Default (Range)
o4-05 (051D)	Capacitor Maintenance Setting	V/f CL-V/f OLV CLV AOLV OLV/PM AOLV/PM CLV/PM EZOLV Sets the <i>U4-05</i> [Capacitor Maintenance] monitor value.	0% (0 - 150%)

When you replace a drive, set *o4-05* = 0 to reset *U4-05*. When the *o4-05* setting changes, the count of *U4-05* starts again as specified by the setting of *o4-05*. After you complete the configuration, *o4-05* automatically resets to 0.

Note:

The maintenance period changes for different operating environments.

■ o4-07: Softcharge Relay Maintenance Set

No. (Hex.)	Name	Description	Default (Range)
o4-07 (0523)	Softcharge Relay Maintenance Set	V/f CL-V/f OLV CLV AOLV OLV/PM AOLV/PM CLV/PM EZOLV Sets the U4-06 [PreChargeRelayMainte] monitor value.	0% (0 - 150%)

When you replace a drive, set *o4-07* = 0 to reset *U4-06*. When the *o4-07* setting changes, the count of *U4-06* starts again as specified by the setting of *o4-07*. After you complete the configuration, *o4-07* automatically resets to 0.

Note:

The maintenance period changes for different operating environments.

■ o4-09: IGBT Maintenance Setting

No. (Hex.)	Name	Description	Default (Range)
o4-09 (0525)	IGBT Maintenance Setting	V/f CL-V/f OLV CLV AOLV OLV/PM AOLV/PM CLV/PM EZOLV Sets the U4-07 [IGBT Maintenance] monitor value.	0% (0 - 150%)

When you replace a drive, set *o4-09* = 0 to reset *U4-07*. When the *o4-09* setting changes, the count of *U4-07* starts again as specified by the setting of *o4-09*. After you complete the configuration, *o4-09* automatically resets to 0.

Note:

The maintenance period changes for different operating environments.

■ o4-11: Fault Trace/History Init (U2/U3)

No. (Hex.)	Name	Description	Default (Range)
o4-11 (0510)	Fault Trace/History Init (U2/U3)	V/f CL-V/f OLV CLV AOLV OLV/PM AOLV/PM CLV/PM EZOLV Resets the records of Monitors U2-xx [Fault Trace] and U3-xx [Fault History].	0 (0, 1)

Note:

When you initialize the drive with *A1-03* [Initialize Parameters], the drive will not reset the records for *U2-xx* and *U3-xx*.

0 : Disabled

Keeps the records of Monitors *U2-xx* and *U3-xx*.

1 : Enabled

Resets the records for Monitors *U2-xx* and *U3-xx*. After the reset, the drive automatically resets *o4-11* to 0.

■ o4-12: kWh Monitor Initialization

No. (Hex.)	Name	Description	Default (Range)
o4-12 (0512)	kWh Monitor Initialization	V/f CL-V/f OLV CLV AOLV OLV/PM AOLV/PM CLV/PM EZOLV Resets the monitor values for <i>U4-10</i> [kWh, Lower 4 Digits] and <i>U4-11</i> [kWh, Upper 5 Digits].	0 (0, 1)

Note:

When you initialize the drive with *A1-03* [Initialize Parameters], the drive will not reset *U4-10* and *U4-11*.

0 : No Reset

Keeps the monitor values for *U4-10* and *U4-11*.

1 : Reset

Resets the values of *U4-10* and *U4-11*. After the reset, the drive automatically resets *o4-12* to 0.

■ o4-13: RUN Command Counter @ Initialize

No. (Hex.)	Name	Description	Default (Range)
o4-13 (0528)	RUN Command Counter @ Initialize	V/f CL-V/f OLV CLV AOLV OLV/PM AOLV/PM CLV/PM EZOLV Resets the monitor values for <i>U4-02</i> [Num of Run Commands], <i>U4-24</i> [Number of Runs (Low)], and <i>U4-25</i> [Number of Runs (High)].	0 (0, 1)

0 : No Reset

Keeps the monitor values for *U4-02*, *U4-24*, and *U4-25*.

1 : Reset

Resets the values of *U4-02*, *U4-24*, and *U4-25*. After the reset, the drive automatically resets *o4-13* to *0*.

■ o4-22: Time Format

No. (Hex.)	Name	Description	Default (Range)
o4-22 (154F) RUN	Time Format	V/f CL-V/f OLV CLV AOLV OLV/PM AOLV/PM CLV/PM EZOLV Sets the time display format. This parameter is only available when using an LCD keypad.	0 (0 - 2)

Sets the display of the time shown in the upper-left of the LCD keypad screen.

0 : 24 Hour Clock**1 : 12 Hour Clock****2 : 12 Hour JP Clock****■ o4-23: Date Format**

No. (Hex.)	Name	Description	Default (Range)
o4-23 (1550) RUN	Date Format	V/f CL-V/f OLV CLV AOLV OLV/PM AOLV/PM CLV/PM EZOLV Sets the date display format. This parameter is only available when using an LCD keypad.	0 (0 - 2)

Sets the date format that the drive uses for the fault history and other records.

0 : YYYY/MM/DD**1 : DD/MM/YYYY****2 : MM/DD/YYYY****Note:**

The Fault History in the Monitor Mode shows when faults occurred. Refer to [Show Fault History on page 184](#) for more information.

■ o4-24: bAT Detection Selection

No. (Hex.)	Name	Description	Default (Range)
o4-24 (310F) RUN	bAT Detection Selection	V/f CL-V/f OLV CLV AOLV OLV/PM AOLV/PM CLV/PM EZOLV Sets operation when the drive detects <i>bAT</i> [Keypad Battery Low Voltage] and <i>TiM</i> [Keypad Time Not Set].	0 (0 - 2)

0 : Disable

The drive will not detect *bAT* or *TiM*.

1 : Enable (Alarm Detected)

TiM or *bAT* shows on the keypad, and operation continues. The output terminal set for Alarm [*H2-01* to *H2-03* = *10*] activates.

2 : Enable (Fault Detected)

The drive output shuts off and the motor coasts to stop. Fault relay output terminal MA-MC activates, and MB-MC deactivates.

◆ o5: Log Function

The data log function saves drive status information as a CSV file in the microSD memory card in the keypad. Monitors *Ux-xx* are the source of data log information.

There are two types of data log functions:

- Long-term data log: Saves data continuously over an extended time period.
- Short-term data log: Saves data over a set length of time before and after the drive detects a trigger event with a short sampling cycle.

You can record a maximum of 10 monitors for long-term data logs and a maximum of four monitors for short-term data logs.

[Table 12.83](#) shows the keypads that support the short-term data log function.

Note:

- The short-term data log function is available in drive software versions PRG: 01034 and later.
- The “PRG” column on the nameplate on the right side of the drive identifies the software version. You can also use *UI-25 [SoftwareNumber Flash]* to identify the software version.

Table 12.83 Compatible Keypads with Short-term Data Log Function

Keypad	Version [*]
LCD Keypad (Model: JVOP-KPLCA04xxx)	REV: H or later
Bluetooth LCD Keypad (Model: JVOP-KPLCC04xxx)	REV: H or later

*1 Refer to “REV” on the keypad nameplate for the keypad version.

Change the LCD keypad screen from the main menu to the Diagnostic Tools screen and select the data log function. Set the number of the monitor to record and the sampling time, then start to record the data log.

Table 12.84 Setting Parameters for Data Log Items

No.	Name	Default	Data Log Monitors
<i>o5-03</i>	Log Monitor Data 1	101	<i>UI-01 [Frequency Reference]</i>
<i>o5-04</i>	Log Monitor Data 2	102	<i>UI-02 [Output Frequency]</i>
<i>o5-05</i>	Log Monitor Data 3	103	<i>UI-03 [Output Current]</i>
<i>o5-06</i>	Log Monitor Data 4	107	<i>UI-07 [DC Bus Voltage]</i>
<i>o5-07</i>	Log Monitor Data 5	108	<i>UI-08 [Output Power]</i>
<i>o5-08</i>	Log Monitor Data 6	000	Not selected
<i>o5-09</i>	Log Monitor Data 7	000	Not selected
<i>o5-10</i>	Log Monitor Data 8	000	Not selected
<i>o5-11</i>	Log Monitor Data 9	000	Not selected
<i>o5-12</i>	Log Monitor Data 10	000	Not selected

Note:

- *o5-xx* is only available when you use an LCD keypad.
- Do not de-energize the drive or disconnect the keypad from the drive during log transfer communication. A loss of connection can cause the log function to fail after you restore power or connect the keypad.
- You can use a microSDHC card that has a maximum of 32 GB capacity.
- For a short-term data log, the drive enables parameters *o5-03 [Log Monitor Data 1]* to *o5-06 [Log Monitor Data 4]*.

■ Log File Specifications

Item	Specification
File storage location	A folder called [Log_File] is created in the root directory of the microSD card.
Filename	<ul style="list-style-type: none"> • Long-term data log: GLOG0xxx.csv • Short-term data log: SLOG0xxx.csv Note: [xxx] identifies a 3-digit decimal number
Maximum number of files	Long-term data log: 999 (GLOG0001.csv to GLOG0999.csv) Short-term data log: 999 (SLOG0001.csv to SLOG0999.csv)
Character code	ASCII code
Line break code	<CR><LF>
Separating character	[,] (Commas)
Header rows	First Row: Drive information including the drive model, software version, control method, and sampling time Second Row: Log data information including the monitor number, number decimal points, and unit code

■ Log File Configuration

The [Log_Files] folder is created in the root directory of the microSD memory card. This is where the log data is stored as CSV files. Log data files are created in this configuration. The number of rows changes when the number of selected monitors change.

First Row	Drive information
Second Row	Log data information
Third Row	Log data 1

12.11 o: Keypad-Related Settings

No.	Item	Number of Characters	Description
15	Encoding data	4	Log Monitor Data 1 to 10 Code Data (Hex.) Bits 0 to 9 show the encoding of log monitor data 1 to 10. A bit value of 1 shows that the data represents a negative value. (Log monitor data 1 to 10 is absolute value data without encoding) Example: When log monitor data 2, 5, and 8 show negative values, bits 1, 4, and 7 have values of 1, and the encoding data = 0010010010 (Bin.) = 0092 (Hex.)
16	Row number	6	Row number (Hex.) in the data log file

■ o5-00: Log Type

No. (Hex.)	Name	Description	Default (Range)
o5-00 (1E81) RUN	Log Type	V/f CL-V/f OLV CLV AOLV OLV/IPM AOLV/IPM CLV/IPM EZOLV Sets the type of data log function. This parameter is only available when you use an LCD keypad.	0 (0, 1)

0 : Long Term Log

Saves data continuously over a long time period.

1 : Short Term Log

Saves data over a set length of time before and after the drive detects a trigger event with a short sampling cycle.

■ o5-01: Log Start/Stop Selection

No. (Hex.)	Name	Description	Default (Range)
o5-01 (1551) RUN	Log Start/Stop Selection	V/f CL-V/f OLV CLV AOLV OLV/IPM AOLV/IPM CLV/IPM EZOLV Sets the data log function. This parameter is only available when using an LCD keypad.	0 (0 - 1)

0 : OFF

Stops the data log.

1 : ON

Starts the data log as specified by the sampling cycle set in o5-02 [Log Sampling Interval].

■ o5-02: Log Sampling Interval

No. (Hex.)	Name	Description	Default (Range)
o5-02 (1552) RUN	Log Sampling Interval	V/f CL-V/f OLV CLV AOLV OLV/IPM AOLV/IPM CLV/IPM EZOLV Sets the data log sampling cycle. This parameter is only available when you use an LCD keypad.	Determined by o5-00 (Determined by o5-00)

Note:

The default setting and setting range change when o5-00 [Normal / Heavy Duty Selection] changes.

- o5-00 = 0 [Long Term Log]
–Default setting: 1000 ms
–Setting range: 100 - 60000 ms
- o5-00 = 1 [Short Term Log]
–Default setting: 10 ms
–Setting range: 1 - 99 ms

■ o5-03: Log Monitor Data 1

No. (Hex.)	Name	Description	Default (Range)
o5-03 (1553) RUN	Log Monitor Data 1	V/f CL-V/f OLV CLV AOLV OLV/IPM AOLV/IPM CLV/IPM EZOLV Sets the data log monitor (Ux-xx). This parameter is only available when you use an LCD keypad.	101 (000, 101 - 9999)

Note:

- Set the x-xx part of the Ux-xx [Monitor]. For example, set o5-03 = 101 to monitor U1-01 [Frequency Reference].
When the x part of Ux is a letter, replace the letter (hexadecimal number) with a decimal number. For example, set o5-03 = 1301 to monitor Ud-01.
- When it is not necessary to set a data log monitor, set this parameter to 000.

■ o5-04: Log Monitor Data 2

No. (Hex.)	Name	Description	Default (Range)
o5-04 (1554) RUN	Log Monitor Data 2	V/f CL-V/f OLV CLV AOLV OLV/PM AOLV/PM CLV/PM EZOLV Sets the data log monitor (<i>Ux-xx</i>). This parameter is only available when you use an LCD keypad.	102 (000, 101 - 9999)

Note:

- Set the *x-xx* part of the *Ux-xx* [Monitor]. For example, set *o5-04 = 102* to monitor *U1-02* [Output Frequency]. When the *x* part of *Ux* is a letter, replace the letter (hexadecimal number) with a decimal number. For example, set *o5-04 = 1301* to monitor *Ud-01*.
- When it is not necessary to set a data log monitor, set this parameter to *000*.

■ o5-05: Log Monitor Data 3

No. (Hex.)	Name	Description	Default (Range)
o5-05 (1555) RUN	Log Monitor Data 3	V/f CL-V/f OLV CLV AOLV OLV/PM AOLV/PM CLV/PM EZOLV Sets the data log monitor (<i>Ux-xx</i>). This parameter is only available when you use an LCD keypad.	103 (000, 101 - 9999)

Note:

- Set the *x-xx* part of the *Ux-xx* [Monitor]. For example, set *o5-05 = 103* to monitor *U1-03* [Output Current]. When the *x* part of *Ux* is a letter, replace the letter (hexadecimal number) with a decimal number. For example, set *o5-05 = 1301* to monitor *Ud-01*.
- When it is not necessary to set a data log monitor, set this parameter to *000*.

■ o5-06: Log Monitor Data 4

No. (Hex.)	Name	Description	Default (Range)
o5-06 (1556) RUN	Log Monitor Data 4	V/f CL-V/f OLV CLV AOLV OLV/PM AOLV/PM CLV/PM EZOLV Sets the data log monitor (<i>Ux-xx</i>). This parameter is only available when you use an LCD keypad.	107 (000, 101 - 9999)

Note:

- Set the *x-xx* part of the *Ux-xx* [Monitor]. For example, set *o5-06 = 107* to monitor *U1-07* [Output Current]. When the *x* part of *Ux* is a letter, replace the letter (hexadecimal number) with a decimal number. For example, set *o5-06 = 1301* to monitor *Ud-01*.
- When it is not necessary to set a data log monitor, set this parameter to *000*.

■ o5-07: Log Monitor Data 5

No. (Hex.)	Name	Description	Default (Range)
o5-07 (1557) RUN	Log Monitor Data 5	V/f CL-V/f OLV CLV AOLV OLV/PM AOLV/PM CLV/PM EZOLV Sets the data log monitor (<i>Ux-xx</i>). This parameter is only available when you use an LCD keypad.	108 (000, 101 - 9999)

Note:

- Set the *x-xx* part of the *Ux-xx* [Monitor]. For example, set *o5-07 = 108* to monitor *U1-08* [Output Current]. When the *x* part of *Ux* is a letter, replace the letter (hexadecimal number) with a decimal number. For example, set *o5-07 = 1301* to monitor *Ud-01*.
- When it is not necessary to set a data log monitor, set this parameter to *000*.

■ o5-08: Log Monitor Data 6

No. (Hex.)	Name	Description	Default (Range)
o5-08 (1558) RUN	Log Monitor Data 6	V/f CL-V/f OLV CLV AOLV OLV/PM AOLV/PM CLV/PM EZOLV Sets the data log monitor (<i>Ux-xx</i>). This parameter is only available when you use an LCD keypad.	000 (000, 101 - 9999)

Note:

- Set the *x-xx* part of the *Ux-xx* [Monitor]. For example, set *o5-08 = 101* to monitor *U1-01* [Frequency Reference]. When the *x* part of *Ux* is a letter, replace the letter (hexadecimal number) with a decimal number. For example, set *o5-08 = 1301* to monitor *Ud-01*.
- When it is not necessary to set a data log monitor, set *o5-08 = 000*.

■ o5-09: Log Monitor Data 7

No. (Hex.)	Name	Description	Default (Range)
o5-09 (1559) RUN	Log Monitor Data 7	V/f CL-V/f OLV CLV AOLV OLV/PM AOLV/PM CLV/PM EZOLV Sets the data log monitor (<i>Ux-xx</i>). This parameter is only available when you use an LCD keypad.	000 (000, 101 - 9999)

Note:

- Set the *x-xx* part of the *Ux-xx* [Monitor]. For example, set *o5-09 = 101* to monitor *U1-01* [Frequency Reference]. When the *x* part of *Ux* is a letter, replace the letter (hexadecimal number) with a decimal number. For example, set *o5-09 = 1301* to monitor *Ud-01*.
- When it is not necessary to set a data log monitor, set this parameter to *000*.

■ o5-10: Log Monitor Data 8

No. (Hex.)	Name	Description	Default (Range)
o5-10 (155A) RUN	Log Monitor Data 8	V/f CL-V/f OLV CLV AOLV OLV/PM AOLV/PM CLV/PM EZOLV Sets the data log monitor (<i>Ux-xx</i>). This parameter is only available when you use an LCD keypad.	000 (000, 101 - 9999)

Note:

- Set the *x-xx* part of the *Ux-xx* [Monitor]. For example, set *o5-10 = 101* to monitor *U1-01* [Frequency Reference]. When the *x* part of *Ux* is a letter, replace the letter (hexadecimal number) with a decimal number. For example, set *o5-10 = 1301* to monitor *Ud-01*.
- When it is not necessary to set a data log monitor, set this parameter to *000*.

■ o5-11: Log Monitor Data 9

No. (Hex.)	Name	Description	Default (Range)
o5-11 (155B) RUN	Log Monitor Data 9	V/f CL-V/f OLV CLV AOLV OLV/PM AOLV/PM CLV/PM EZOLV Sets the data log monitor (<i>Ux-xx</i>). This parameter is only available when you use an LCD keypad.	000 (000, 101 - 9999)

Note:

- Set the *x-xx* part of the *Ux-xx* [Monitor]. For example, set *o5-11 = 101* to monitor *U1-01* [Frequency Reference]. When the *x* part of *Ux* is a letter, replace the letter (hexadecimal number) with a decimal number. For example, set *o5-11 = 1301* to monitor *Ud-01*.
- When it is not necessary to set a data log monitor, set this parameter to *000*.

■ o5-12: Log Monitor Data 10

No. (Hex.)	Name	Description	Default (Range)
o5-12 (155C) RUN	Log Monitor Data 10	V/f CL-V/f OLV CLV AOLV OLV/PM AOLV/PM CLV/PM EZOLV Sets the data log monitor (<i>Ux-xx</i>). This parameter is only available when you use an LCD keypad.	000 (000, 101 - 9999)

Note:

- Set the *x-xx* part of the *Ux-xx* [Monitor]. For example, set *o5-12 = 101* to monitor *U1-01* [Frequency Reference]. When the *x* part of *Ux* is a letter, replace the letter (hexadecimal number) with a decimal number. For example, set *o5-12 = 1301* to monitor *Ud-01*.
- When it is not necessary to set a data log monitor, set this parameter to *000*.

■ o5-15: Trigger Type Selection

No. (Hex.)	Name	Description	Default (Range)
o5-15 (1E82) RUN	Trigger Type Selection	V/f CL-V/f OLV CLV AOLV OLV/PM AOLV/PM CLV/PM EZOLV Sets the type of trigger for the short-term data log. This parameter is only available when you use an LCD keypad.	0 (0, 1)

0 : Digital Trigger

A digital signal inside the drive will act as the trigger.

1 : Analog Trigger

An analog signal inside the drive will act as the trigger.

Note:

There are no detection width and detection time settings for the analog trigger in the data log function. If variations in the analog signal are a problem, set $o5-15 = 0$ and $o5-16 = 66, 67$ [Digital Trigger Object = Comparator 1, 2]. Use $H2-20$ [Comparator 1 Monitor Selection] to $H2-32$ [Comparator 1 Filter Time] to set the conditions for the comparator function.

o5-16: Digital Trigger Object

No. (Hex.)	Name	Description	Default (Range)
o5-16 (1E83) RUN	Digital Trigger Object	V/f CL-V/f OLV CLV AOLV OLV/PM AOLV/PM CLV/PM EZOLV Sets the function for the digital trigger target from the setting values for multi-function digital outputs. This parameter is only available when you use an LCD keypad.	E (0 - FF)

o5-17: Analog Trigger Object

No. (Hex.)	Name	Description	Default (Range)
o5-17 (1E84) RUN	Analog Trigger Object	V/f CL-V/f OLV CLV AOLV OLV/PM AOLV/PM CLV/PM EZOLV Sets the monitor for the analog trigger target. This parameter is only available when you use an LCD keypad.	102 (0 - 9999)

Note:

- Set the $x-xx$ part of the $Ux-xx$ [Monitor]. For example, set $o5-17 = 101$ to monitor $U1-01$ [Frequency Reference]. When the x part of Ux is a letter, replace the letter (hexadecimal number) with a decimal number. For example, set $o5-17 = 1301$ to monitor $Ud-01$.
- When it is not necessary to set a data log monitor, set this parameter to 000 .

o5-18: Analog Trigger Level

No. (Hex.)	Name	Description	Default (Range)
o5-18 (1E85) RUN	Analog Trigger Level	V/f CL-V/f OLV CLV AOLV OLV/PM AOLV/PM CLV/PM EZOLV Sets the level to compare with the analog trigger target. This parameter is only available when you use an LCD keypad.	0.0% (-999.9% - +999.9%)

o5-19: Trigger Condition

No. (Hex.)	Name	Description	Default (Range)
o5-19 (1E86) RUN	Trigger Condition	V/f CL-V/f OLV CLV AOLV OLV/PM AOLV/PM CLV/PM EZOLV Sets the condition with which to detect the trigger. This parameter is only available when you use an LCD keypad.	0 (0, 1)

0 : Rising Edge

- Digital trigger: The drive detects the trigger when the digital trigger target switches from OFF to ON.
- Analog trigger: The drive detects the trigger when the analog trigger target changes from “less than” to “equal or more than” the trigger level set in $o5-18$ [Analog Trigger Level].

1 : Falling Edge

- Digital trigger: The drive detects the trigger when the digital trigger target switches from ON to OFF
- Analog trigger: The drive detects the trigger when the analog trigger target changes from “equal to or more than” to “less than” the trigger level set in $o5-18$ [Analog Trigger Level].

o5-20: Pre-Trigger Setting

No. (Hex.)	Name	Description	Default (Range)
o5-20 (1E87) RUN	Pre-Trigger Setting	V/f CL-V/f OLV CLV AOLV OLV/PM AOLV/PM CLV/PM EZOLV Sets the percentage of data to save before the drive detects the trigger for the short-term data log. This parameter is only available when you use an LCD keypad.	90% (0% - 100%)

■ o5-21: Trend Log Sampling Time Selection

No. (Hex.)	Name	Description	Default (Range)
o5-21 (1E88) RUN	Trend Log Sampling Time Selection	<div style="display: flex; justify-content: space-between; font-size: small;"> V/f CL-V/f OLV CLV AOLV OLV/PM AOLV/PM CLV/PM EZOLV </div> <p>Sets the sampling cycle for the trend log to save data before the drive detects the trigger. The trend log works at the same time as the short-term data log. This parameter is only available when you use an LCD keypad.</p>	0 (0 - 4)

0 : Trend Log Disabled

The drive does not save the trend log.

1 : 0.1 s (About 1 hour)

Saves a trend log with a sampling cycle of 0.1 s. The drive saves a maximum of approximately one hour of data before it detects the trigger.

2 : 1 s (About 10 hours)

Saves a trend log with a sampling cycle of 1 s. The drive saves a maximum of approximately 10 hours of data before it detects the trigger.

3 : 10 s (About 100 hours)

Saves a trend log with a sampling cycle of 10 s. The drive saves a maximum of approximately 100 hours of data before it detects the trigger.

4 : 60 s (About 600 hours)

Saves a trend log with a sampling cycle of 60 s. The drive saves a maximum of approximately 600 hours of data before it detects the trigger.









12.12 T: Auto-Tuning

Numbers identifying the *T* parameters are displayed when an LED keypad is used. The names of the parameters are displayed on the LCD screen of the LCD keypad. Set the following.

- Induction Motor Auto-Tuning
- PM Motor Auto-Tuning
- ASR and Inertia Tuning

◆ T0: Tuning Mode Selection

■ T0-00: Tuning Mode Selection

No. (Hex.)	Name	Description	Default (Range)
T0-00 (1197)	Tuning Mode Selection	         Sets the type of Auto-Tuning.	0 (0, 1)

When you use an LED keypad to do Control Tuning, set the tuning mode in this order:

1. Set *T0-00* = 1.
2. Set *T3-00* [*Control Loop Tuning Selection*] to set the tuning mode.

Note:

The available tuning modes are different for different control methods.

0 : Motor Parameter Tuning

1 : Control Tuning









◆ T1: Induction Motor Auto-Tuning

T1 parameters set the Auto-Tuning input data for induction motor tuning.

Note:

- The base frequency of drive dedicated motors and special motors for use with vector control may be lower than the base frequency of general-purpose motors, which is 50 Hz or 60 Hz. In such cases, this lower frequency is used as the value for *E1-06* [*Base Frequency*] and *E1-04* [*Maximum Output Frequency*] after Auto-Tuning completes. If the maximum output frequency is too low and causes problems, change the setting of *E1-04* after Auto-Tuning completes.
- The following induction motor parameters are set automatically.
 - E1-xx* [*V/f Pattern for Motor 1*]
 - E2-xx* [*Motor Parameters*]
 - E3-xx* [*V/f Pattern for Motor 2*]
 - E4-xx* [*Motor 2 Parameters*]
 - F1-xx* [*Encoder Options*] (only with Closed Loop Vector Control)

■ T1-00: Motor 1/Motor 2 Selection

No. (Hex.)	Name	Description	Default (Range)
T1-00 (0700)	Motor 1/Motor 2 Selection	         Sets which motor to tune when motor 1/2 switching is enabled.	1 (1, 2)

Note:

This parameter is available when *H1-xx* = 16 [*Motor 2 Selection*]. The keypad will not show this parameter when *H1-xx* ≠ 16.

1 : Motor 1 (sets E1-xx, E2-xx)

Auto-Tuning automatically sets parameters *E1-xx* and *E2-xx* for motor 1.

2 : Motor 2 (sets E3-xx, E4-xx)

Auto-Tuning automatically sets parameters *E3-xx* and *E4-xx* for motor 2. Make sure that you connect motor 2 to the drive for Auto-Tuning.

■ T1-01: Auto-Tuning Mode Selection

No. (Hex.)	Name	Description	Default (Range)
T1-01 (0701)	Auto-Tuning Mode Selection	<input type="radio"/> V/f <input type="radio"/> CL-V/f <input type="radio"/> OLV <input type="radio"/> CLV <input type="radio"/> AOLV <input type="radio"/> OLV/PM <input type="radio"/> AOLV/PM <input type="radio"/> CLV/PM <input type="radio"/> EZOLV	Determined by A1-02 (Determined by A1-02)

0 : Rotational Auto-Tuning

1 : Stationary Auto-Tuning 1

2 : Stationary Line-Line Resistance

■ T1-02: Motor Rated Power

No. (Hex.)	Name	Description	Default (Range)
T1-02 (0702)	Motor Rated Power	<input type="radio"/> V/f <input type="radio"/> CL-V/f <input type="radio"/> OLV <input type="radio"/> CLV <input type="radio"/> AOLV <input type="radio"/> OLV/PM <input type="radio"/> AOLV/PM <input type="radio"/> CLV/PM <input type="radio"/> EZOLV	Determined by o2-04, C6-01 (0.00 - 1000.0)

Note:

On drive models 2xxx, and 4002 to 4675, the setting unit is 0.01 kW. The setting range is 0.00 kW to 650.00 kW (0.00 HP to 650.00 HP).

On drive models 4810 to 4H12, the setting unit is 0.1 kW. The setting range is 0.0 kW to 1000.0 kW (0.0 HP to 1340.5 HP).

■ T1-03: Motor Rated Voltage

No. (Hex.)	Name	Description	Default (Range)
T1-03 (0703)	Motor Rated Voltage	<input type="radio"/> V/f <input type="radio"/> CL-V/f <input type="radio"/> OLV <input type="radio"/> CLV <input type="radio"/> AOLV <input type="radio"/> OLV/PM <input type="radio"/> AOLV/PM <input type="radio"/> CLV/PM <input type="radio"/> EZOLV	Determined by o2-04, C6-01 (200 V Class: 0.0 - 255.5 V, 400 V Class: 0.0 - 511.0 V)

If you do Auto-Tuning on a drive-dedicated motor or a specialized motor for vector control, the voltage or frequency can be lower than that of a general-purpose motor. Always compare the data from the nameplate or test report with the Auto-Tuning results and check for differences. Enter the voltage necessary to operate the motor in no-load conditions at rated speed for better control precision around rated speed. If the motor test report or the motor nameplate is not available, enter approximately 90% of the motor rated voltage.

If the drive input power supply voltage is low, enter approximately 90% of the input voltage. When the input power supply voltage is low, the current will increase. Make sure that the main power supply capacity is correct and use a molded-case circuit breaker for the drive.

■ T1-04: Motor Rated Current

No. (Hex.)	Name	Description	Default (Range)
T1-04 (0704)	Motor Rated Current	<input type="radio"/> V/f <input type="radio"/> CL-V/f <input type="radio"/> OLV <input type="radio"/> CLV <input type="radio"/> AOLV <input type="radio"/> OLV/PM <input type="radio"/> AOLV/PM <input type="radio"/> CLV/PM <input type="radio"/> EZOLV	Determined by o2-04 (10% to 200% of the drive rated current)

Set the motor rated current between 50% and 100% of the drive rated current for the best performance. Enter the current at the motor base speed.

■ T1-05: Motor Base Frequency

No. (Hex.)	Name	Description	Default (Range)
T1-05 (0705)	Motor Base Frequency	<input type="radio"/> V/f <input type="radio"/> CL-V/f <input type="radio"/> OLV <input type="radio"/> CLV <input type="radio"/> AOLV <input type="radio"/> OLV/PM <input type="radio"/> AOLV/PM <input type="radio"/> CLV/PM <input type="radio"/> EZOLV	50.0 Hz (0.0 - 590.0 Hz)

When Auto-Tuning is carried out, the value of T1-05 is set to E1-04 [Maximum Output Frequency]. If T1-05 < 40 Hz, E1-04 = 40 Hz. If you operate the drive at a speed that is higher than the base frequency, or if you operate in the field weakening range, set E1-04 (E3-04 for motor 2) to the maximum output frequency after you complete Auto-Tuning.

■ T1-06: Number of Motor Poles

No. (Hex.)	Name	Description	Default (Range)
T1-06 (0706)	Number of Motor Poles	<input type="checkbox"/> V/f <input type="checkbox"/> CL-V/f <input type="checkbox"/> OLV <input checked="" type="checkbox"/> CLV <input type="checkbox"/> AOLV <input type="checkbox"/> OLV/PM <input type="checkbox"/> AOLV/PM <input type="checkbox"/> CLV/PM <input type="checkbox"/> EZOLV Sets the number of motor poles.	4 (2 to 120)

■ T1-07: Motor Base Speed

No. (Hex.)	Name	Description	Default (Range)
T1-07 (0707)	Motor Base Speed	<input type="checkbox"/> V/f <input type="checkbox"/> CL-V/f <input type="checkbox"/> OLV <input checked="" type="checkbox"/> CLV <input type="checkbox"/> AOLV <input type="checkbox"/> OLV/PM <input type="checkbox"/> AOLV/PM <input type="checkbox"/> CLV/PM <input type="checkbox"/> EZOLV Sets the motor base speed for Auto-Tuning (min^{-1} (r/min)).	1450 min^{-1} (r/min) (0 - 35400 min^{-1} (r/min))

■ T1-08: Encoder Pulse Count (PPR)

No. (Hex.)	Name	Description	Default (Range)
T1-08 (0708)	Encoder Pulse Count (PPR)	<input type="checkbox"/> V/f <input type="checkbox"/> CL-V/f <input type="checkbox"/> OLV <input checked="" type="checkbox"/> CLV <input type="checkbox"/> AOLV <input type="checkbox"/> OLV/PM <input type="checkbox"/> AOLV/PM <input type="checkbox"/> CLV/PM <input type="checkbox"/> EZOLV Sets the number of PG (pulse generator, encoder) pulses.	1024 ppr (0 - 60,000 ppr)

Set the actual number of pulses for one full motor rotation.

■ T1-09: Motor No-Load Current

No. (Hex.)	Name	Description	Default (Range)
T1-09 (0709)	Motor No-Load Current	<input type="checkbox"/> V/f <input type="checkbox"/> CL-V/f <input checked="" type="checkbox"/> OLV <input checked="" type="checkbox"/> CLV <input type="checkbox"/> AOLV <input type="checkbox"/> OLV/PM <input type="checkbox"/> AOLV/PM <input type="checkbox"/> CLV/PM <input type="checkbox"/> EZOLV Sets the no-load current of the motor.	- (0 A - T1-04; max. of 2999.9)

Note:

The display units are different for different models:

- Models 2004 - 2042, 4002 - 4023: 0.01 A
- Models 2056 - 2415, 4031 - 4H12: 0.1 A

The value shown is the no-load current that the drive automatically calculates from the values set in T1-02 [Motor Rated Power] and T1-04 [Motor Rated Current]. Set the no-load current shown on the motor test report. If the motor test report is not available, do not change this parameter.

■ T1-10: Motor Rated Slip Frequency

No. (Hex.)	Name	Description	Default (Range)
T1-10 (070A)	Motor Rated Slip Frequency	<input type="checkbox"/> V/f <input type="checkbox"/> CL-V/f <input type="checkbox"/> OLV <input checked="" type="checkbox"/> CLV <input type="checkbox"/> AOLV <input type="checkbox"/> OLV/PM <input type="checkbox"/> AOLV/PM <input type="checkbox"/> CLV/PM <input type="checkbox"/> EZOLV Sets motor rated slip.	- (0.000 - 20.000 Hz)

Shows 0.000 Hz as the default value. Set the rated slip shown on the motor test report. If the motor test report is not available, do not change this parameter.

■ T1-11: Motor Iron Loss

No. (Hex.)	Name	Description	Default (Range)
T1-11 (070B)	Motor Iron Loss	<input type="checkbox"/> V/f <input type="checkbox"/> CL-V/f <input type="checkbox"/> OLV <input checked="" type="checkbox"/> CLV <input type="checkbox"/> AOLV <input type="checkbox"/> OLV/PM <input type="checkbox"/> AOLV/PM <input type="checkbox"/> CLV/PM <input type="checkbox"/> EZOLV Sets the iron loss to calculate the energy-saving coefficient.	Determined by E2-10 or E4-10 (0 - 65535 W)

Note:

The default setting is different for different motor codes and motor parameter settings.

The value shown is E2-10 [Motor Iron Loss] or E4-10 [Motor 2 Iron Loss] for the motor output set in T1-02 [Motor Rated Power]. If the motor test report is available, enter the motor iron loss value to T1-11.

■ T1-12: Test Mode Selection

No. (Hex.)	Name	Description	Default (Range)
T1-12 (0BDB)	Test Mode Selection	<div style="display: flex; justify-content: space-between; font-size: 0.8em;"> V/f CL-V/f OLV CLV AOLV OLV/PM AOLV/PM CLV/PM EZOLV </div> <p>Sets the function to enable Test Mode after Stationary Auto-Tuning. When you can operate the motor with a light load attached after Stationary Auto-Tuning is complete, enable this parameter.</p>	0 (0, 1)

0 : No

1 : Yes

After Auto-Tuning, the drive automatically sets *E2-02 [Motor Rated Slip]* and *E2-03 [Motor No-Load Current]* when you operate the motor for the first time in Drive Mode.

Note:

After Auto-Tuning is complete and you set the drive to Drive Mode, operate the motor in these conditions:

- Make sure that you connect all wiring between the drive and motor
- Make sure that a mechanical brake on the motor shaft is not locked
- Keep the motor-load ratio at 30%
- Hold constant speed for longer than 1 second at a minimum of 30% of the speed set in *E1-06 [Base Frequency]* (the default setting is the same as the maximum frequency).

■ T1-13: No-load voltage

No. (Hex.)	Name	Description	Default (Range)
T1-13 (0BDC)	No-load voltage	<div style="display: flex; justify-content: space-between; font-size: 0.8em;"> V/f CL-V/f OLV CLV AOLV OLV/PM AOLV/PM CLV/PM EZOLV </div> <p>Sets the no-load voltage of the motor. When the no-load voltage at rated speed is available, for example on the motor test report, set the voltage in this parameter. If the no-load voltage is not available, do not change this parameter.</p>	T1-03 × 0.85 (200 V Class: 0.0 - 255.0 V, 400 V Class: 0.0 - 510.0 V)

Note:

To get the same qualities as a Yaskawa 1000-series drive or previous series drive, set this parameter = *T1-03 [Motor Rated Voltage]*.

◆ T2: PM Motor Auto-Tuning

T2 parameters set the Auto-Tuning input data for PM motor tuning.

Note:

The drive automatically sets these PM motor parameters:

- E1-xx [V/f Pattern for Motor 1]
- E5-xx [V/f Pattern for Motor 1]
- F1-xx [Encoder Option Setup]
Only when *A1-02 = 7 [Control Method Selection = PM Closed Loop Vector]*

■ T2-01: PM Auto-Tuning Selection

No. (Hex.)	Name	Description	Default (Range)
T2-01 (0750)	PM Auto-Tuning Selection	<div style="display: flex; justify-content: space-between; font-size: 0.8em;"> V/f CL-V/f OLV CLV AOLV OLV/PM AOLV/PM CLV/PM EZOLV </div> <p>Sets the type of Auto-Tuning for PM motors.</p>	0 (Determined by A1-02)

Note:

Yaskawa recommends Rotational (Ld, Lq, R, back-EMF) for specialized motors. Rotational Auto-Tuning rotates the motor to measure the actual induction voltage constants for more accurate control than Stationary Auto-Tuning.

0 : Manual Entry w/ Motor Data Sheet

1 : Stationary (Ld, Lq, R)

2 : Stationary (R Only)

3 : Z-Pulse Offset (Pole Position)

4 : Rotational (Ld, Lq, R, back-EMF)

5 : High Frequency Injection

■ T2-02: PM Motor Code Selection

No. (Hex.)	Name	Description	Default (Range)
T2-02 (0751)	PM Motor Code Selection	<div style="display: flex; justify-content: space-between; font-size: 0.8em;"> V/f CL-V/f OLV CLV AOLV OLV/PM AOLV/PM CLV/PM EZOLV </div> Enter the PM motor code as specified by the rotation speed and motor output.	Determined by A1-02 and o2-04 (0000 - FFFF)

Enter the motor code in this parameter to automatically set parameters *T2-03 to T2-14*. When you are operating a specialized motor or a non-Yaskawa motor, set this parameter to *FFFF* and enter the data from the motor nameplate or the motor test report.

You can only enter the permitted PM motor codes. Different drive control methods will accept different PM motor codes.

■ T2-03: PM Motor Type

No. (Hex.)	Name	Description	Default (Range)
T2-03 (0752)	PM Motor Type	<div style="display: flex; justify-content: space-between; font-size: 0.8em;"> V/f CL-V/f OLV CLV AOLV OLV/PM AOLV/PM CLV/PM EZOLV </div> Sets the type of PM motor the drive will operate.	1 (0, 1)

0 : IPM motor

IPM motors have magnets in the rotor, and $L_d \neq L_q$.

1 : SPM motor

SPM motors have magnets attached to the surface of the rotor with adhesive material, and $L_d = L_q$.

■ T2-04: PM Motor Rated Power

No. (Hex.)	Name	Description	Default (Range)
T2-04 (0730)	PM Motor Rated Power	<div style="display: flex; justify-content: space-between; font-size: 0.8em;"> V/f CL-V/f OLV CLV AOLV OLV/PM AOLV/PM CLV/PM EZOLV </div> Sets the PM motor rated output in the units from o1-58 [Motor Power Unit Selection].	Determined by o2-04, C6-01 (0.00 - 1000.0)

Note:

On drive models 2xxx, and 4002 to 4675, the setting unit is 0.01 kW. The setting range is 0.00 kW to 650.00 kW (0.00 HP to 650.00 HP).

On drive models 4810 to 4H12, the setting unit is 0.1 kW. The setting range is 0.0 kW to 1000.0 kW (0.0 HP to 1340.5 HP).

■ T2-05: PM Motor Rated Voltage

No. (Hex.)	Name	Description	Default (Range)
T2-05 (0732)	PM Motor Rated Voltage	<div style="display: flex; justify-content: space-between; font-size: 0.8em;"> V/f CL-V/f OLV CLV AOLV OLV/PM AOLV/PM CLV/PM EZOLV </div> Sets the rated voltage (V) of the motor.	200 V Class: 200.0 V, 400 V Class: 400.0 V (200 V Class: 0.0 - 255.0 V, 400 V Class: 0.0 - 510.0 V)

■ T2-06: PM Motor Rated Current

No. (Hex.)	Name	Description	Default (Range)
T2-06 (0733)	PM Motor Rated Current	<div style="display: flex; justify-content: space-between; font-size: 0.8em;"> V/f CL-V/f OLV CLV AOLV OLV/PM AOLV/PM CLV/PM EZOLV </div> Sets the rated current (A) of the motor.	Determined by o2-04 (10% to 200% of the drive rated current)

■ T2-07: PM Motor Base Frequency

No. (Hex.)	Name	Description	Default (Range)
T2-07 (0753)	PM Motor Base Frequency	<div style="display: flex; justify-content: space-between; font-size: 0.8em;"> V/f CL-V/f OLV CLV AOLV OLV/PM AOLV/PM CLV/PM EZOLV </div> Sets the base frequency (Hz) of the motor.	87.5 Hz (0.0 - 590.0 Hz)

■ T2-08: Number of PM Motor Poles

No. (Hex.)	Name	Description	Default (Range)
T2-08 (0734)	Number of PM Motor Poles	<input type="checkbox"/> V/f <input type="checkbox"/> CL-V/f <input type="checkbox"/> OLV <input type="checkbox"/> CLV <input type="checkbox"/> AOLV <input checked="" type="checkbox"/> OLV/PM <input checked="" type="checkbox"/> AOLV/PM <input checked="" type="checkbox"/> CLV/PM <input type="checkbox"/> EZOLV Sets the number of motor poles.	6 (2 - 120)

■ T2-09: PM Motor Base Speed

No. (Hex.)	Name	Description	Default (Range)
T2-09 (0731)	PM Motor Base Speed	<input type="checkbox"/> V/f <input type="checkbox"/> CL-V/f <input type="checkbox"/> OLV <input type="checkbox"/> CLV <input type="checkbox"/> AOLV <input checked="" type="checkbox"/> OLV/PM <input checked="" type="checkbox"/> AOLV/PM <input checked="" type="checkbox"/> CLV/PM <input type="checkbox"/> EZOLV Sets the motor base speed (min ⁻¹ (r/min)).	1750 min ⁻¹ (r/min) (0 - 34500 min ⁻¹ (r/min))

■ T2-10: PM Motor Stator Resistance

No. (Hex.)	Name	Description	Default (Range)
T2-10 (0754)	PM Motor Stator Resistance	<input type="checkbox"/> V/f <input type="checkbox"/> CL-V/f <input type="checkbox"/> OLV <input type="checkbox"/> CLV <input type="checkbox"/> AOLV <input checked="" type="checkbox"/> OLV/PM <input checked="" type="checkbox"/> AOLV/PM <input checked="" type="checkbox"/> CLV/PM <input type="checkbox"/> EZOLV Sets the stator resistance for each motor phase.	Determined by T2-02 (0.000 - 65.000 Ω)

Note:

- This parameter does not set line-to-line resistance.
- On drive models 4810 to 4H12, the unit is mΩ, and the setting range is 0.000 mΩ to 65.000 mΩ.

■ T2-11: PM Motor d-Axis Inductance

No. (Hex.)	Name	Description	Default (Range)
T2-11 (0735)	PM Motor d-Axis Inductance	<input type="checkbox"/> V/f <input type="checkbox"/> CL-V/f <input type="checkbox"/> OLV <input type="checkbox"/> CLV <input type="checkbox"/> AOLV <input checked="" type="checkbox"/> OLV/PM <input checked="" type="checkbox"/> AOLV/PM <input checked="" type="checkbox"/> CLV/PM <input type="checkbox"/> EZOLV Sets the d-axis inductance of the motor on a per phase basis.	Determined by T2-02 (0.00 - 600.00 mH)

■ T2-12: PM Motor q-Axis Inductance

No. (Hex.)	Name	Description	Default (Range)
T2-12 (0736)	PM Motor q-Axis Inductance	<input type="checkbox"/> V/f <input type="checkbox"/> CL-V/f <input type="checkbox"/> OLV <input type="checkbox"/> CLV <input type="checkbox"/> AOLV <input checked="" type="checkbox"/> OLV/PM <input checked="" type="checkbox"/> AOLV/PM <input checked="" type="checkbox"/> CLV/PM <input type="checkbox"/> EZOLV Sets the q-Axis inductance of the motor on a per phase basis.	Determined by T2-02 (0.00 - 600.00 mH)

■ T2-13: Back-EMF Units Selection

No. (Hex.)	Name	Description	Default (Range)
T2-13 (0755)	Back-EMF Units Selection	<input type="checkbox"/> V/f <input type="checkbox"/> CL-V/f <input type="checkbox"/> OLV <input type="checkbox"/> CLV <input type="checkbox"/> AOLV <input checked="" type="checkbox"/> OLV/PM <input checked="" type="checkbox"/> AOLV/PM <input checked="" type="checkbox"/> CLV/PM <input type="checkbox"/> EZOLV Sets the units that the drive uses to set the induced voltage constant.	1 (0, 1)

0 : mV/(rev/min)

1 : mV/(rad/s)

Note:

- When $T2-13 = 0$, the drive will use $E5-24$ [PM Back-EMF L-L Vrms (mV/rpm)] and will automatically set $E5-09$ [PM Back-EMF Vpeak (mV/(rad/s))] = 0.0.
- When $T2-13 = 1$, the drive will use $E5-09$ and will automatically set $E5-24 = 0.0$.

■ T2-14: Back-EMF Voltage Constant (Ke)

No. (Hex.)	Name	Description	Default (Range)
T2-14 (0737)	Back-EMF Voltage Constant (Ke)	<input type="checkbox"/> V/f <input type="checkbox"/> CL-V/f <input type="checkbox"/> OLV <input type="checkbox"/> CLV <input type="checkbox"/> AOLV <input checked="" type="checkbox"/> OLV/PM <input checked="" type="checkbox"/> AOLV/PM <input checked="" type="checkbox"/> CLV/PM <input type="checkbox"/> EZOLV Sets the motor induced voltage constant (Ke).	Determined by T2-13 (0.0 - 2000.0)

■ T2-15: Pull-In Current Level

No. (Hex.)	Name	Description	Default (Range)
T2-15 (0756)	Pull-In Current Level	<input type="checkbox"/> V/f <input type="checkbox"/> CL-V/f <input type="checkbox"/> OLV <input type="checkbox"/> CLV <input type="checkbox"/> AOLV <input checked="" type="checkbox"/> OLV/PM <input checked="" type="checkbox"/> AOLV/PM <input checked="" type="checkbox"/> CLV/PM <input type="checkbox"/> EZOLV Sets the level of the pull-in current as a percentage of $E5-03$ [PM Motor Rated Current (FLA)]. Usually it is not necessary to change this setting.	30% (0 - 120%)

If the load inertia is high, increase the setting value.

■ T2-16: Encoder Pulse Count (PPR)

No. (Hex.)	Name	Description	Default (Range)
T2-16 (0738)	Encoder Pulse Count (PPR)	V/f CL-V/f OLV CLV AOLV OLV/PM AOLV/PM CLV/PM EZOLV Sets the number of PG (pulse generator, encoder) pulses.	1024 ppr (1 - 15000 ppr)

Set the actual number of pulses for one full motor rotation.

■ T2-17: Encoder Z-Pulse Offset

No. (Hex.)	Name	Description	Default (Range)
T2-17 (0757)	Encoder Z-Pulse Offset	V/f CL-V/f OLV CLV AOLV OLV/PM AOLV/PM CLV/PM EZOLV Sets the encoder Z-pulse offset ($\Delta\theta$) (pulse generator, encoder) that is listed on the motor nameplate.	0.0 ° (-180.0 - +180.0°)

If you do not know the quantity of encoder (pulse generator, encoder) Z-pulse offset, or if you replaced the encoder, do Z Pulse Offset Tuning and correct for the offset ($\Delta\theta$) from the Z phase.

◆ T3: ASR and Inertia Tuning

■ T3-00: Control Loop Tuning Selection

No. (Hex.)	Name	Description	Default (Range)
T3-00 (1198)	Control Loop Tuning Selection	V/f CL-V/f OLV CLV AOLV OLV/PM AOLV/PM CLV/PM EZOLV Sets the type of Control Auto-Tuning.	0 (0 - 3)

0 : Inertia Tuning

1 : ASR (Speed Regulator)

2 : Deceleration Rate Tuning

3 : KEB Tuning

Note:

Settings 0 and 1 are available only when $A1-02 = 3, 7$ [Control Method Selection = CLV, CLV/PM].

■ T3-01: Test Signal Frequency

No. (Hex.)	Name	Description	Default (Range)
T3-01 (0760)	Test Signal Frequency	V/f CL-V/f OLV CLV AOLV OLV/PM AOLV/PM CLV/PM EZOLV Sets the frequency of the test signal applied to the motor during Inertia Tuning. Usually it is not necessary to change this setting.	3.0 Hz (0.1 - 20.0 Hz)

If the load inertia is too large and the drive detects a fault after Inertia Tuning, decrease the setting.

■ T3-02: Test Signal Amplitude

No. (Hex.)	Name	Description	Default (Range)
T3-02 (0761)	Test Signal Amplitude	V/f CL-V/f OLV CLV AOLV OLV/PM AOLV/PM CLV/PM EZOLV Sets the amplitude of the test signal applied to the motor during Inertia Tuning. Usually it is not necessary to change this setting.	0.5 rad (0.1 - 10.0 rad)

If the load inertia is too large and the drive detects a fault after Inertia Tuning, decrease the setting. If the drive detects a fault when T3-01 [Test Signal Frequency] is set to a low value, adjust this parameter.

■ T3-03: Motor Inertia

No. (Hex.)	Name	Description	Default (Range)
T3-03 (0762)	Motor Inertia	V/f CL-V/f OLV CLV AOLV OLV/PM AOLV/PM CLV/PM EZOLV Sets the inertia of the motor. This value uses the test signal response to calculate the load inertia.	Determined by o2-04, C6-01, and E5-01 (0.0001 - 600.00 kgm ²)

The default setting is for a Yaskawa standard motor as shown in the motor inertia table. Actual values will be different when you use induction motors or PM motors.

Note:

The display units for the default setting and setting range are different for different models:

- 0.0001 kgm² units (setting range: 0.0001 kgm² to 6.0000 kgm²): 2004 to 2021, 4002 to 4012
- 0.001 kgm² units (setting range: 0.001 kgm² to 60.000 kgm²): 2030 to 2211, 4018 to 4103
- 0.01 kgm² units (setting range: 0.01 kgm² to 600.00 kgm²): 2257 to 2415, 4140 to 4H12

■ **T3-04: System Response Frequency**

No. (Hex.)	Name	Description	Default (Range)
T3-04 (0763)	System Response Frequency	<div style="display: flex; justify-content: space-between; font-size: 0.8em;"> V/f CL-V/f OLV CLV AOLV OLV/PM AOLV/PM CLV/PM EZOLV </div> <p>This parameter uses the load inertia value from the Inertia Tuning process to automatically calculate and set C5-01 [ASR Proportional Gain I].</p>	10.0 Hz (0.1 - 50.0 Hz)

If this input value is too high, it can cause oscillation.

◆ **T4: EZ Tuning**

Use T4 parameters to input the data necessary for motor parameter Auto-Tuning when A1-02 = 8 [Control Method Selection = EZ Vector Control]. These two modes are available:

T4-01 Setting	Operational overview	Items input for tuning	Items tuned
0	Follow the instructions in the setup wizard on the keypad to manually enter the necessary motor parameters.	<ul style="list-style-type: none"> • T4-02 [Motor Type Selection] • T4-03 [Motor Max Revolutions] • T4-04 [Motor Rated Revolutions] • T4-05 [Motor Rated Frequency] [*]/ • T4-06 [Motor Rated Voltage] • T4-07 [Motor Rated Current] • T4-08 [Motor Rated Capacity] • T4-09 [Number of Poles] 	<ul style="list-style-type: none"> • E9-01 [Motor Type Selection] • E9-02 [Maximum Speed] • E9-03 [Rated Speed] • E9-04 [Base Frequency] • E9-05 [Base Voltage] • E9-06 [Motor Rated Current (FLA)] • E9-07 [Motor Rated Power] • E9-08 [Motor Pole Count] • E9-09 [Motor Rated Slip] • E9-10 [Motor Line-to-Line Resistance]
1	Do only line-to-line resistance tuning.	Motor Rated Current	E9-10 [Motor Line-to-Line Resistance]

*1 When you use a PM motor or a synchronous reluctance motor, it is not necessary to enter the rated frequency. The drive will use the rated rotation speed and number of motor poles to automatically calculate the rated frequency.

■ **T4-01: EZ Tuning Mode Selection**

No. (Hex.)	Name	Description	Default (Range)
T4-01 (3130)	EZ Tuning Mode Selection	<div style="display: flex; justify-content: space-between; font-size: 0.8em;"> V/f CL-V/f OLV CLV AOLV OLV/PM AOLV/PM CLV/PM EZOLV </div> <p>Sets the type of Auto-Tuning for EZOLV control.</p>	0 (0, 1)

0 : Motor Parameter Setting

1 : Line-to-Line Resistance

■ **T4-02: Motor Type Selection**

No. (Hex.)	Name	Description	Default (Range)
T4-02 (3131)	Motor Type Selection	<div style="display: flex; justify-content: space-between; font-size: 0.8em;"> V/f CL-V/f OLV CLV AOLV OLV/PM AOLV/PM CLV/PM EZOLV </div> <p>Sets the type of motor.</p>	0 (0, 1, 2)

0 : Induction (IM)

1 : Permanent Magnet (PM)

2 : Synchronous Reluctance (SynRM)

■ **T4-04: Motor Rated Revolutions**

No. (Hex.)	Name	Description	Default (Range)
T4-04 (3133)	Motor Rated Revolutions	<div style="display: flex; justify-content: space-between; font-size: 0.8em;"> V/f CL-V/f OLV CLV AOLV OLV/PM AOLV/PM CLV/PM EZOLV </div> <p>Sets rated rotation speed (min⁻¹) of the motor.</p>	- ((40 Hz to 120 Hz) × 60 × 2/E9-08)

■ T4-05: Motor Rated Frequency

No. (Hex.)	Name	Description	Default (Range)
T4-05 (3134)	Motor Rated Frequency	<div style="display: flex; gap: 5px;"> V/f CL-V/f OLV CLV AOLV OLV/PM AOLV/PM CLV/PM EZOLV </div> Sets the rated frequency (Hz) of the motor.	Determined by E9-01 and o2-04 (40.0 - 120.0 Hz)

Note:

When $T4-02 = 1, 2$ [Motor Type Selection = Permanent Magnet (PM), Synchronous Reluctance (SynRM)], input is not necessary because it assumes: Motor Rated Revolutions/60 × Number of Motor Poles/2.

■ T4-06: Motor Rated Voltage

No. (Hex.)	Name	Description	Default (Range)
T4-06 (3135)	Motor Rated Voltage	<div style="display: flex; gap: 5px;"> V/f CL-V/f OLV CLV AOLV OLV/PM AOLV/PM CLV/PM EZOLV </div> Sets the rated voltage (V) of the motor.	200 V Class: 200.0 V, 400 V Class: 400.0 V (200 V Class: 0.0 - 255.0 V, 400 V Class: 0.0 - 510.0 V)

■ T4-07: Motor Rated Current

No. (Hex.)	Name	Description	Default (Range)
T4-07 (3136)	Motor Rated Current	<div style="display: flex; gap: 5px;"> V/f CL-V/f OLV CLV AOLV OLV/PM AOLV/PM CLV/PM EZOLV </div> Sets the rated current (A) of the motor.	Determined by o2-04, C6-01 (10% to 200% of the drive rated current)

Note:

The value set here becomes the base value for motor protection, the torque limit, and torque control.

■ T4-08: PM Motor Rated Power (kW)

No. (Hex.)	Name	Description	Default (Range)
T4-08 (3137)	PM Motor Rated Power	<div style="display: flex; gap: 5px;"> V/f CL-V/f OLV CLV AOLV OLV/PM AOLV/PM CLV/PM EZOLV </div> Sets the motor rated output in the units from o1-58 [Motor Power Unit Selection].	Determined by E9-10 (0.10 - 1000.0)

Note:

On drive models 2xxx, and 4002 to 4675, the setting unit is 0.01 kW. The setting range is 0.10 kW to 650.00 kW (0.10 HP to 650.00 HP).

On drive models 4810 to 4H12, the setting unit is 0.1 kW. The setting range is 0.1 kW to 1000.0 kW (0.1 HP to 1340.5 HP).

■ T4-09: Number of Poles

No. (Hex.)	Name	Description	Default (Range)
T4-09 (3138)	Number of Poles	<div style="display: flex; gap: 5px;"> V/f CL-V/f OLV CLV AOLV OLV/PM AOLV/PM CLV/PM EZOLV </div> Sets the number of motor poles.	Determined by E9-01 (2 - 120)

Index

Symbols

Numerics

- 24 V power supply
 - Power supply input terminals 107

A

- AC reactor
 - Wiring 133
- Acceleration and deceleration times
 - Switching by external input 731
 - Switching by output frequency 732
 - Switching by Motor 2 Selection commands 732
- Acceleration time
 - Parameter 731
 - Unit of measurement setting 734
- Adjustment of control functionality 217
- AER 371
- AFR
 - Parameter 960
- Alarm 336, 371
- ALM indicator 149, 151
- ALM/ERR
 - LED status 155
- Altitude
 - Derating 475
 - Environment 34
- Ambient humidity 34
- Ambient Temperature Setting 34
 - Derating 474
 - Parameter 474, 951
- Analog gauge
 - Monitors 168
- Analog input
 - Function selection for terminals A1 through A3 884
- Analog Output
 - Gain/Bias Adjustment 896
 - Monitor Parameter Selection 896
 - Signal Level Selection 896
 - Terminal AM Monitor Selection 898
 - Terminal FM Monitor Selection 897
- Application Preset 663
 - Operation 204
- ASR
 - Closed Loop V/f Control adjustment procedure 744
 - Fine tuning 746
 - Parameter 743
 - Vector Control Adjustment Procedure 745
- ASR tuning 210
 - Precautions 213
- Auto-Tuning 206
 - ASR and Inertia Tuning Parameters 1011
 - ASR tuning 210
 - Induction Motor 206
 - Induction Motor Parameters 1005
 - Inertia Tuning 210
 - PM Motor Parameters 1008
 - PM motors 207
 - Precautions 211
 - Precautions to Note before ASR Tuning 213
 - Precautions to Note before Inertia Tuning 213
 - Procedure 184
 - Rotational Auto-Tuning Precautions 212
 - Stationary Auto-Tuning for Line-to-Line Resistance precautions 213
 - Stationary Auto-Tuning Precautions 213
 - Stator resistance Auto-Tuning precautions 213

- Stationary Auto-Tuning Precautions 213
- Stator resistance Auto-Tuning precautions 213
- Auto-Tuning Error 336, 387

B

- Backlight
 - Timing of shut-off 199
- Backup
 - Parameters (drive to keypad) 177
- Backup function 992
- Bar graph
 - Monitors 166
- Base frequency
 - Parameter 784
- Base Frequency
 - Motor 2 Parameters 789
- Base voltage
 - Motor 2 parameters 790
 - Parameter 785
- Basic operation
 - Get started 157
- bAT
 - Fault 342
 - Minor Fault 371
- Battery
 - Disposal 453
 - Replacement 447
 - Specifications 447
- bb 371
- bCE
 - Fault 342
 - Minor Fault 371
- Bi-Directional function 768–769
- boL
 - Fault 342
 - Minor Fault 371
- Braking Resistor
 - Protective function 948
 - Wiring 121
- bUS
 - Detection condition settings 826
 - Detection conditions 823
 - Fault 342
 - Minor Fault 371
 - Operation Selection after Detection 822
- bUSy 372
- C**
- CALL 372
- Capacitor Maintenance Setting 994
- Carrier frequency
 - Derating 470
 - Diminish 954
 - Parameter 752
- CDBR type braking unit
 - Connect multiple units 128
 - Wiring 122
- CE
 - Detection Selection 901
 - Detection Time 901
 - Fault 342
 - Minor Fault 372
 - Operation Selection after Detection 900
- CF 343
- Checklist
 - Test run 224
- Circulation Fan
 - Replacement 410

CoF	343	CyC.....	373
Communication option		CyPo	373
Parameter	816	D	
Control circuit terminal block		Data log.....	193
Replacement.....	442	Data log type	1000
Control circuit terminals		Monitor selection	193, 196
Configuration of terminal block	110	Sampling time.....	194–195
I/O terminals function selection switches	114	Start procedure	191
Terminal functions.....	105	Stop procedure	191
Wire gauge.....	110	Trigger	1002–1003
Wiring.....	104	DC Injection Braking	
Wiring procedure for terminal block.....	111	Parameter	693
Control method		DC reactor	
Selection	660	Wiring.....	133
Cooling Fan		Deceleration time	
Activation Conditions Setting.....	951	Parameter	731
Estimated Lifespan	408	Unit of measurement setting	734
Off Delay Timer	951	Delete	
Replacement.....	410	Delete Backed-up Parameters.....	180
Copy Function Error	336, 392	Derating	
CP1		Altitude.....	475
Fault	343	Ambient Temperature Setting.....	474, 951
Minor Fault	372	Carrier frequency	470
CP2		Enclosure Type.....	474, 953
Fault	343	External Cooling Fin	474, 953
Minor Fault	373	Finless.....	474, 953
CPF00.....	344	Side-by-side	474, 953
CPF01.....	344	dEv	
CPF02.....	344	Detection level	801
CPF03.....	344	Detection time.....	801
CPF06.....	344	Fault	348
CPF07.....	344	Minor Fault	373
CPF08.....	344	Operation Selection after Detection.....	800
CPF10.....	344	dFPS.....	392
CPF11.....	345	DI-A3	
CPF12.....	345	Parameter	807
CPF13.....	345	Diagnosing and Resetting Faults	393
CPF14.....	345	Digital input option	
CPF16.....	345	Parameter	807
CPF17.....	345	Digital output option	
CPF18.....	345	Parameter	814
CPF19.....	345	DIP switch.....	114
CPF20.....	345	Disposal	
CPF21.....	346	Battery.....	453
CPF22.....	346	Drive.....	453
CPF23.....	346	microSD card.....	453
CPF24.....	346	Packing material	453
CPF26.....	346	dnE	373
CPF27.....	346	DO-A3	
CPF28.....	346	Parameter	814
CPF29.....	346	Down 2 command	
CPF30.....	346	Parameter	764, 768
CPF31.....	347	Down command	846–847
CPF32.....	347	Parameter	764, 768
CPF33.....	347	Drive	
CPF34.....	347	Control Circuit Terminal Block Replacement	442
CPF35.....	347	Disposal	453
CPF36.....	347	Exterior and Mounting Dimensions (IP00/UL Open	
CPF37.....	347	Type).....	486
CPF38.....	347	Exterior and Mounting Dimensions (IP20/UL Open	
CPF39.....	347	Type).....	477–485
CPyE	392	Exterior and Mounting Dimensions (IP20/UL Type 1)...	487–494
Crimp ferrule.....	110	Exterior Dimensions Diagram (IP20).....	496–500
CrST.....	373	Initialization	661
CSEr.....	392	Initialize Parameters.....	661
Cumulative Operation TimeSetting	994	Inspection	406
Current Detection Speed Search.....	697		

Long-Term Storage	449
Rating (200 V)	458
Rating (400 V)	461
Drive Mode Unit Monitor Select	982
Drive Model Selection	989
Drive watt loss	40–41
Droop Control	
Parameter	723
dv1	348
dv2	348
Detection condition settings	802
Detection level	805
Detection method settings	805
dv3	348
Detection condition settings	802
dv4	349
Detection condition settings	802
dv7	349
dWA2	373
dWA3	373
dWAL	373
Dwell function	
Parameter	722
dWF1	349
dWF2	349
dWF3	349
dWFL	349
E	
E5	
Fault	350
Minor Fault	373
Operation Selection after Detection	826
EF	374
EF0	
Detection conditions	823
Detection conditions setting (DeviceNet)	829
Fault	350
Minor Fault	374
Operation Selection after Detection	823
EF1	
Fault	350
Minor Fault	374
EF2	
Fault	350
Minor Fault	374
EF3	
Fault	350
Minor Fault	374
EF4	
Fault	350
Minor Fault	374
EF5	
Fault	350
Minor Fault	374
EF6	
Fault	351
Minor Fault	375
EF7	
Fault	351
Minor Fault	375
EF8	
Fault	351
Minor Fault	375
Elapsed Operating Time Selection	994
Electrolytic Capacitor	
Estimated Lifespan	408
Enclosure Type	

Change to IP20/UL Type 1	55
Derating	474, 953
Encoder option	
Parameter	798
End1	387
End2	387
End3	387
End4	387
End5	387
End6	387
End7	387
End8	388
End9	388
Energy-saving control	
Parameter	724
Enter command	309
EP24v	375
Er-01	388
Er-02	388
Er-03	388
Er-04	389
Er-05	389
Er-08	389
Er-09	389
Er-10	389
Er-11	389
Er-12	390
Er-13	390
Er-14	390
Er-15	390
Er-16	390
Er-17	390
Er-18	390
Er-19	390
Er-20	390
Er-21	390
Er-25	391
ERF type braking resistor	
Protective function	948
Wiring	121
Err	351
Error Code List	337
Exterior and mounting dimensions	
Installation dimensions	56
Panel cut out dimensions	56
Exterior and Mounting Dimensions (IP00/UL Open Type)	
Drive	486
Exterior and Mounting Dimensions (IP20/UL Open Type)	
Drive	477–485
Exterior and Mounting Dimensions (IP20/UL Type 1)	
Drive	487–494
Exterior Dimensions Diagram (IP20)	
Drive	496–500
External 24 V power supply	
Power supply input terminals	107
External Cooling Fin	
Derating	474, 953
F	
FAn	
Fault	351
Minor Fault	375
Fan Operation Time Setting	994
FAN1	351
Fast Stop Time	
Parameter	734
Fault	336, 342
Fault code	

MEMOBUS/Modbus.....	328	Auto-Tuning.....	206
Fault Code List	337	Induction motors	
Fault history		Motor Parameters.....	785
Display procedure	184	Inertia Tuning	210
Fault Reset.....	393	Precautions	213
Fault Restart		Input Phase Detection	
Parameter	937	Protection Functions	950
FbH		Input voltage	
Fault	352	Parameter	779
Minor Fault	375	Inspection	
FbL		Drive.....	406
Fault	352	Installation	
Minor Fault	375	Front cover	50
Feed Forward Control		Keypad	44
Parameter	968	Terminal cover	50
Field Forcing		UL Type 1 protective cover.....	55
Parameter	775	Installation dimensions	56
Field weakening		Installation environment.....	34
Parameter	775	Interlock	
Fine tuning	217	Circuit example	120
Finless		Internal Drive Braking Transistor	
Derating.....	474, 953	Protection Functions	955
Firmware update lock.....	678	IP20/UL Type 1	
Freq Ref Setting Method Select	990	Attach protective cover	55
Freq reference bias		J	
Parameter	768	Jog command	762
Frequency Agreement		Jog operation.....	163
Parameter	936	JOG operation.....	163
Frequency reference		Jump frequency	
Command source correlation diagram	756	Parameter	763
LOCAL/REMOTE Run selection	680, 756	Jumper switch.....	114
Making changes using keypad	163	K	
Offset frequency addition.....	776	KEB ride-thru function	
Switching between LOCAL/REMOTE.....	680, 689, 756	Compensation Time	923
Upper and lower frequency limits	762	KEB Method Selection	925
Frequency reference bias		Operation during momentary power loss.....	921
Parameter	764	Parameter	917
Frequency reference hold function		Single Drive KEB Method	925
Parameter	764, 768	System KEB Method.....	925
Fuse rating.....	137	Keypad	
G		Application Preset	204
Gateway Mode.....	818	Backlight setting	199
Getting set up	157	Battery Replacement	447
GF	352	Data log setting	193, 196
Protection Functions	951	Display communication option information	201
Ground		Display drive information	200
Drive.....	90	Display software version	200
Ground Fault Detection		External dimensions.....	45
Protection Functions	951	HOME screen	163
H		Installation.....	44
HCA.....	376	Installation on control panel.....	45
Alarm Settings	955	Language selection	186, 659
HD.....	457	LED status	149
Heavy Duty Rating.....	457	Method of operation.....	149
High-Slip Braking		Remove	44
Parameter	961	Set date and time.....	187
HLCE	352	Set time	187
HOME screen.....	163	Setup Wizard	189
Horsepower	988	Start/stop data logging	191
How to read the model number.....	23	Keypad Display.....	981
Humidity		Keypad Display Selection.....	982
Environment.....	34	Keypad Operation	988
I		Keypad-related settings.....	981
iFcr.....	392	kWh Monitor Initialization.....	995
IGBT Maintenance Setting.....	995	L	
Induction Motor		L24v.....	376

Language selection	659
Procedure	186
LCD contrast adjustment	983
LED Light Function Selection	991
LED status ring	
ALM/ERR	155
Ready	155
RUN	155
LF	352
Protective function	950
LF2	353
Protection Functions	953
LKEB type braking resistor unit	
Wiring	121
Load Inertia Ratio	
Parameter	934
LoG	376
LO/RE Key Function Selection	988
LOCAL/REMOTE indicator	149, 151
LSo	353
Protective function	956–957
LT-1	376
LT-2	376
LT-3	377
LT-4	377
M	
Main circuit terminals	
Configuration of terminal block	72
Line voltage drop	78
Wire gauge	78
Wiring	71
Wiring procedure for terminal block	96
Main menu	
Display procedure	163
Maintenance Period	994
Maximum Output Frequency	
Motor 2 Parameters	789
Parameter	784
Maximum Output Voltage	
Motor 2 Parameters	789
Parameter	784
MCCB	130
Mechanical Weakening Detection	
Parameter	941
MEMOBUS	
Broadcast Messages	327
Command data	311
Communication error code	331
Communication specifications	300
Enter command	309
Fault code	328
Loopback test	306
Minor fault code	330
Monitor data	314
Register reading	305
Register writing	306
Self-diagnosis	310
Wiring	300
MEMOBUS/Modbus Communications	
Parameter	899
Serial communication terminals	109
Setting for termination resistor	118
microSD card	
Disposal	453
Insertion slot	149
Mid point B frequency	
Motor 2 parameters	790

Parameter	785
Mid point B voltage	
Motor 2 parameters	790
Parameter	785
Middle Output Frequency	
Motor 2 Parameters	789
Parameter	784
Middle Output Frequency Voltage	
Motor 2 Parameters	789
Parameter	785
Minimum output frequency	
Parameter	785
Minimum Output Frequency	
Motor 2 Parameters	789
Minimum Output Voltage	
Motor 2 Parameters	790
Parameter	785
Minor Fault	336, 371
Minor fault code	
MEMOBUS/Modbus	330
Minor Fault Code List	337
Modbus	
Broadcast Messages	327
Command data	311
Communication error code	331
Communication specifications	300
Enter command	309
Fault code	328
Loopback test	306
Minor fault code	330
Monitor data	314
Register reading	305
Register writing	306
Self-diagnosis	310
Wiring	300
Molded-case circuit breaker	130
Momentary Power Loss	
KEB Compensation Time	923
Monitors	
Data log setting	193–194, 196
Display analog gauge	168
Display bar graph	166
Display procedure	164
Set custom monitors	165
Show custom monitors	166
Start/stop data logging	191
Trend Plot Display	170
Motor	
Change direction of motor rotation	163
Positive Temperature Coefficient (PTC) Thermistor	911
Wiring	71
Wiring distance	90
Motor 2	
Base Frequency	789
Base voltage	790
Control mode settings	789
Leakage Inductance	792
Line-to-Line Resistance	791
Maximum Output Frequency	789
Maximum Output Voltage	789
Mid point B frequency	790
Mid point B voltage	790
Middle Output Frequency	789
Middle Output Frequency Voltage	789
Minimum Output Frequency	789
Minimum Output Voltage	790
Motor Iron Loss	792

Motor Iron-Core Saturation Coefficient 1	792	oFA13	356
Motor Iron-Core Saturation Coefficient 2	792	oFA14	356
Motor rated power (kW)	792	oFA15	356
No-load Current	791	oFA16	356
Number of motor poles	791	oFA17	356
Rated current	790	oFA30	356
Rated Slip	791	oFA31	356
V/f Pattern	788	oFA32	356
Motor Code Selection	793	oFA33	356
Motor Overheating		oFA34	357
Operation During Detection of Alarms	286, 915	oFA35	357
Operation During Detection of Faults (PTC Input)	287, 915	oFA36	357
Motor Overload		oFA37	357
Electric Thermal Protection Operation Time	286, 914	oFA38	357
Protection Functions	283, 912	oFA39	357
Motor parameters		oFA40	357
Motor 2	790	oFA41	357
Motor 2 Iron-Core Saturation Coefficient 1	792	oFA42	357
Motor 2 Iron-Core Saturation Coefficient 2	792	oFA43	358
Motor 2 number of motor poles	791	oFb00	358
Motor Parameters	778, 785	oFb01	358
Motor 2 Iron Loss	792	oFb02	358
Motor 2 Leakage Inductance	792	oFb03	358
Motor 2 Line-to-Line Resistance	791	oFb04	358
Motor 2 No-load Current	791	oFb05	358
Motor 2 rated Current	790	oFb06	358
Motor 2 rated power (kW)	792	oFb10	358
Motor 2 Rated Slip	791	oFb11	359
Motor parameters (induction motors)	785	oFb12	359
Leakage Inductance	787	oFb13	359
Line-to-Line Resistance	787	oFb14	359
Motor Iron Loss	788	oFb15	359
Motor Iron-Core Saturation Coefficient 1	787	oFb16	359
Motor Iron-Core Saturation Coefficient 2	787	oFb17	359
Motor rated power (kW)	788	oFC00	359
No-load Current	786	oFC01	359
Number of motor poles	787	oFC02	360
Rated current	282, 786	oFC03	360
Rated Slip	786	oFC04	360
Motor Power Unit Selection	988	oFC05	360
MotorDirect@PowUpWhenUsingKeypad	991	oFC06	360
Multi-step speed operation	756	oFC10	360
Setting procedure	756	oFC11	360
Multiple-unit connection	818	oFC12	360
N		oFC13	361
Nameplate	23	oFC14	361
ND	457	oFC15	361
ndAT	392	oFC16	361
Noise filter		oFC17	361
Wiring	135	oFC50	361
Normal Duty Rating	457	oFC51	361
nSE	353	oFC52	361
NumOfRunCommands Counter Initial	995	oFC53	361
O		oFC54	361
oC	353	oFC55	361
Overcurrent Detection Gain	953	Off-Delay Timer	705
oFA00	354	Offset frequency	
oFA01	355	Parameter	776
oFA02	355	oH	
oFA03	355	Alarm Settings	949
oFA04	355	Fault	362
oFA05	355	Minor Fault	377
oFA06	355	oH1	362
oFA10	355	oH2	377
oFA11	355	Alarm Settings	949
oFA12	355	oH3	
		Fault	362

Minor Fault	377	Checking modified parameters	181
Operation During Detection of Alarms	286, 915	Checking user custom parameters	176
oH4	363	Delete Backed-up Parameters	180
Operation During Detection of Faults (PTC Input) ...	287, 915	Restore (Auto Backup).....	202
oL1	363	Restore (keypad to drive).....	178
oL2	364	Restoring default settings.....	182
Protection Functions	952	User-set	679
oL3		Verify (keypad and drive)	179
Fault	364	Parameter Setting Errors	336, 382
Minor Fault	378	PASS	379
oL4		Password	
Fault	364	Setting	663
Minor Fault	378	Verification	662
oL5		PC	
Fault	364	Connection procedure	119
Minor Fault	378	PE1	366
oL7	365	PE2	366
On-Delay Timer	705	Peripheral Devices	501
Ope Select @Keypad is Disconnect	990	PF	367, 379
oPE01	382	Protection Functions	950
oPE02	382	PGo	
oPE03	382	Detection time	802
oPE05	383	Fault	367
oPE06	384	Minor Fault	379
oPE07	384	Operation Selection after Detection	799
oPE08	384	PGoH	
oPE09	385	Detection level	805
oPE10	385	Fault	367
oPE11	385	Level detection (PG1).....	803
oPE13	385	Minor Fault	379
oPE15	386	Phase Order Selection	689
oPE16	386	PID control	707
oPE18	386	control block diagram	709
oPE20	386	Feedback value input.....	708
oPE33	386	fine tuning	710
Operation During Momentary Power Loss		Parameter	712
KEB ride-thru function	917	PID feedback loss detection	709
Operation method selection	921	PID Sleep	710
Parameter	921	Setpoint input	708
Speed Search function	696	PM motor parameters	
oPr	365	d-Axis inductance	794
Option card		Encoder Z pulse offset	795
Parameter	798	Induced voltage constant 1	794
Options.....	501	Induced voltage constant 2	795
oS		Motor rated current	283, 793
Detection level	801	Motor rated power (kW).....	793
Detection time	801	Number of motor poles	794
Fault	365	q-Axis inductance	794
Minor Fault	378	Stator resistance.....	794
Operation Select at Overspeed.....	799	PM Motor Parameters	793
Output Phase Loss Detection		PM motors	
Protective function	950	Auto-Tuning	207
ov		Motor Code Selection	793
Fault	365	PM Motors	
Minor Fault	378	Fine Adjustment	973
ovEr	379	Motor Parameters	793
Overexcitation deceleration		Positive Temperature Coefficient (PTC) Thermistor	911
Parameter	962	Power loss	40–41
Overtorque detection		Protection Functions	
Parameter	940	DC bus undervoltage	923
P		Drive Overheating	949
Panel cut out dimensions	56	GF.....	951
Parameter		Ground Fault Detection	951
Access Level Selection	659	Input Phase Detection	950
Automatic selection	679	Internal Drive Braking Transistor	955
Backup (drive to keypad).....	177	LF2	953
Changing setting values.....	174	Motor Overheating	286, 915

Motor Overload	283, 912	Run Command at Power Up	692
oC	953	Run Command Selection 2	
oH2	949	Switching between LOCAL/REMOTE	691
oH3	286, 915	RUN indicator	149, 151
oL2	952	RUN key	149
Overcurrent	953	S	
Overload	952	S-curve characteristics	
PF	950	Parameter	736
rr	955	Sampling time setting	
Uv1	923	Data log	194–195
Protective function		Trend log	1004
Desynchronization	956	SC	368
Drive Overheating	949	SCF	368
HCA	955	SE	379
LF	950	SEr	368
Low Speed Desynchronization	956–957	Serial communication terminals	
LSo	956–957	MEMOBUS/Modbus Communications	109
Motor Overheating (PTC Input)	287, 915	Set date and time	
oH	949	Operation	187
oH4	287, 915	Set time	
Output Current Overload	955	Operation	187
Output Phase Loss Detection	950	Setup Wizard	
Software Current Limit Selection	952	Operation	189
PSE	367	Short Circuit Braking	
Pulse Train Input		Parameter	693
Terminal RP Function Selection	904	Side-by-side	
Pulse Train Input/Output		Derating	474, 953
Parameter	903	Simple Positioning Stop	768
Pulse train output		Slip compensation	
Terminal MP function selection	905	Parameter	737
Wiring specifications	115	Softcharge Relay Maintenance Set	995
PWEr	392	Software Current Limit Selection	
R		Protective function	952
Rating (200 V)		Software version	
Drive	458	Display procedure	200
Rating (400 V)		Speed Agreement	
Drive	461	Parameter	936
rdEr	392	Speed Detection	
Ready		Parameter	936
LED status	155	Speed Estimation Speed Search	698
Remove		Speed limit	
Front cover	50	Parameter	771
Keypad	44	Speed Search function	
Terminal cover	50	Operation during momentary power loss	921
RESET key	149	Parameter	696
Residual Current Monitor/Residual Current Device		Stall Prevention function	
RCM/RCD	130	Parameter	926
Wiring	130	Stationary Auto-Tuning	
Restore		Induction Motor	206
Parameters (Auto Backup)	202	PM motors	207
Parameters (keypad to drive)	178	Precautions	213
Reverse Operation Selection	686	Stationary Auto-Tuning for Line-to-Line Resistance	206
rF	367	Precautions	213
rH	367	Stator resistance Auto-Tuning	207
RJ-45 connector	149	Precautions	213
Rotational Auto-Tuning		STo	380
Induction Motor	206	SToF	380
PM motors	207	Stop command	
Precautions	212	LOCAL/REMOTE Run selection	682
rr	368	STOP key	149
Protection Functions	955	STOP Key Function Selection	989
rUn	379	Stop Position Gain	770
RUN		Stopping Method Selection	682
LED status	155	STPo	368
Run command		Surge protective device	
LOCAL/REMOTE Run selection	682	Connection	134
Switching between LOCAL/REMOTE	682	SvE	369

T	
Temperature	
Environment	34
Terminal block	110
Configuration of main circuit terminal block	72
Control circuit terminal block functions	105
I/O terminals function selection switches	114
Terminal function selection	116
Terminal A1	114, 116
Terminal A2	114, 116
Terminal A3	114, 117
Terminal AM	114, 117
Terminal FM	114, 117
Terminal screw	
Screwdriver	14
Termination resistor	
Setting switch	118
Test run	
Checklist	224
Fine tuning	217
Procedure	157
Procedure for no-load test run	215
Procedure for test run with actual load	215
Thermal overload relay	
Connection	131
Tightening torque	
Control circuit terminals	110
Main circuit terminals	78
TiM	
Fault	369
Minor Fault	380
Timer function	
Parameter	705
Torque compensation	
Parameter	771
Torque Compensation	
Parameter	741
Torque Control	
Parameter	770
Switching to/from Speed Control	773
Torque limit function	
Parameter	945
Torque reference	
Parameter	771
Trend log	
Data log setting	195
Sampling time setting	1004
Trend Plot	
Monitors	170
Troubleshooting	
Code Displayed	337
No Code Displayed	394
Troubleshooting without Fault Display	394
TrPC	380
Tuning	731
U	
U2, U3 Initialization	995
UL3	
Fault	369
Minor Fault	380
UL4	
Fault	369
Minor Fault	380
UL5	
Fault	369
Minor Fault	380
Undertorque detection	
Parameter	940
Unit of measurement setting	
Acceleration and deceleration times	734
Unit selector	988
Up 2 command	
Parameter	764, 768
Up command	846–847
Parameter	764, 768
USB port	149
Connecting a PC	119
User Monitor Select afterPowerUp	982
User Parameter Default Value	989
User-Set Display Units Max Value	983
User-SetDisplayUnits Dec Display	984
Uv	380
Speed Search Selection at Start	704
Uv1	369
Detection level settings	923
Uv2	370
Uv3	370
V	
vAEr	392
V/f Pattern	778
Second Motor	788
V/f Pattern Display Unit	983
Verify	
Parameters (keypad and drive)	179
vFyE	392
Vibration-resistant	34
W	
WEEE	453
Wire gauge	
Control circuit terminals	110
Main circuit terminals	78
Voltage drop	78
Wiring	130
AC reactor	133
Braking Resistor	121
Checklist	141
Control circuit terminal block	111
Control circuit terminals	104
DC reactor	133
Main circuit terminal block	96
Main circuit terminals	71
MEMOBUS/Modbus	300
Motor	71
Noise filter	135
Thermal overload relay	131
Wiring distance	
Drive and motor	90
Z	
Z pulse Auto-Tuning	207
Zero Servo function	
Parameter	729

Revision History

Date of Publication	Revision Number	Section	Revised Content
October 2023	8	All	Revision: Reviewed and corrected entire documentation. Upgraded drive software version to PRG: 01034, 01035, and 01037. Addition: Larger drive capacities added along with corresponding data. • Three-Phase 400 V: CIPR-GA70x4810 to 4H12
January 2022	7	All	Revision: Reviewed and corrected entire documentation.
		10	Revision: Reviewed and corrected "Estimated Weight".
March 2020	6	All	Revision: Reviewed and corrected entire documentation. Upgraded drive software version to PRG: 01029.
October 2017	5	1, 11	Revision: Reviewed and corrected the contents.
September 2017	4	All	Revision: Reviewed and corrected entire documentation.
		2	Revision: Reviewed and corrected "Drive Watt Loss".
February 2017	3	All	Revision: Reviewed and corrected entire documentation. Upgraded drive software version to PRG: 01020. Addition: Larger drive capacities added along with corresponding data. • Three-Phase 200 V: CIPR-GA70x2360 and 2415 • Three-Phase 400 V: CIPR-GA70x4371 to 4675
		2, 4	Addition: IP20 Applicable Gauge added to "Main Circuit Wire Gauges and Tightening Torques".
November 2016	2	All	Revision: Reviewed and corrected entire documentation. Upgraded drive software version to PRG: 01018. Addition: Larger drive capacities added along with corresponding data. • Three-Phase 200 V: CIPR-GA70x2070 to 2313 • Three-Phase 400 V: CIPR-GA70x4044 to 4296
June 2016	1	All	Revision: Reviewed and corrected entire documentation. Upgraded drive software version to PRG: 01011.
April 2016	–	–	First Edition

GA700 Series

Technical Manual

YASKAWA EUROPE GmbH

Philipp-Reis-Str. 6, 65795 Hattersheim
am Main, Germany
Phone: +49-6196-569-300
E-mail: support@yaskawa.eu.com
www.yaskawa.eu.com

YASKAWA AMERICA, INC.

2121, Norman Drive South, Waukegan,
IL 60085, U.S.A.
+1-800-YASKAWA (927-5292)
www.yaskawa.com

DRIVE CENTER (INVERTER PLANT)

2-13-1, Nishimiyaichi, Yukuhashi,
Fukuoka, 824-8511, Japan
Phone: +81-930-25-2548
www.yaskawa.co.jp

In the event that the end user of this product is to be the military and said product is to be employed in any weapons systems or the manufacture thereof, the export will fall under the relevant regulations as stipulated in the Foreign Exchange and Foreign Trade Regulations. Therefore, be sure to follow all procedures and submit all relevant documentation according to any and all rules, regulations and laws that may apply.

Specifications are subject to change without notice for ongoing product modifications and improvements.

Original instructions.

© 2016 YASKAWA Electric Corporation

YASKAWA ELECTRIC CORPORATION

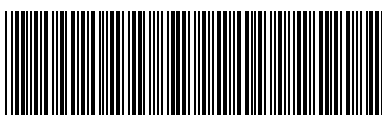

SIEPC71061705

SIEPC71061705

Revision: I <8>-0

October 2023

Published in Japan

23-2-11_YEU

YASKAWA

YASKAWA AC Drive GA700 Supplemental Technical Manual

Introduction

Thank you for purchasing YASKAWA AC Drive GA700.

This supplemental technical manual describes the functions added or changed with a GA700 software upgrade, and should be read to ensure proper usage. Read this manual together with the manual (TOEP C710617 xx) included with the product and the GA700 Technical Manual (SIEP C710617 xx) that can be found on our documentation website. Observe the safety messages and precautions to ensure correct application of the product.

Applicable Software Version

This manual applies to GA700 for software versions S1038 or later.

The software version is indicated on the nameplate affixed to the side of the product, and also can be viewed by using monitor parameter U1-25.

Modified Contents

This supplemental manual explains about these modifications:

1. A parameter that is not initialized by A1-03=2220, 3330 [2-Wire Initialization, 3-Wire Initialization] has been added
2. The C6-05 [Carrier Freq Proportional Gain] setting range has been changed
3. Support of Ethernet/IP protocol Forward Close command operation (F7-43 [PLC Communication Disconnect Selection] has been added)
4. CE [Modbus Communication Error] detection function has been expanded (H5-05=2 [CE Detection: Enabled During Run])
5. Operation of the output voltage limit operating range when PM motor energy-saving control is disabled has been improved (nA-04 [Output Voltage Limit q-Axis Current Command Reference Switch Hysteresis] has been added)
6. Adjustment parameters for PM motor control have been added (E5-08 [PM q-Axis Inductance (at Flux Saturation)], n8-71 [Speed Observer Control D Gain], n8-91 [Id Limit at Output Voltage Limit])
7. Parameter description details used in fine-tuning during test run have been changed
8. Troubleshooting description details when the power supply for the fan and inrush current prevention circuit fails have been changed

1. A parameter that is not initialized by A1-03=2220, 3330 [2-Wire Initialization, 3-Wire Initialization] has been added

A1-12 [Bluetooth ID] has been added to parameters that are not initialized by A1-03=2220, 3330 [2-Wire Initialization, 3-Wire Initialization]. (Underlined parts are added items)

No.	Name
A1-00	Language Selection
A1-02	Control Method Selection
A1-07	DriveWorksEZ Function Selection
A1-12	<u>Bluetooth ID</u>
E1-03	V/f Pattern Selection
...	...

2. The C6-05 [Carrier Freq Proportional Gain] setting range has been changed

The upper limit value of C6-05 [Carrier Freq Proportional Gain] which is the gain to linearly change the carrier frequency depending on the output frequency has been changed to 300. (Underlined parts are changed items)

No. (Hex.)	Name	Description	Default Setting (Range)
C6-05 (0227)	Carrier Freq Proportional Gain	<div style="display: flex; gap: 5px;"> V/f CL-V/f OLV CLV AOLV OLV/PM AOLV/PM CLV/PM EZOLV </div> <p>Sets the proportional gain for the carrier frequency. Set C6-02 = F [Carrier Frequency Selection = User Defined (C6-03 to C6-05)] to set this parameter.</p>	Determined by C6-02 (0 - <u>300</u>)

3. Support of Ethernet/IP protocol Forward Close command operation

Operation stop/run continuous operation when the Forward Close command in the EtherNet/IP protocol is received while the drive is running can be selected at F7-43 [PLC Communication Disconnect Selection].

No. (Hex.)	Name	Description	Default Setting (Range)
F7-43 (1BCE)	PLC Communication Disconnect Selection	<div style="display: flex; gap: 5px;"> V/f CL-V/f OLV CLV AOLV OLV/PM AOLV/PM CLV/PM EZOLV </div> <p>Sets the operation when the Forward Close command (PLC communication disconnect command) in the Ethernet/IP protocol is received from the network during run. 0: Operation continued 1: Clear Run command from communication option 2: bUS [Option Communication Error]</p>	0 (0 - 2)

4. CE [Modbus Communication Error] detection function has been expanded

Option 2 [Enabled during Run] has been added to H5-05 [Comm Fault Detection Selection] and the detection function of CE [MEMOBUS Communication Error] has been expanded. (Underlined parts are changed items)

No. (Hex.)	Name	Description	Default Setting (Range)
H5-05 (0429)	Comm Fault Detection Selection	<p>V/f CL-V/f OLV CLV AOLV OLV/PM AOLV/PM CLV/PM EZOLV</p> <p>Sets the function that detects CE [Modbus Communication Error] issues during MEMOBUS/Modbus communications.</p> <p>0: Disabled Does not detect CE. The drive continues operation.</p> <p>1: Enabled Detects CE. If the drive detects CE, it will operate as specified by the setting of H5-04 [Communication Error (MEMOBUS/Modbus Communication Error) Stop Method].</p> <p><u>2: Enabled during Run</u> <u>If the drive detects CE during Run, it will operate as specified by the setting of H5-04 [Communication Error (MEMOBUS/Modbus Communication Error) Stop Method]. If the drive detects CE while it is stopped, it will detect a CE minor fault.</u></p>	1 (0 - <u>2</u>)

5. Operation of the output voltage limit operating range when PM motor energy-saving mode is disabled has been improved

A function for suppressing shock has been added as shock sometimes occurs on some PM motors at the output voltage limit with b8-01=0 [Energy Saving Control Disabled] set. Sets the switch hysteresis of the q-axis current command referenced to the d-axis current command at nA-04 [Output Voltage Limit q-Axis Current Switch Hysteresis]. Usually it is not necessary to change this parameter.

No. (Hex.)	Name	Description	Default Setting (Range)
nA-04 (1BF5) Expert	Output Voltage Limit q-Axis Current Command Reference Switch Hysteresis	<p>V/f CL-V/f OLV CLV AOLV OLV/PM AOLV/PM CLV/PM EZOLV</p> <p>Sets the switch hysteresis of the q-axis current command referenced to the d-axis current command to suppress shock at the output voltage limit. Sets the switch hysteresis of the q-axis current command as a percentage of motor rated current.</p>	-10% (-20% - 0%)

6. Adjustment parameters for PM motor control have been added

E5-08 [PM q-Axis Inductance (at Flux Saturation)], n8-71 [Speed Observer Control D Gain], and n8-91 [Id Limit at Output Voltage Limit] have been added as adjustment parameters for PM motor control. The adjustment procedure is given in "7. Parameter description details used in fine-tuning during test run have been changed."

No. (Hex.)	Name	Description	Default Setting (Range)
E5-08 (0330) Expert	PM q-Axis Inductance (Lq at Flux Saturation)	<div style="display: flex; justify-content: space-between; font-size: small;"> V/f CL-V/f OLV CLV AOLV OLV/PM AOLV/PM CLV/PM EZOLV </div> <p>Sets the q-axis inductance (Lq at flux saturation) that the drive uses for speed estimation. Adjust this parameter when STPo [Motor Step-Out Detected] or OC [Overcurrent] occurs.</p>	0.00 mH (0.00 mH - 600.00 mH)
n8-71 (065F) Expert	Speed Observer Control D Gain	<div style="display: flex; justify-content: space-between; font-size: small;"> V/f CL-V/f OLV CLV AOLV OLV/PM AOLV/PM CLV/PM EZOLV </div> <p>Sets the derivative gain that the drive uses for speed estimation. Adjust this parameter when STPo [Motor Step-Out Detected] or OC [Overcurrent] occurs.</p>	5.00 (0.00 - 10.00)
n8-91 (02F7) Expert	Id Limit at Output Voltage Limit	<div style="display: flex; justify-content: space-between; font-size: small;"> V/f CL-V/f OLV CLV AOLV OLV/PM AOLV/PM CLV/PM EZOLV </div> <p>Sets the Id limit value at output voltage limit. Adjust this parameter when STPo [Motor Step-Out Detected] or OC [Overcurrent] occurs.</p>	-50% (-200% - 0%)

7. Parameter description details used in fine-tuning during test run have been changed

Because of "3. Adjustment parameters for PM motor control have been added," n8-91 [Id Limit at Output Voltage Limit], n8-71 [Speed Observer Control D Gain] and E5-08 [PM q-Axis Inductance (Lq at Flux Saturation)] have been added to the parameters that are used for fine-tuning during a test run in the "Open Loop Vector Control for PM" and "Advanced Open Loop Vector Control Method for PM Motors" modes. N8-69 [Speed Observer Control P Gain], n8-39 [HFI LPF Cutoff Freq] and n8-11 [Observer Calculation Gain 2] have also been added to enable flexible fine-tuning during test run. (Underlined parts in the table below are added items)

◆A1-02=5 [OLV/PM: Open Loop Vector Control for PM Mode]

Issue	Parameter Number	Possible Solutions	Default	Recommended Setting
The drive detected stalling, STPo [Motor Step-Out Detected] or OC [Overcurrent] at high speed and maximum output voltage.	N8-62 [Output Voltage Limit Level]	Set to a value lower than the actual input voltage.	<ul style="list-style-type: none"> 200.0V 400.0V 	Set this parameter lower than the input power supply voltage.
	<u>n8-91 [Id Limit at Output Voltage Limit]</u> *1	<u>Decrease the setting in -5%-unit decrements.</u>	<u>-50%</u>	<u>-150% to -50%</u>

*1 n8-91 [Id Limit at Output Voltage Limit] is enabled on drives with software versions PRG:01038 and later.

◆ A1-02=6 [AOLV/PM: Advanced Open Loop Vector Control for PM Mode]

Issue	Parameter Number	Possible Solutions	Default	Recommended Setting
<u>Hunting or fault occurs when the load/speed fluctuates. (Fault is detected at impact load)</u>	<u>n8-69 [Speed Observer Control P Gain]</u>	<ul style="list-style-type: none"> • If torque or speed response are slow, increase the setting value in 0.20 increments. • If hunting or oscillation occurs, decrease the setting value in 0.20 decrements. 	<u>1.00</u>	<u>0.20 - 5.00</u>
	<u>n8-71 [Speed Observer Control D Gain]*2</u>	Decrease the setting in 0.50-unit decrements.	<u>5.00</u>	<u>1.00 - 5.00</u>
	<u>E5-08 [PM q-Axis Inductance (Lq at Flux Saturation)]*2</u>	<ul style="list-style-type: none"> • Set the q-axis inductance value at flux saturation shown on the motor nameplate or test report. • Set the value of <u>E5-06 [PM q-Axis Inductance]</u> and increase the setting value until vibration is suppressed. (Set <u>E5-08</u> within the range of values of <u>E5-06</u> and <u>E5-07</u>. The function is disabled when the value is set to <u>0.00</u>.) 	<u>0.00 mH</u>	<u>E5-06 and E5-07</u>
<u>Hunting, vibration or abnormal noise from the motor occurs when n8-57=1 [High Frequency Injection Function: Enabled]</u>	<u>n8-39 [HFI LPF Cutoff Freq]</u>	Set the setting value to 50% of the setting value of <u>n8-36 [HFI Frequency Level for L Tuning]</u> .	<u>250 Hz</u>	<u>50% of n8-36 [HFI Frequency Level for L Tuning]</u>
<u>Speed drops when a load is applied. (When a torque limit state has not occurred)</u>	<u>n8-11 [Observer Calculation Gain 2]</u>	Decrease the setting in 10-unit decrements.	<u>Determined by n8-72</u>	<u>50.0 - 300.0</u>

*2 n8-71 [Speed Observer Control D Gain] and E5-08 [PM q-Axis Inductance (Lq at Flux Saturation)] are enabled on drives with software versions PRG:01038 and later.

8. Troubleshooting description details when the power supply for the fan and inrush current prevention circuit fails have been changed

The troubleshooting description details for when the power supply for the fan and inrush current prevention circuit has failed have been added. (Underlined parts are changed items)

One of the FAn1 [Drive Cooling Fan Failure], Uv1 [DC Bus Undervoltage] and Uv3 [Soft Charge Answerback Fault] faults or a Uv [DC Bus Undervoltage] minor fault is detected when the power supply for the fan and inrush current prevention circuit has failed.

Faults

◆FAn1 [Drive Cooling Fan Fault]

Code	Name	Causes	Possible Solutions
FAn1	Drive Cooling Fan Fault	The cooling fan stopped operating correctly.	<ul style="list-style-type: none"> Examine cooling fan operation. Re-energize the drive. Examine U4-03 [Cooling Fan Ope Time] and U4-04 [Cool Fan Maintenance]. If the performance life of the cooling fan is expired or if there is damage to the fan, replace the fan.
		The circulation fan is damaged.	<ul style="list-style-type: none"> Examine circulation fan operation. Re-energize the drive. Examine U4-03 [Cooling Fan Ope Time] and U4-04 [Cool Fan Maintenance]. If the performance life of the circulation fan is expired or if there is damage to the circulation fan, replace the circulation fan.
		<u>The power supply for the fan and inrush current prevention circuit has failed.</u> (Models 2257 to 2415, 4208 to 4H12)	<ul style="list-style-type: none"> <u>Re-energize the drive and check to see if the fault stays.</u> <u>If the fault stays, replace the control board or the drive. For information about replacing the control board, contact Yaskawa or your nearest sales representative.</u>

◆Uv1 [DC Bus Undervoltage]

Code	Name	Causes	Possible Solutions
Uv1	DC Bus Undervoltage	There is a phase loss in the drive input power.	Correct errors with the wiring for main circuit drive input power.
		There is loose wiring in the drive input power terminals.	Tighten the terminal screws to the correct tightening torque.
		The drive input power voltage is changing too much.	<ul style="list-style-type: none"> Examine the input power for problems. Make the drive input power stable.
		There was a loss of power.	Use a better power supply.
		The main circuit capacitors have become unserviceable.	Examine the capacitor maintenance time in monitor U4-05 [CapacitorMaintenance]. If U4-05 is more than 90%, replace the control board or the drive. For information about replacing the control board, contact Yaskawa or your nearest sales representative.
		The relay or contactor on the soft-charge bypass relay is damaged.	U4-06 [PreChargeRelayMainte] shows the performance life of the soft-charge bypass relay. If U4-06 is more than 90%, replace the control board or the drive. For information about replacing the board, contact Yaskawa or your nearest sales representative.
		<u>The power supply for the fan and inrush current prevention circuit has failed.</u> (Models 2257 to 2415, 4208 to 4H12)	<ul style="list-style-type: none"> <u>Re-energize the drive and check to see if the fault stays.</u> <u>If the fault stays, replace the control board or the drive. For information about replacing the control board, contact Yaskawa or your nearest sales representative.</u>

◆Uv3 [Soft Charge Answerback Fault]

Code	Name	Causes	Possible Solutions
Uv3	Soft Charge Answerback Fault	There is damage to the relay or contactor on the soft-charge bypass relay.	<ul style="list-style-type: none"> • Re-energize the drive. • If the fault stays, replace the control board or the drive. • Monitor U4-06 [PreChargeRelayMainte] shows the performance life of the soft-charge bypass relay. If U4-06 is more than 90%, replace the control board or the drive. For information about replacing the control board, contact Yaskawa or your nearest sales representative.
		<u>The power supply for the fan and inrush current prevention circuit has failed. (Models 2257 to 2415, 4208 to 4H12)</u>	<ul style="list-style-type: none"> • <u>Re-energize the drive and check to see if the fault stays.</u> • <u>If the fault stays, replace the control board or the drive. For information about replacing the control board, contact Yaskawa or your nearest sales representative.</u>

Minor fault

◆Uv [Undervoltage]

Code	Name	Causes	Possible Solutions
Uv	Undervoltage	The drive input power voltage is changing too much.	<ul style="list-style-type: none"> • Examine the input power for problems. • Make the drive input power stable. • If the input power supply is good, examine the magnetic contactor on the main circuit side for problems.
		There is a phase loss in the drive input power.	Correct errors with the wiring for main circuit drive input power.
		There is loose wiring in the drive input power terminals.	Tighten the terminal screws to the correct tightening torque.
		There was a loss of power.	Use a better power supply.
		The main circuit capacitor circuit has become unserviceable.	Examine the capacitor maintenance time in monitor U4-05 [CapacitorMaintenance]. If U4-05 is more than 90%, replace the control board or the drive. For information about replacing the control board, contact Yaskawa or your nearest sales representative.
		The drive input power transformer is too small, and voltage drops when the power is switched on.	<ul style="list-style-type: none"> • Check for an alarm when a molded-case circuit breaker, leakage breaker (ELCB, GFCI, or RCM/RCD) (with overcurrent protective function), or magnetic contactor is ON. • Check the capacity of the drive power supply transformer.
		Air inside the drive is too hot.	Check the ambient temperature of the drive.
		The Charge LED is broken.	Replace the board or the entire drive. For information about replacing the control board, contact Yaskawa or your nearest sales representative.
		<u>The power supply for the fan and inrush current prevention circuit has failed. (Models 2257 to 2415, 4208 to 4H12)</u>	<ul style="list-style-type: none"> • <u>Re-energize the drive and check to see if the fault stays.</u> • <u>If the fault stays, replace the control board or the drive. For information about replacing the control board, contact Yaskawa or your nearest sales representative.</u>

YASKAWA AC Drive GA700 Supplemental Technical Manual

Introduction

Thank you for purchasing YASKAWA AC Drive GA700.

This supplemental technical manual describes the functions added or changed with a GA700 software upgrade, and should be read to ensure proper usage. Read this manual together with the manual (TOEP C710617 xx) included with the product and the GA700 Technical Manual (SIEP C710617 xx) that can be found on our documentation website. Always observe the safety messages and precautions to ensure correct application of the product.

Applicable Model

This manual applies to GA700 for software versions S1040 or later.

The software version is indicated on the nameplate affixed to the side of the product, and also can be viewed by using monitor parameter U1-25.

Modified Contents

This supplemental manual explains about these modifications:

1. Addition of A1-00 [Language Selection]=13 [Korean]
2. Addition of time related monitor
(U5-30 [Time hours/minutes HHMM], U5-31 [Date year], U5-32 [Date month/day MMDD], U5-33 [Date day of week])
3. Support of emergency operation function at cooling fan fault
4. Improvement of PM Advanced Open Loop Vector (AOLV/PM) (addition of nA-07 to nA-10)
5. Improvement of PM control voltage limit function (addition of n8-68 [Output Voltage Limit Level 1], nA-11 [Output Voltage Limit Level 2])

1. Addition of A1-00 [Language Selection]=13 [Korean]

A1-00 [Language Selection] = 13 [Korean] has been added. (Underlined part indicates added language.)

No. (Hex.)	Name	Description	Default Setting (Range)
A1-00 (0100) RUN	Language Selection	<p>V/f CL-V/f OLV CLV AOLV OLV/PM AOLV/PM CLV/PM EZOLV</p> <p>Sets the language for the LCD keypad. Note: When you use A1-03 [Initialize Parameters] to initialize the drive, the drive will not initialize this parameter. 0: English 1: Japanese 2: German 3: French 4: Italian 5: Spanish 6: Portuguese 7: Chinese 8: Czech 9: Russian 10: Turkish 11: Polish 12: Greek 13: Korean</p>	0 (0 - <u>13</u>)

2. Addition of time related monitor (U5-30 [Time hours/minutes HHMM], U5-31 [Date year], U5-32 [Date month/day MMDD], U5-33 [Date day of week])

A monitor capable of displaying the preset time/date/day of week (U5-30 [Time hours/minutes HHMM], U5-31 [Date year], U5-32 [Date month/day MMDD], U5-33 [Date day of week]) has been added. When setting the date, set whether or not to connect the LCD keypad to make the setting from MEMOBUS Communication.

Note: · The date cannot be set while the LED keypad is connected.

- If the LCD keypad does not have a clock battery, you must set the date and time each time you energize the drive.

No. (Hex.)	Name	Description	MFAO Signal Level
U5-30 (3000)	Time hours/minutes HHMM	<p>V/f CL-V/f OLV CLV AOLV OLV/PM AOLV/PM CLV/PM EZOLV</p> <p>Time (hours/minutes) is displayed in the format "HH:MM". Set the time display format at o4-22 [Time Format].</p>	No signal output available
U5-31 (3001)	Date year	<p>V/f CL-V/f OLV CLV AOLV OLV/PM AOLV/PM CLV/PM EZOLV</p> <p>Year is displayed in the format "YYYY".</p>	No signal output available
U5-32 (3002)	Data month/day	<p>V/f CL-V/f OLV CLV AOLV OLV/PM AOLV/PM CLV/PM EZOLV</p> <p>Month and day are displayed in the format "MM/DD".</p>	No signal output available
U5-33 (3003)	Date day of week	<p>V/f CL-V/f OLV CLV AOLV OLV/PM AOLV/PM CLV/PM EZOLV</p> <p>Shows the day of the week.</p>	No signal output available

◆ **Related MEMOBUS command data**

Note: · The date cannot be set while the LED keypad is connected.

· If the LCD keypad does not have a clock battery, you must set the date and time each time you energize the drive.

Register Number (Hex.)	Description
3004	Time Setting Setting range: 0000 to 2359 (decimal), the default value at energizing: 0000 Set the hour and the minute in HHMM format. <ul style="list-style-type: none"> • HH: 00 to 23 (decimal) • MM: 00 to 59 (decimal)
3005	Year and Day Setting Setting range: 1600 to 9906 (decimal), the default value at energizing: 1600 Sets the year and the day of the week in YYDW format. <ul style="list-style-type: none"> • YY: the last two digits of the year from 16 to 99 (decimal) • DW: the day of the week <ul style="list-style-type: none"> - Sunday: 00 - Monday: 01 - Tuesday: 02 - Wednesday: 03 - Thursday: 04 - Friday: 05 - Saturday: 06
3006	Date Setting Setting range: 101 to 1231 (decimal), the default value at energizing: 101 Sets the month and the date in MMDD format. <ul style="list-style-type: none"> • MM: 01 to 12 (decimal) • DD: 01 to 31 (decimal)
3007	Set the Date Information Setting range: 0 to 8 (decimal), the default value at energizing: 8 Sets the values specified in 3004H to 3006H as the date and time. <ul style="list-style-type: none"> • Command Data: 1 • Response Data: 0 (normal), 8 (fault)

3. Support of Emergency Operation Function at Cooling Fan Fault

◆ Section Safety

Damage to Equipment

When using the drive after changing L9-29 [FAn1 Detection Selection] from the default setting (1: Coast to Stop), understand the precautions given in parameter description details.

During a fan failure, the cooling function of the drive decreases considerably. For this reason, the temperature inside the drive becomes higher than normal which can cause damage to the drive or shorten the life of the drive.

◆ Parameter

Drive operation when the drive detects FAn1 [Drive Cooling Fan Fault] can be selected at L9-29 [FAn1 Detection Selection].

No. (Hex.)	Name	Description	Default Setting (Range)
L9-29 (1BF7) Expert	FAn1 Detection Selection	<p>V/f CL-V/f OLV CLV AOLV OLV/PM AOLV/PM CLV/PM EZOLV</p> <p>Sets operation when the drive detects FAn1 [Drive Cooling Fan Fault]. Usually it is not necessary to change this parameter.</p> <p>Note:</p> <ul style="list-style-type: none"> Setting value 5 is outside the scope of the product warranty. Use this value only when short-time emergency operation is required when a fan failure occurs. This function enables only short-time operation that does not activate oH1 [Heatsink Overheat], oL2 [Drive Overloaded] and other protection functions. During normal operation, set L9-29 = 1. When a FAn1 fault occurs, set L9-29 = 5 and perform emergency operation after the drive has stopped. When setting value 5 is selected, the drive detects a FAn1 alarm at all times and displays "FAn1" on the keypad so that the user is aware that emergency operation is in progress. Be sure to set Alarm (10) to MFDO (H2-xx) so that detection is performed at the host controller. During emergency operation, the cooling function of the drive decreases considerably. For this reason, the temperature inside the drive becomes higher than normal which can cause damage to the drive or shorten the life of the drive. To reduce increased temperature inside the drive, it is recommended to forcefully feed in air from the outside. Immediately after emergency operation is completed, stop the drive and replace the cooling fan. <p>1: Coast to Stop 5: Emergency Operation</p>	1 (1, 5)

◆ **Multi-Function Digital Output**

The names of the following function have been changed. (The underlined part in the table below is the added item)

Setting Value	Function	Description
60	<u>During Detection of Drive Cooling Fan Fault</u>	<div style="display: flex; justify-content: space-between; align-items: center;"> V/f CL-V/f OLV CLV AOLV OLV/PM AOLV/PM CLV/PM EZOLV </div> <p>The terminal activates when the drive detects a drive cooling fan fault.</p>

◆ **MEMOBUS Command Data**

The bit assignments of the following register numbers have been changed. (Underlined part in the table below is the added item)

Register number (Hex.)	Description	
00CE	Minor Fault Description 7	
	bit0 - 4	Reserved
	<u>bit5</u>	<u>FAn1 [Drive Cooling Fan Fault]</u>
	bit6 - F	Reserved

◆ **Related MEMOBUS Command Data**

Register number (Hex.)	Description	
00EE	Fault Description 12	
	bit0 - 1	Reserved
	bit2	FAn1 [Drive Cooling Fan Fault]
	bit3	CP1 [Comparator 1 Limit Fault]
	bit4	CP2 [Comparator 2 Limit Fault]
	bit5	bCE [Bluetooth Communication Fault]
	bit6 - F	Reserved

◆ **Troubleshooting**

The following alarm has been added. (Underlined parts in the table below are added items)

[Alarm]

◆ **FAn1 [Drive Cooling Fan Fault]**

Code	Name	Cause	Possible Solutions
FAn1	<u>Drive Cooling Fan Fault</u>	<u>The cooling fan is damaged.</u>	<ul style="list-style-type: none"> • <u>Examine cooling fan operation.</u> • <u>Re-energize the drive.</u> • <u>Examine U4-03 [Cooling Fan Ope Time] and U4-04 [Cool Fan Maintenance]. If the performance life of the cooling fan is expired or if there is damage to the fan, replace the fan.</u>
		<u>The circulation fan is damaged.</u>	<ul style="list-style-type: none"> • <u>Examine circulation fan operation.</u> • <u>Re-energize the drive.</u> • <u>Examine U4-03 [Cooling Fan Ope Time] and U4-04 [Cool Fan Maintenance]. If the performance life of the circulation fan is expired or if there is damage to the circulation fan, replace the circulation fan.</u>
		<u>The power supply for the fan and inrush current prevention circuit has failed. (Models 2257 to 2415, 4208 to 4H12)</u>	<ul style="list-style-type: none"> • <u>Re-energize the drive and check to see if the alarm stays.</u> • <u>If the alarm stays, replace the control board or the drive. For information about replacing the control board, contact Yaskawa or your nearest sales representative.</u>
Note: <ul style="list-style-type: none"> • <u>If the drive detects this alarm, the terminal set to H2-xx = 10 [MFDO Function Select = Alarm] will activate.</u> • <u>When 5 [Emergency Operation] is set to L9-29 [FAn1 Detection Selection], the drive detects a FAn1 alarm at all times and displays "FAn1" on the keypad so that the user is aware that emergency operation is in progress.</u> 			

4. Improvement of PM Advanced Open Loop Vector (AOLV/PM) (addition of nA-07 to 10)

The performance of the PM advanced open loop vector has been improved. If adjustment is necessary, change and adjust the following parameters. Usually it is not necessary to change this parameter.

No. (Hex.)	Name	Description	Default Setting (Range)
nA-07 (3170) Expert	Drive Method Switch Speed	<p>V/f CL-V/f OLV CLV AOLV OLV/PM AOLV/PM CLV/PM EZOLV</p> <p>Sets the speed that the drive method is switched. Usually it is not necessary to change this parameter. Note: This parameter is enabled when nA-07≠0.0%.</p>	0.0% (0.0 – 100.0%)
nA-08 (3171) Expert	Drive Method Switch Hysteresis Band	<p>V/f CL-V/f OLV CLV AOLV OLV/PM AOLV/PM CLV/PM EZOLV</p> <p>Sets the hysteresis band that the drive method is switched. The drive method is switched by nA-07 [Drive Method Switch Speed] to nA-07+nA-08. Usually it is not necessary to change this parameter. Note: This parameter is enabled when nA-07≠0.0%.</p>	0.0% (0.0 – 100.0%)
nA-09 (3172) Expert	Stop Condition Selection	<p>V/f CL-V/f OLV CLV AOLV OLV/PM AOLV/PM CLV/PM EZOLV</p> <p>Sets the criteria that the drive uses to judge a stop. Usually it is not necessary to change this parameter. 0: Output Frequency 1: SFS Output Frequency Note: <ul style="list-style-type: none"> This parameter is enabled when n8-72 [Speed Estimation Method Select] = 0 [Method 1] and n8-57 [HFI Overlap Selection] = 0 [HFI Overlap Selection = Disabled]. If nA-09 = 0 is set, set nA-10 [Minimum Output Frequency Limit] = 1 [Enabled]. If nA-09 = 0 and nA-10 = 0 [Disabled], the drive will detect oPE08 [Parameter Selection Error]. </p>	0 (0 - 1)
nA-10 (3173) Expert	Minimum Output Frequency	<p>V/f CL-V/f OLV CLV AOLV OLV/PM AOLV/PM CLV/PM EZOLV</p> <p>If nA-10 = 0 [Disabled], a value 5% or less of E1-06 [Base Frequency] can be set to E1-09 [Minimum Output Frequency]. Usually it is not necessary to change this parameter. 0: Disabled 1: Enabled Note: <ul style="list-style-type: none"> This parameter is enabled when n8-57 = 0 [Overlap Selection = Disabled]. If nA-09 [Stop Condition Selection] = 0 [Output Frequency], set nA-10 = 1. If nA-09 = 0 and nA-10 = 0 [Disabled], the drive will detect oPE08 [Parameter Selection Error]. </p>	1 (0 - 1)

◆ Troubleshooting

The following cause has been added. (Underlined part in the table below is added item)

Code	Name	Cause	Possible Solutions
oPE08	Parameter Selection Error	When <u>A1-02 = 6 [PM Advanced Open Loop Vector]</u> , you used these parameter settings: · If <u>nA-09 [Stop Condition Selection] = 0 [Output Frequency]</u> · <u>nA-10 [Minimum Output Frequency] = 0 [Disabled]</u>	<u>Correct the parameter settings.</u>

5. Improvement of PM control voltage limit function (addition of n8-68 [Output Voltage Limit Level 1], nA-11 [Output Voltage Limit Level 2])

A function that allows you to set a limit value to the output voltage has been added to prevent saturation of the output voltage. Usually it is not necessary to change this parameter.

No. (Hex.)	Name	Description	Default Setting (Range)
n8-68 (0237) Expert	Output Voltage Limit Level 1	<div style="display: flex; justify-content: space-between; font-size: small;"> V/f CL-V/f OLV CLV AOLV OLV/PM AOLV/PM CLV/PM EZOLV </div> Sets the voltage limit level in output voltage limit control. Usually it is not necessary to change this parameter.	0.95 (0.50 - 1.50)
nA-11 (1BF8) Expert	Output Voltage Limit Level 2	<div style="display: flex; justify-content: space-between; font-size: small;"> V/f CL-V/f OLV CLV AOLV OLV/PM AOLV/PM CLV/PM EZOLV </div> Sets the voltage limit level in output voltage limit control. Usually it is not necessary to change this parameter.	1.00 (0.50 - 1.50)

◆ Fine Tuning during Test Runs

nA-11 [Output Voltage Limit Level 2] has been added to parameters that are used in fine tuning during test runs in the Open Loop Vector Control for PM mode, Advanced Open Loop Vector Control Method for PM mode and Closed Loop Vector Control Method for PM Control mode. (Underlined parts in the table below are added items)

◆ A1-02 = 5 [PM Open Loop Vector]/A1-02 = 6 [PM Advanced Open Loop Vector]/A1-02 = 7 [PM Closed Loop Vector]

Issue	Parameter Number	Possible Solutions	Default Setting	Recommended Setting
<u>When the motor base frequency is exceeded, the output voltage exceeds the motor rated voltage.</u>	<u>nA-11 [Output Voltage Limit Level 2]</u>	<u>Increase the setting in 0.10-unit increments.</u>	1.00	<u>1.10 - 1.30</u>